

# ANTISUYUPA SUMAK KAWSAY 20



SHUTIKUNA:

AYLLUSHUTIKUNA:

LLIKA:

IKWYP.:



## **Unidades de aprendizaje**

**Primera edición:** 2010

### **Subsecretaría de Diálogo Intercultural del Ministerio de Educación**

Telf... (022) 921435

Fax... (022)923402

[www.educación.gov.ec](http://www.educación.gov.ec)

### **DINEIB**

Av. Amazonas entre Av. Atahualpa y Juan Pablo Sanz, Edif. Ministerio de Educación 6º Piso

Telf... (593) 023-961356

Fax: (593) 023-.....

[www.dineib.edu.ec](http://www.dineib.edu.ec)

[dineib@ecuanex.net.ec](mailto:dineib@ecuanex.net.ec)

### **Autores:**

Carmela Catalina Cerda Tapuy - NAPO

Cumanda Tapuy Shiguango - NAPO

Eduardo Efraín Licuy Tapuy - NAPO

Kenedi Alberto Licuy Tapuy – NAPO

Inés Edeline Coquinche Shiguango – NAPO

Gabriel Pedro Alvarado Andy – NAPO

Domingo Carlos Grefa Chimbo – NAPO

Patricio Aguinda – NAPO

Rita Mery Grefa Andi – ORELLANA

Mery Regina Alvarado Pauchi – ORELLANA

Natanael Bolívar Andi Díaz – ORELLANA

Pedro Domingo Andy Vargas - DIPEIB- Napo

Silvia Ivonne Aragón Gayas– Pastaza

Iván Edison Castillo Guerrón– Pastaza

Luis Shilve Tanguila Avilez– Pastaza

Cuji Margoth de Lourdes – Pastaza

Lucas Marcelo Grefa Cerda - Napo

Edison Felipe Hidalgo Cadena– ISPEDIB - Canelos

María Isabel López– Pastaza

Lorenzo Noteno – Sucumbíos

Rogelio Shiguango – Sucumbíos

Santiago Nicolás Tapuy Andi - Napo

Nestor Raúl Canelos Vargas – Pastaza

Raúl Gregorio Grefa – PASTAZA

### **Equipo Técnico Dineib**

Andrés Guaman Paucar

Luis Montaluisa

Virginia de la Torre

### **Dirección Pedagógica**

Jaime M Gayas  
Fernando Yanez

### **Coordinación Institucional**

### **Revisión de Estilo y Asesoría Técnica**

Pedro Domingo Andy Vargas

#### **Revisión:**

Fernando Jonas Shiguango - ORELLANA  
Samuel Clemente Andi Cerda - SUCUMBÍOS  
Eduardo Edmundo Shiguango Andi - SUCUMBÍOS  
Luis Miguel Yumbo Alvarado - ORELLANA  
Javier Rubén Díaz Cerda - ORELLANA  
Néstor Raúl Canelos Vargas- PASTAZA  
Inés Edelina Coquinche Shiguango- NAPO  
Gabriel Pedro Alvarado Andy- NAPO

### **Diseño Gráfico e Ilustración**

#### **Fotografía portada**

Direcciones Provinciales Interculturales Bilingües de la Nacionalidad Kichwa del  
Amazonia

#### **Nº de ejemplares:**

#### **Imprenta:**

#### **Impreso en:**

# RIKUCHIK

YACHAYKUNA	PANKAYUPA
Yuyashka	6
Kallarikyuyay	7
<b>20 SHUKLLAYACHISHKA: PACHAMAMA</b>	<b>8</b>
<b>Ñanyachay 1<sup>ki</sup> : Pachamama</b>	<b>9</b>
Paktaykuna	10
Yachayta Sinchiyachiy	11
Yachayta Rurariy	21
Yachayta Wiñachiy	23
Yachayta Willachiy	25
Shimikuna	26
Pushay Kamaykunamanta Killkapallak	27
Yachay Katina Kamaykunamanta Killkapallak	28
<b>Ñanyachay 2<sup>ki</sup> : Pachamama</b>	<b>29</b>
Paktaykuna	30
Yachayta Sinchiyachiy	31
Yachayta Rurariy	43
Yachayta Wiñachiy	49
Yachayta Willachiy	49
Shimikuna	50
Pushay Kamaykunamanta Killkapallak	51
Yachay Katina Kamaykunamanta Killkapallak	52
<b>Ñanyachay 3<sup>ki</sup> : Pachamama</b>	<b>53</b>
Paktaykuna	54
Yachayta Sinchiyachiy	55
Yachayta Rurariy	65
Yachayta Wiñachiy	68
Yachayta Willachiy	68
Shimikuna	69
Pushay Kamaykunamanta Killkapallak	70
Yachay Katina Kamaykunamanta Killkapallak	71
<b>4<sup>a</sup> Guía: La Naturaleza</b>	<b>72</b>
Objetivos	73
Dominio del Conocimiento	74

Aplicación del Conocimiento	85
Creación del Conocimiento	88
Socialización del Conocimiento	88
Vocabulario	89
Ficha de Evaluación de las Actividades	90
Ficha de Seguimiento y Evaluación del Conocimiento	91
Ficha de Avance por Unidades	92
<b>Taripashkamu</b>	<b>93</b>

## YUYASHKA

Katinakunaman kawsana samiman yaykuna shuk mushuk pachata wawakuna wanrakuna paktakta wallpankapak, yachanapi yaykurinami kururianapak, wiñanapak, aycha, ruray, yuyaypash pukurita runashina kachu nishpa ruranami kan, wankurinapi, akllaripi yachanakuna atinapipash sapiyashpa chay shina: yachanamanta sinchiyachina, rurana, wallpana, riksichina kamarinapash yachanamanta.

Nitik yachana samikunata pakinaka, shuk makarimi kan, tukuy yachachik paktachisha nishka, shuk runa ayllu pachapi ayllullaktapipash ruraypurashina yachakukta yuyarishka, pushak, yanapachik, ushayachik, ilunyachik, atikyachik katinlla kuskayachikpash kashpa chay tukuy yanaparichikta sumak rurayman ushayman tikrarinkapa kuskakta rimashpa paypa willana, kuyuyachiykunata, yachaykunata kuyachiktapash yacharishkata shinchiyachinkapak, llakikunata allichinapi paypa kikin ushaykunawan, shinchiyaykunawan rurarishkakunawanpash runa paktakta kururiankapak.

Yachana munayka, kawsankapak runa wallparinami kan, kikinllata paypak kikin ima sami llakikunata allichik tukunkapak yanaparin.

Yachanapi ima sami mutsurishkakunata, yachachik atipashkawan rurashkakuna, yachakukkuna kawankapak, llankankapak, rimankapak, riksinkapak, chikanyachinkapak, taripankapak yachana ruraypura mutsurik yuyayta akllankapakpashmi yanaparin.

Antisuyupi kikin runa Ishkay Shimipi Kawsaypura Yachay Samika, yuyaykunapi, paktanakunapi, paktachinakunapi, yachayñan muskuykunapi wankuchisha llikayachishkami kan, mushuk yachanakunata, ushaykunata, kikin ruku yuyaypi, kikin kawsaypi chanichishpa yachachinami kanchik.

Antisuyu Markakunamanta Ishkay Shimipi Kawsaypura Yachana Wasi, Marka Umachak, llankakuk yachachik mashikuna Hawaman Sikankapak Katinata ayllullaktakuna mañashka shina yuyaywan, yachanapi sumakyachisha yanapak ÑANYACHAYTA, kikin shimipi, kawsanakunamanta yuyaykunata pallashpa ÑANYACHAYKUNATA rurankapak ushayta kushka.

Kay Ruranakuypura Yachanata Alli Yachachina Ñanyaychayka, kikin yachanakunapi yanapak ñanyachaymi kan, ima sami runa yachay llikakuna, runakuna kikin kawsaypi ñanpikunatami chaskin, ima shina hatun yachana yuyay taripay tukuy pachapi mirarishka shinallatami kan.

Ñanyachaypi tiyak alli sumak yachanakunaka, runakuna pachamamawan sumak, llutalla rantiparishpa kawsashkakunatami chanichishkawan riksichin, kaykunami astawan kikin shimipi, kawsaykunapi yachana kuskakuna shayarin, kichwa runakuna tukuylla yanapashkawan pakllashpa, ima sami wakllichik nitikkunata arkashpami, wawakuna kikin chushaklla kawsana ñanpita paskakrinchik.

ANTISUYUPI WANKURISHPA KILLKAK AMAWTAKUNA

# KALLARIKYUYAY

Kay Yaykuchishka Ruranakuypura Yachanata Alli Yachachina Shukllayachishpa Allichishkaka, Ecuador Mamallaktamanta Antisuyupi Ishkayshimita katik ayllullaktamanta Yachana Pampakunapi, payta kikinlla rimakpika Antisuyu Markakunapi, Ishkayshimipi Kawsaypura Yachana Llikata sumakyachinamanmi yuyachin.

Yachayta chaskina chusku katiklla kashkakunamanta nikichishkaklla katisha ruranakunata kururiashka, 20 shukllayachishkamanta yachakukkuna shuk chikan ñanyachaykunapi llankashka yachanakunamanta taripayta, wallpayta yachayta chaskinatapash yachapanata llikchachichun nishpa, puchukaypi paypak ayllu, ayllullakta wakikunapash kawsaypi yachanakunata shinchiyachina riksichichunpash nishpami ushayta chaskichin.

Kay shukllayachishka ruranakuypura yachanaka 4 ñanyachaypi wankuchishkami kan: Ñanyachay 1<sup>ki</sup> Kichwapi, Ñanyachay 2<sup>ki</sup> Kichwapi Ñanyachay 3<sup>ki</sup> Kichwapi ,4<sup>a</sup> Guía en Castellano. Kay ñanyachaykunami yachachik yachakukkuna yanaparisha yuyarishpa, kikin mutsurishkawan rurarishkawan yapankapakmi chanirin.

Kay alli yachachina ñanyachaykuna yachanakunaka mana chayllawan yachachun nishpa nitinchu, ranti, shuk kallarik yanapaywallatami yachachin maykan mutsurikkuna taripasha usharikpika allichisha katinkapak.

ANTISUYUPI WANKURISHPA KILLKAK AMAWTAKUNA



# 20 SHUKLLAYACHISHKA

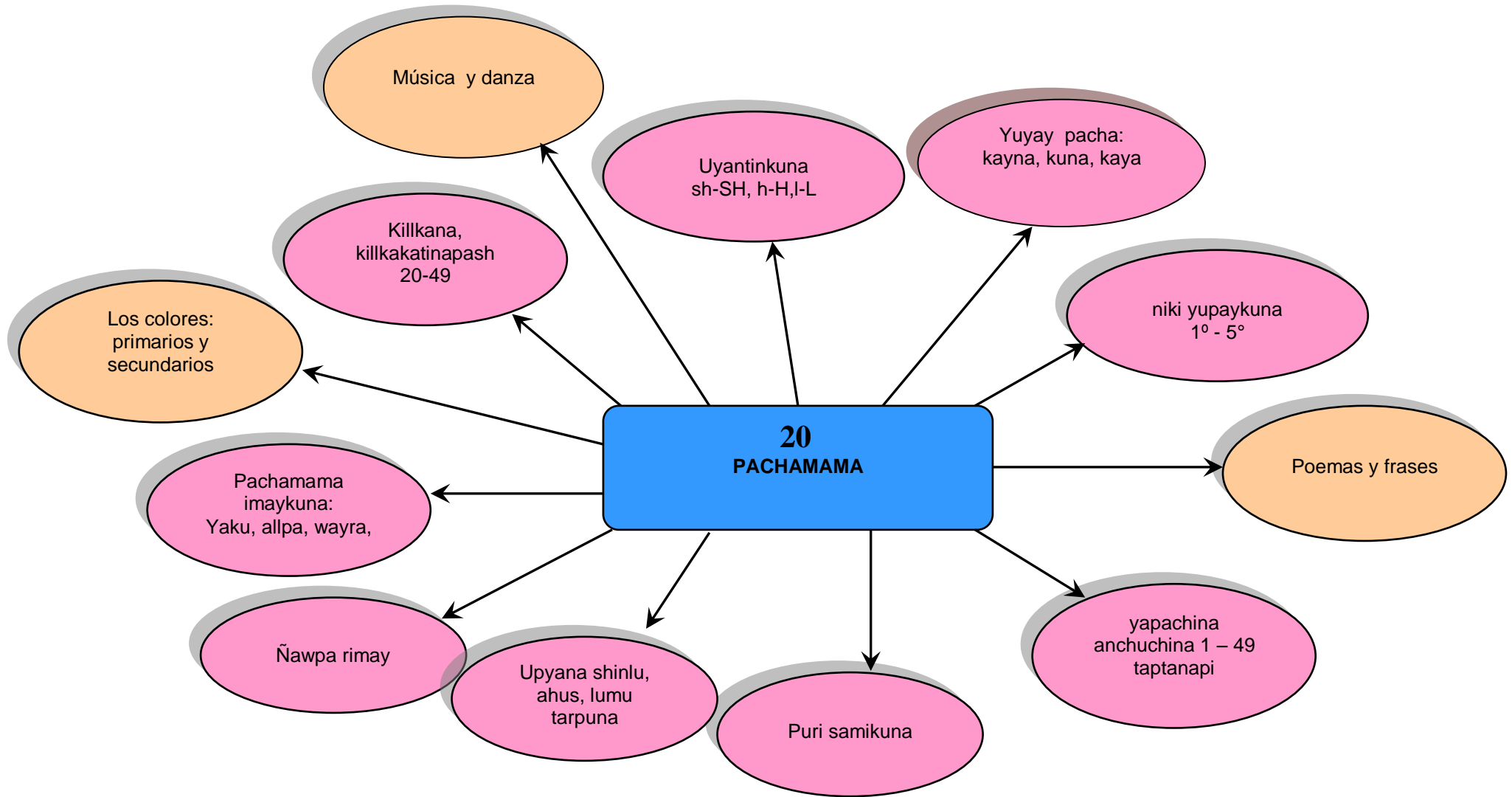

# ÑANYACHAY 1<sup>ki</sup>

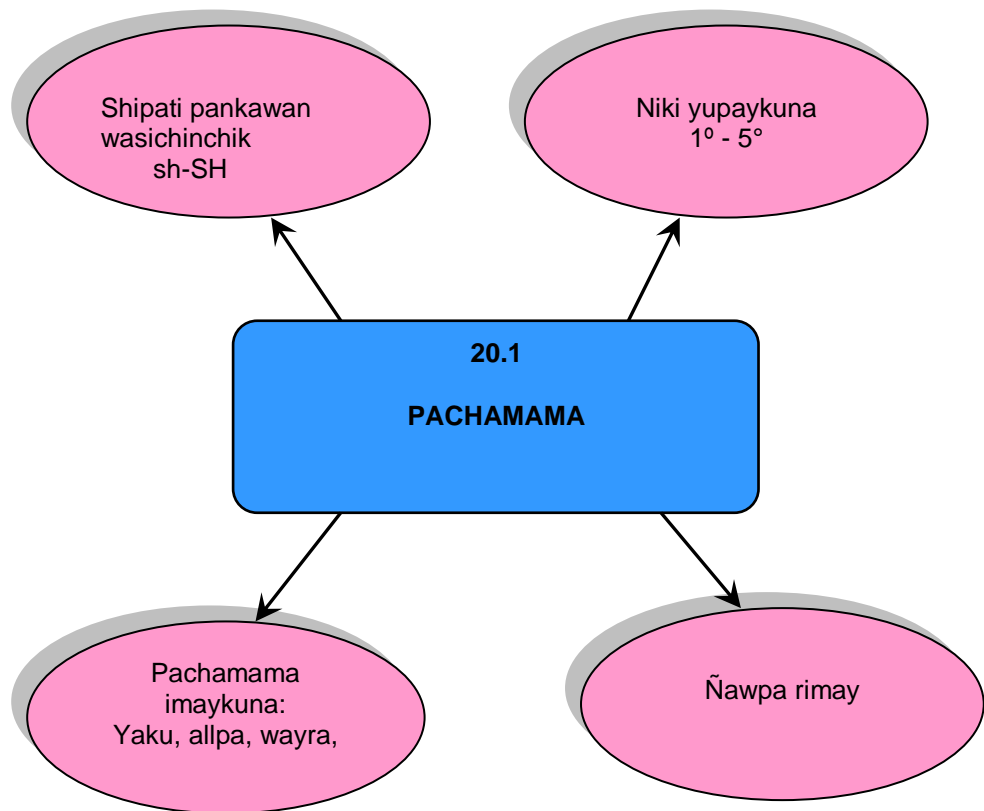



### **PAKTAYKUNA**

- SH - sh, uyantinkunata, niki yupaykunatapash killkashpa yachachini.
- Pachamama imaykunata, ñawpak rimaytapash uyashpa kikinyachini.



# YUYAY LLIKA

## A. YACHAYTA SINCHIYACHIY

1. Ayllupak sachaman shipati yurata rikunkapak lluksinchik.
  2. Wasimayapi tiyak sachá hukuman yaykushpa kawani.
  3. Purishkapi rikushkamanta shutichinchik.
  4. Rikushkamanta kashka rimana.
  5. Purishkamanta rimarini.
  6. Aychawakunaka maypita kawsankuna.
  7. Yurakunata rikurkankichu.
  8. Sacha ukupi sumak kawsanallachu.
  9. Kuyllur kallari rimaymanta willarina.
10. Yuyayta killka katishpa hamutarishun.

## Sachapimi **shipati** wiñan



# Sachapimi **shipati** wiñan

- **Sachapimi shipati wiñan.** (ashka kutin rimashpa maki waktashkawan yachankaman katini)

- **Kawani.**

- Yuyay rikuchik shimikunapi pitishpa chawsichini.

**sachapimi / shipati / wiñan.**

- Yuyay rikuchikta killkashpa wasichishun.

**Sachapimi** **shipati** **wiñan**

- Pitipankakunata chimpapurashun.

Sachapimi

shipati

wiñan

- Piti shimikunata rikushpa taripashkawan yupana.

Sachapimi

**shipati**

Wiñan

1°

2°

3°

- Sapan Wawakunaman piti killkata makichini, kallarik yuyayta killkashpa pitinkapak. Alliman, waklliman churashpa rikunkapak.
- Maki rukakunallawan imakunapish yachashka uyantinkunata killkani. **Sh**
- Yachashka /**sh** / uyantinwan shimikunata rimashun.
- Shimikunata pitishpa yuyachishun.

**sa/ cha / pi/mi / shi /pa / ti**

**wi / ñan**

- Yuyay rikuchikpi shimikunata, yupashun.

sachapimi

shipati

wiñan

1°

2°

3°

Sa	cha	pi	mi	shi	pa	ti	wi	ñan
1°	2°	3°	4°	5°	6°	7°	8°	9°

- **Sh** /Yachashka uyantinkunata rumpachishun.

shaman	yaku	shikitu
wayra	shinlu	allpa
Shirly	kuyllur	shuntu
shikra	shiwa	shulla
Shiltipu	shuwa	shun

- Pishik niki yupakunata paktachishun.

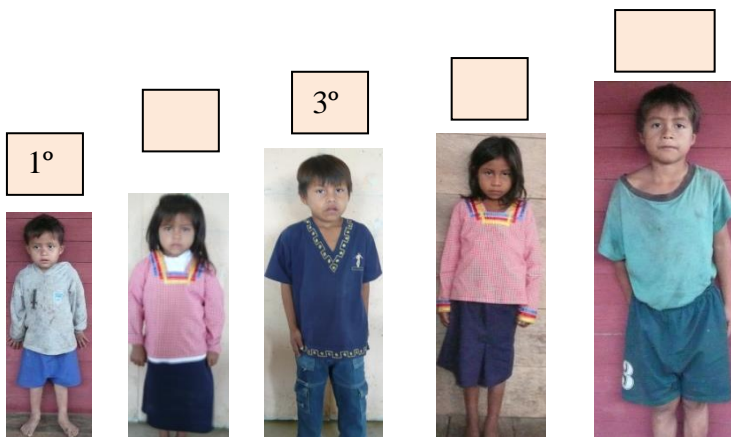

Luís

Shirly

Daniel

Rosa

Pushak

- Kikin kashkata rikushpa tinkichishun.



- Shutikunata shimikunawan llutachishpami wallpashun.

## Sachapimi **shi**pati wiñan

sa/cha/pi/mi / **shi**/pa/ti / wi/ñan.

--	--	--	--

--	--	--

--	--



- Killpakipimi killkashun.

sh

sh

sh

sh

sh

sh

**Sh**

**Sh**

**Sh**

**Sh**

**Sh**

**Sh**

<b>sh</b>	<b>sh</b>	<b>sh</b>	<b>sh</b>	<b>sh</b>
<b>Sh</b>	<b>Sh</b>	<b>Sh</b>	<b>Sh</b>	<b>Sh</b>

Wallpariy



- Yachashkata wankuchishun.

**Sachapimi**

**shipati**

**wiñan**

**Sachapimi shipati wiñan**

- Yachaypi yanapakta rurana.



**Sh**ipati



**Sh**iyu



**Sh**ikra



**Sh**untu



**p**ishku



**Sh**irly

Shimiki.

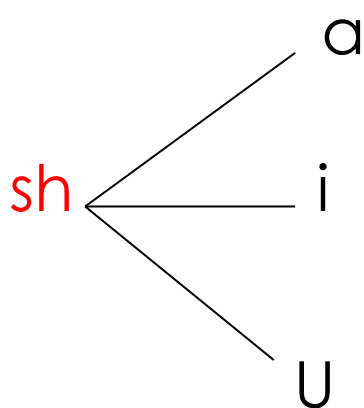

**Sh**irly



**sh**ipati



**sh**untu



- Pishik shimikita paktachishun.



	pa	ti
--	----	----

	tu
--	----

	ly
--	----

- Mushuk shimikunata wallpashpa kipalla killka katishun.



Shaman

Shipati

Shushunka

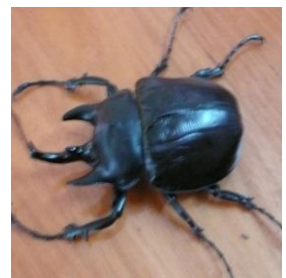

Shirly

Shimi

Shuntu



shikitu

shimpi

pishku

- Wichilla yuyaykunata wiñachinchik.

**Shipati sachapimi wiñan.  
Shipati pankawan wasini.  
Sachaka chiri wayratami charin.  
Allpapi murukunata tarpuni.  
Yurata shuntu uktun.**

- (10x10 u 8x8)Kuyuy piti kichwa killka llikata rurana.

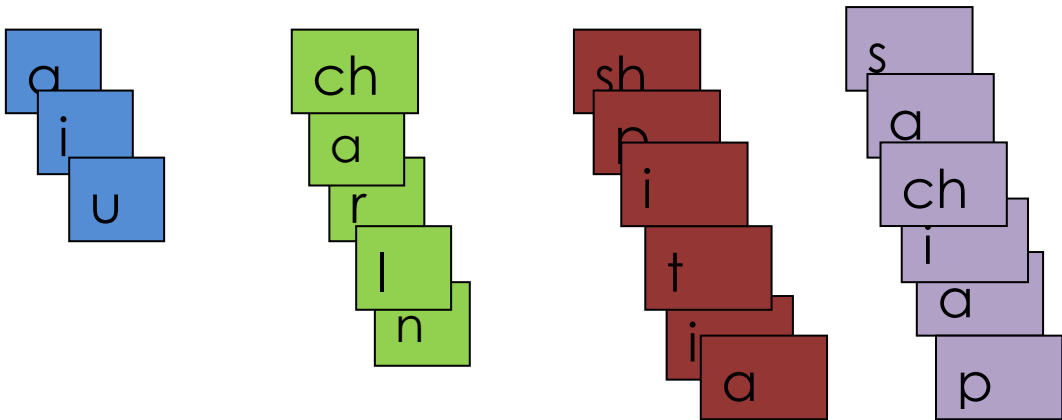

# CH. YACHAYTA RURARIY

- Pishik shimikikunata paktachishun.



			p	a	t	i
--	--	--	---	---	---	---



			n	t	u
--	--	--	---	---	---



			m	a	n
--	--	--	---	---	---



s	h	u				k	a
---	---	---	--	--	--	---	---

- Niki yupakunata killkashun.

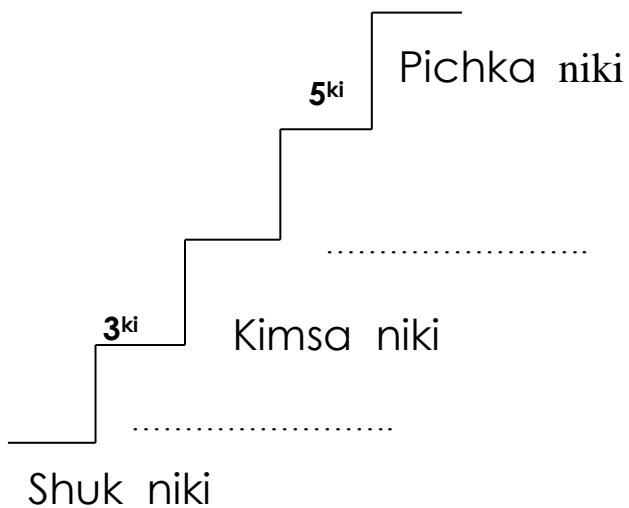

- Shuyushkawan, kikin shimiwan taripashpa tinkichishun.

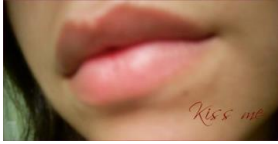

shushunka



shuntu



shaman



shimpi



shiyu



shimi

- sha , shi , shu shimikikunata rumpashun.

Shimi	shulla	shanshu	shinlu	shuwa
shamuy	shipati	pishku	pushka	shuti
shunku	masha	pashin	pawshi	chushak
shiltipu	mashi	mushuk		

## H. YACHAYTA WIÑACHIY

11. “sha, shi, shu” Yachashka shimikikuna manyata sachamuykunawan llutashun.

sho



s h i

S h y

**12. Nikikunata uchillamanta hatunkaman killkashun.**

2 <sup>ki</sup>	5 <sup>ki</sup>	1 <sup>ki</sup>	3 <sup>ki</sup>	4 <sup>ki</sup>
-----------------	-----------------	-----------------	-----------------	-----------------

.....	.....	.....	.....	.....
-------	-------	-------	-------	-------

**13. Allpapi, mayupi, wayrapipash tiyakkunata shuyushun.**



**14. Yachashkakunata, mashikunawan ayllukunawanpash rimarishun.**



## SHIMIKUNA:

<b>Allpa</b>	Tierra
<b>Kaway</b>	Observar
<b>Niki</b>	Ordinal
<b>Ñawpa rimay</b>	Cuento
<b>Shaman</b>	Curandero
<b>Shikitu</b>	Carachama
<b>Shinlu</b>	hierba luisa
<b>Shimi</b>	Boca
<b>Shipati</b>	Clase de palmera
<b>Shiwa</b>	Ungurahua
<b>Shiyu</b>	Variedad de carachama
<b>Shuyuy</b>	Dibujar
Uchilla	pequeño
<b>Tinkichiy</b>	Unir
<b>Wayra</b>	Aire
<b>Wichkay</b>	Encerrar
<b>Yaku</b>	Agua
<b>Yachay yuyay</b>	Frase generadora

### PUSHAY KAMAYKUNAMANTA KILLKAPALLAK

ÑANYACHAY: 1<sup>ki</sup>

SHUKLLAYACHISHKA: 20

SUKTAKILLAYACHISHKA: .....

Y <sup>a</sup>	SHUTIKUNA	RURAYKUNA																				PUNCHA		KAWANA					
		1	2	3	4	5	6	7	8	9	10	11	12	13	14	15	16	17	18	19	20	21	kallarik		Tukurik				

W.....  
YACHACHIK

W.....  
IKWYP. UMANCHA

W.....  
YACHAYKAWAK

# YACHAY KATINA KAMAYKUNAMANTA KILLKAPALLAK

YACHAYÑAN: 1<sup>ki</sup>

SHUKLLAYACHISHKA: 20

SUKTAKILLAYACHISHKA: .....

NIKI YUPA SHUTI AYLLUSHUTI	YACHANAKUN	KUYAYCHAY										YUYAYCHAY			RURAYCHAY												
	1	A	1	2	3	4	5	6	7	8	9	10	11	12	13	14	15	16	17	18	19	20	21	22	23	24	<b>KALLARISHKA PUNCHA</b>
		Ruranakunapi pachapichu kallarin	Yanapanchu	Mashikunata Sumaychanchu	Yachashkakunata yachachinchu	Kuskallachu	Kikinllata kuyarinchu	Shukpa yuyayta sumaychanchu	Paypa yayakunawan willarinchu	Yachachikkunawan willarinchu	Allita rimakchu	Sh uyantita riksinchu	Pachamamapi tiyak imakunamanta yachanchu	Niki yupakunamanta pichkakaman riksinchu	Ñawpa rimaykunamanta yachanchu	Pishik shimikikunawan paktachinchu	Shuyushka shimiwan taripshpa tinkuchinchu	Niki yupakunata killkanchu	Ichillamanta hatunma niki yupakunata killkanchu	Shuyushkakunata rikushpa paypura tinkuchinchu	Sha.shi.shu..shimikikunata rumpachinchu	Pachamamapi tiyakkunata shuyunchu	Sh uyantti mayanta killkashpa paktachinchu	sha ,shu,shi shimikikuna mayanta sachá muyuwan	Yachashkakunata mashikunawan willarinchu.		

W.....  
YACHACHIK

W.....  
IKWYP. UMANCHA

W.....  
YACHAYKAWAK

# ÑANYACHAY 2<sup>ki</sup>

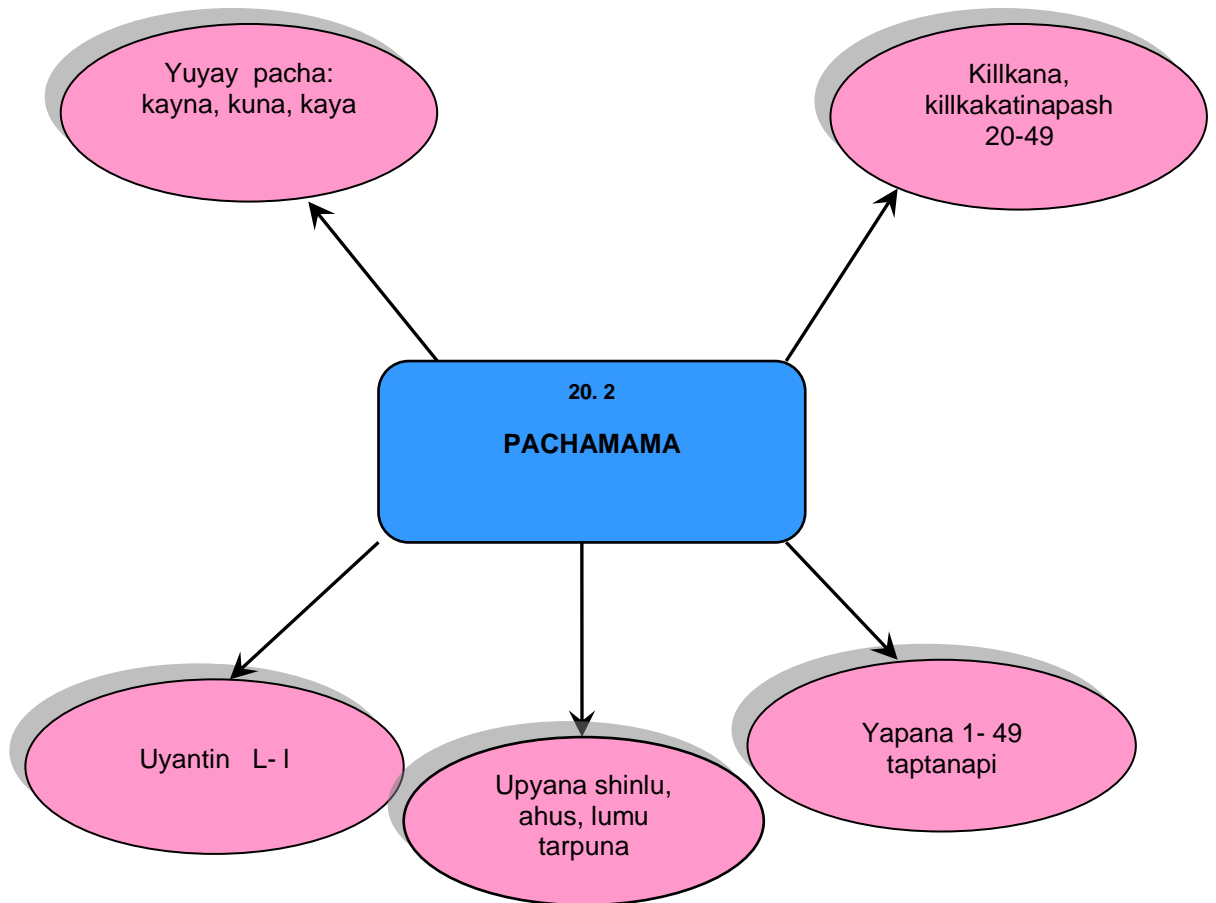



## PAKTAYKUNA

- Lumu, upyana shinlu, sachá ahustapash, chakrata llankashpa tarpushpami yachachini.
- Taptanapi, ish kay chunkamanta chuskuchunka iskunkaman yupakunata, yapashpa yachachini.

# YUYAY LLIKA

## A. YACHAYTA SHINCHIYACHIY

● Yachay kallariy

1. Shuk ayllu chakraman rishpa : lumu, upyana shinlu, sacha ahus rikunkapak llukshishunchik.
2. Rikushkamanta rimarina.
3. Chakrapi rikushkakunata shutichishun.
4. Takishunchik:

### Lumu Sisa Mamalla

Lumu sisa mamalla  
Llantu, llantu shayawnki  
Ashankata aparishpa  
Lumu siki shayawnki.



5. Chakrapi ima sami tarpukunata rikurkanki.
6. Masna lumu sapita surkurka.



● Yachay chawsiriy

## 7. Yachay yuyay

**Lumuta lumucha mikun.**



**Lumuta lumucha mikun.**

- **Lumuta lumucha mikun** (ashka kutin rimashkawan katishun)
- Yuyay rikuchikta shimikunapi pitishpa chawsichishun.

**Lumuta / lumucha / mikun.**

- Yuyay rikuchikta killkashpa wasichishun.



**Lumuta** lumucha mikun

- Piti shimikunata rikushpa taripashkawan chimpapurashun.

**Lumuta** **lumucha** **mikun.**

- Piti shimikunata rikushpa taripashkawan yupashpa yachashun.

**Lumuta** **lumucha** **mikun.**

6 + 7 + 5

- Sapan wawakunaman pitikillkata makichini, kallarik yuyayta killkashpa pitinkapak. Alliman, waklliman churashpa rikunkapak.
- Maki rukallawan imakunapish yachashka uyantikunata killkashun.
- **L - l** Yachashka uyantita maskashpa yachashun.
- Shimikunata pitishpa yuyachishun.

**Lu/ mu/ ta**

**Lu**

**mu**

ta  
 lu/ mu/ cha  
 lu  
 mu  
 cha  
 mi/ kun  
 mi  
 kun

- Yuyay rikuchik shimikunapi, killkakunata yupashun.

Lumuta      lumucha      mikun  
 6       + 7       + 5

Lu	mu	Ta	lu	mu	cha	mi	kun
1	2	3	4	5	6	7	8

- . L - I Yachashka uyantikunata rumpachishun.

lumucha	lalu	kayna	lumu
kuna	pacha	lupi	lisan
ahus	liki	maki	liw
lunkutsu	linchik	pulu	kalamatu
shinlu	puka	lita	pillpintu

● Shutikunata shimikunawan llutachishpa wallpashun.

Lu/mu/ta

lu/mu/cha

mi/kun

--	--	--

--	--	--

--	--

● Killpakipi killkashun.

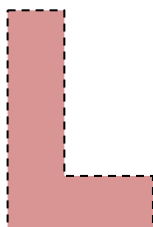
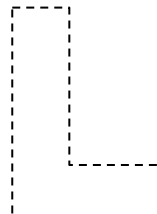
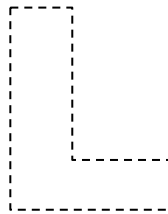
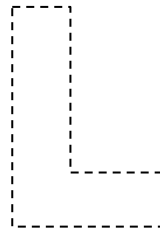
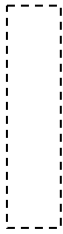

I	I	I	I	I
L	L	L	L	L
L	L	L	L	L

I	I	I	I	I
I	I	I	I	I

8. Umayuyachikta rurashun.

**L**umuta **l**umucha mikun



**L**umuta **l**umucha mikun.

- Yachaypi yanapakta rurashun.



lumucha



lumu



lalu





pillpintu



lulun



lisan



Lila



Lucas



Lulú

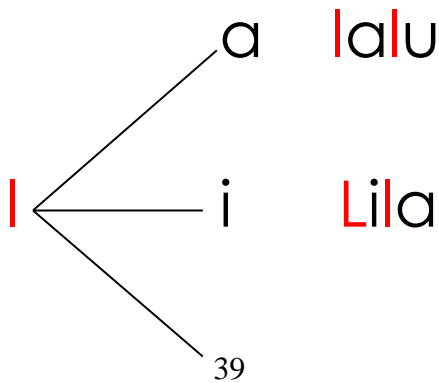

u lulun

● Killkashun.

<b>la</b>	<b>li</b>	<b>lu</b>
<b>La</b>	<b>Li</b>	<b>Lu</b>

<b>lumu</b>	<b>lisan</b>	<b>lalu</b>
<b>Lila</b>	<b>Lucas</b>	<b>Lulú</b>

● Pishik shimikita paktachishun.



.....	<b>san</b>
-------	------------



.....mu cha

.....	la
-------	----

- Mushuk shimikunata wallpashpa kipalla killka katichishun.

Shinlu            lita            pillpintu            lalu

lumucha        lisan        lapu                Lucas

kalamatu        lumu        lupi                lawa

- Wichilla yuyaykunata wiñachishun.

**Lumuta lumucha mikun.**

**Lumucha.....**

**Lumucha sachapi kawsan.**

**Lumu aswata upyani.**

- Yuyaychaputa rurashun.

- (10x10 u 8x8) Kuyuy kichwa killka llikata rurashun.

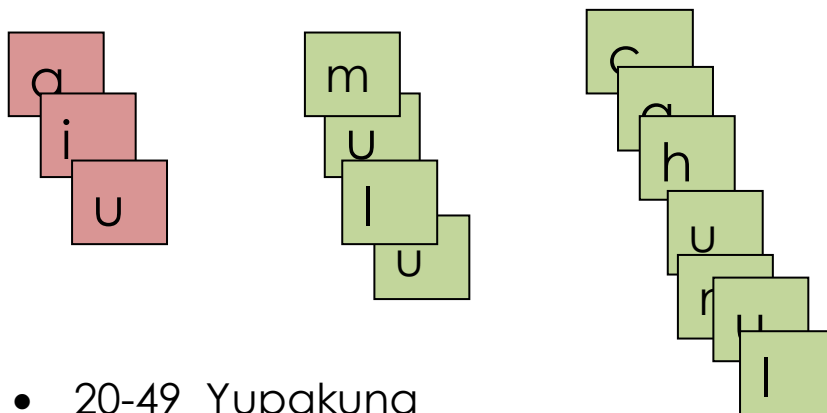

- 20-49 Yupakuna

19



30



- Yupakunata killkakatishun.

20	21	22	23	24	25	26	27	28	29
30	31	32	33	34	35	36	37	38	39
40	41	42	43	44	45	46	47	48	49

- Shukmanta chusku chunka iskunkaman yapashun.  
Lucas, ish kay chunka pichka lulunkunata chakramanta pitishpa apamurka, paypak mama apamurka chunka ish kay lulunkunata. Masna lulunkunata tantarirka.

# Taptana Nikichik

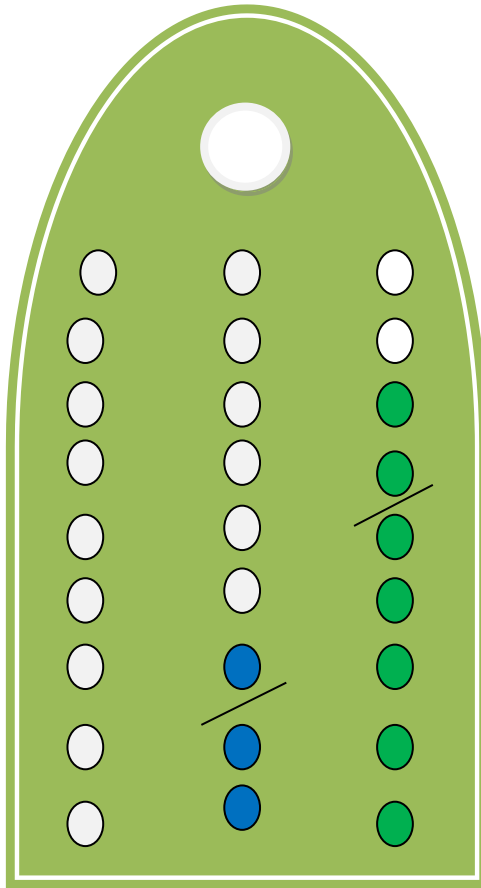

+

2	5
1	2
3	7

## ● Upyana shinlu, ahus, lumu tarpuna



Ima sami tarpunata munashpaka allpata akllanami, kipaka sumakta llankana; mama lumu kaspita pakishpa allpata wankawan uktushpa tarpun. Shinallata, lumu pukunkama kiwata pichashpa charin.

**Upyana asna shinlu**, paypak panka sumak asnakmi kan, yanushpa upyankak, shinallatak, hampirinkapak mutsurin, shinakpimi wasi manyapi chakrakunapi tarpuna.

**Sacha ahus**, ima sami unkuykunata hampirinkakmi ashkatami mutsurin, chaymantami tarpushpa charina.



## CH. YACHAYTA RURARIY

9. /L/ /l/ **uyantin kallarichik shimikunata shuk kamukunapi maskashpa, pitishpa kay millka ukupi llutashun.**



10. Shutikunata rikushpa shuyushun.

lumu



lalu



lulun



11. Shuyukunawan , shimikunata rikushpa tinkichishun.

lunkutsu



lalu



lumucha



limun



12. Shuyushkakunata yupashpa yupata killkashun.

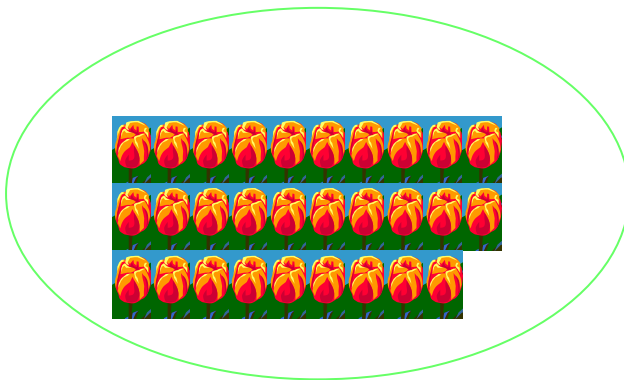
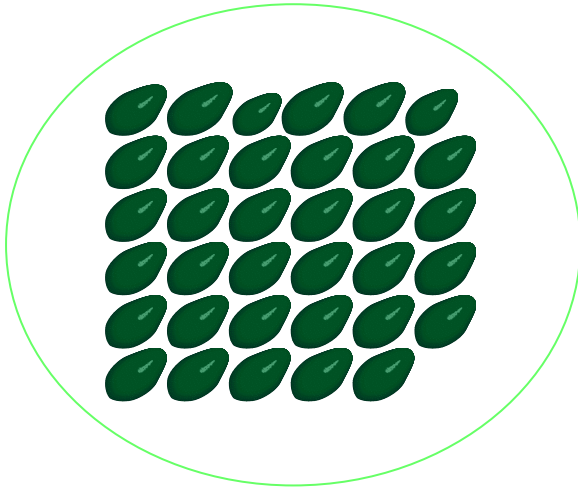
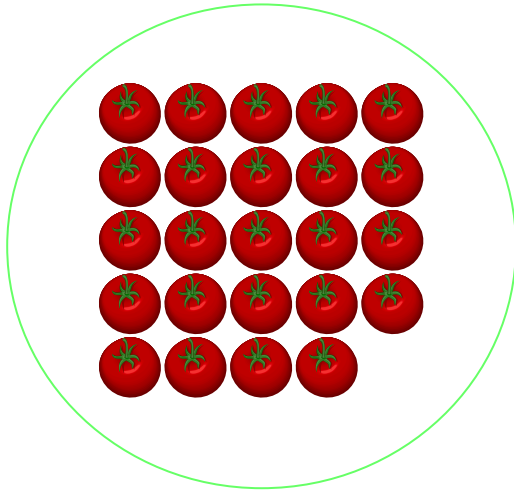

**13. Yupakunata rikushpa nipakunata shuyushun.**

29

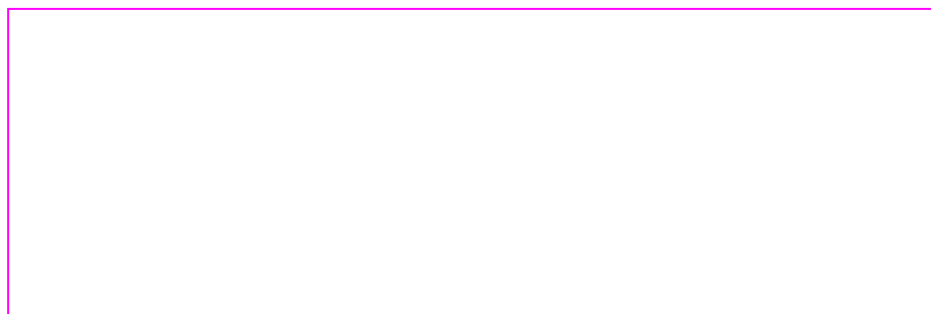

35



49

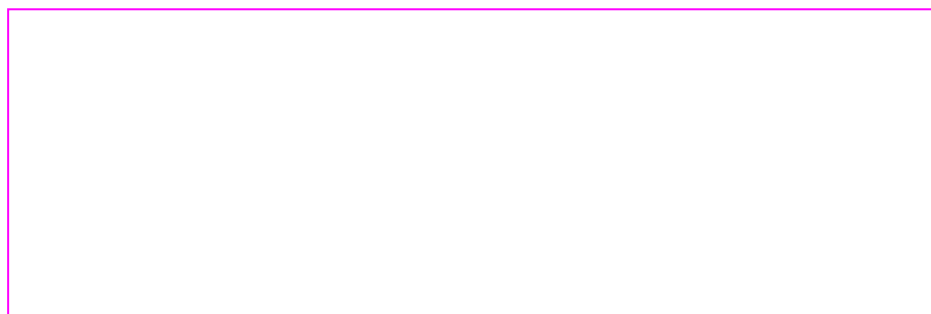

**14. Pishik yupakunata chushakkunapi killkashpa paktachishun.**

15. Chikan, chikan shuyukunata yupashpa, yapanata rurashun.

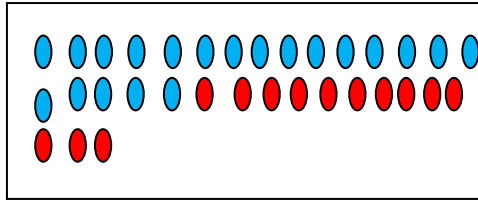

+

2	0
1	3

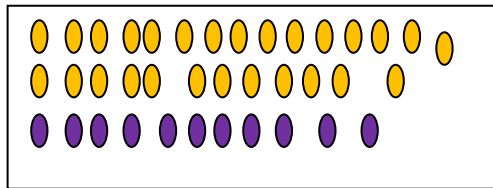

+

2	7
1	1

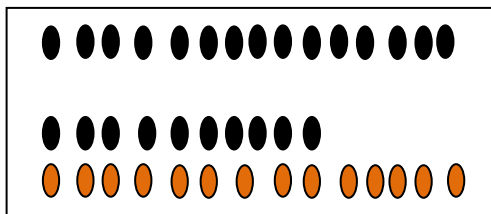

+

3	5
1	4

16. Yapaykunata rurashun.

20	21	.....	.....	24	.....	.....	.....	.....	29
.....	.....	32	.....	.....	35	.....	.....	38	.....
40	.....	.....	43	.....	.....	.....	47	.....	.....



Lucas mayuma rishpa ishkay chunka kanchis challuwakunata apirka, paypak yaya ishkay chunka shuk challuwakunata apirka. Masna challuwakunata tantachirka.

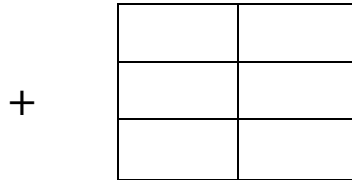

**17. Yapachiykunata, llukshichishka yupakunawan tinkichishun.**

$$26 + 23 = 47$$

$$24 + 24 = 35$$

$$32 + 15 = 49$$

$$25 + 10 = 48$$

**18. Upyana asnak shinluta shuyushun.**

**19. Kayna, kuna, kaya pacha rikuchik shuyukunata pitishpa kay millkapi llutashun.**

20. Yuyachik katupi shimikunata maskashpa wishkashun.

lumu, lisan, Lulú, Lila

k	t	l	u	m	u	L
t	L	i	l	a	i	u
v	s	s	h	s	z	l
l	p	a	n	m	ñ	u
a	w	n	ñ	n	f	s



21. Ichilla taptanawata shuyushun.

22. Lumu kaspi, upyana shinlu, sachá ahus  
maskashpa yachana wasi manyapi  
tarpushun.

## I. YACHAYTA WILLACHIY

23. Yachashkakunamanta mashikunaman kikin ayllukunawanpash rurashpa riksichishun.

### SHIMIKUNA:

Ahus	Ajo
Asnak shinlu	Hierba luisa
Hawiy	Pintar
Kallari rimay	Cuentos
Kuskapaktani	Puntualidad
Kuyaychay	Afectivo
Limun	Limón
Lisan	Paja toquilla
Lulun	Huevo
Lumu	Yuca
Lumucha	Guanta
Lunkutsu	Clase de pez
Pushaykamay	Evaluación de actividades
Ruraychay	Psicomotriz
Tinkichiy	Unir
Yuyaychay	Cognoscitivo
Yuyay Ilika	Sistema del conocimiento



## PUSHAY KAMAYKUNAMANTA KILLKAPALLAK

ÑANYACHAY: 2<sup>ki</sup>

SHUKLLAYACHISHKA: 20

SUKTAKILLACHISHKA: .....

Y <sup>a</sup>	SHUTIKUNA	RURAYKUNA																									PUNCHA		KAWANA											
		1	2	3	4	5	6	7	8	9	10	11	12	13	14	15	16	17	18	19	20	21	22	23	24	25	Kallarik	Tukurik												
	A.....								A.....										A.....																					
	YACHACHIK									YACHAY	PUSHAK										YACHAY	TARIP																		

W.....  
YACHACHIK

W.....  
IKWYP. UMANCHA

W.....  
YACHAY KAWAK

## YACHAY KATINA KAMAYKUNAMANTA KILLKAPALLAK

ÑANYACHAY: 2<sup>ki</sup>

SHUKLLAYACHISHKA: 20

SUKTAKILLAYACHISHKA: .....

	NIKI YUPA	YACHANAKUNA		KUYAYCHAY							YUYAYCHAY					RURAYCHAY																	
		SHUTI	AYLLUSHUTI																														
1				1	2	3	4	5	6	7	8	9	10	11	12	13	14	15	16	17	18	19	20	21	22	23	24	25	26				
				Ruranakunapi pachapichu kallarin	Yanapanchu	Mashikunata sumaychanchu	Kikinlata kuyarinchu	Shukpa yuyayta sumaychanchu	Yachashkakunata yachachinchi	Kuskallachu	Paypa yayakunawan willarinchi	Yachachikkunawan willarinchi	Allita rimakchu	L . l uyantinta riksinchi	20 – 49 yupakunata yachanchu	Taptanapi 1-49 yapanata yachanchu	Kayna, kuna, kaya pachakunamanta riksinchi	Shinlu, ahus, lumu tarpunamanta yachanchu	L- l uyantita maskashpa pitishpa llutanchu	Shutikunata rikushpa shuyunchu	Shuyushkawan shimiwan tinkichinchi	Shuyushkata yupashpa yupata killkanchu	Yupakunata rikushpa nipata shuyunchu	Pishik shimikunapi killkashpa paktachinchi	Shuyushpa paktachinchi	Sha ,shu,shi shimikikuna manyata sachamuyuwawan llutanchu	Yapachikkunata yupakunawan tinkuchinchi	Taptanata shuyunchu	Yachana wasi manyapi ahus,shinlukunata tarpunchu	KALLARISHKA PUNCHA	CHASKICHISHKA PUNCHA		

W.....  
YACHACHIK

W.....  
IKWYP. UMANCHA

W.....  
YACHAYKAWAK

# ÑANYACHAY 3<sup>ki</sup>

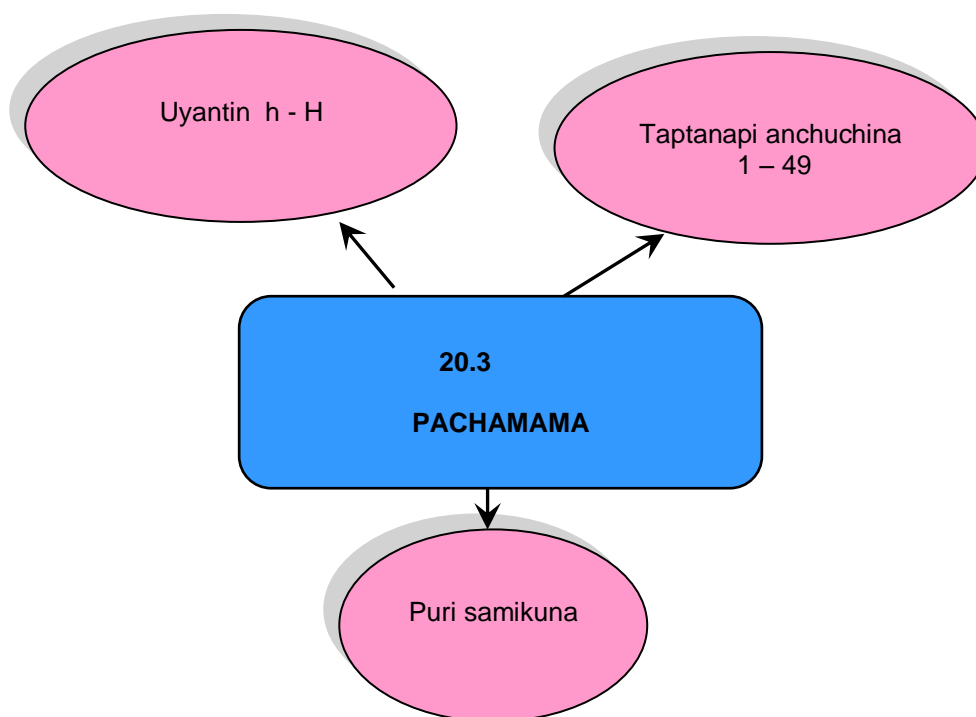



**PAKTAY:**

- H-h uyantinwan, purina samikunata, yupa anchuchinamantapash killka katishpa, killkashpa kichushpa yachachini.



# YUYAY LLIKA

## A. YACHAYTA SHINCHIYACHIY

### ● Yachay kallari

1. **Yachana wasi manyata puririshunchik.**
2. **Purishkamanta rimarishunchik.**
3. **Rikushkakunata shutichishunchik.**
4. **Tapushkata kutipani.**

a. Kay wiwa shutikunata shutichishun.



ch. Imakunata tantachishpa, kipalla kichushpa pukllashun.

h. Pukllashkamanta chakunashun.

i. Puchushkakunata yupashun.

k. Rikushkamanta yuyayta llukchishun.

● Ychay chawsiriy

5. Yuyayta killka katishpa hamuktarishun.

## Sachapi **h**ampatu pawan



## Sachapi **h**ampatu pawan

- Sachapi hampatu pawan. (ashka kutin rimashpa, maki waktashkawan katishun).
- Yuyay rikuchikta shimikunapi pitishpa chawsichishun.

## Sachapi / **h**ampatu/ pawan

- Shimikunata chimpapurashun.
- Yuyay rikuchikta killkashpa wasichishun.

**Sachapi** **h**ampatu **pawan**

- Pitipankakunata chimpapurashun.

<b>Sachapi</b>	<b>hampatu</b>	<b>pawan</b>
----------------	----------------	--------------

- Pitipankakunapi shimikunata yupashpa kipalla kichushun.

<b>Sachapi</b>	<b>hampatu</b>	<b>pawan</b>
----------------	----------------	--------------

7 + 7 - 5

- Sapan wawakunaman piti killka pankakunata makichini, pitinkapak. Alliman, waklliman churashpa rikunkapak.

<b>Sachapi hampatu pawan</b>
------------------------------

<b>Sachapi</b>	<b>pawan</b>	<b>hampatu</b>
----------------	--------------	----------------

<b>pawan</b>	<b>hampatu</b>	<b>sachapi</b>
--------------	----------------	----------------

- Maki rukallawan imakunapish yachashka uyantinkunata killkashun.

**H**

**h**

- **h H** Yachashka uyantinwan shutikunata rimashun.
- Shimikunta shimikikunapi pitishun.

**ham/ pa / tu**

**ha**

**h**

**a**

**ha**

- Yuyay rikuchikpi shimikuna killkata yupashpa anchuchishun.

S a c h a p i h a m p a t u p a w a n

<b>Sachapi</b>	<b>hampatu</b>	<b>pawan</b>
----------------	----------------	--------------

7

+

7

-

5

- Yachashka uyantinta rumpashun.

h

H

hampatu	shipati	hihi	pillpintu	hatun
hampi	hutku	Hilda	raku	humpi
allku	Hugo	maki	Héctor	aswa

- Shutikunata shimikunawan llutachishpa wallpashun.

**Sachapi hampatu pawan**

**Sa/cha/pi / ham/pa/tu/ pa/wan**

--	--	--

--	--	--

--	--

- Iñukunata llutachishpa uyantinta paktachini(pirkapi) kipalla killpakipi killkashun.

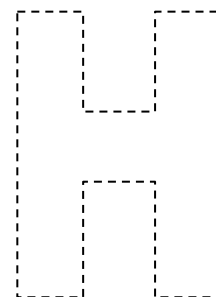
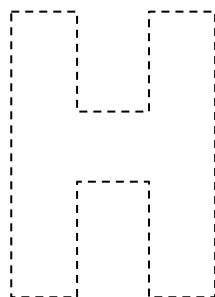
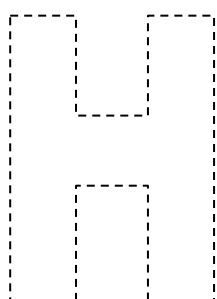
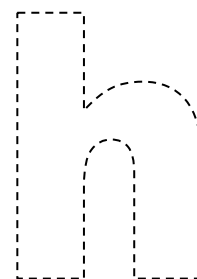
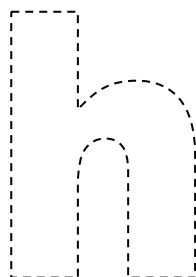
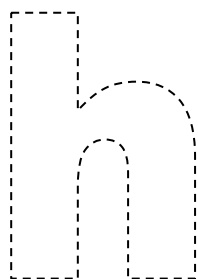

<b>h</b>	<b>h</b>	<b>h</b>	<b>h</b>	<b>h</b>

<b>H</b>	<b>H</b>	<b>H</b>	<b>H</b>	<b>H</b>

- Wallpariy

## 6. Yachashkata wankuchishun.

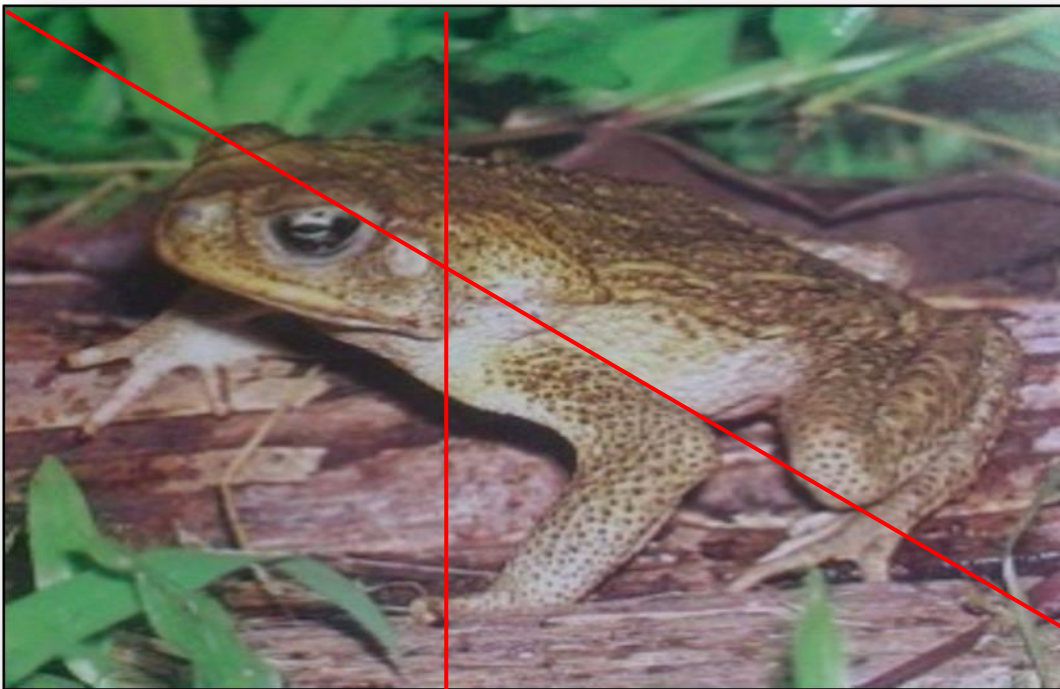

## Sachapi hampatu pawan

- Yachaypi yanapakta rurashun.



a hampatu



h — u Hugo  
 h — i hihi



- Kay shimikiki killkashkakunta rikushpa killkashun.

ha	hi	hu
<b>hampatu</b>	<b>hihi</b>	<b>humpi</b>
<b>Ha</b>	<b>Hi</b>	<b>Hu</b>
Hugo	Hilda	Héctor

- Pishik shimikita paktachishun.



•

	hi
--	----

	go
--	----

- Mushuk shimikunata wallpashpa killkashun.

hihi          humpi          hampatu

.....

- Uchilla yuyaykunata wiñachishun.

**Sachapi hampatu pawan.**

**Hihi** .....

**Hugo** .....

.....

- Yuyaychaputa rurashun.

- (10x10 u 8x8) Kuyuy kichwa killka llikata rurashun.

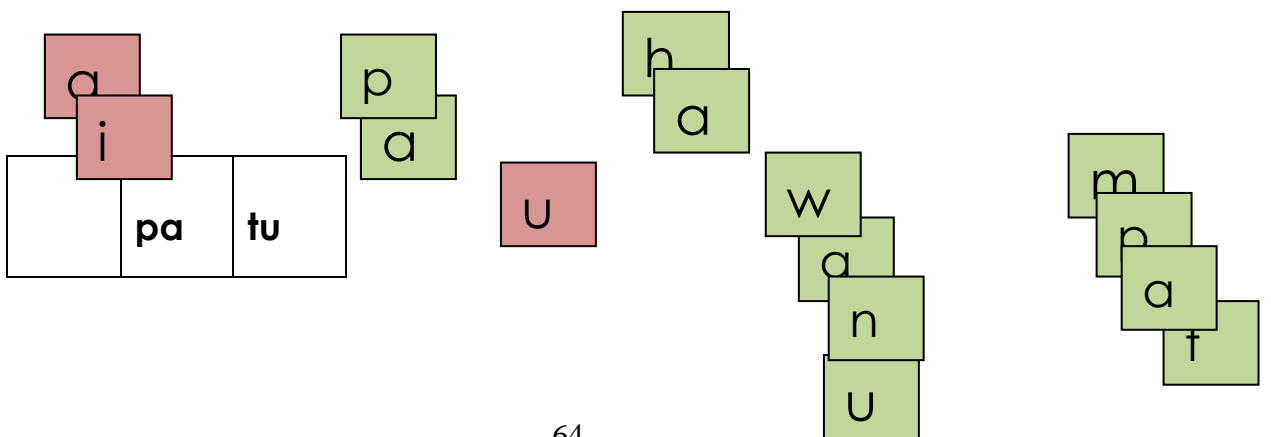



- Anchunchina 1- 49

Hilda 36 hampatukunata sachapi tupashpa apamushka shikrapi watashpa wakachirka, chaymanta ishkay chunka hampatukuna llukshishpa rinakushka. Masna hampatukunata puchurka.

### Taptana Yupachik

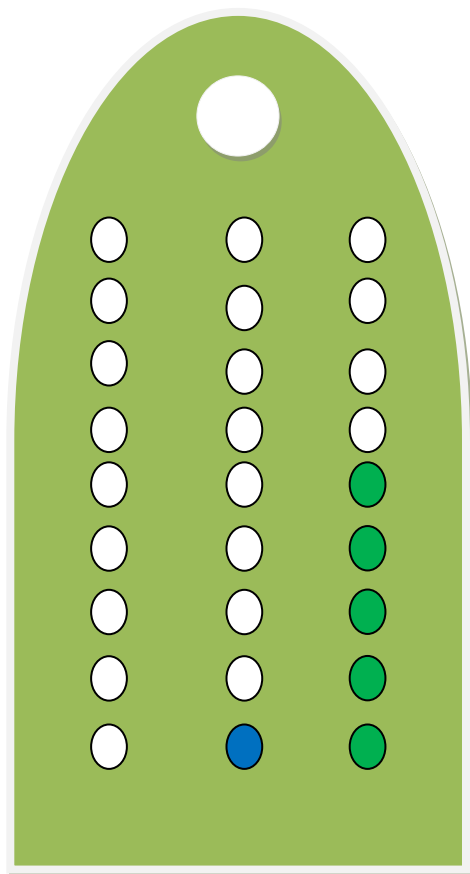

–

3	6
2	1
1	5

## Sacha ñanpita purini



Kay pachapi tukuykuna maykan puramas puririshpami kawsanchik; shinallatak, kichwa runakuna sacha ñanpita purinchik. Ñukanchik wawakunata sumaklla kamachinami kanchik, ama imapish susurinkanpak; ñanpita purishpa mana kallpashpa rinachu, niktashpa ama urmankapak; shinallatak, kashapi, kaspipi aytanamanta, utkupi urmanamanta; milli wiwakunamantapash kishpinkapak, kasnami tukuykuna riparashkawan purina kanchik.

## CH. YACHAYTA RURARIY

7. /h/ uyantinta chushakpi killkashpa paktachishun.

\_ampatu

\_ihi

\_ampi

\_ugo

\_ilda

8. /h/ /H/ uyantinta, kamumanta pitishpa llutashun.



9. Shimikunawan, shuyushkakunata finkichishun.

hihi



hampi



hampatu



10. Killkashka shimita rikushpa shuyushun.

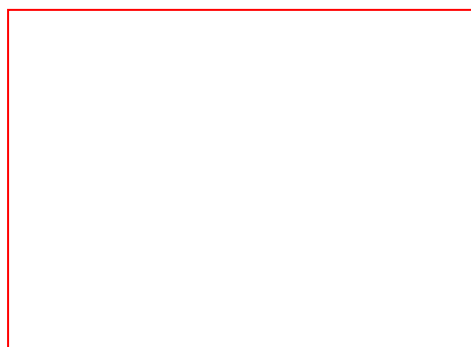
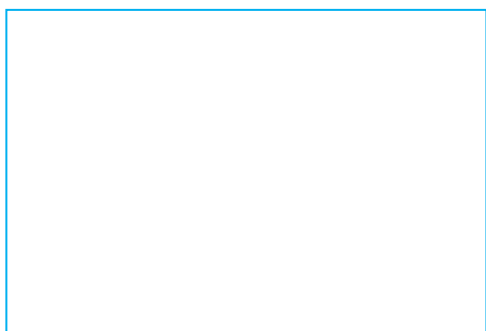

hampatu

hihi

**11. Millkapi yupakunata killkashpa, anchuchinakunata llukshichishun.**

- Katy 26 limunkunata pitishpa wasiman apamun, chaymanta 13 limunkunata paypak yachachikman kuyarka. Masna limun muyukunata puchun.

—

- Sisa payaka 37 atallpa lulunkunata sachá ukupi tarirka, wasiman apamushkapi 22 lulunkuna pakirishka. Masna lulunkunawan sakirirka.

—

- Yarina payaka 45 papaya muyukunata pitishpa tasapi wasiman apamurka, chaymanta, 34 muyukunata katurka. Masna papaya muyukunata puchurka.

—

## **H. YACHAYTA WIÑACHIY**

12. Sachapi rikushkakunata, /h/ uyantin shutiwan kallarik wiwakunatapash, yuyaychaputa rurashun.

## **I. YACHAYTA WILLACHIY**

13. Rurashkakunata mashikunaman willarishpa chimpachishun.



<b>Anchunchiy</b>	Restar o quitar
<b>Chakuy</b>	Diferenciar/distinguir
<b>Chimpapuray</b>	Comparar
<b>Hampatu</b>	Rana
<b>Hampimuyu</b>	Pastilla
<b>Hihi</b>	Grillo
<b>Kahali</b>	Variedad de barbasco
<b>Llutay</b>	Pegar
<b>Nipak</b>	Elemento
<b>Paya</b>	Niña /hija.
<b>Pitiy</b>	Cortar
<b>Pitipankaku</b>	Tarjeta
<b>Puriy</b>	Caminar
<b>Sacha</b>	Selva
<b>Shuyuy</b>	Dibujar
<b>Tariy</b>	Encontrar objeto.
<b>Tinkichiy</b>	Unir
<b>Yuyaychapu</b>	Collage

PUSHAY KAMAYKUNAMANTA KILLKAPALLAK

ÑANYACHAY: 3<sup>ki</sup>

SHUKLLAYACHISHKA: 20

SUKTAKILLAYACHISHKA: .....

Y <sup>a</sup>	SHUTIKUNA	RURAYKUNA																														PUNCHA		KAWANA								
		1	2	3	4	5	6	7	8	9	10	11	12	13	14	15	16	17	18	19	20	21	22	23	24	25	26	27	28	29	30	Kallarik	Tukurik									

W.....  
YACHACHIK

W.....  
IKWYP. UMANCHA

W.....  
YACHAYKAWAK



## YACHAY KATINA KAMAYKUNAMANTA KILLKAPALLAK

ÑANYACHAY: 3<sup>ki</sup>

SHUKLLAYACHISHKA: 20

SUKTAKILLAYACHISHKA:.....

	<b>NIKI YUPA</b>	<b>YACHAYKUNA</b>		<b>KUYAYCHAY</b>										<b>YUYAYCHAY</b>					<b>RURAYCHAY</b>										
		<b>SHUTI</b>	<b>AYLLUSHUTI</b>																										
<b>1</b>				1	2	3	4	5	6	7	8	9	10	11	12	13	14	15	16	17	18	19	20	22	23	24	25		
				Ruranakunapi pachapichu kallarin	Yanapanchu	Mashikunata sumaychanchu	Kikinlata kuyarinchu	Shukpa yuyayta sumaychanchu	Yachashkakunata yachachinchu	Kuskallachu	Paypa yayakunawan willarinchu	Yachachikkunawan willarinchu	Allita rimakchu	Taptanapi anchuchinata yachanchu	Puri samikunata yachanchu	H , h uyantinkunata riksinchu	Shukmanta chushku chunka iskunkaman anchuchinata yachanchu	Shuyushkata rikushpa killkanchu	Pishik shimikikunata killkanchu	Killkashka shimita rikushpa shuyunchu	Taptanapi anchuchinchi	Iñukunata katishpa paktachinchi	Pishik uyantinkunata killkanchu	H-h uyantita kamumanta pits'ha llutanchu	Shimikunawan shuyushkawan tinkichinchi	Yupakunata taptanapi anchuchinchi	Yuyaychaputa ruranchu	<b>KALLARISHKA PUNCHA</b>	<b>CHASKICHISHKA PUNCHA</b>

W.....  
**YACHACHIK**

W.....  
**IKWYP. UMANCHA**

W.....  
**YACHAYKAWAK**

## 4ª GUÍA

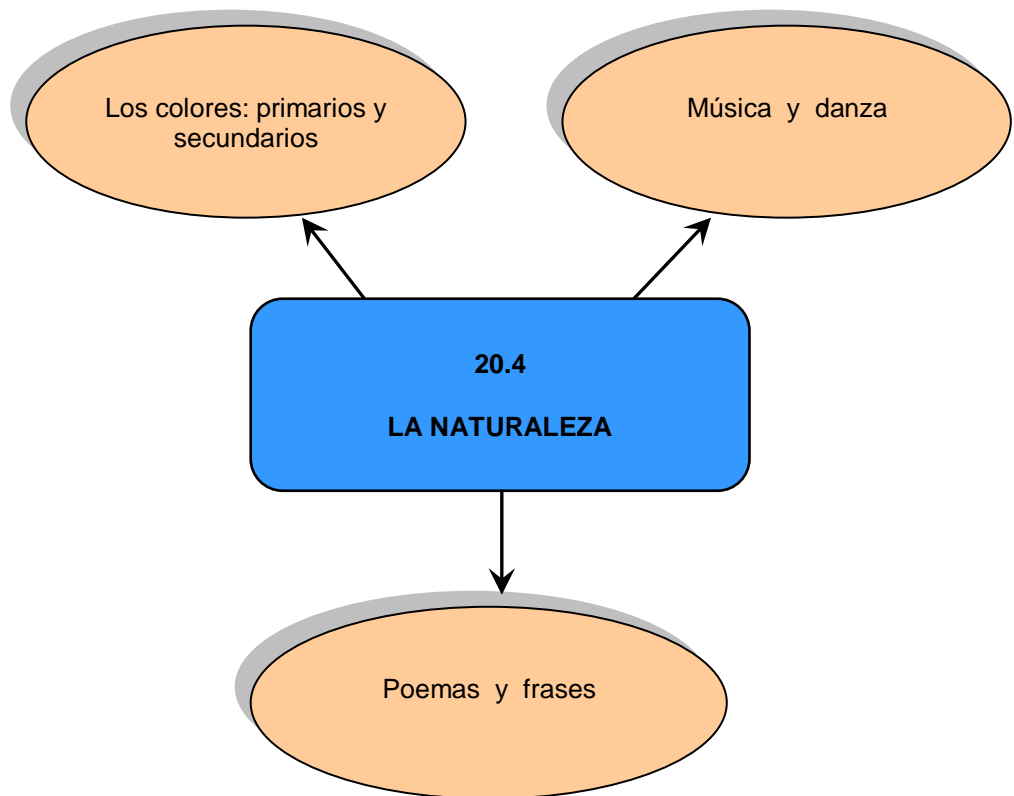



### **OBJETIVOS:**

- Identificar los colores primarios y secundarios en los objetos y figuras existentes en el medio.
- Demostrar la música, danza, poemas, frases con la expresión corporal, oral y escrita .

# SISTEMA DEL CONOCIMIENTO

## A. DOMINIO DEL CONOCIMIENTO

### 1. Observemos los gráficos.



2. Comentemos sobre lo observado.
3. Nombremos los elementos observados.
4. Describamos los objetos mediante los sentidos.

5. Declamo un poema.



**Banderita Ecuatoriana**

Amarillo, azul y rojo  
Mi bandera ecuatoriana  
Yo te amo y te saludo  
Porque soy del Ecuador

6. **Respondo las siguientes preguntas.**

a. Pinto las siguientes figuras con los colores primarios.

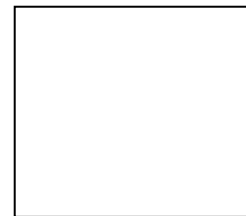
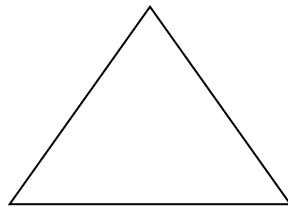
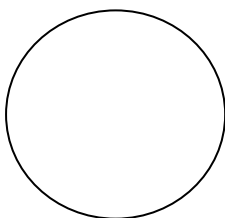

b. Pinto las caras con los colores de los gráficos

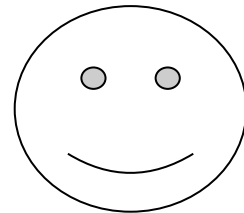
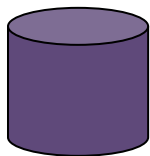
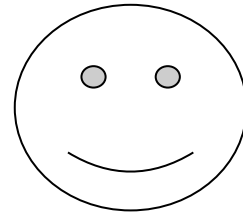
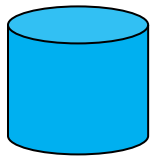
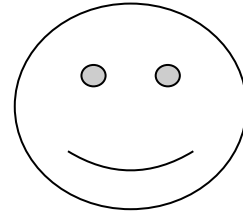
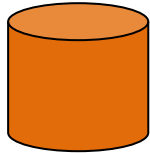
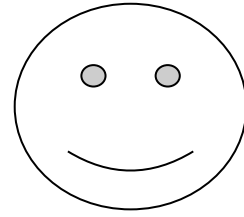
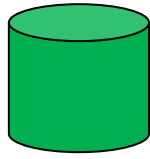

c.  
bandera

Coloreo la

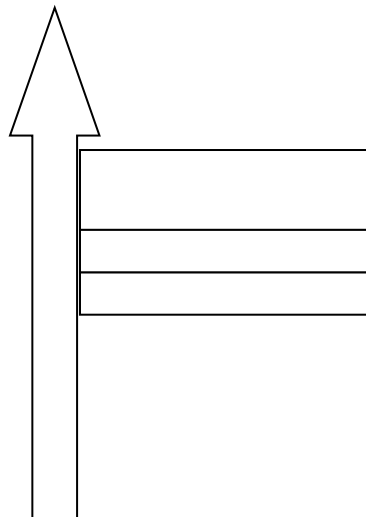

d. Completo la frase:

Amar es.....

e. Escribo el titulo de la siguiente poesía.



.....

Amarillo, azul y rojo  
Mi bandera ecuatoriana  
Yo te amo y te saludo  
Porque soy del Ecuador

f. Encierro la respuesta correcta, la siguiente danza es de la:

- a. Región Sierra
- b. Región Amazónica
- c. Región Costa



# 7. NUEVOS CONOCIMIENTOS

## Los colores primarios

Amarillo

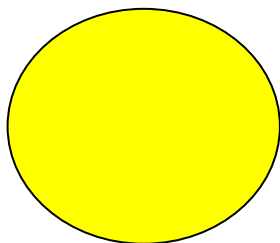

Azul





Rojo

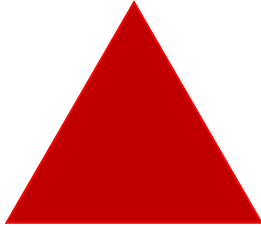

Colores secundarios

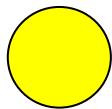

+



=

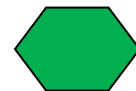

Amarrillo

azul

verde



+



=

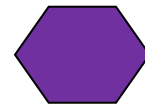

Azul

rojo

morado



+

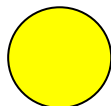

=



Rojo

amarillo

anaranjado

Colores primarios + colores secundarios =

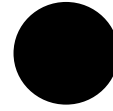

Aprendo las frases:

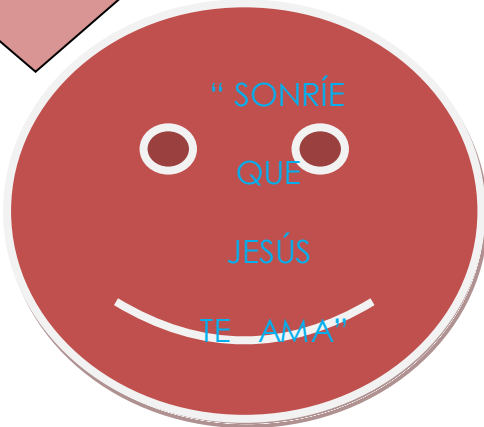

Poema a la bandera



**Banderita Ecuatoriana**  
Amarillo, azul y rojo  
Mi bandera ecuatoriana  
Yo te amo y te saludo  
Porque soy del Ecuador



## Los sapos

// Los sapos en la laguna  
    Cuando cae el aguacero//  
// Los chiquitos con camisa  
    Y los grandes con sombrero//

### CORO

Por ahí se fue y se perdió  
Por ahí se fue y se perdió

// La sapa estaba cociendo  
    del sapito los calzones//  
// La sapa se las cose  
    Y el sapito se los pone//

## La danza

### Danza cultural de la serranía

Vestimenta: alpargata,  
falda ancha y larga, blusa  
floreada, pañuelo, faja de  
colores, pantalón blanco,  
camisa blanca, poncho y  
sombrero.



## **Danza de la Amazonia.**

Vestimenta: Típica, con pepas, hojas de materiales del medio.



8. Respondo las siguientes preguntas:

a. En las siguientes figuras pinto con los colores primarios.

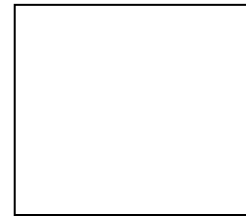
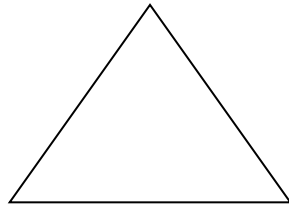
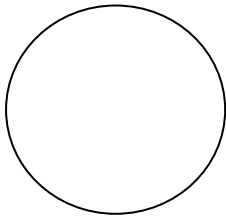

b. Pinto las caras con los colores de los gráficos

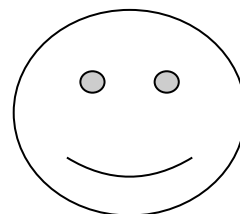
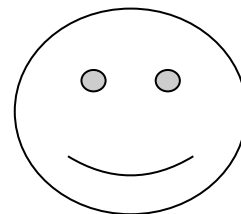
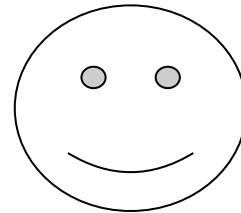
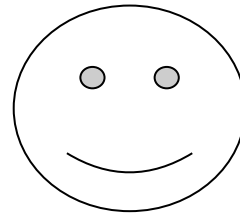
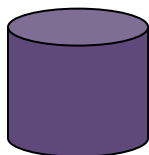
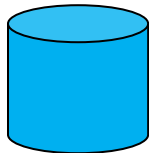
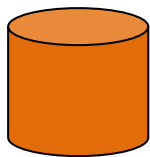
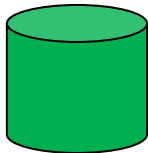

c.  
bandera

Coloreo la

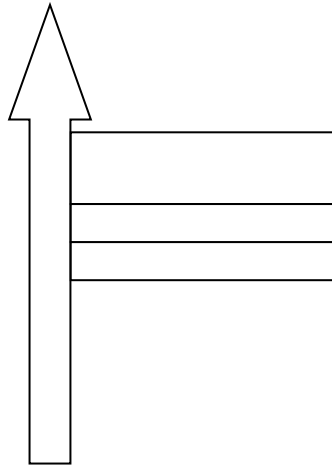

d. Completo la frase:

Amar es.....

e. Escribo el titulo de la siguiente poesía.



.....

Amarillo, azul y rojo  
Mi bandera ecuatoriana  
Yo te amo y te saludo  
Porque soy del Ecuador

f. Encierro la respuesta correcta, la siguiente danza es de la:

- a. Región Sierra
- b. Región Amazónica
- c. Región Costa



**B. APLICACIÓN DEL CONOCIMIENTO**

**9. Relaciono con línea entre los colores primarios**

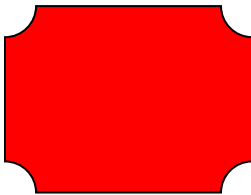
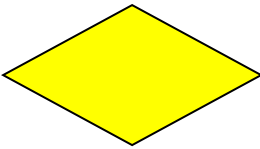
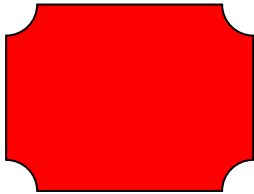
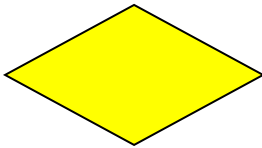

**10. Dibujo y pinto los siguientes:**

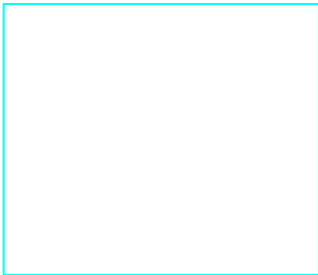

ají

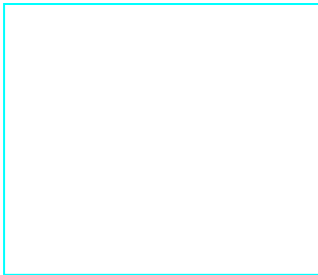

nube



Hoja

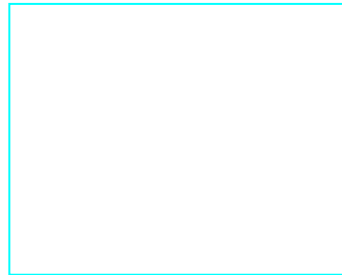

papaya

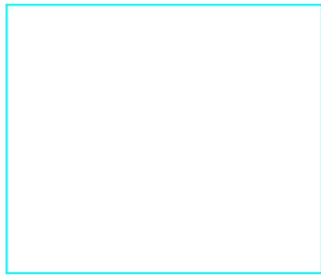

sol

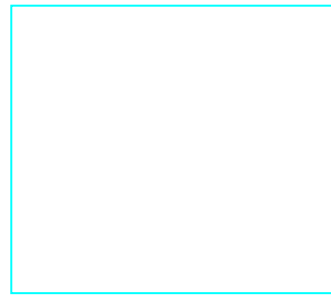

Uva

**11. Escribo las frases aprendidas.**

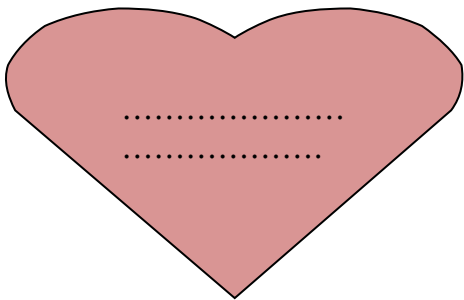



12. Uno con línea la danza con sus respectivas regiones



Sierra



Amazonia

13. Completo la poesía

**Banderita Ecuatoriana**

Amarillo,.....y.....  
Mi..... ecuatoriana  
Yo..... y ..... saludo  
Porque soy del .....

## C. CREACIÓN DEL CONOCIMIENTO

14. Mezclo y obtengo los colores secundarios.

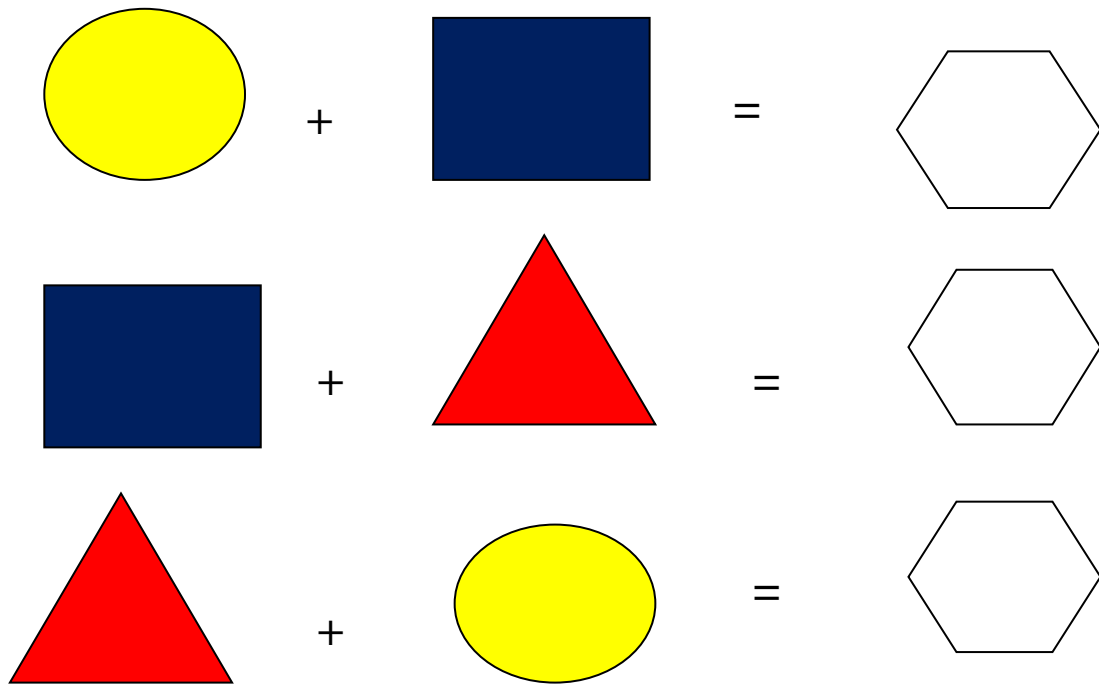

15. Creo una danza con una música autóctona.

## D. SOCIALIZACIÓN DEL CONOCIMIENTO

16. Presento ante mis compañeros la danza autóctona.

17. **Exhibo los trabajos realizados en la feria pedagógica organizado por el CECIB.**



## VOCABULARIO

**Colores primarios**  
**Colores secundarios**  
**Danza**  
**Graficar**  
**Memorizar**  
**Morete**  
**Música**  
**Papaya**  
**Poemas**  
**Ranas**

Colores fuertes y llamativos  
Colores suaves  
Baile de acuerdo a la música  
Representar figuras objetos.  
Fijar algo en la memoria.  
Palma del monte  
Ritmo de cada grupo social  
Familia de melón.  
Frases para declamar  
Clases de sapos



## FICHA DE SEGUIMIENTO Y EVALUACIÓN DEL CONOCIMIENTO

GUÍA: 4ª

UNIDAD: 20

SEMESTRE.....

No.	APELLIDOS Y NOMBRES	CONTENIDO	AFECTIVO										COGNOSCITIVO					PSICOMOTRIZ				FECHA						
			1	2	3	4	5	6	7	8	9	10	11	12	13	14	15	16	17	18	19	20	21	22	23	24	FECHA DE INICIO	FECHA DE APROBACION
1			Es puntual en sus actos	Es solidario	Respeto a los compañeros	Se autoestima	Respeto la opinión ajena	Comparte sus conocimientos	Es honrado/a	Dialoga con sus padres	Dialoga con sus profesores	Es honesto/a	Conoce los colores primarios	Identifica los colores secundarios	Sabe de que se trata el poema	Memoriza frases.	Diferencia la danza música.	Comparte los conocimientos con sus compañeros	Relaciona con líneas los colores primarios	Dibuja y pinta los gráficos con los colores primarios y secundarios	Mezcla y obtiene los colores secundarios	Escribe la frase	Relaciona los colores con los gráficos	Practican la danza creada	Completa la poesía con las frases que faltan	Une la danza con las regiones corresponden		

f.....  
PROFESOR

f.....  
DIRECTOR/A DEL CECIB

f.....  
SUPERVISOR



## BIBLIOGRAFÍA

ANDY VARGAS PEDRO D., 2008. *Raíces Culturales de los Kichwas del Alto Napo*. Ediciones “Yachay Ushay”. Tena-Napo-Ecuador.

ANDY VARGAS, Pedro D., 2009. *Kichwapi Rimashun*. Hablemos en Kichwa. Consejo de Lengua Kichwa de Napo Ediciones Yachay Ushay. Tena Ecuador. pp 78.

ANDY VARGAS, Pedro D., 1999. *Kipukamana Pachamanta Español Kichwa Shimikuna*. Tena Ecuador.

CAMPAÑA., Klever., 2004. *Tantachishka Kichwa Shimi*. Guías Bilingüe de Aprendizaje Autónomo. Riobamba – Ecuador.

CERDA CH., Mariano y otros, 2007. *Shimiyuk Kamu*. Pastaza Marka Ishkay Shimi Yachayta Pushak. Primera Edición Puyo Ecuador.

CALDERÓN C. Luís H. *Dejando Huellas*, Segundo Año de Educación Básica.

MINISTERIO DE EDUCACIÓN, *Matemática*, Segundo Año de Educación Básica.

MINISTERIO DE EDUCACIÓN, *Entorno Natural y Social*, Segundo Año de Educación Básica.

MINISTERIO DE EDUCACIÓN, *Lenguaje y Comunicación*, Segundo Año de Educación Básica.