

PROYECTO



EDUCACION BILINGÜE INTERCULTURAL

# QUILLCAC CUNUCU

Quillca catincapac panca

Ishcai patapac



# Quillcac cunucu

---

Quillca catincapac panca  
Ishcai patapac

Edición Experimental

Proyecto de Educación Bilingüe Intercultural  
DINEIIB-GTZ

Quito, enero, 1991

QUILLCAC CUNUCU, Quillca catincapac panca, Ishcai patapac, El conejito escritor, Libro de lectura en lengua materna para segundo grado de educación primaria bilingüe intercultural.

---

ASESORIA: Ruth Moya, P. EBI

AUTORES: Ruth Moya, P. EBI  
Cristóbal Quishpe Lema, P. EBI  
Gilberto Inga, DINEIIB  
Alberto Conejo, DINEIIB  
Luis Avilés, CONAIE  
Humberto Lema, CONAIE

ILUSTRACION Y DIAGRAMACION: Edgardo Reyes

LEVANTAMIENTO DE TEXTOS: Mañana Editores

FOTOMECANICA: Scann Cromo

ILUMINACION: Krohma Publicidad

COORDINADOR NACIONAL  
DEL PROYECTO EBI: Luis de la Torre

ASESOR DEL PROYECTO EBI: Wolfgang Küper

© MINISTERIO DE EDUCACION Y CULTURA

DIRECCION NACIONAL DE EDUCACION INDIGENA INTERCULTURAL  
BILINGÜE (DINEIIB)

En cooperación con la Deutsche Gesellschaft für Technische Zusammenarbeit (GTZ)  
GmbH (Cooperación Técnica-República Federal de Alemania - GTZ)  
y Confederación de Nacionalidades Indígenas del Ecuador (CONAIE)

Se puede reproducir total o parcialmente, citando la fuente.

Papel donado por CODE - Canadá

Impreso en Ecuador

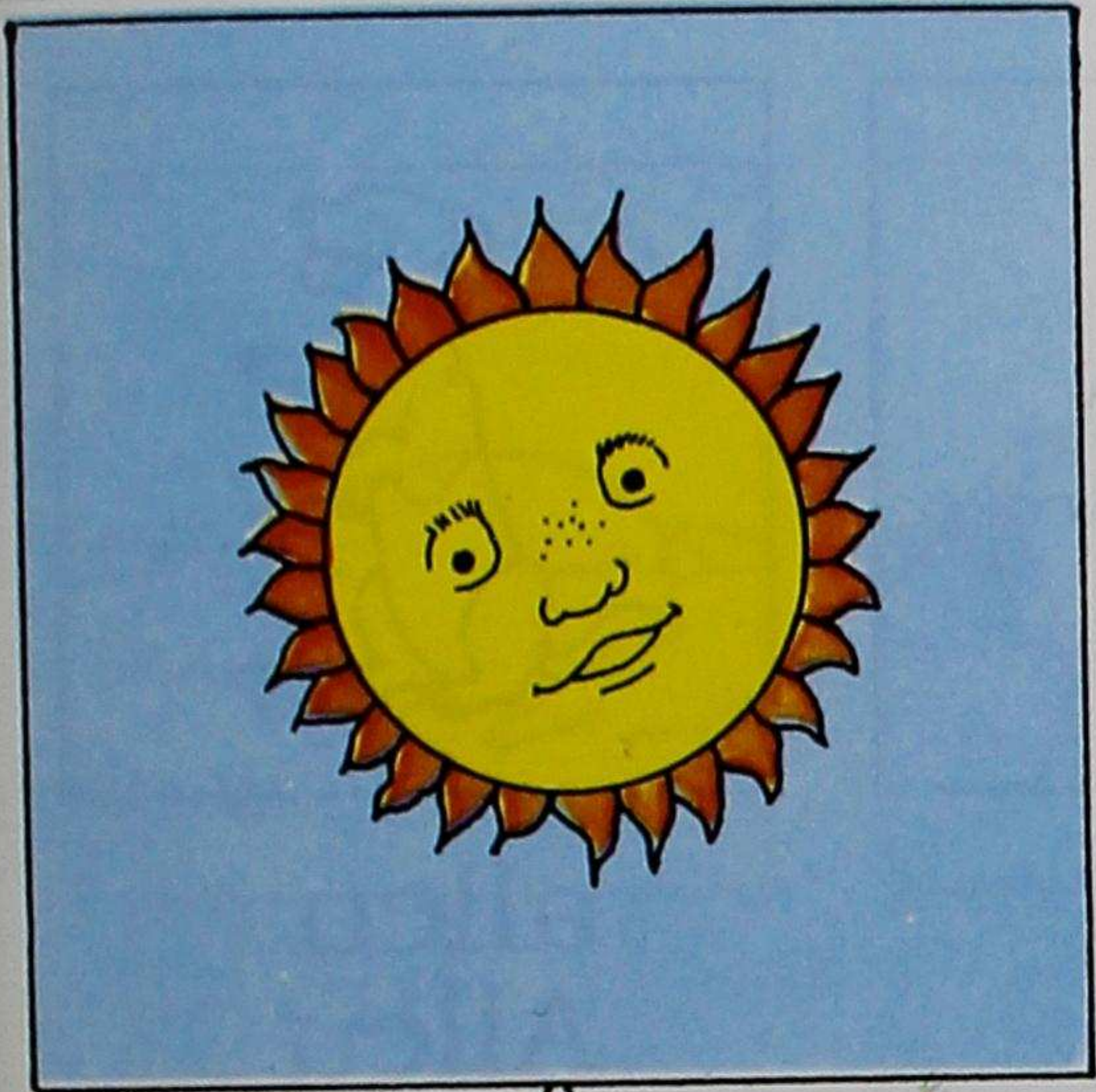

i I

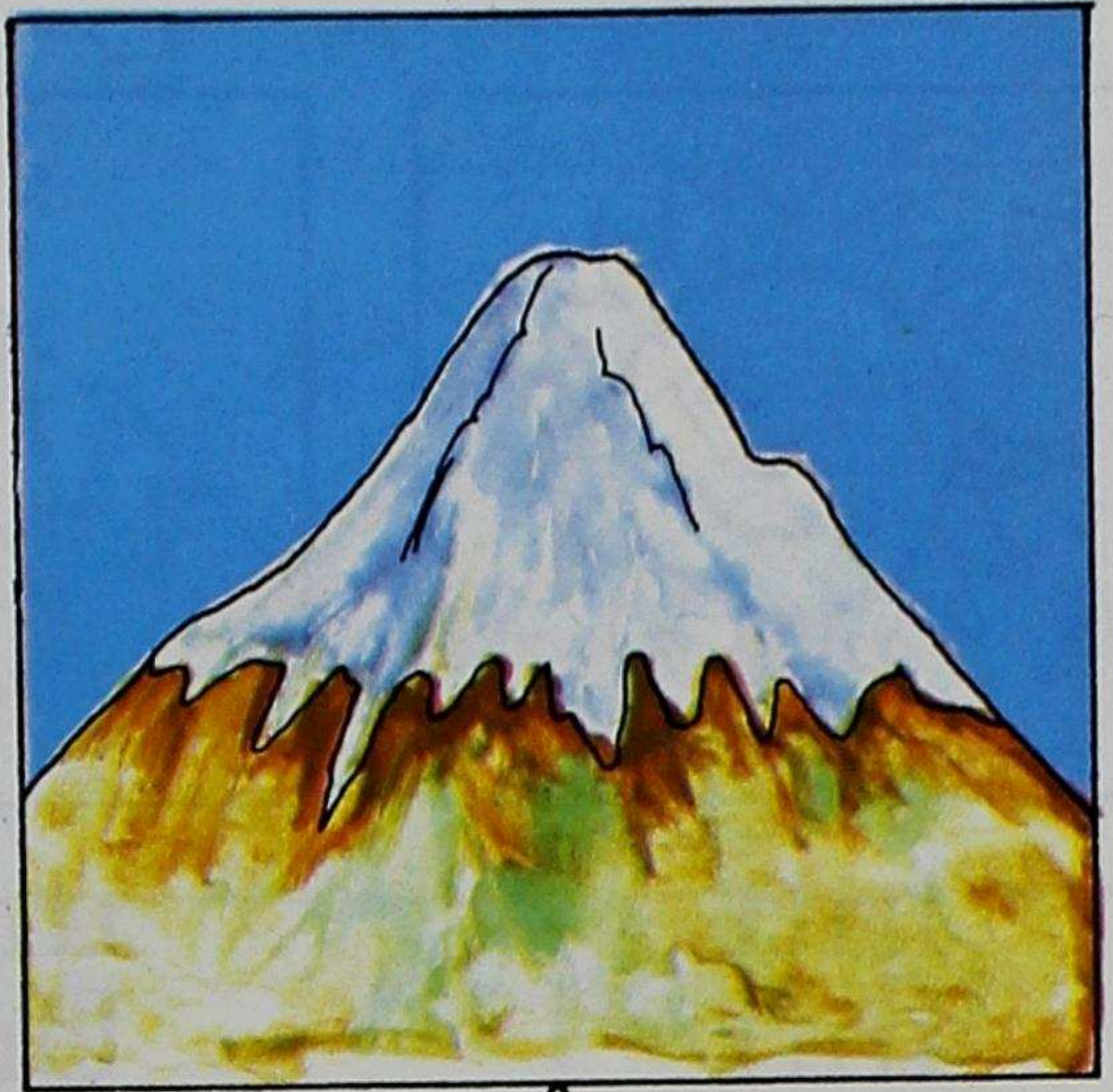

u U

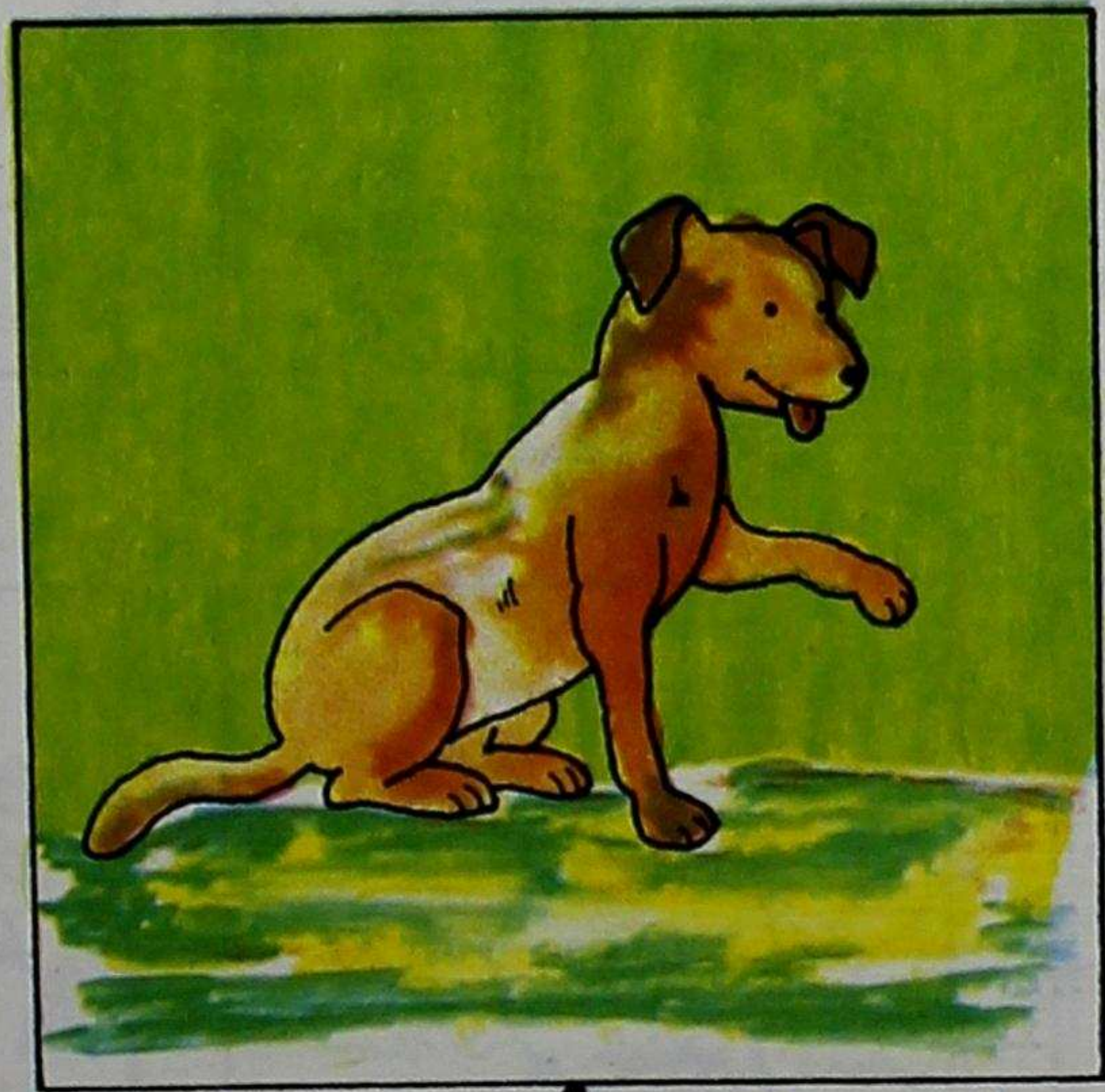

a a A

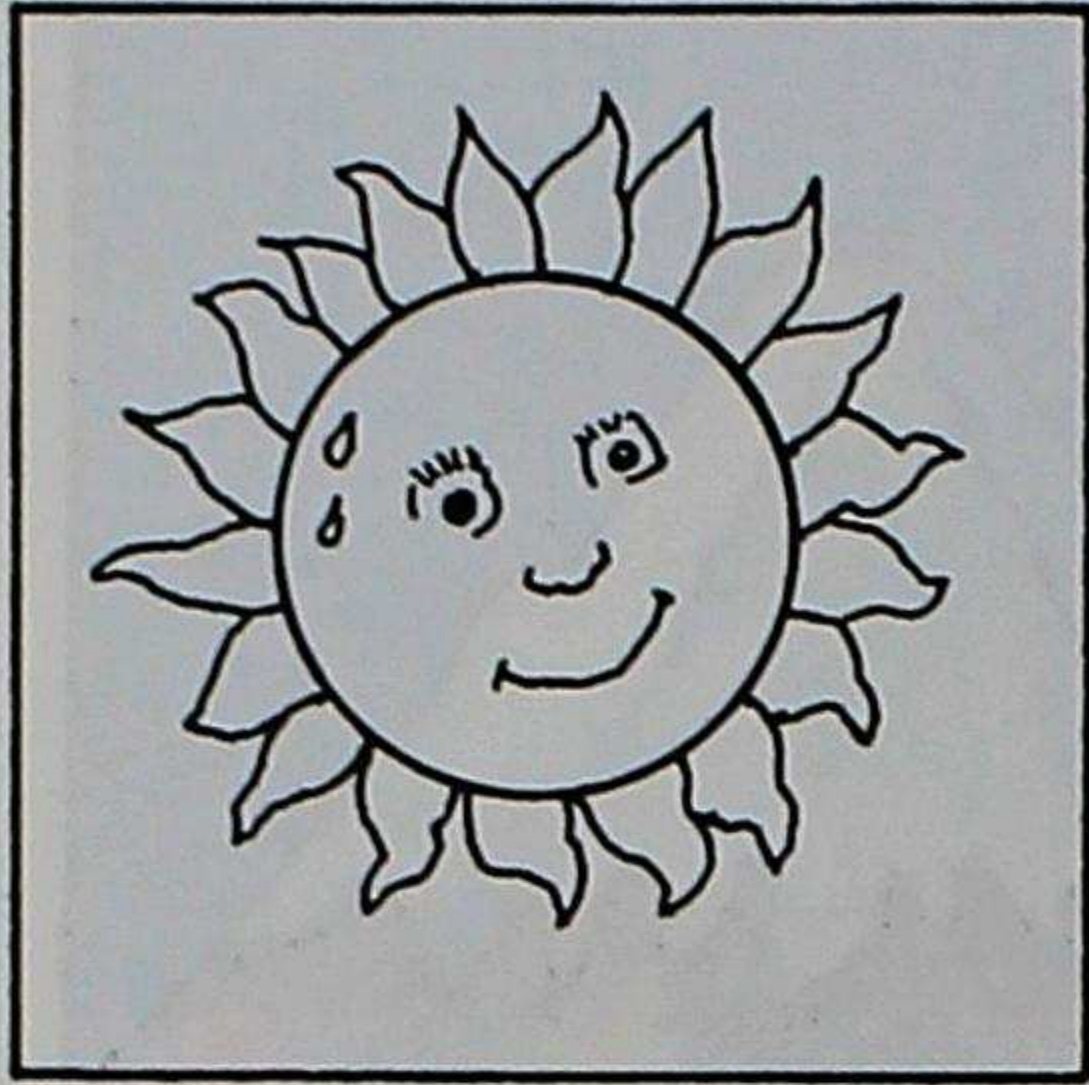
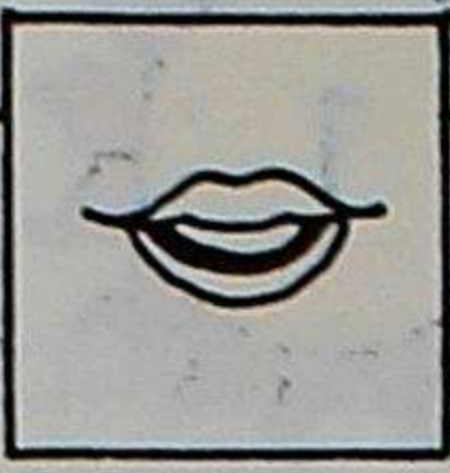

inti  
Inti

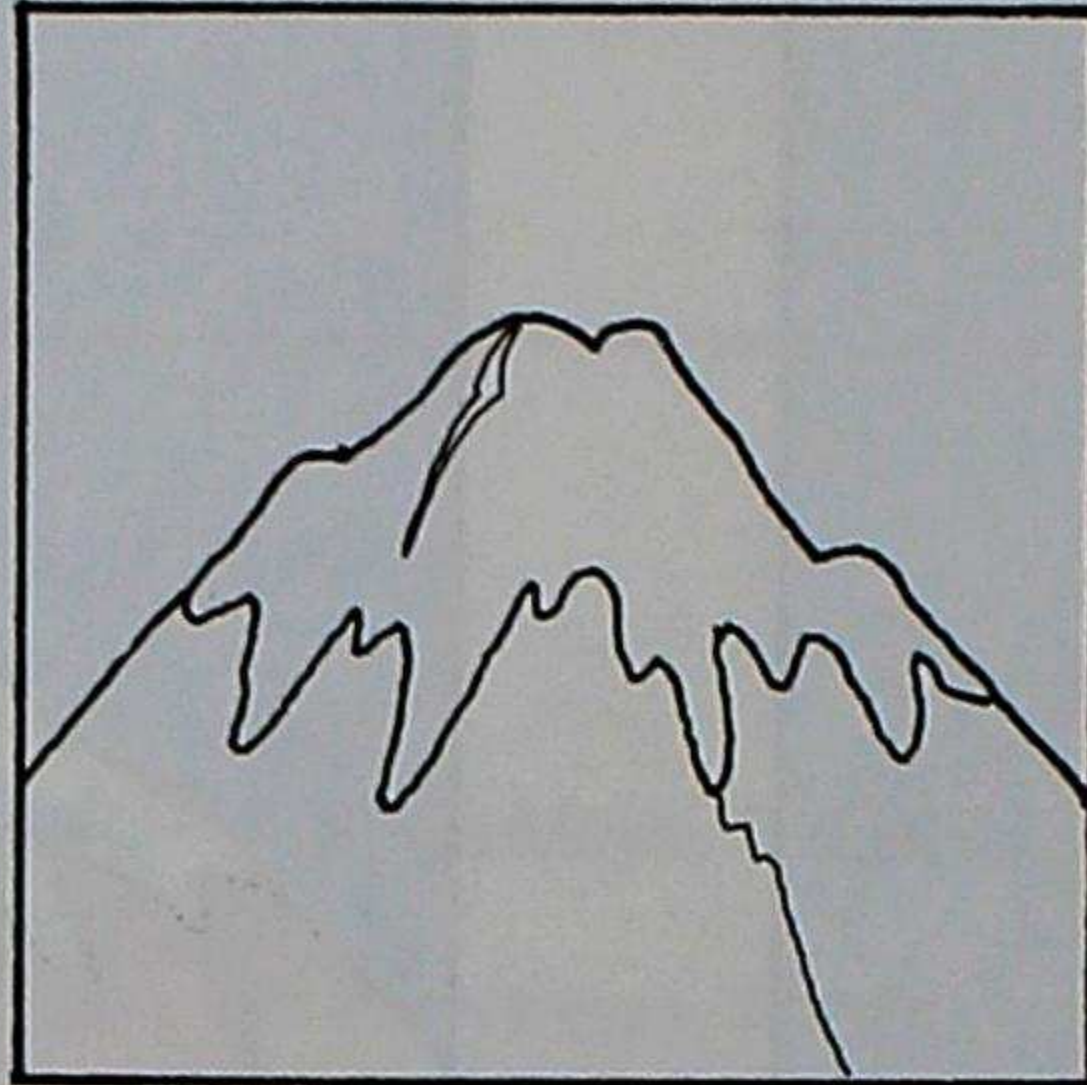

urcu  
Urcu



allcu  
Allcu



ucucha

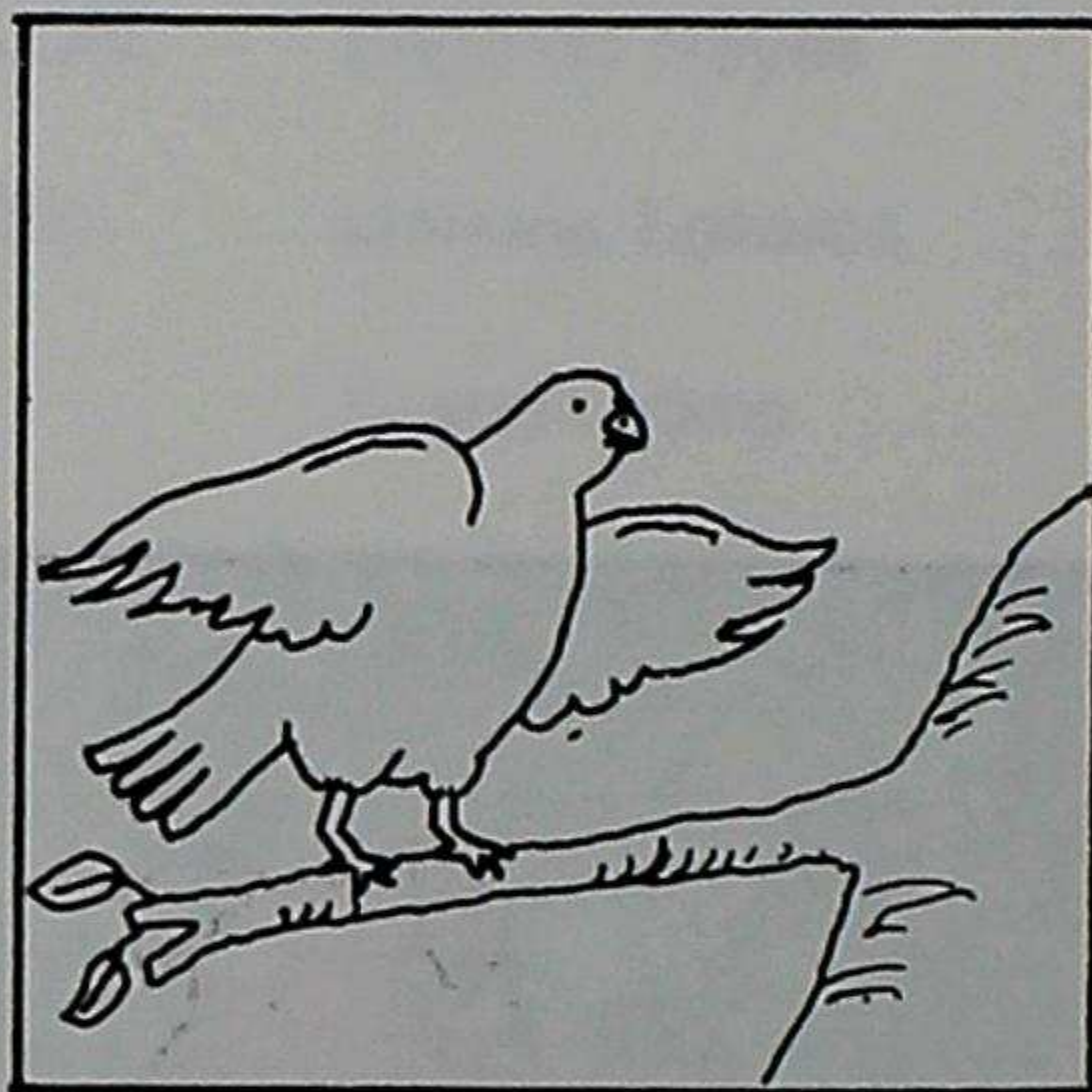

urpi

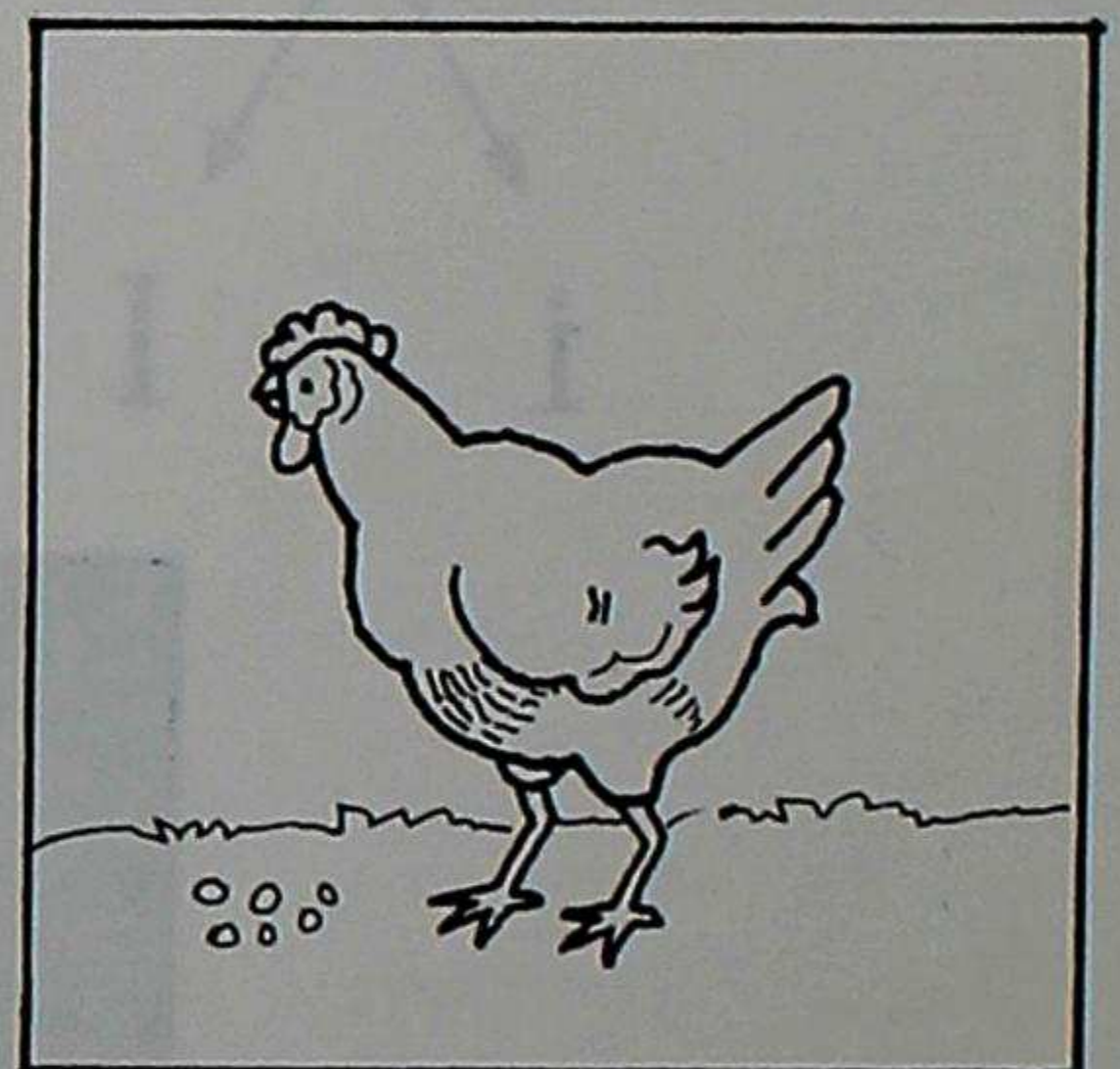

atallpa

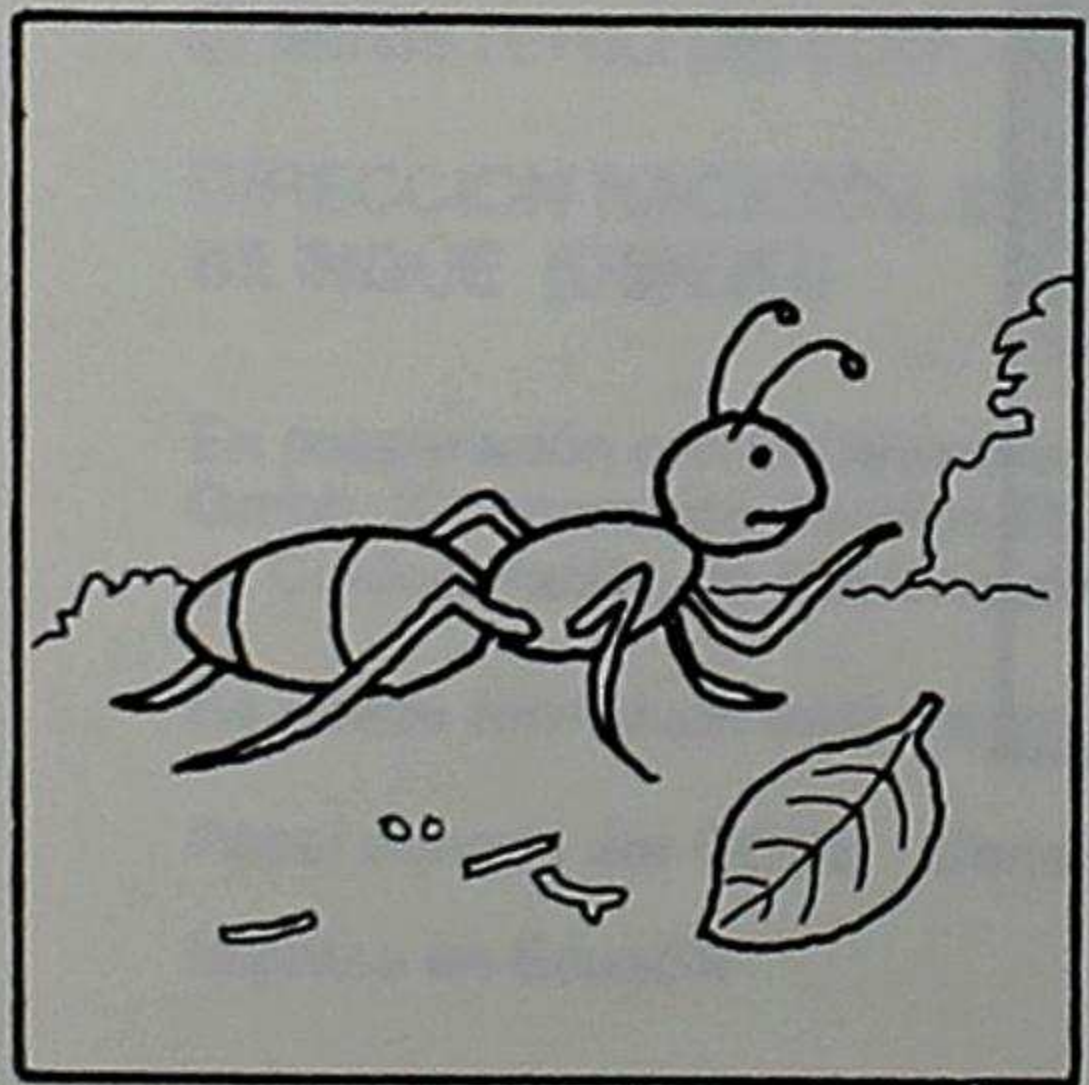

añancu

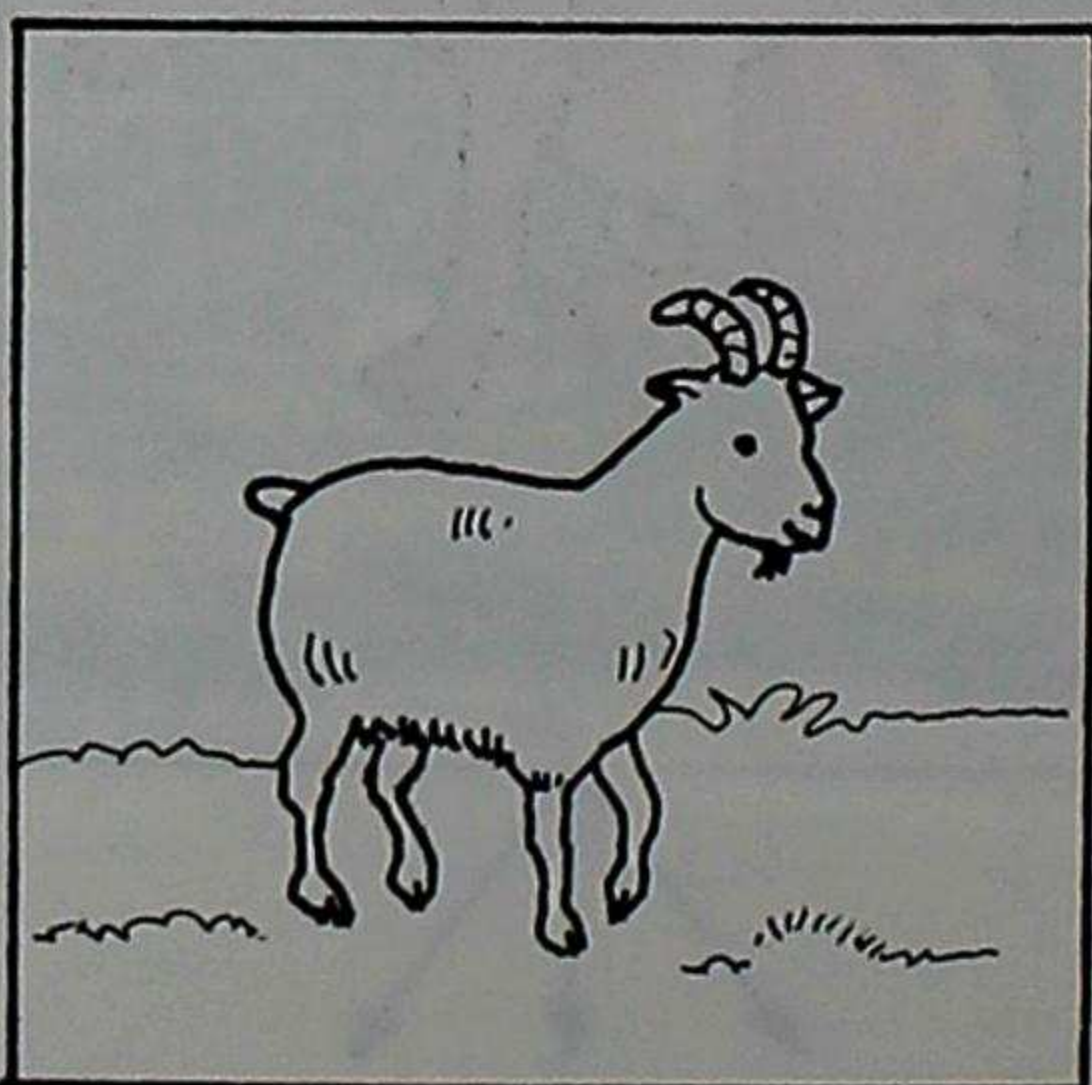

incu

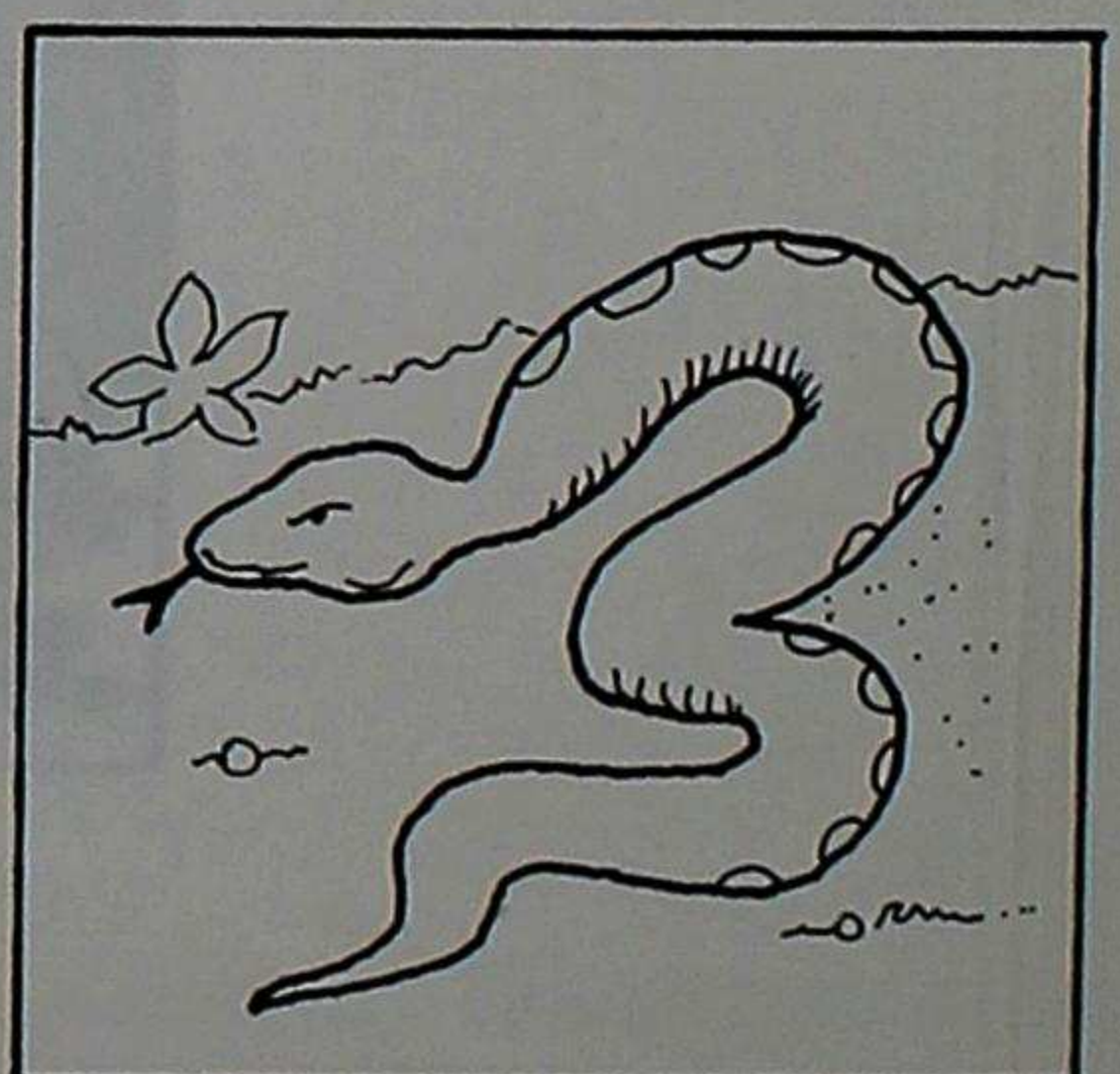

amaru

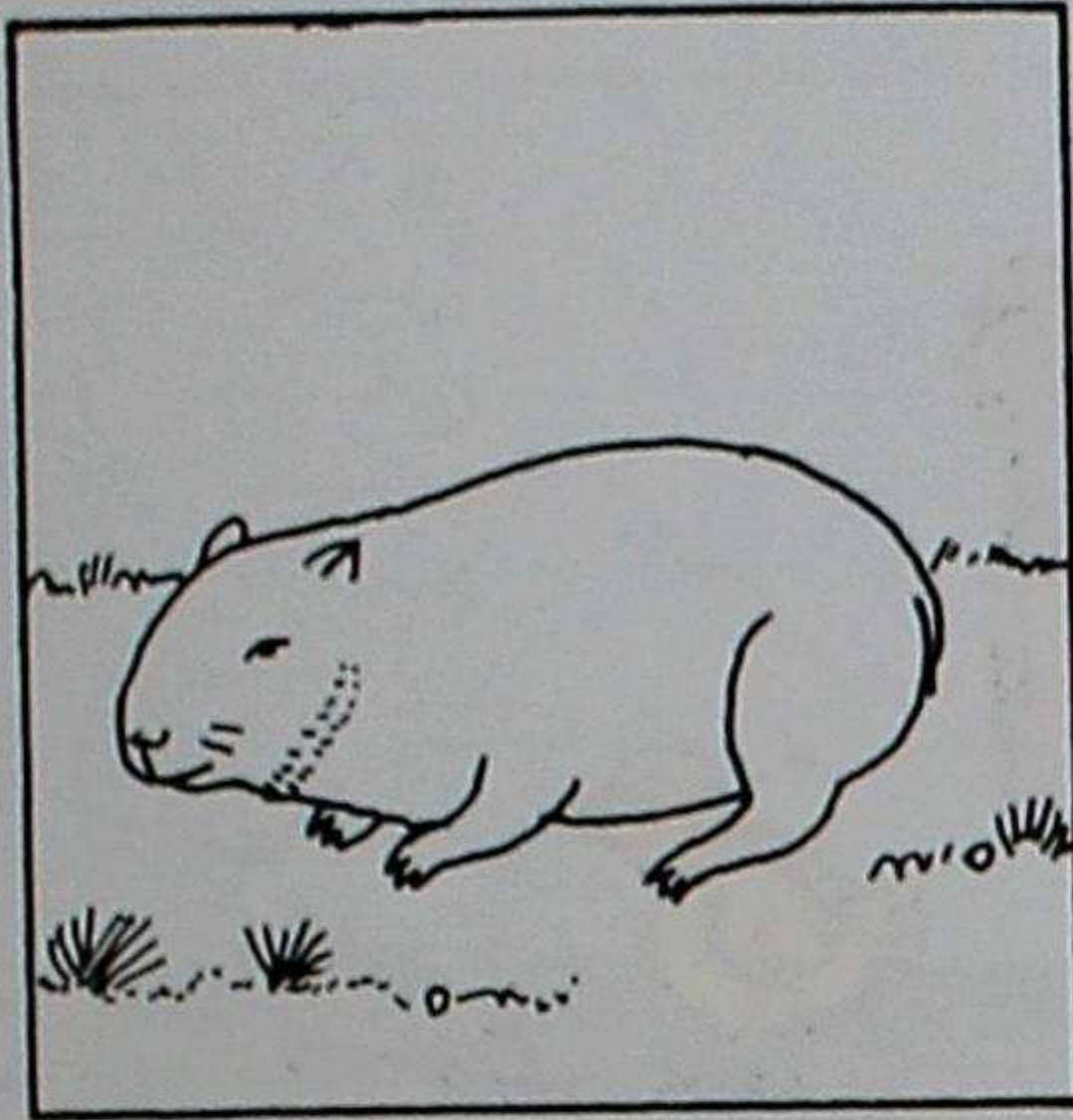
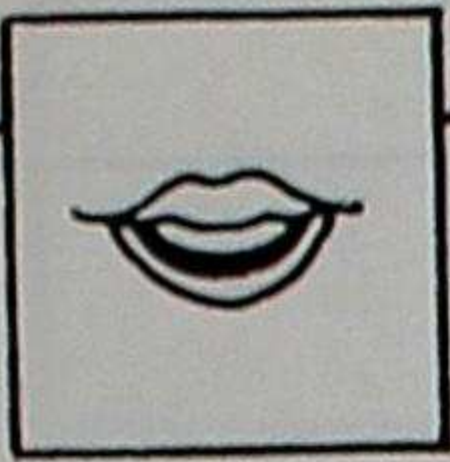

cui

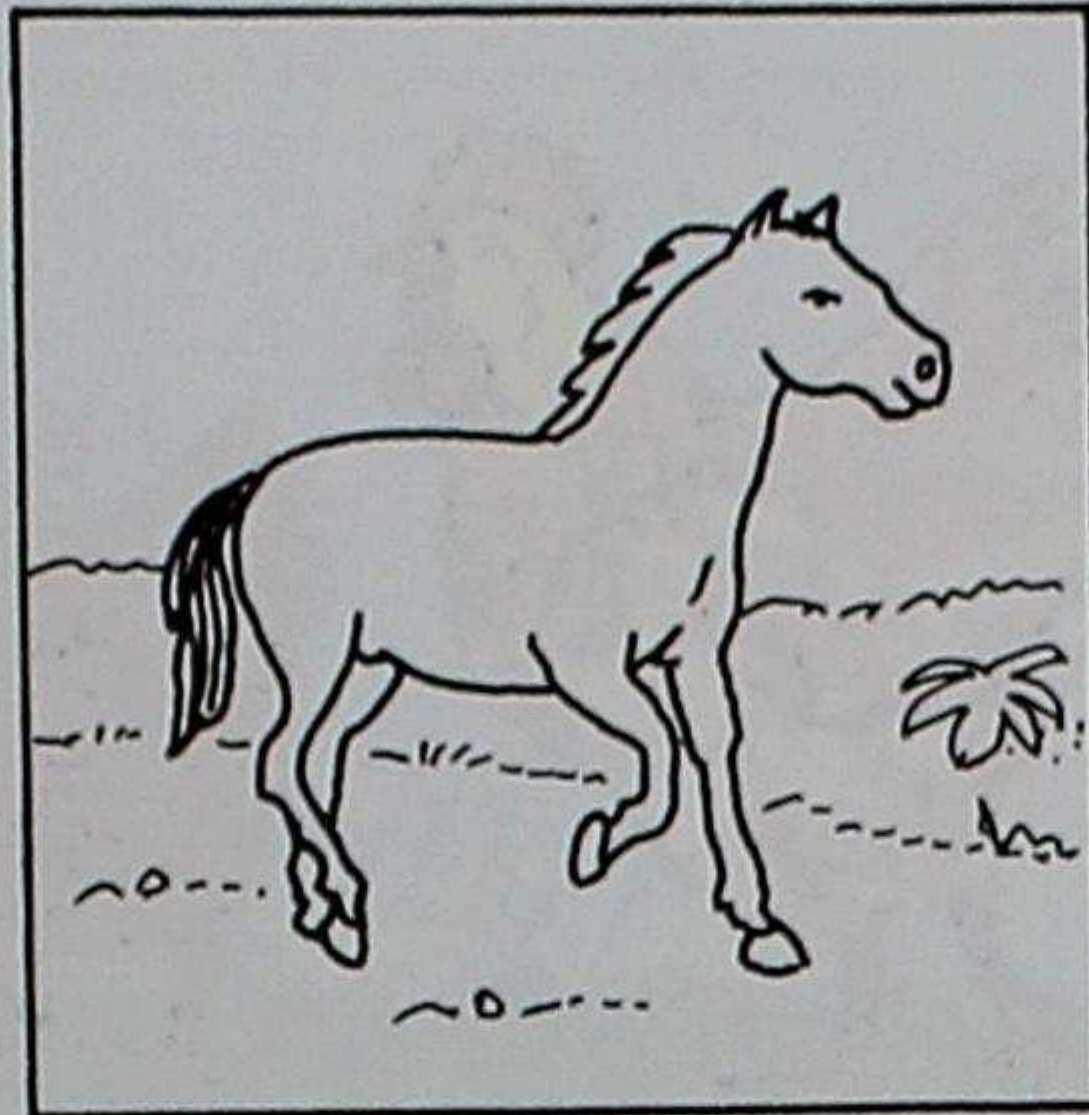

apiu

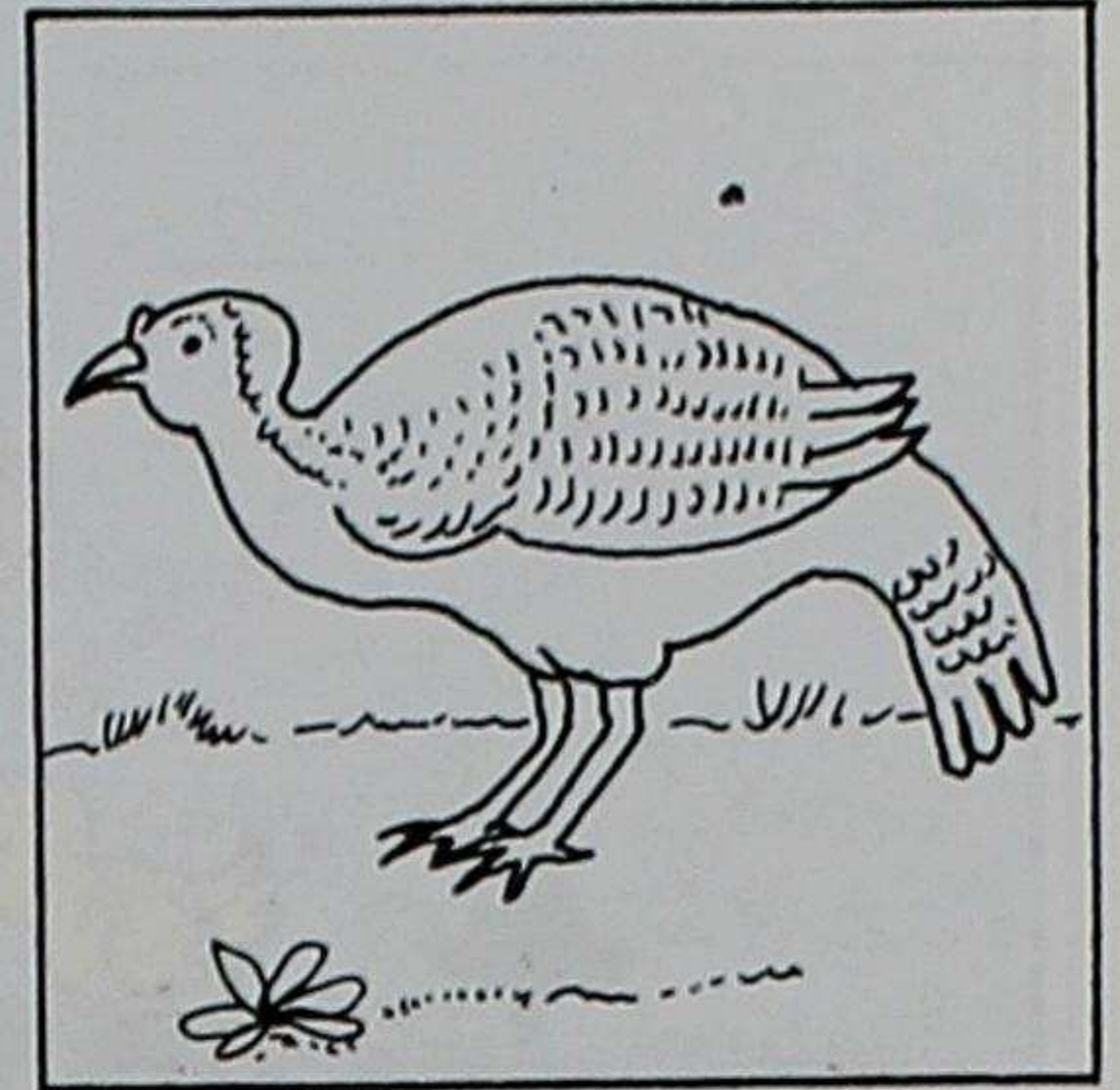

paushi

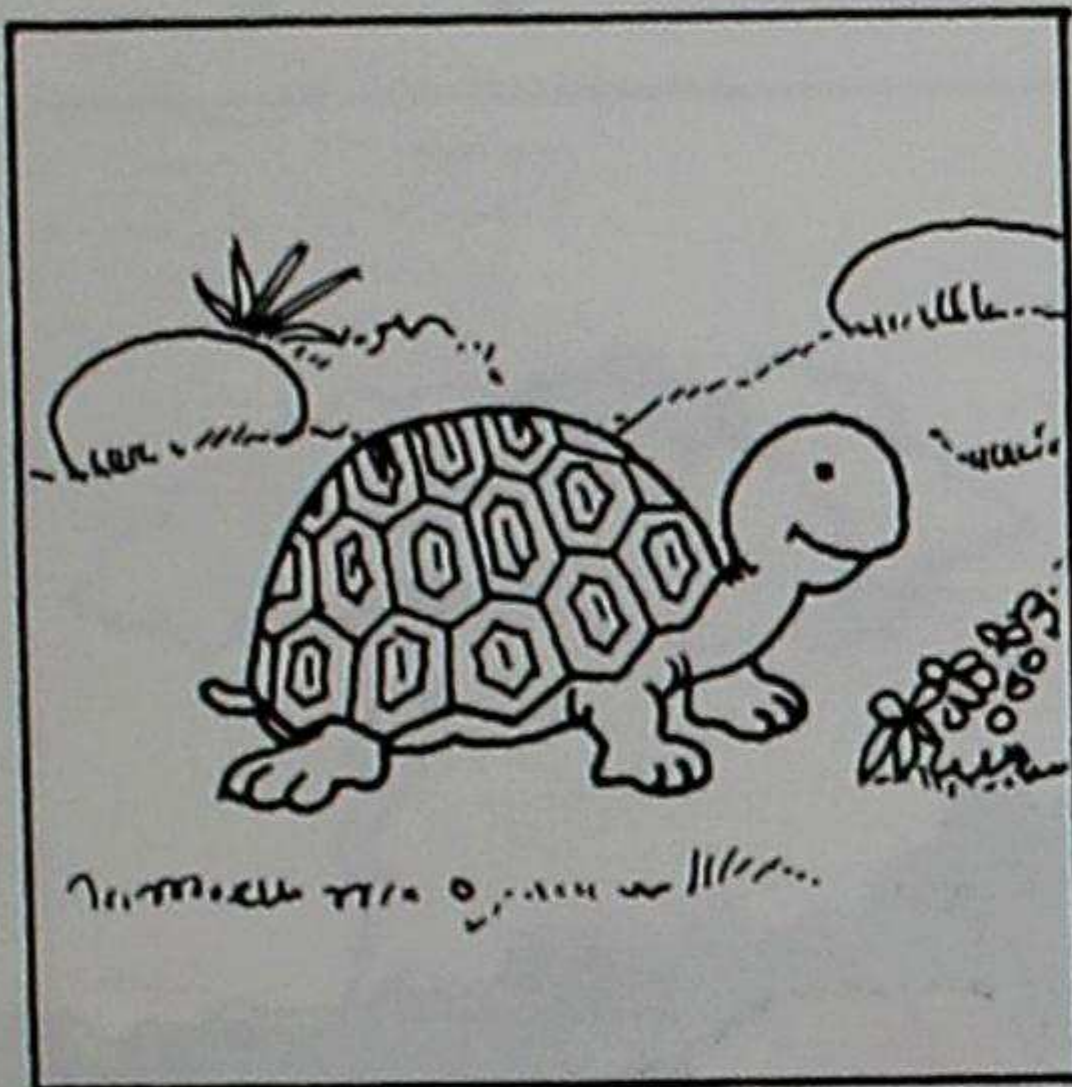

yahuati

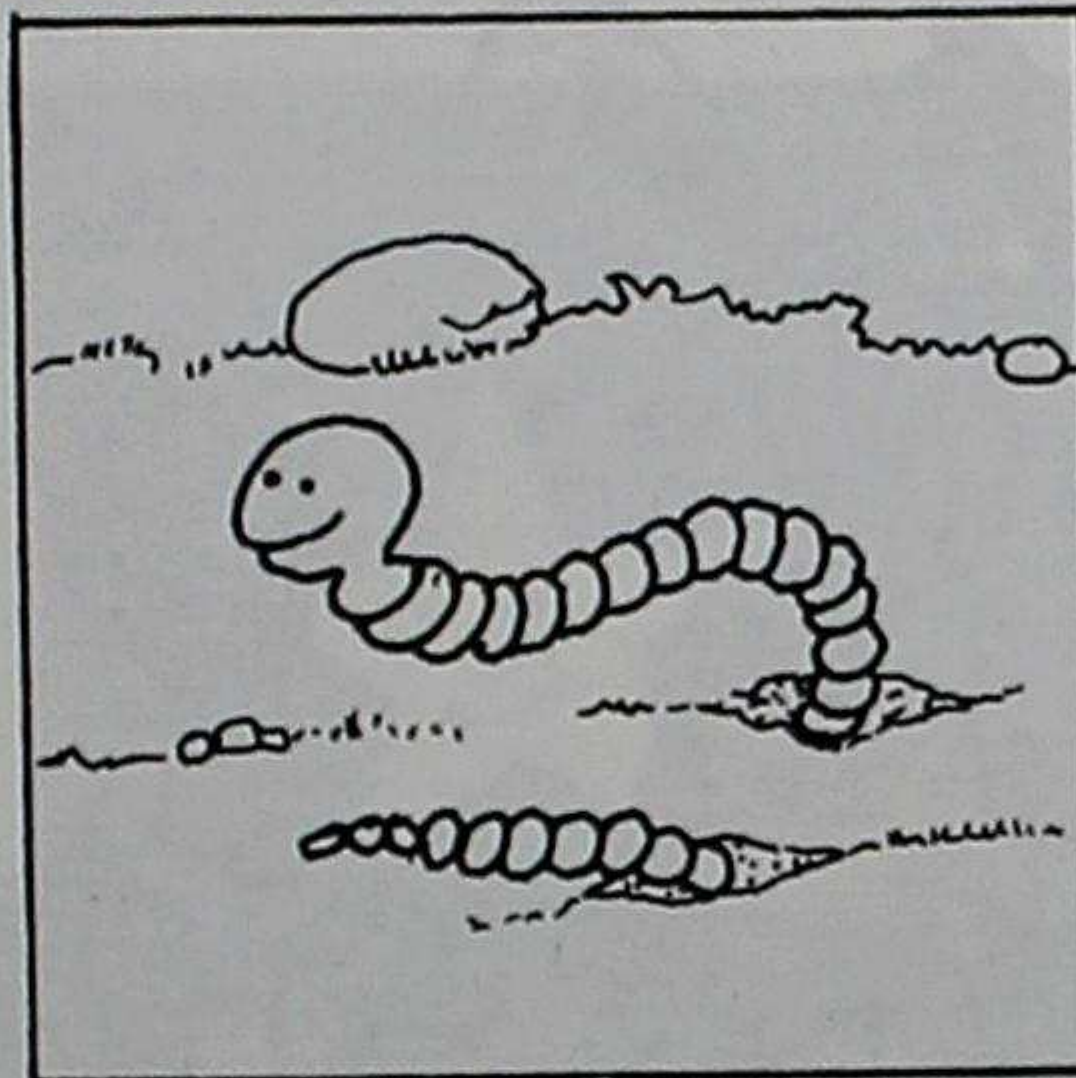

cuica

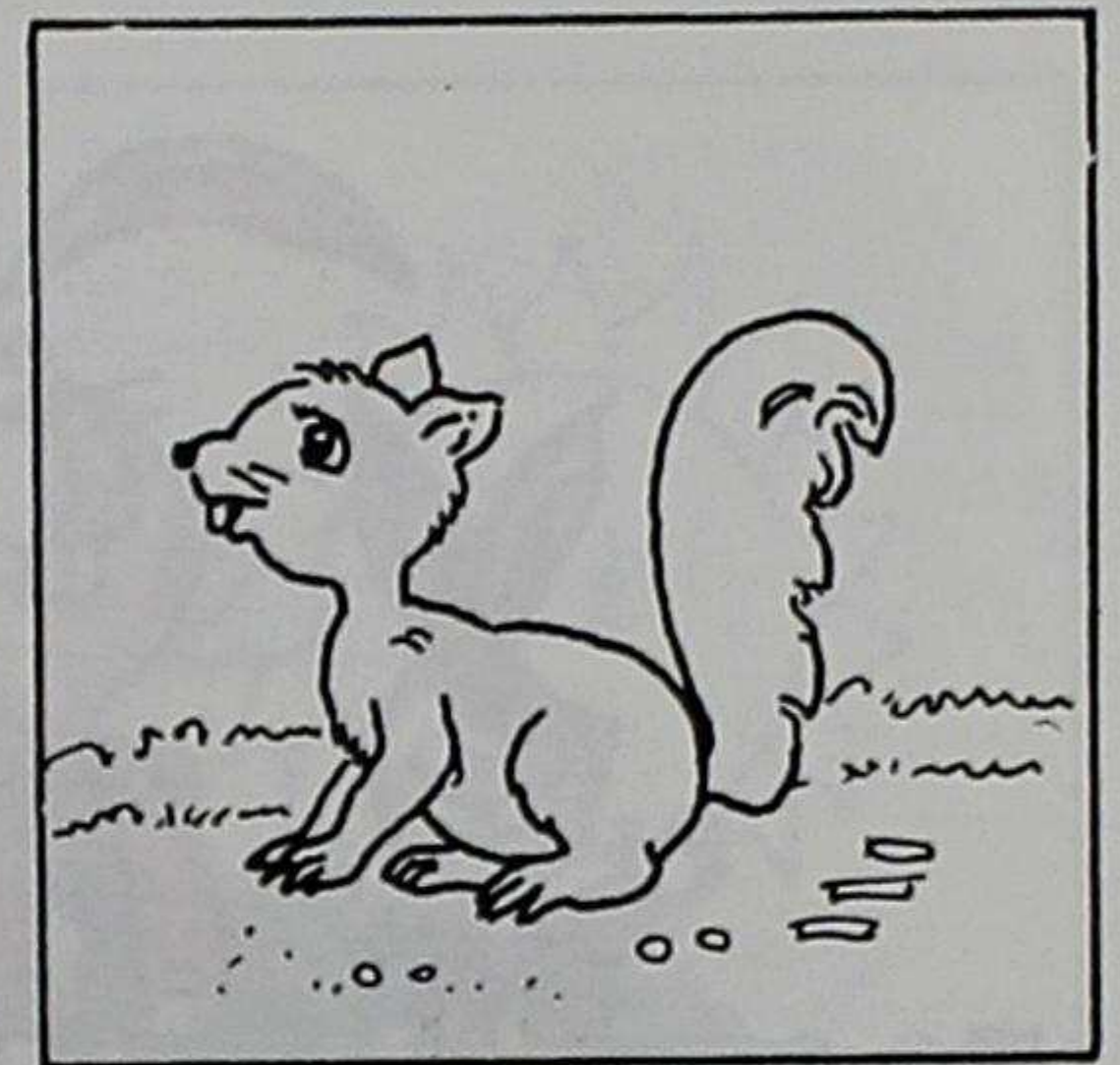

huaihuashi

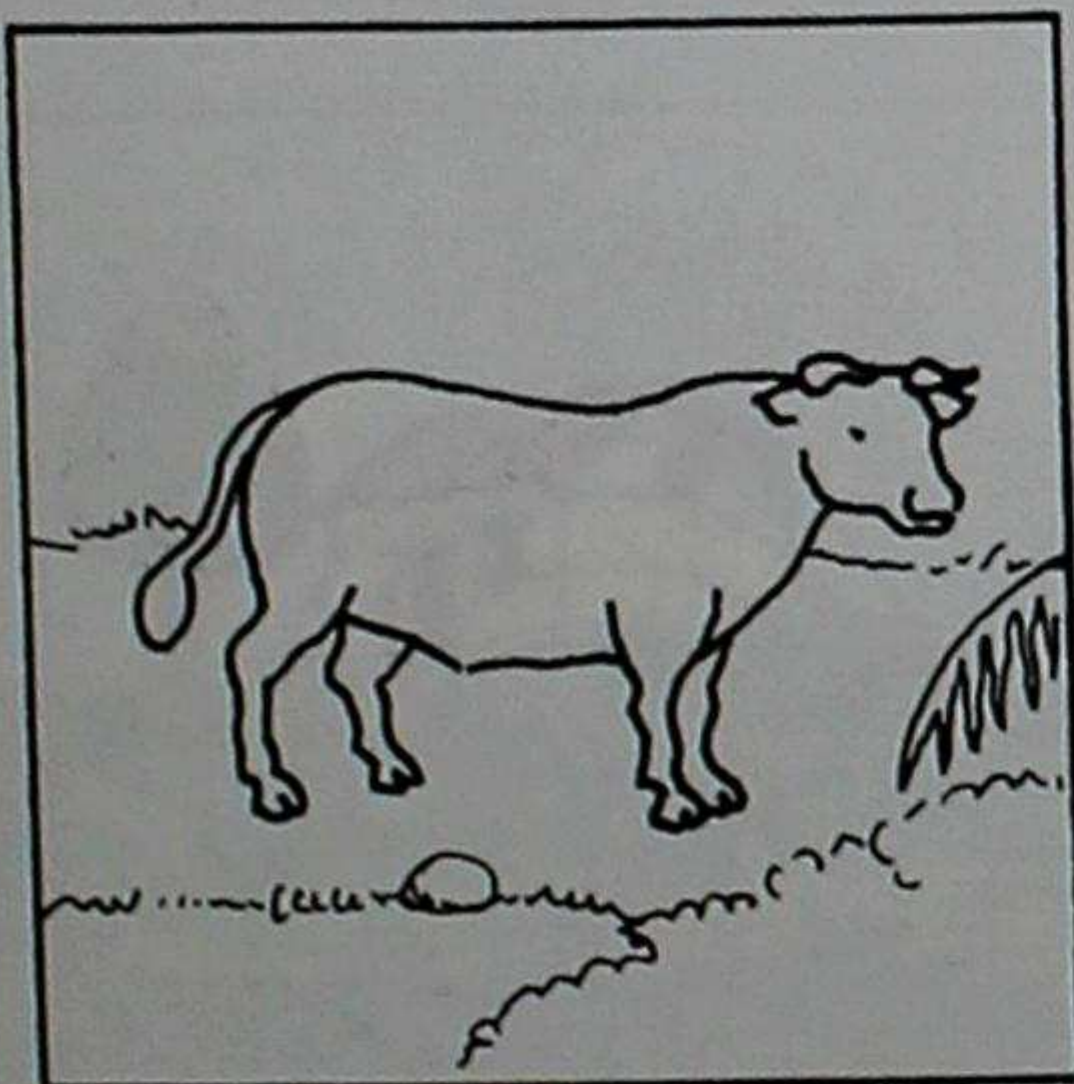

huacra

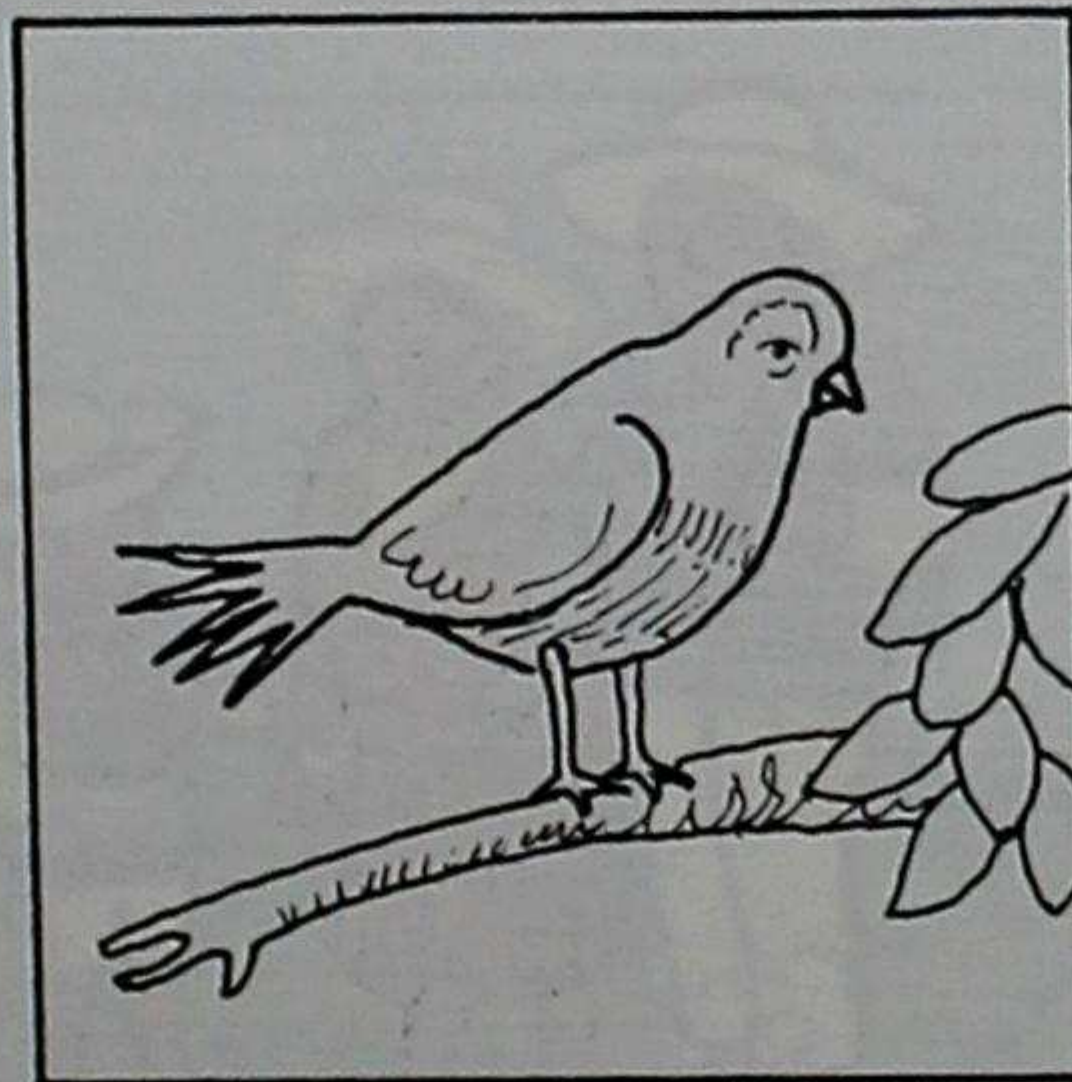

huiracchuru

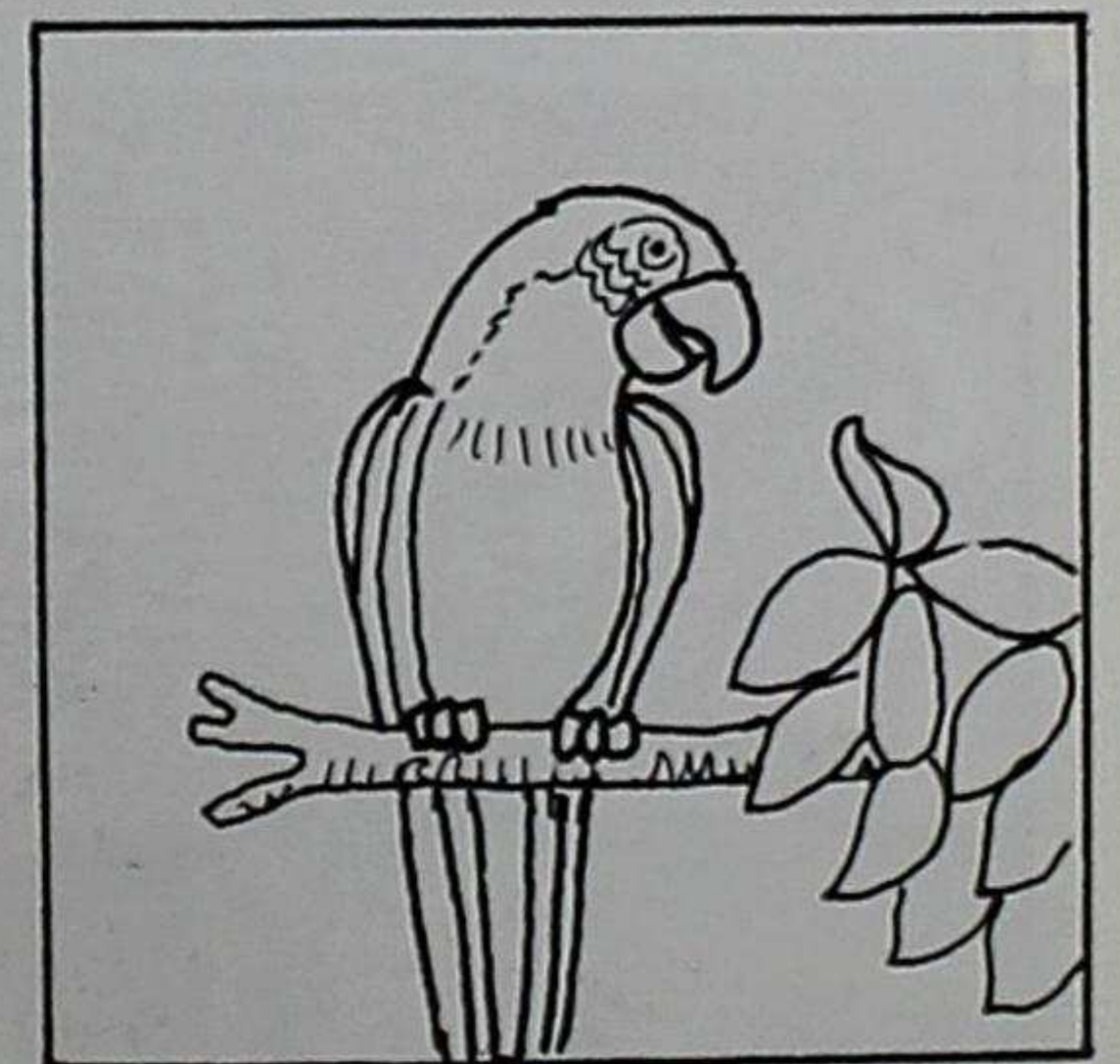

huacamayu

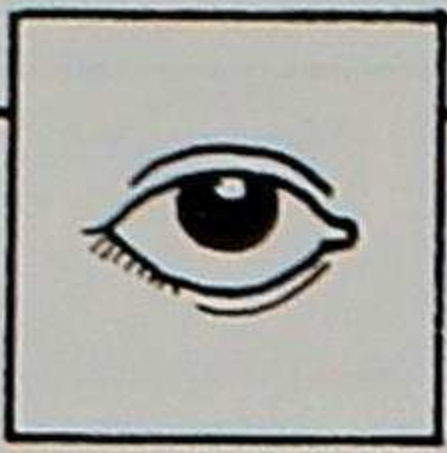

ailu

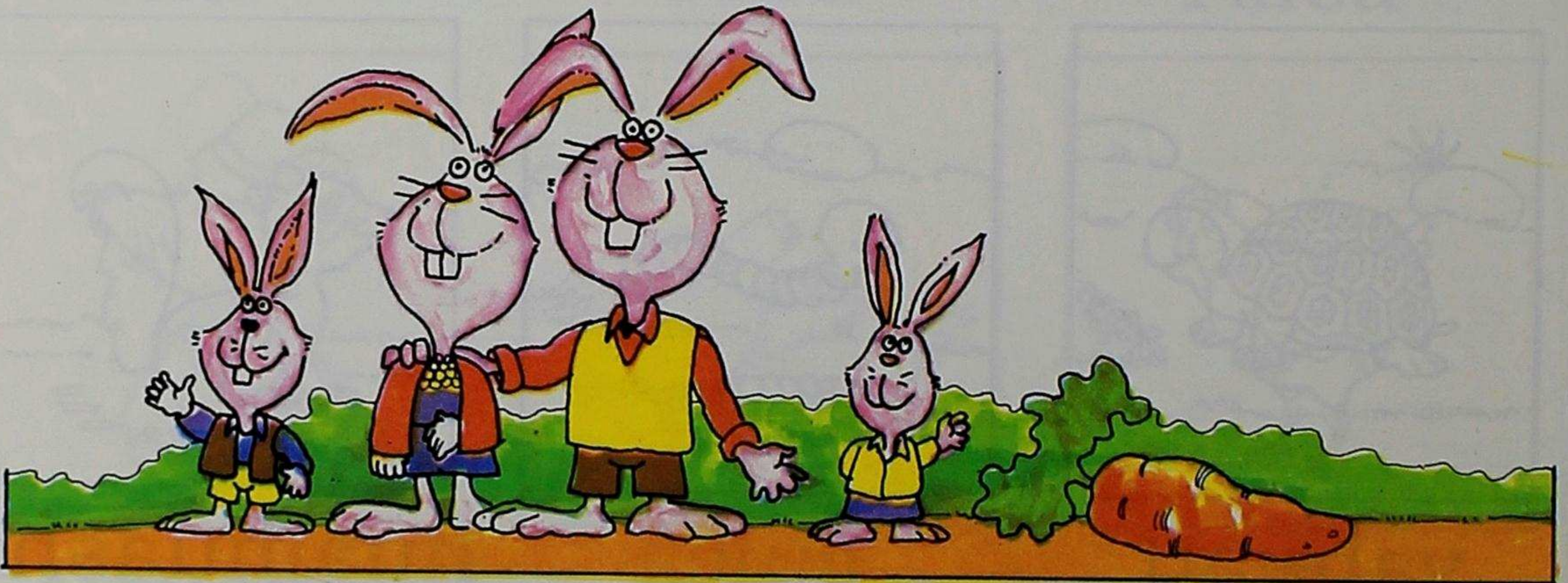
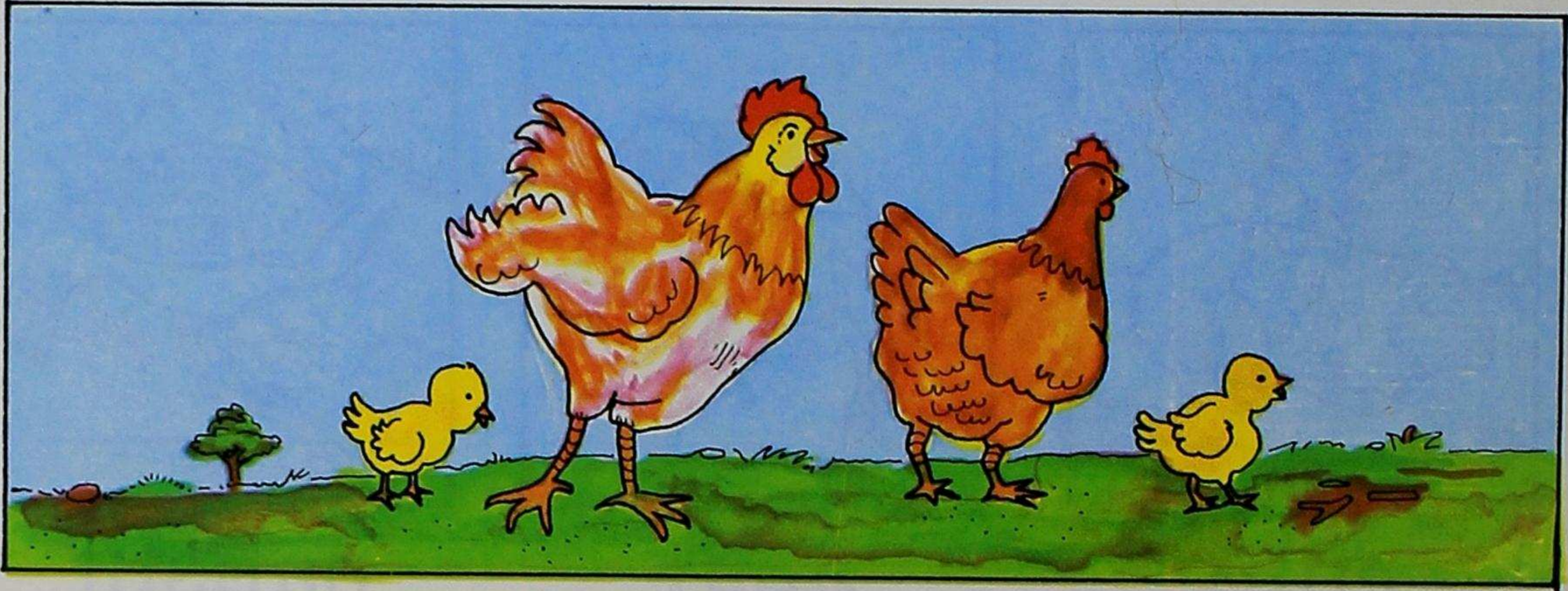

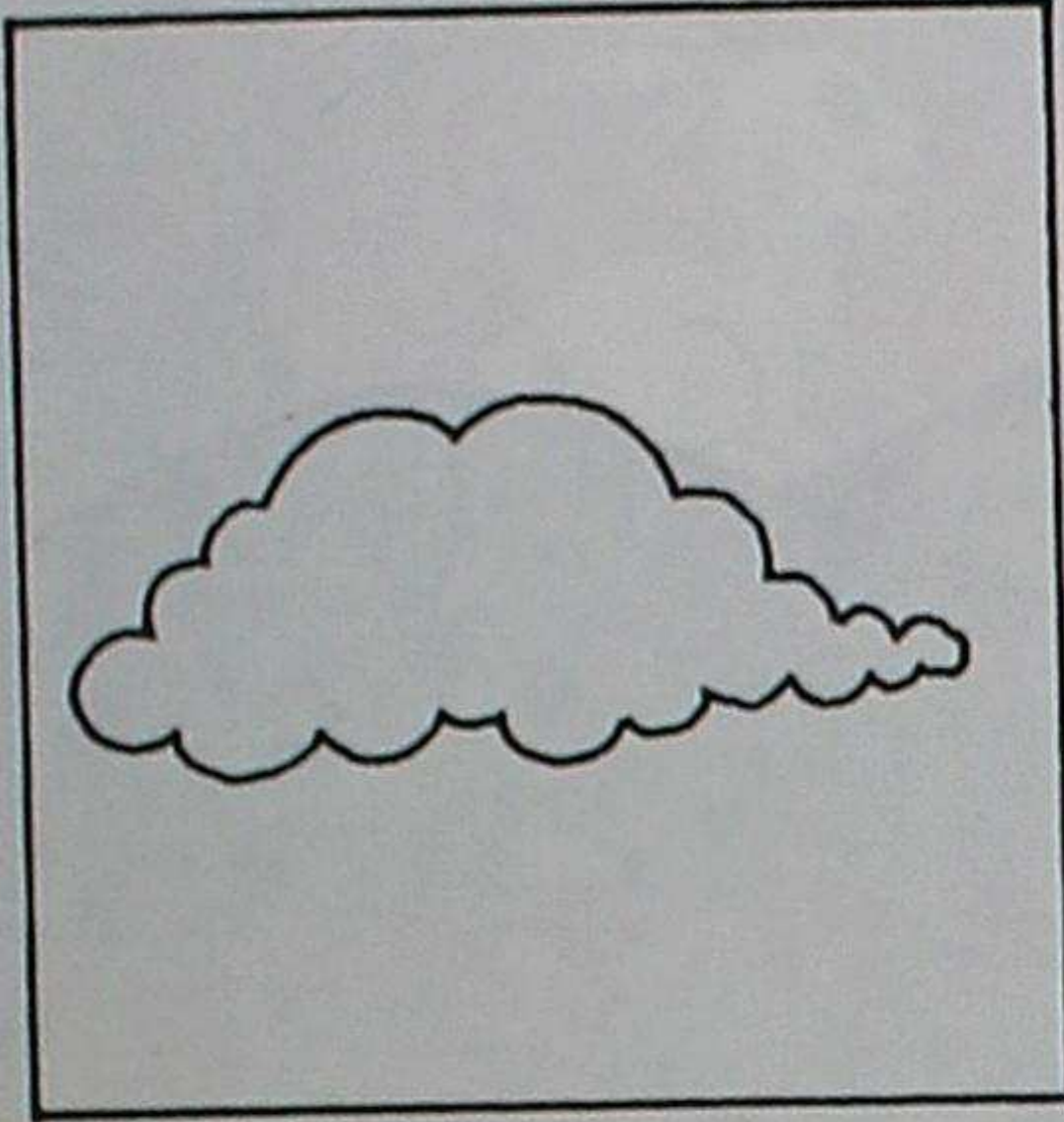
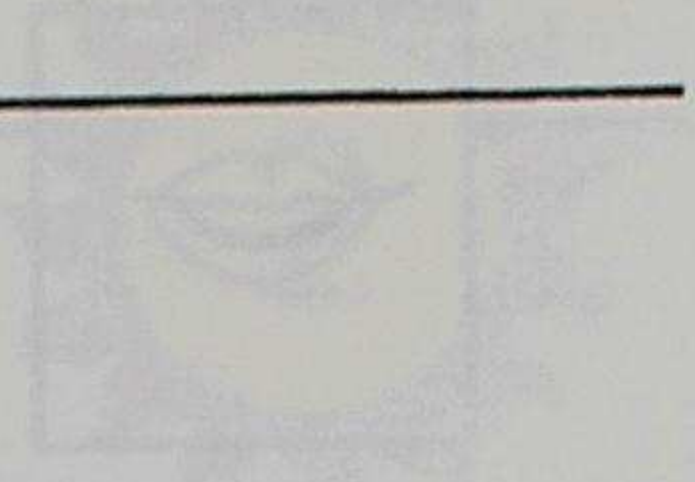
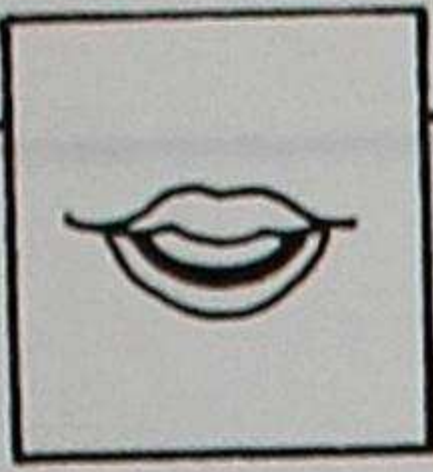

puyu



tamia

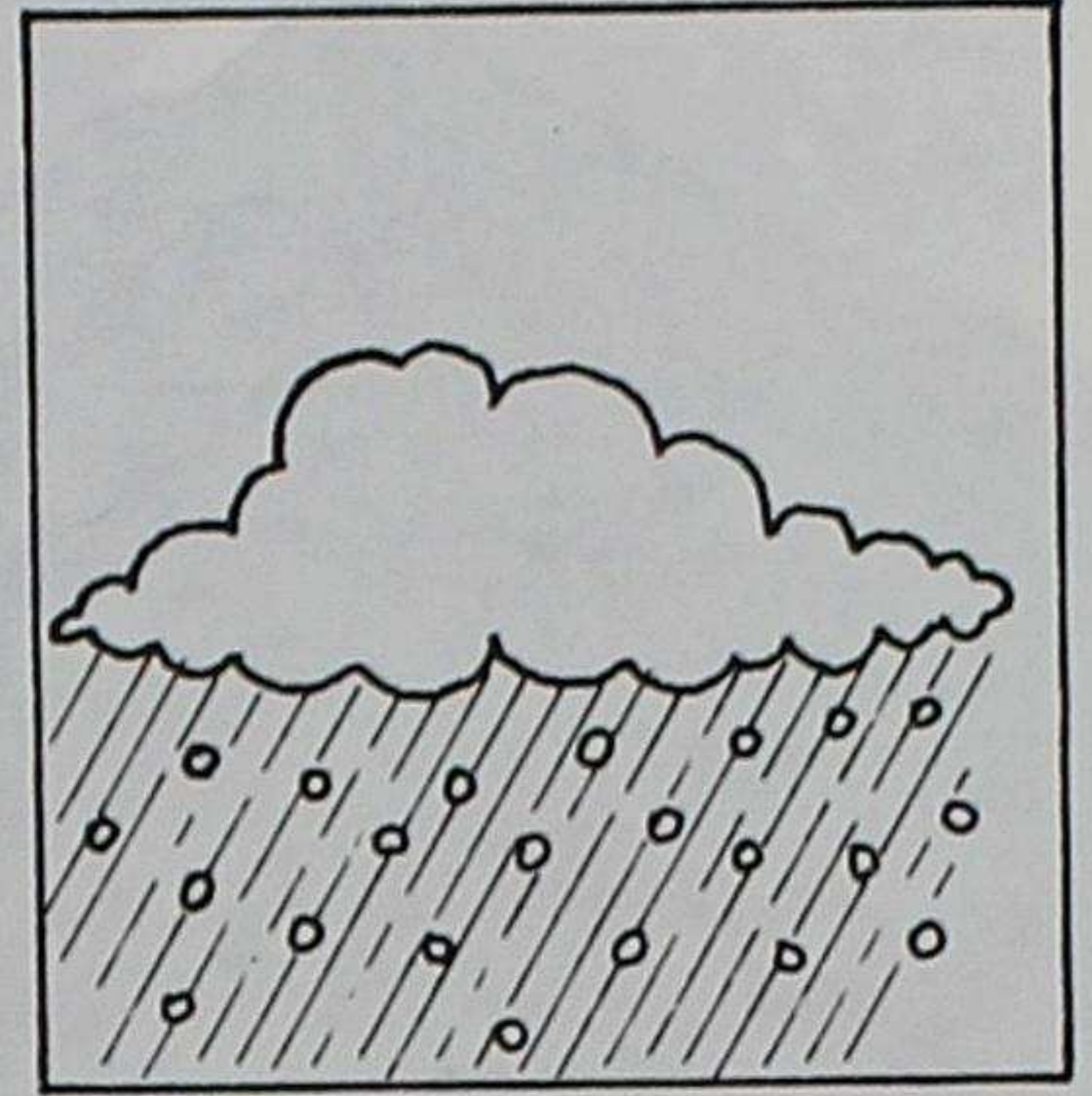

runtu

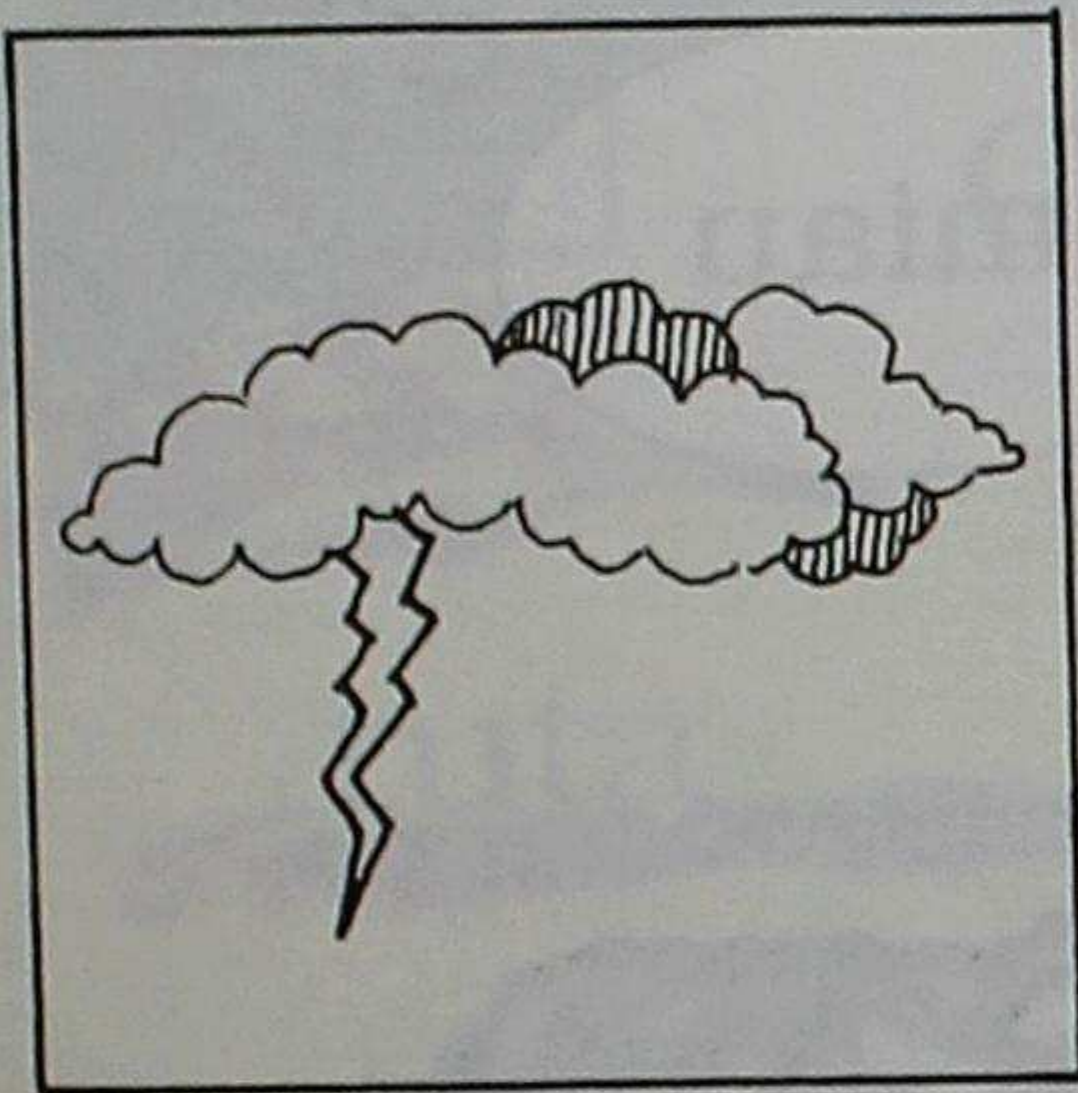

illapa

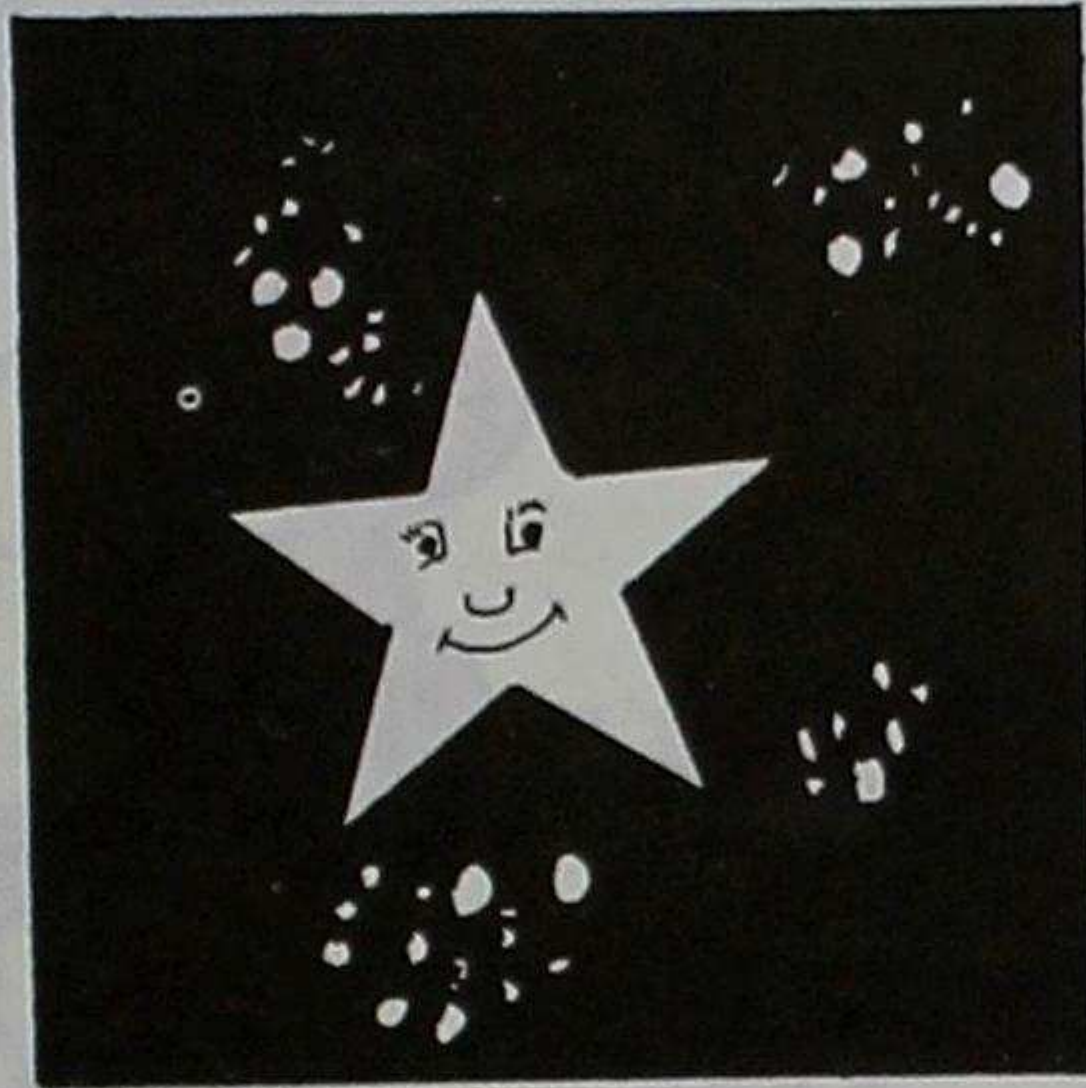

cuillur

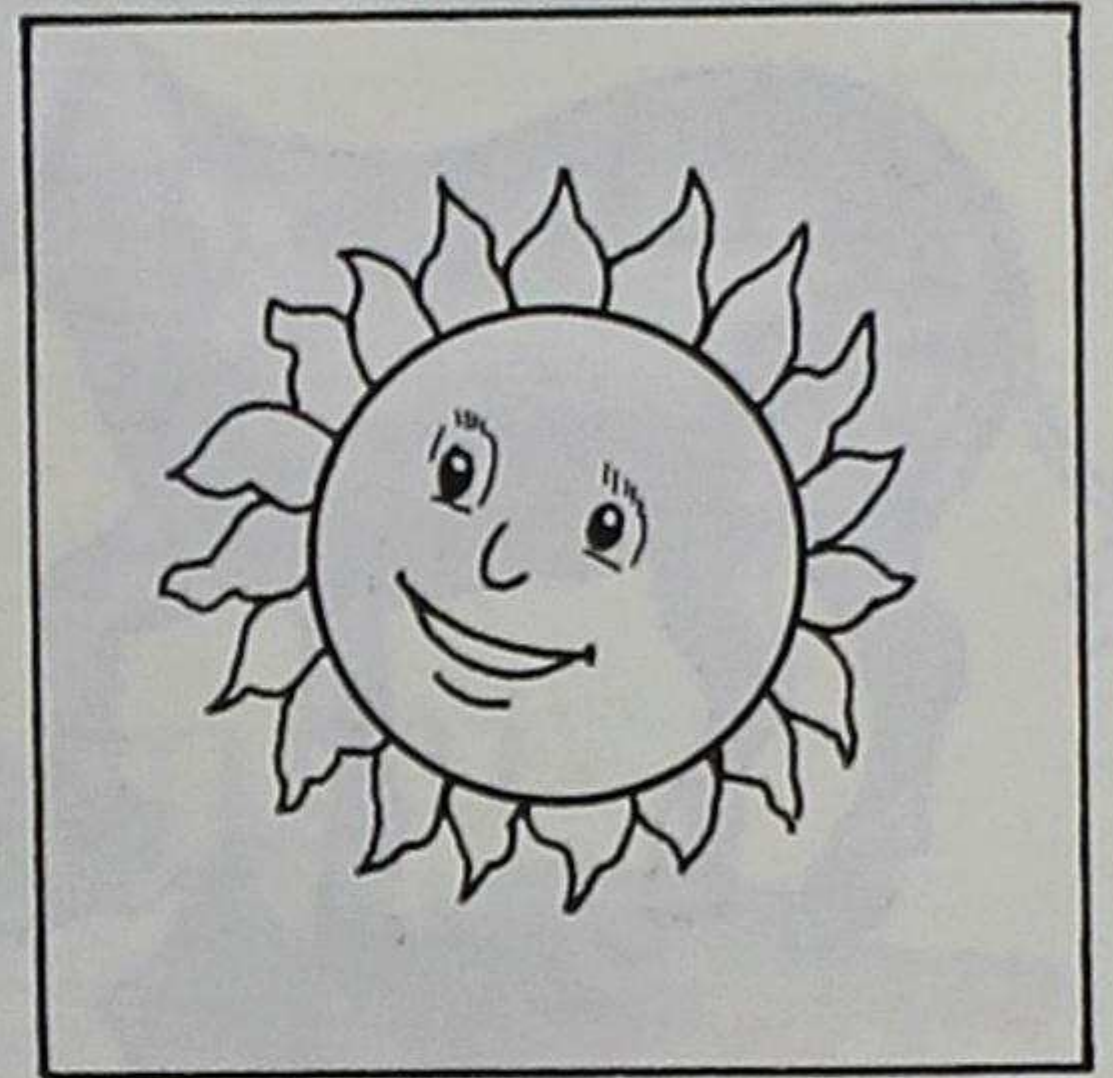

inti

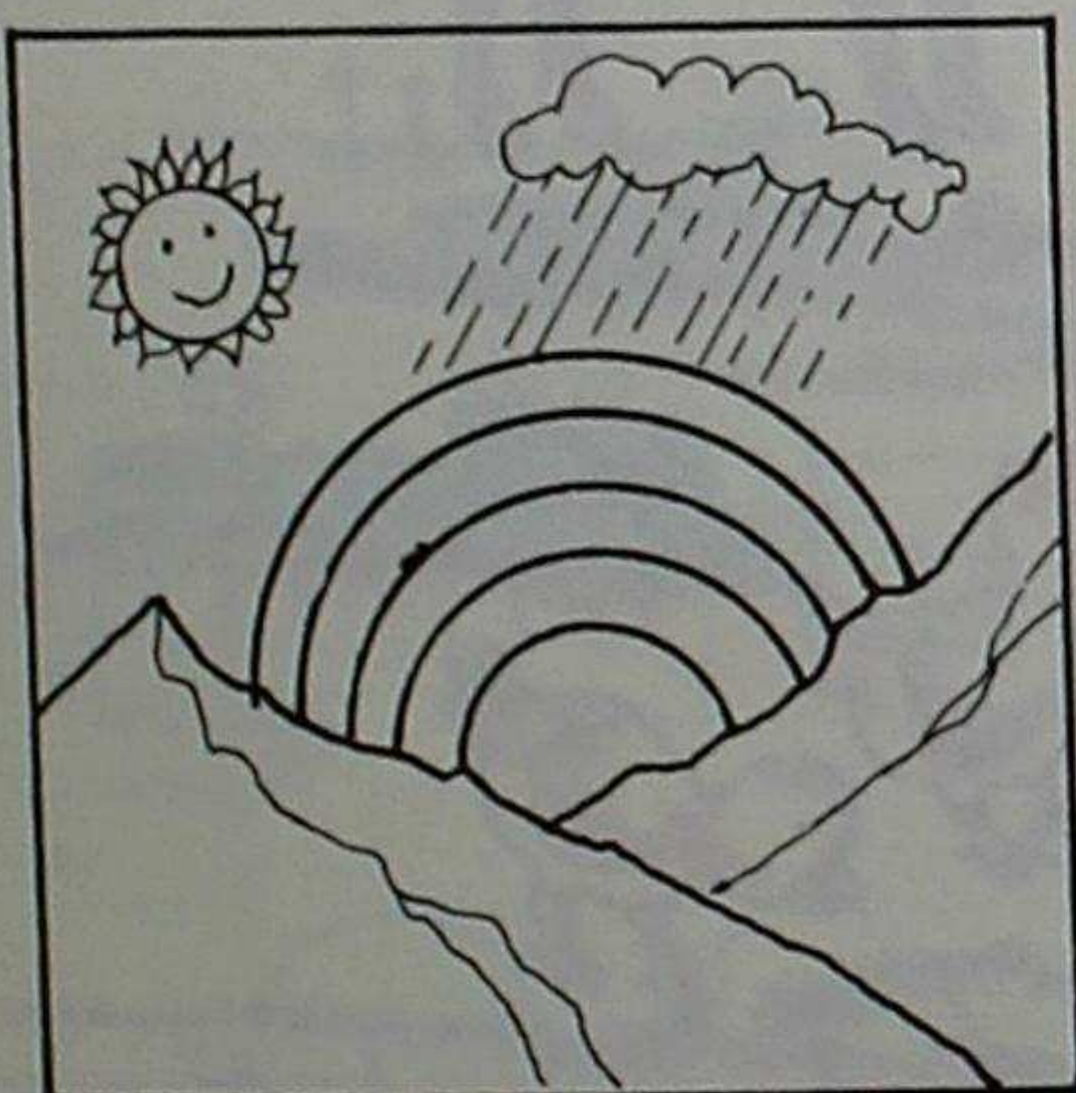

cuichi

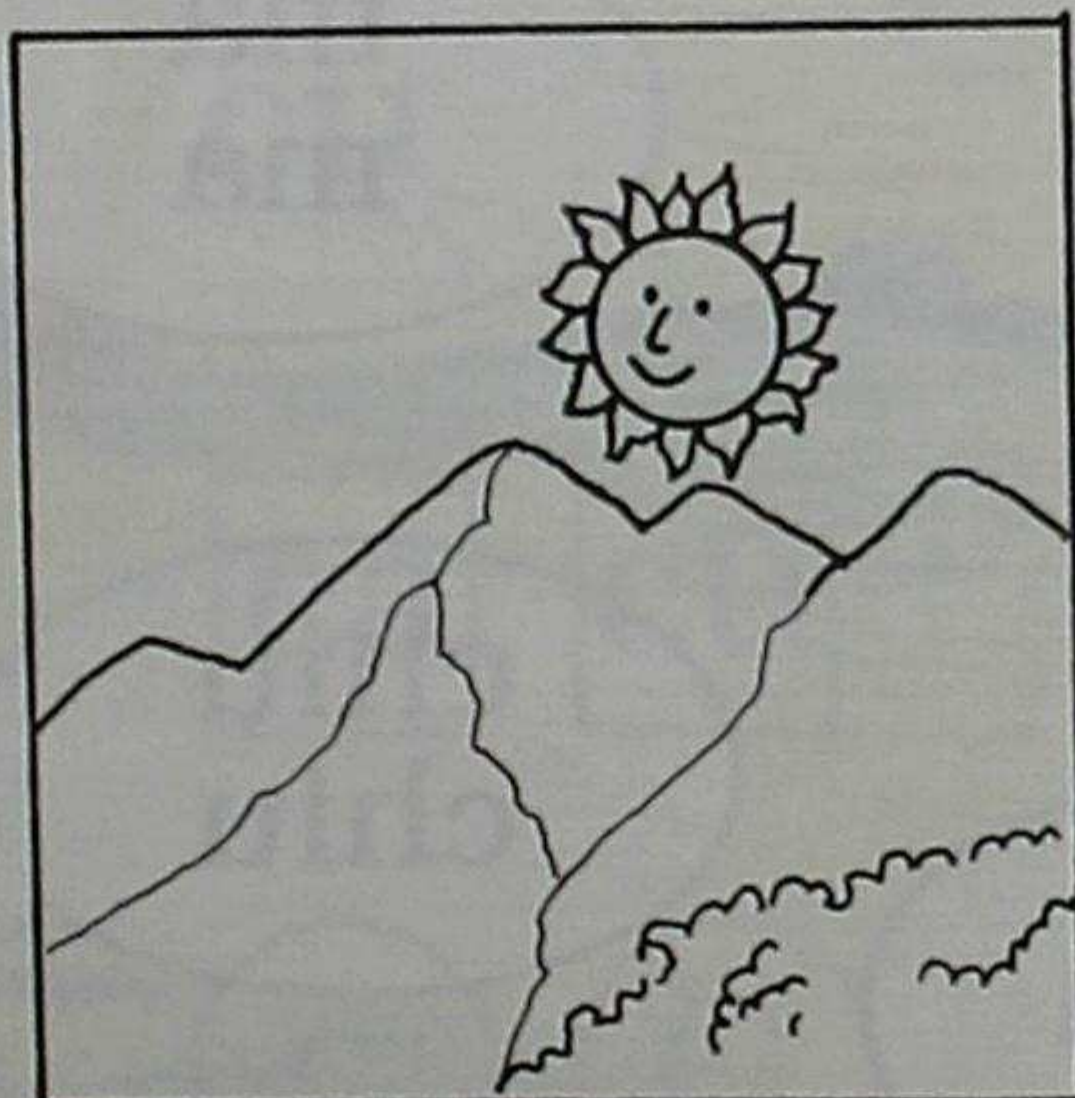

puncha

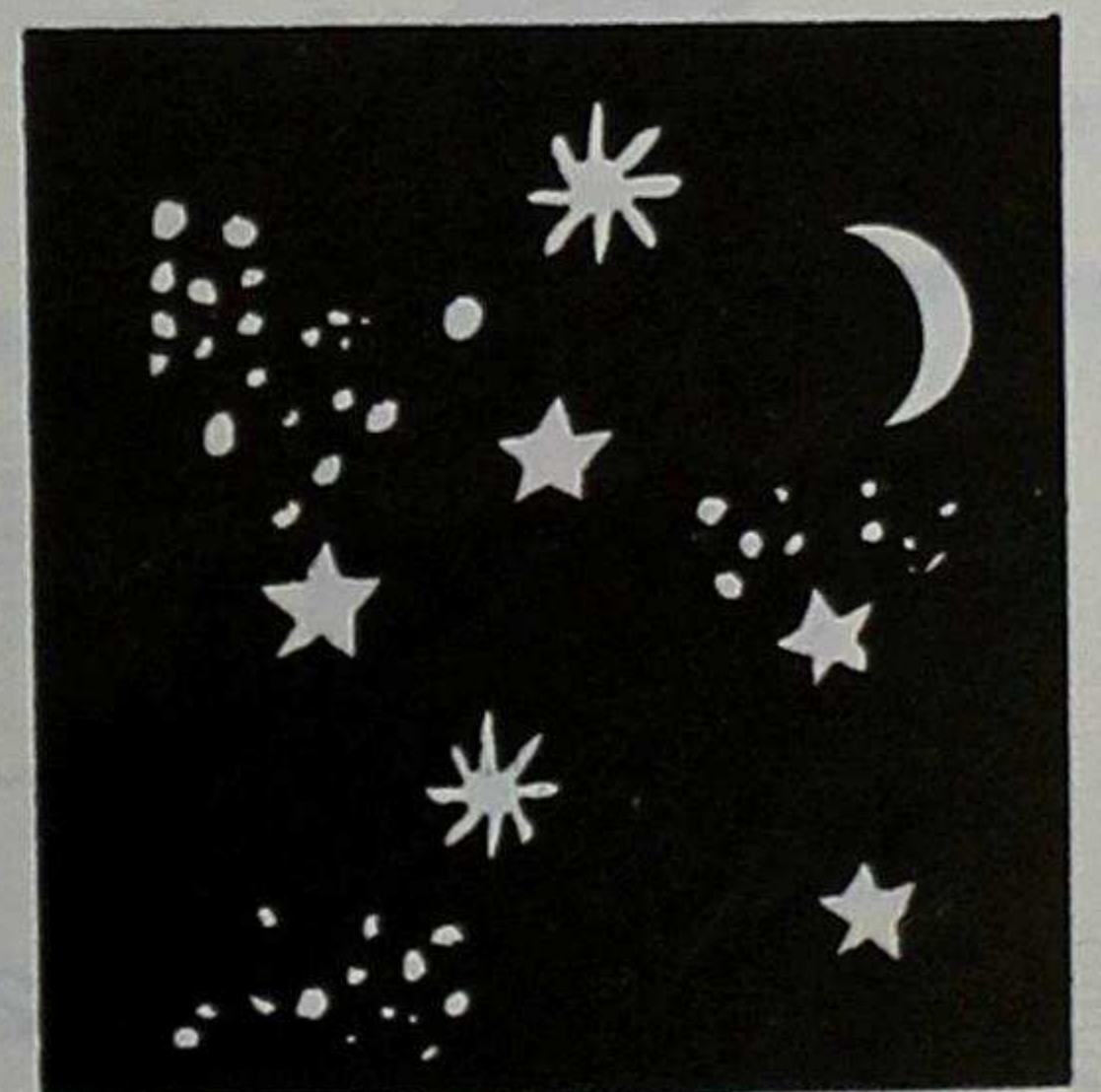

tuta



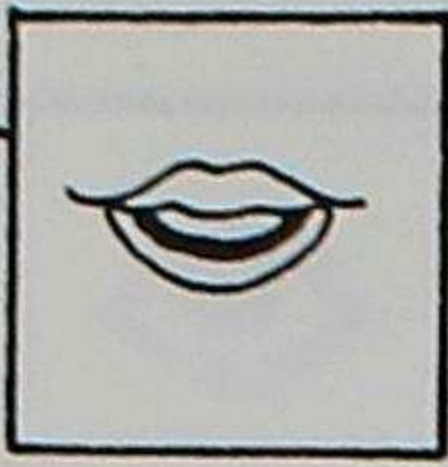

miau

hua  
hua

ma  
ma

huau

chiu  
chiu

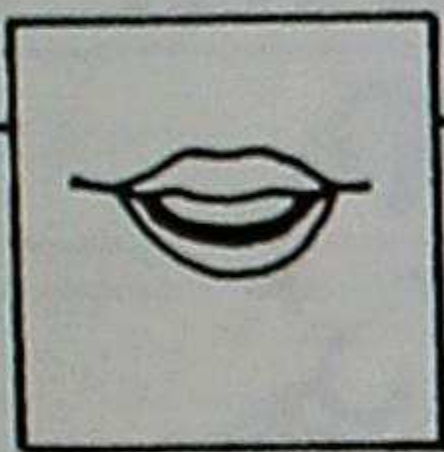

Cunan tuta cunuta nini.

tuta

cunuta

nini

tu ta

cu nu

ni ni

tu

cu

tu ta ti

ca cu

ni na nu

t = T

c = C

n = N

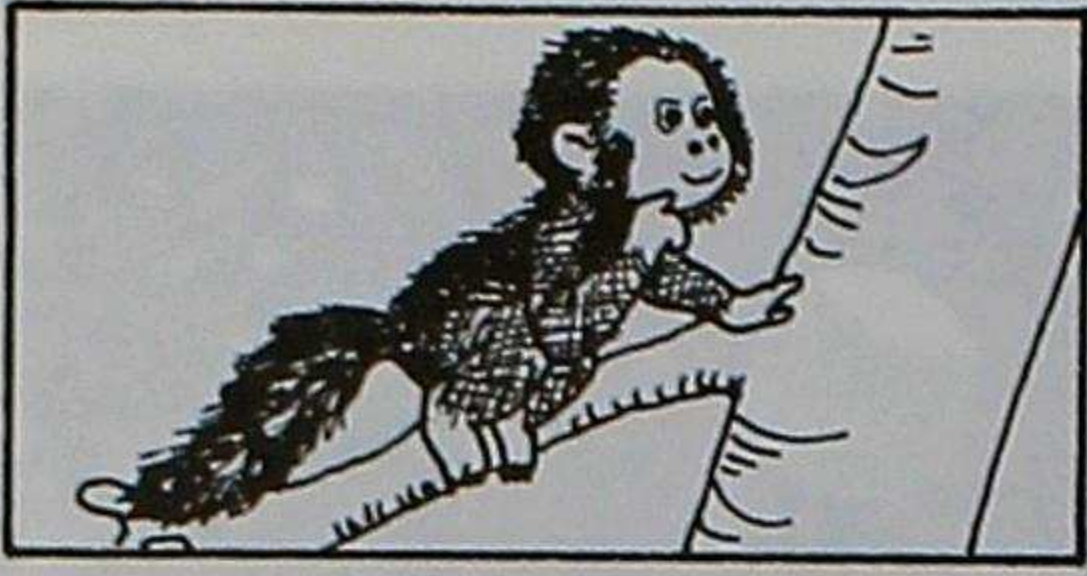
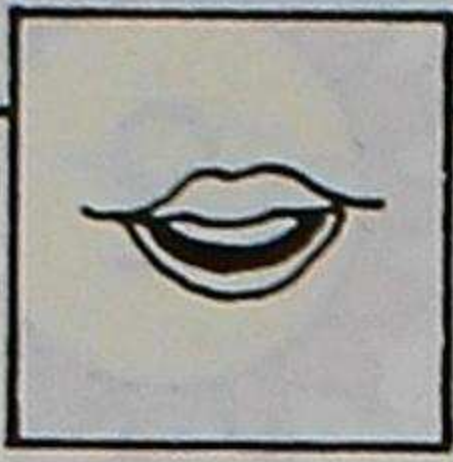

**titi**

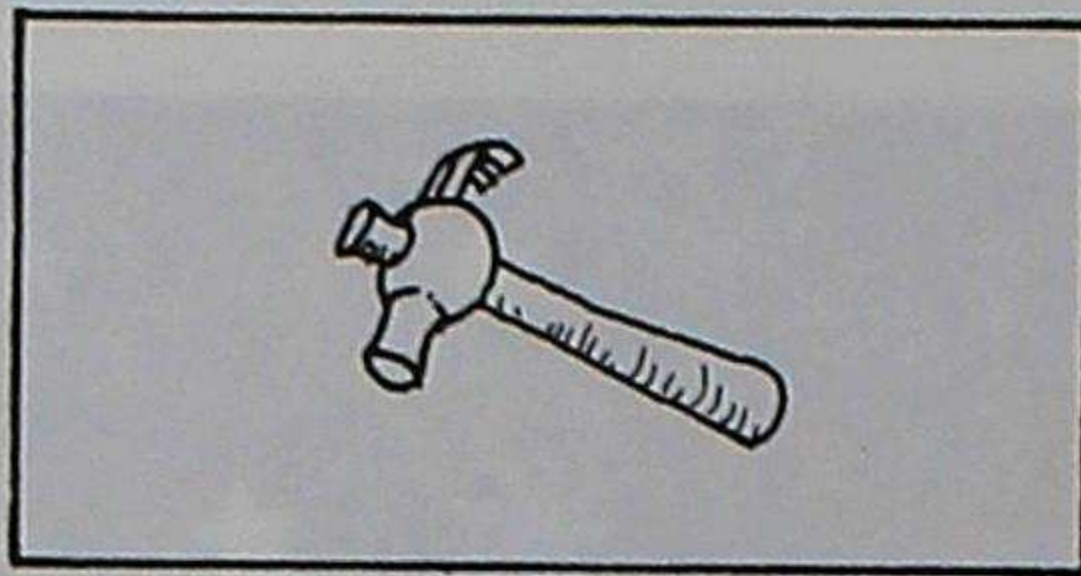

**tacana**

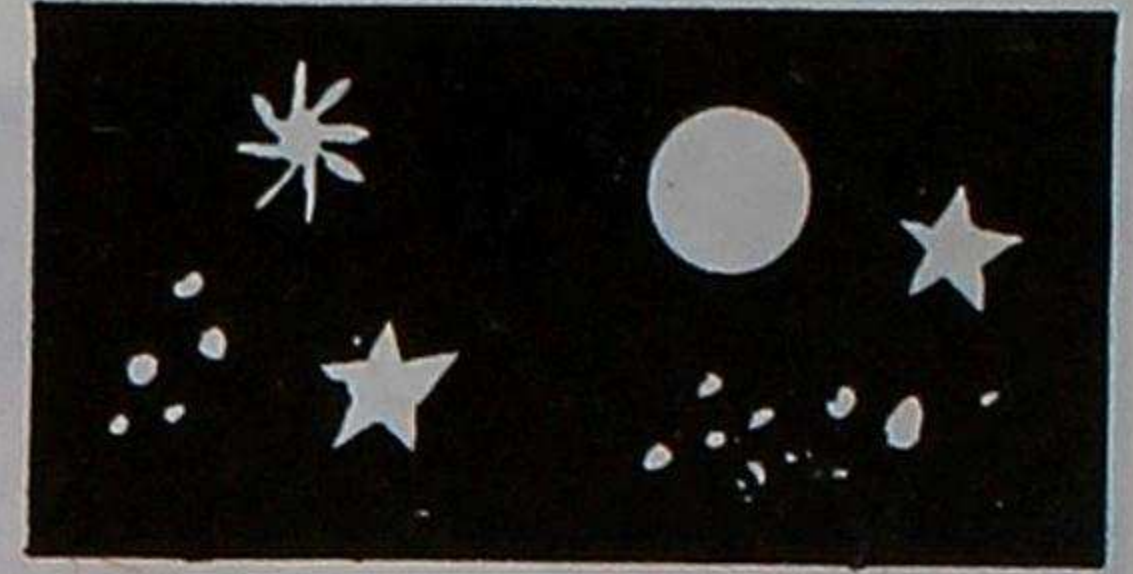

**tuta**

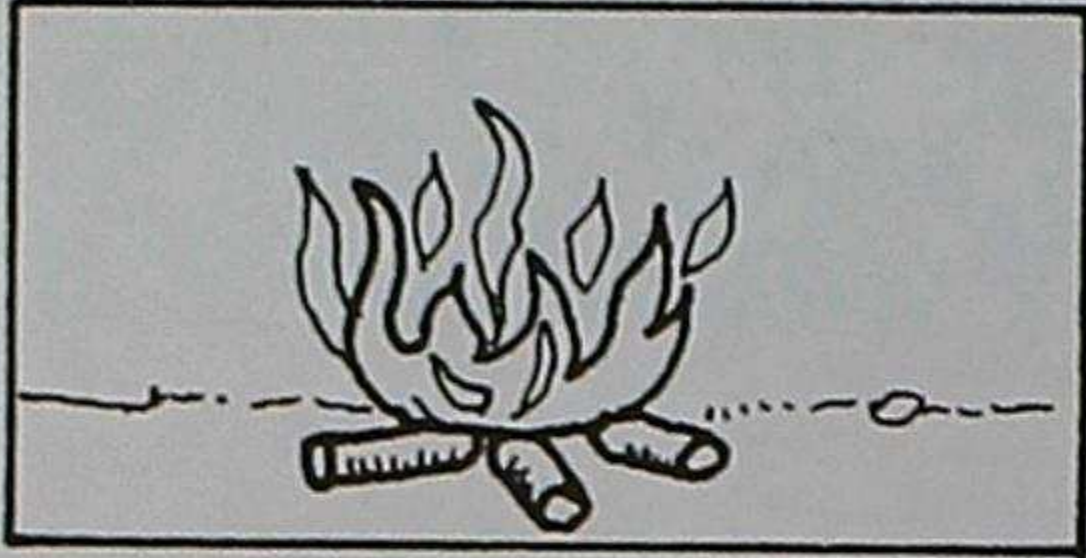

**nina**

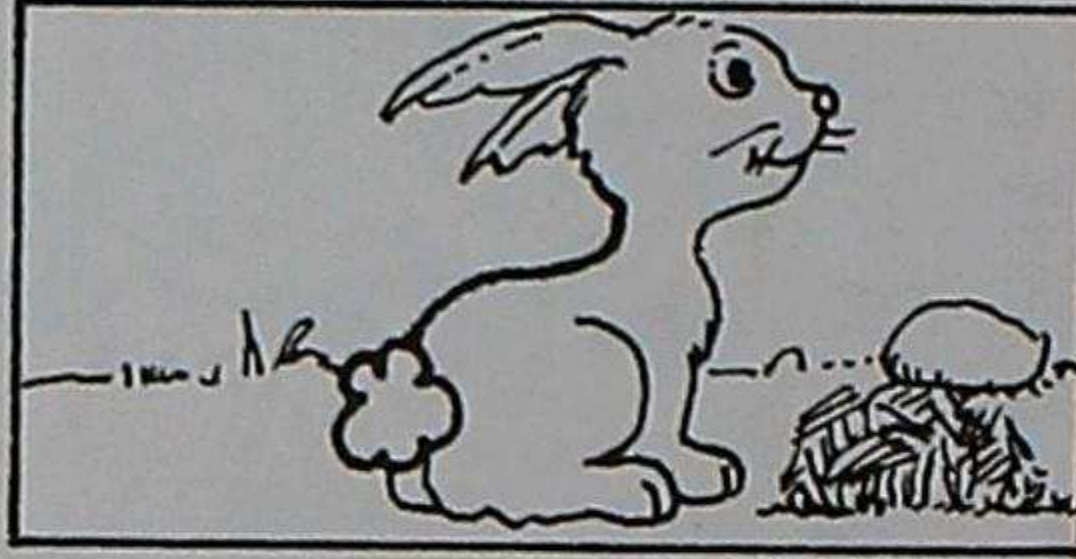

**cunu**



**nanai**

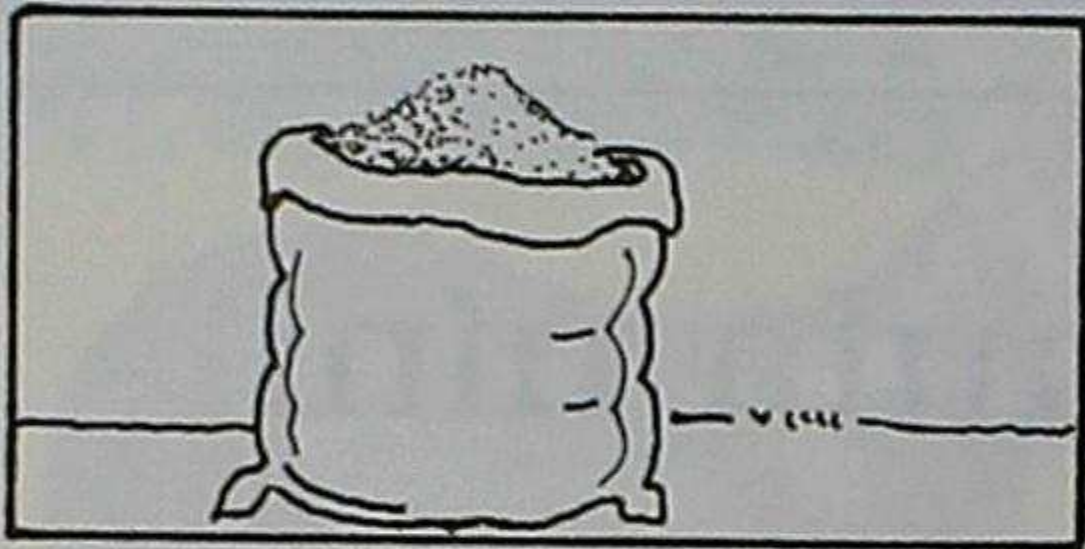

**cuta**

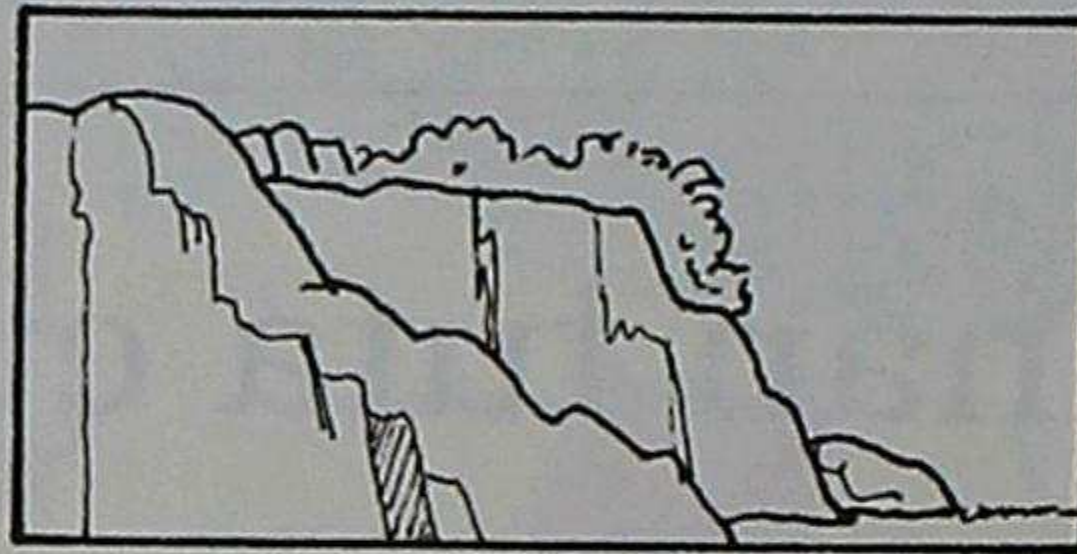

**caca**



**cutu**

<b>tacai</b>	<b>titi</b>	<b>tutu</b>
<b>cuta</b>	<b>cuti</b>	<b>cutu</b>
<b>taita</b>	<b>catiu</b>	<b>catui</b>

<b>nanai</b>	<b>nina</b>	
<b>ana</b>	<b>pani</b>	<b>cunu</b>
<b>ananai</b>		<b>cunui</b>

<b>caca</b>	<b>cunu</b>
<b>pacani</b>	<b>ucu</b>
<b>cai</b>	<b>cui</b>



cunu

cunuc**u**  
cunu**ca**  
cunu**ta**  
cunu**pi**

tuta

tutac**u**  
tutac**a**  
tutata**ta**  
tutapi**pi**

nina

ninac**u**  
ninac**a**  
ninata**ta**  
ninapi**pi**

pacana

pacac**uni**

- \* Cai taitaca cunuta catin.
- \* Cai anacucuta nini.
- \* Catucuca cuicunata catin.
- \* Cai titicuta catui.
- \* Ninapi cunucuni.
- \* Tutapi papata nini.
- \* Paica papata micunca.

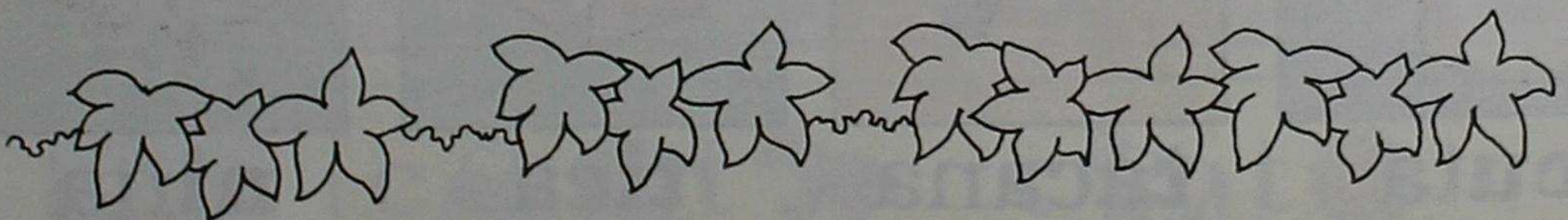

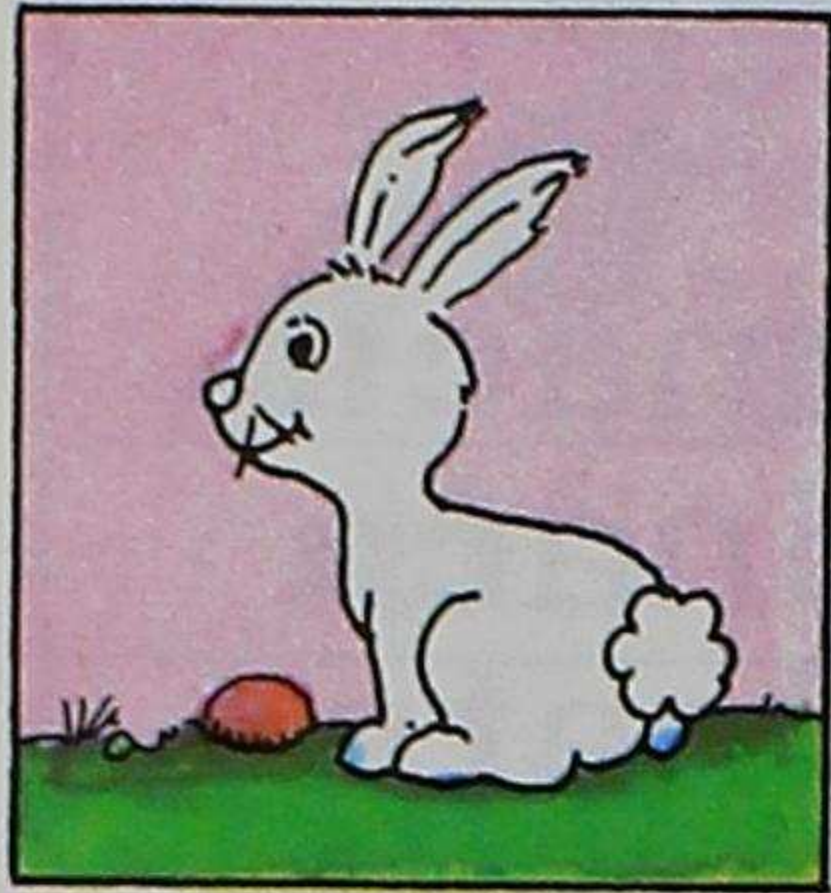
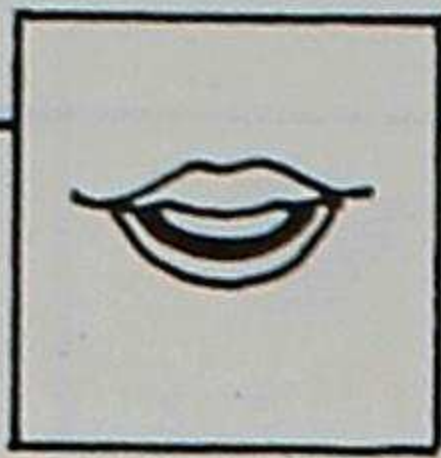

**cunu**

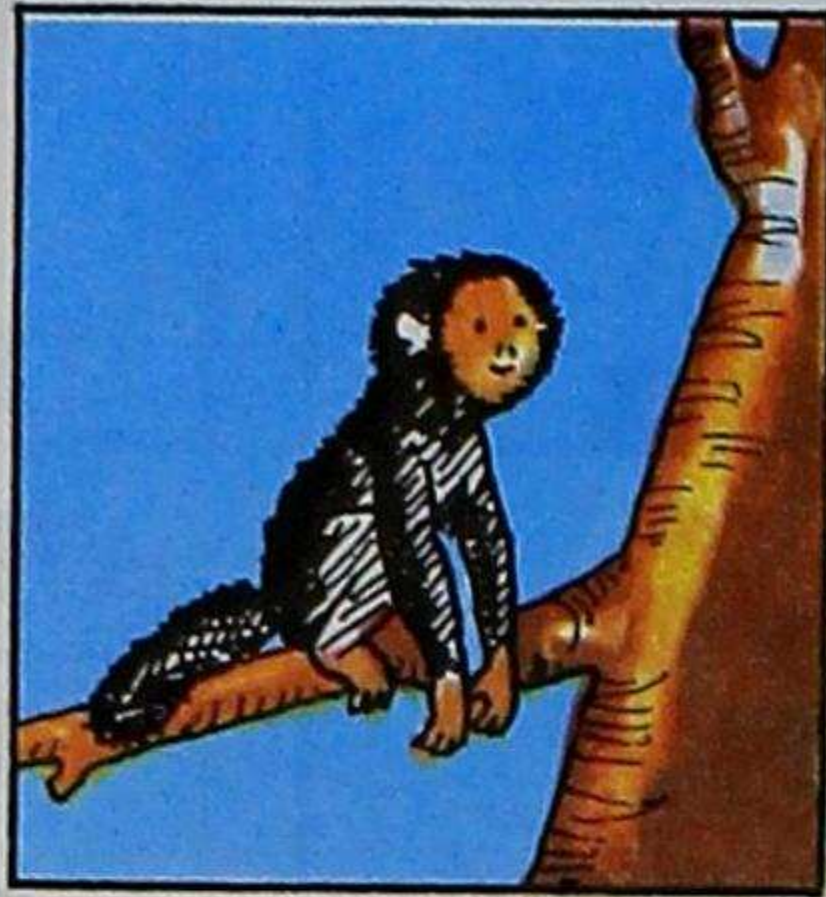

**titi**

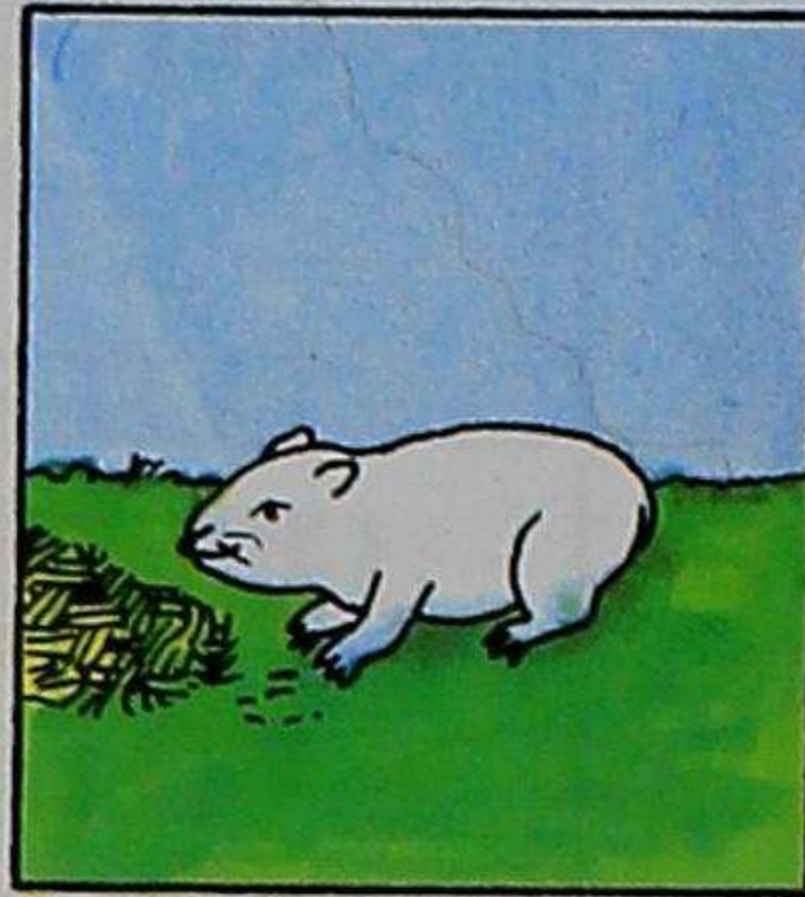

**cui**

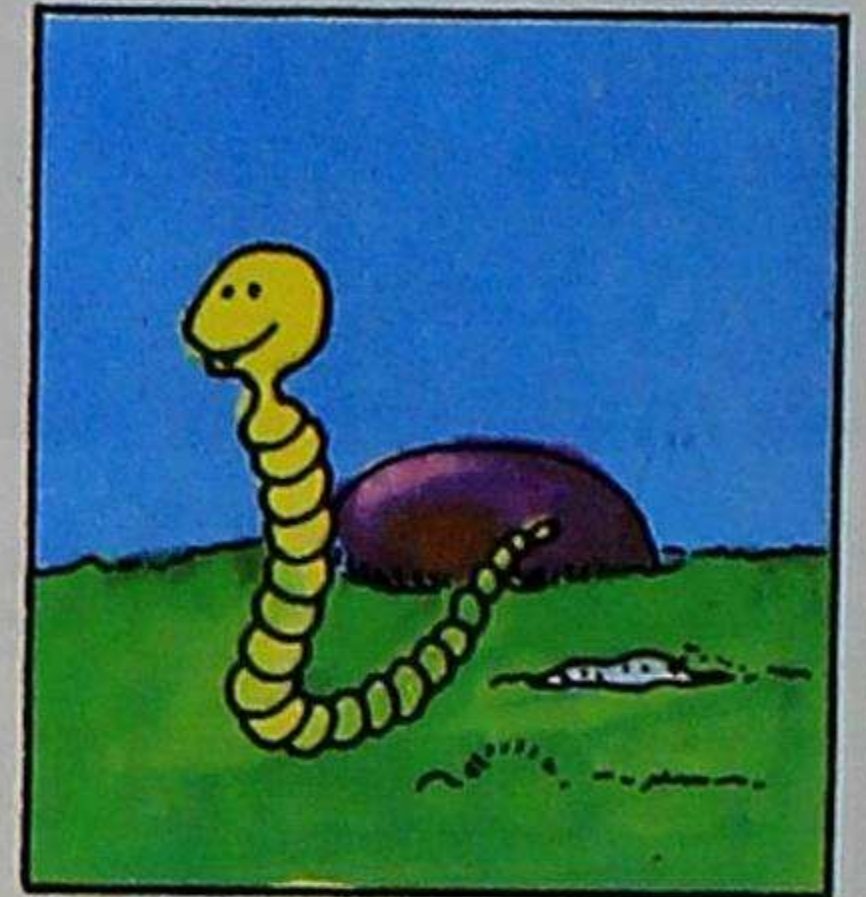

**cuica**



**cutu**



**ana**



**taita**

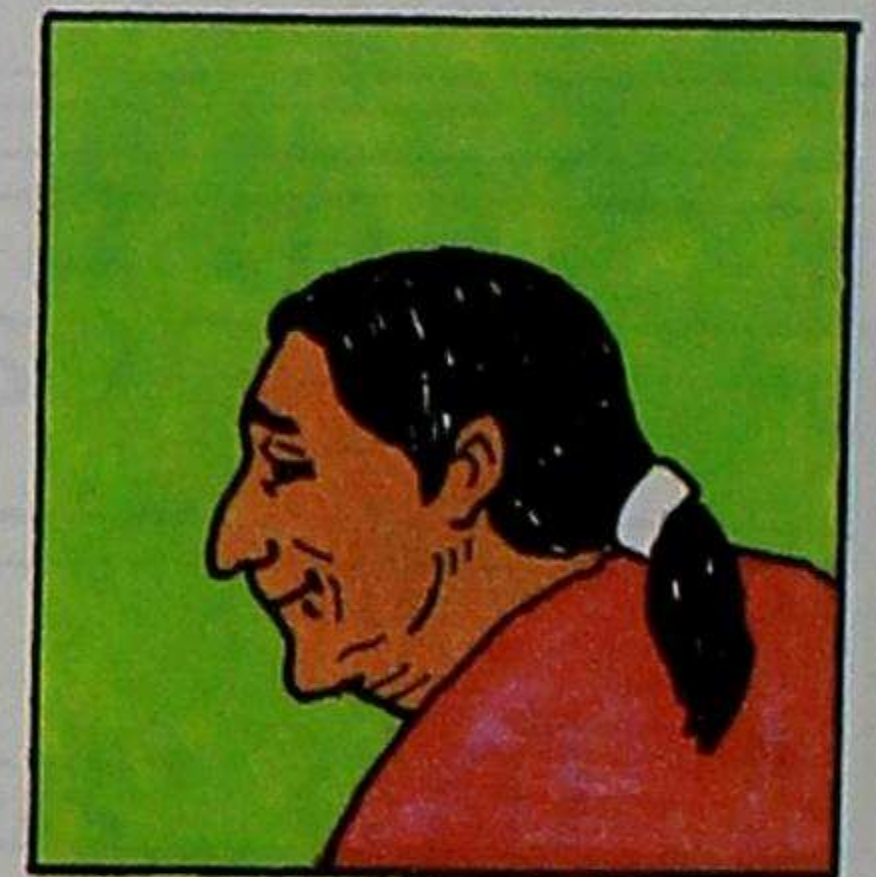

**catucu**

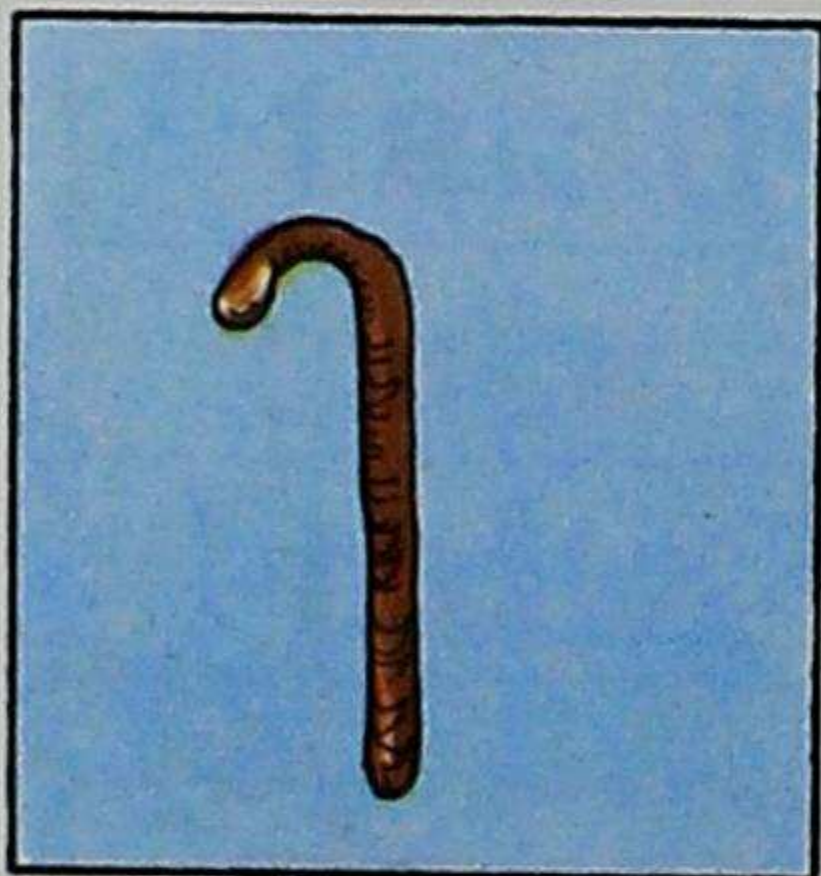

**tauna**

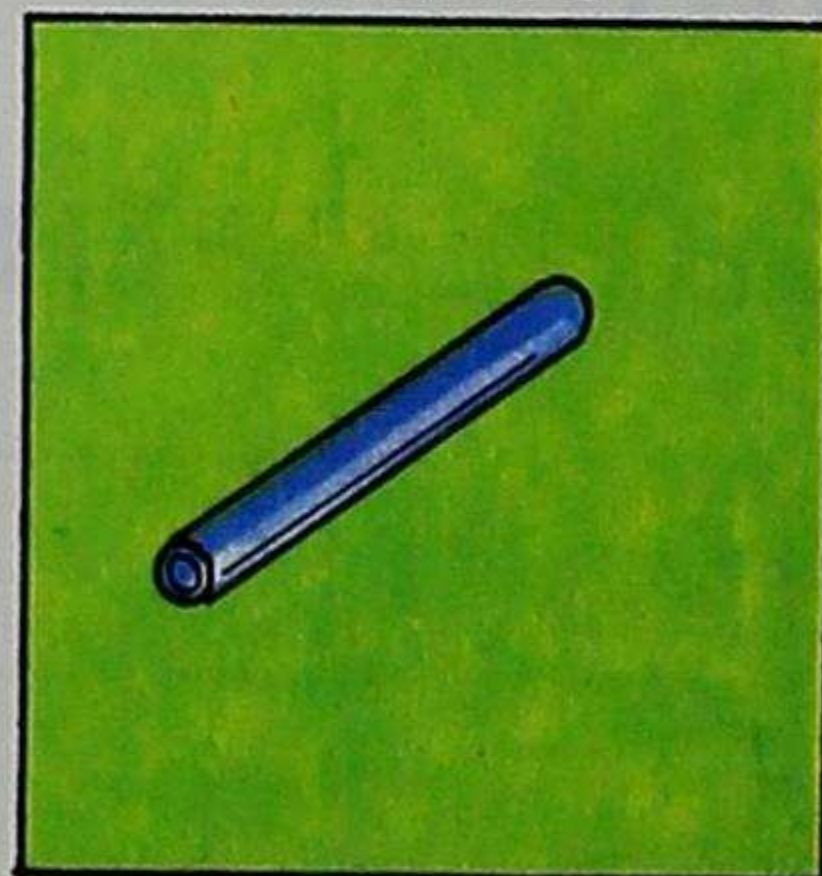

**tutu**

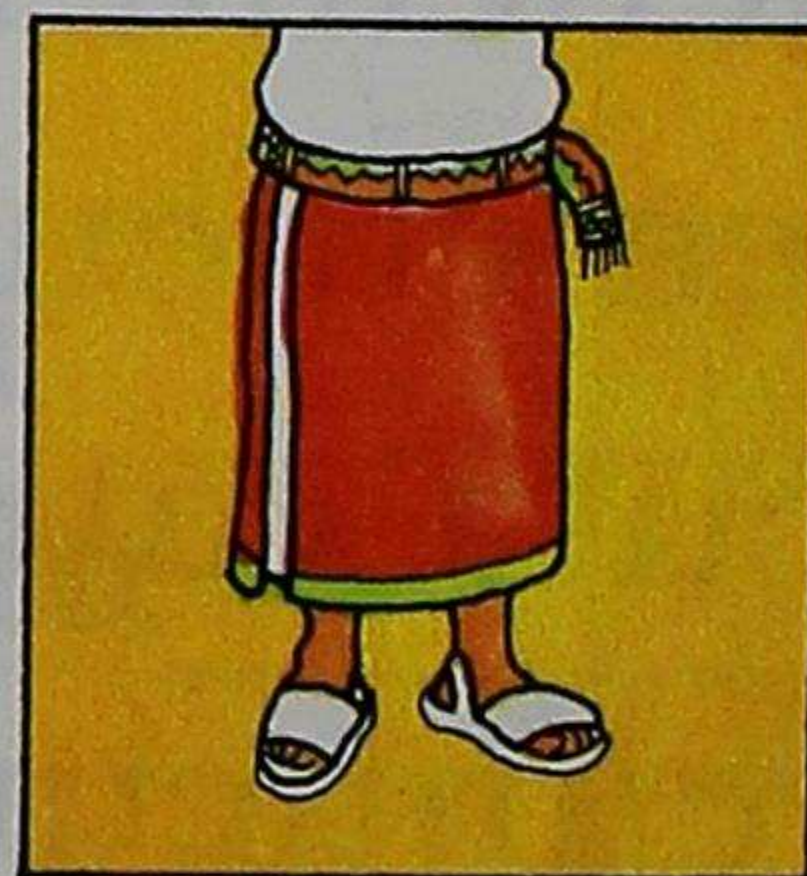

**anacu**

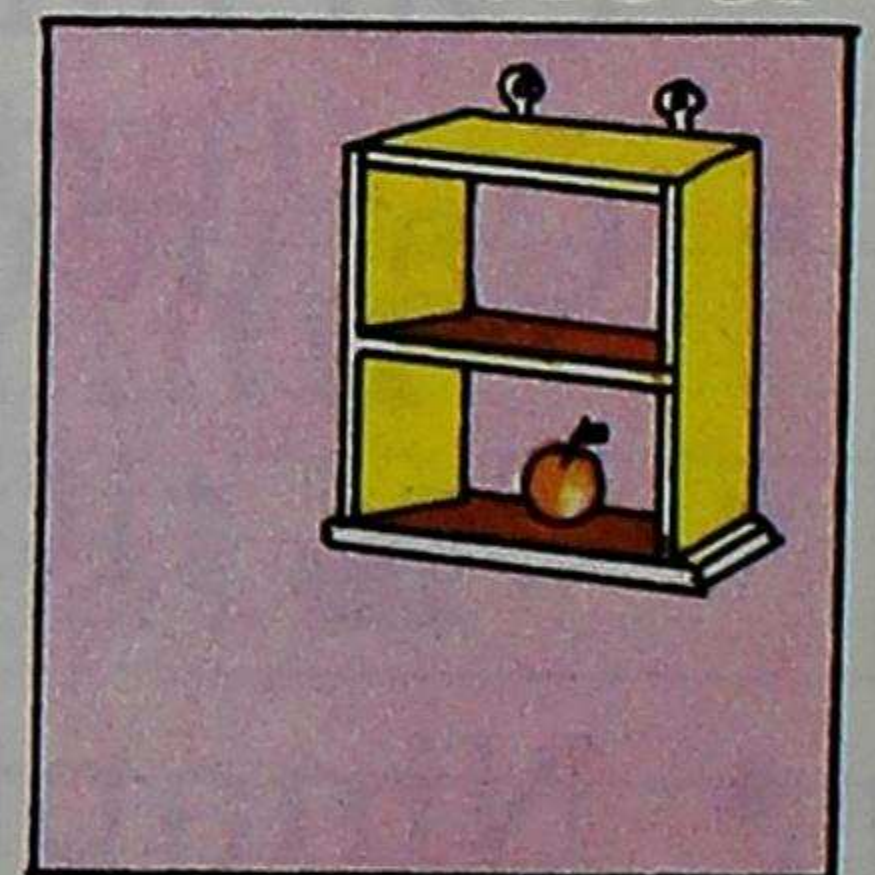

**tucu**

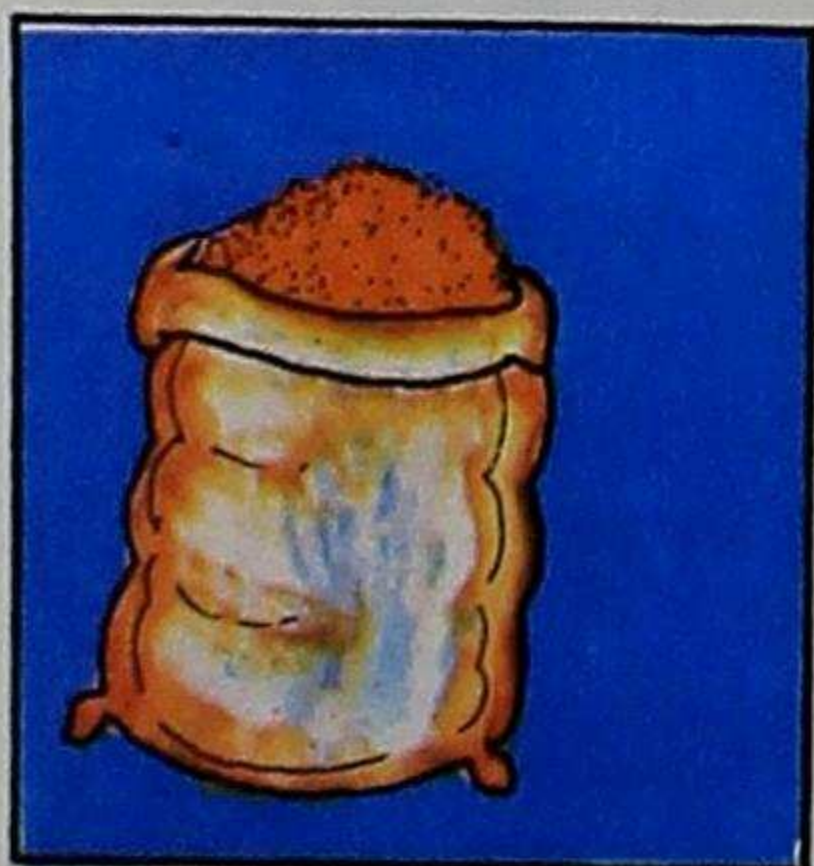

**cuta**

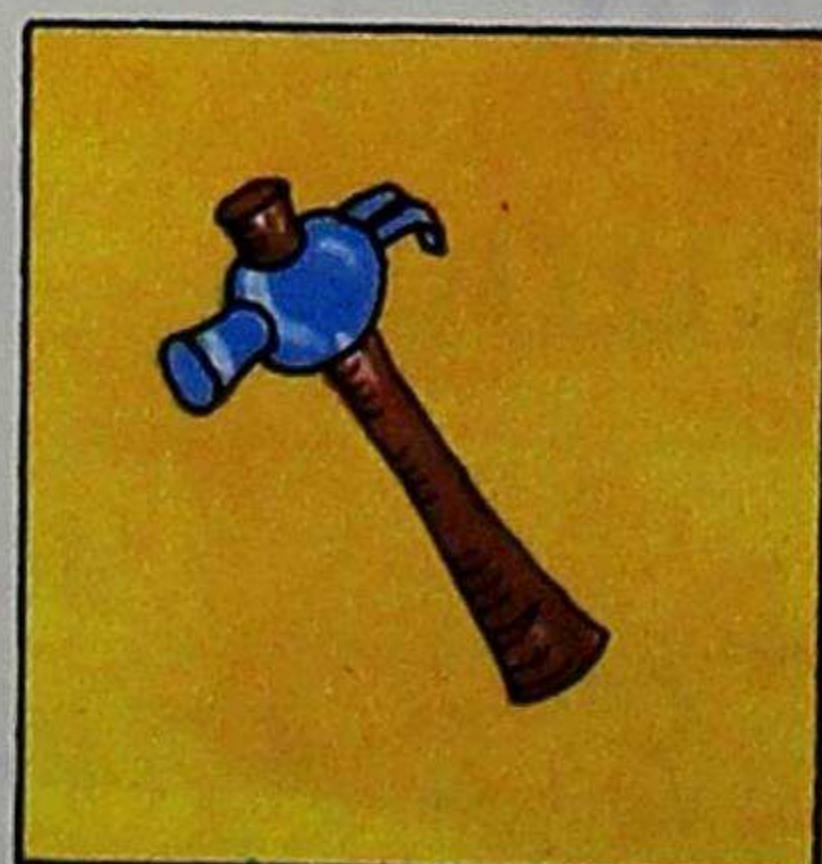

**tacana**

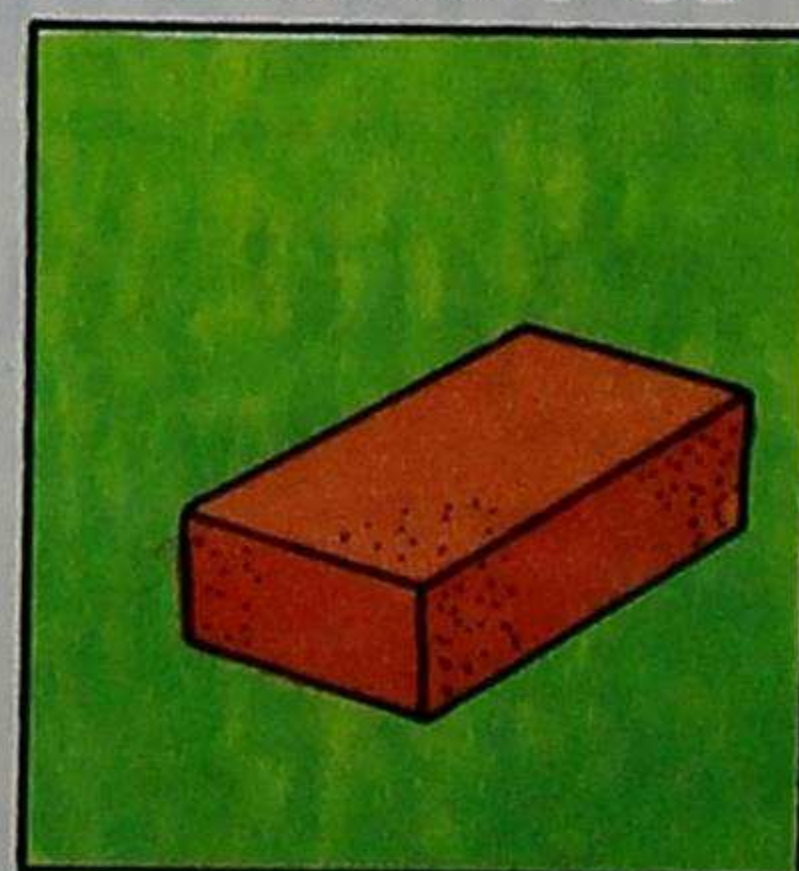

**tica**

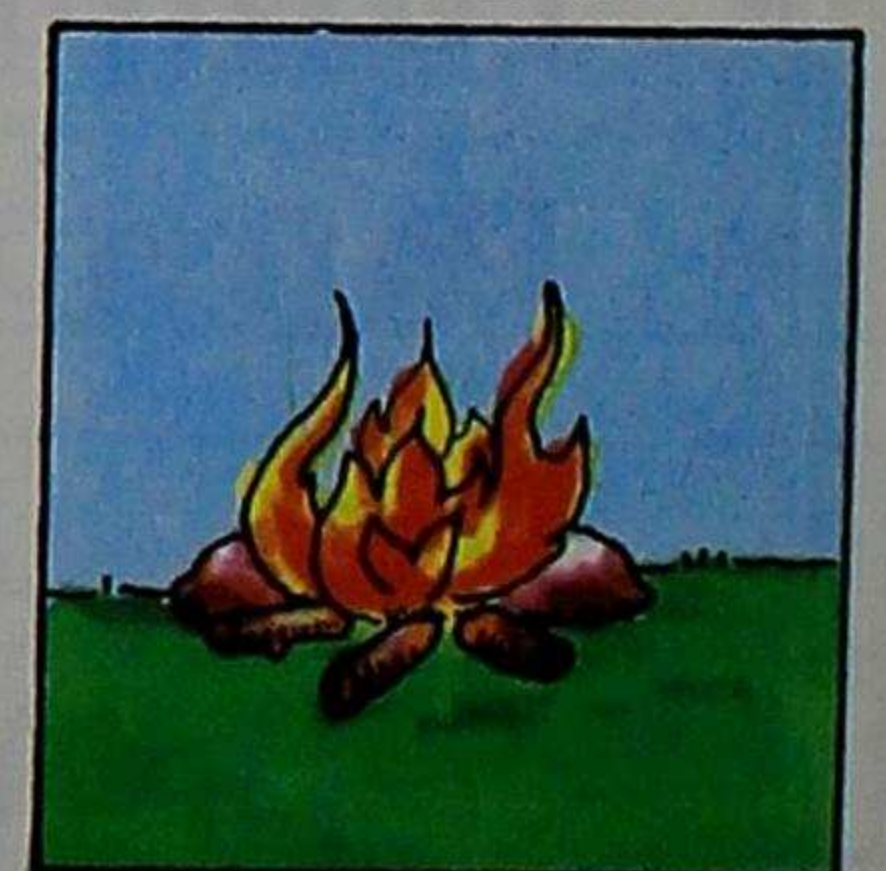

**nina**

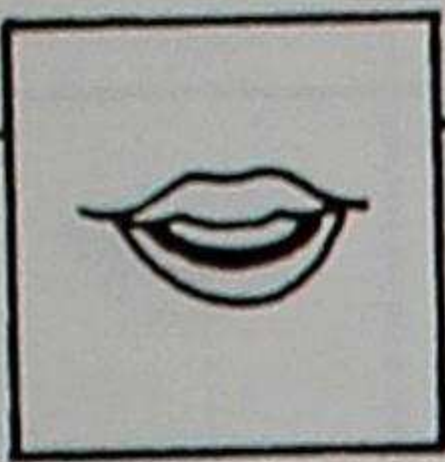

\* Cai  ta cati.

Cai cunuta cati.

\* Cai  ta ca catui.

Cai ticataca catui.

\* Cai  ta cati.

Cai cuita cati.

\* Cai  cu ta nini.

Cai ucacuta nini.

\* Cai  cu ta catini.

Cai cuicacuta catini.

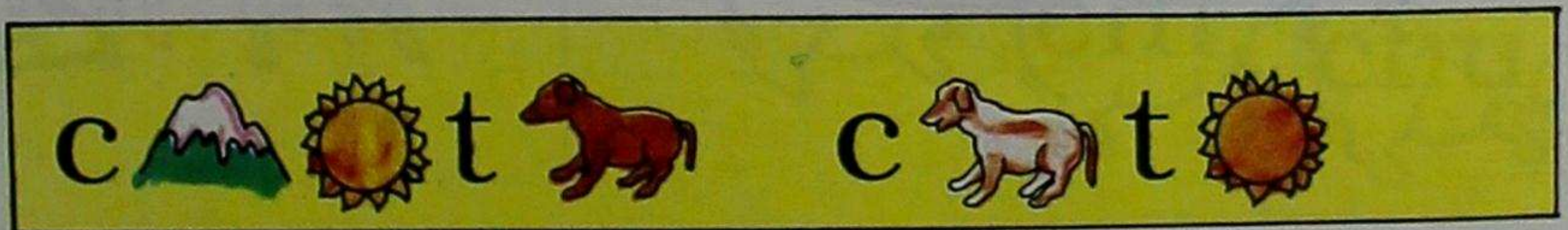
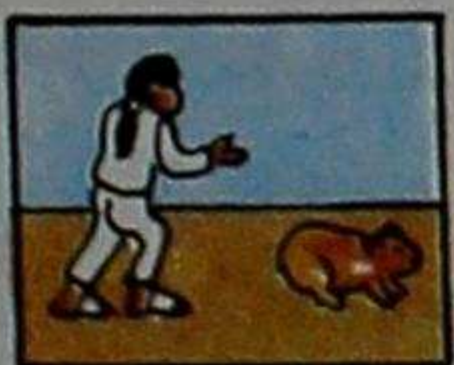
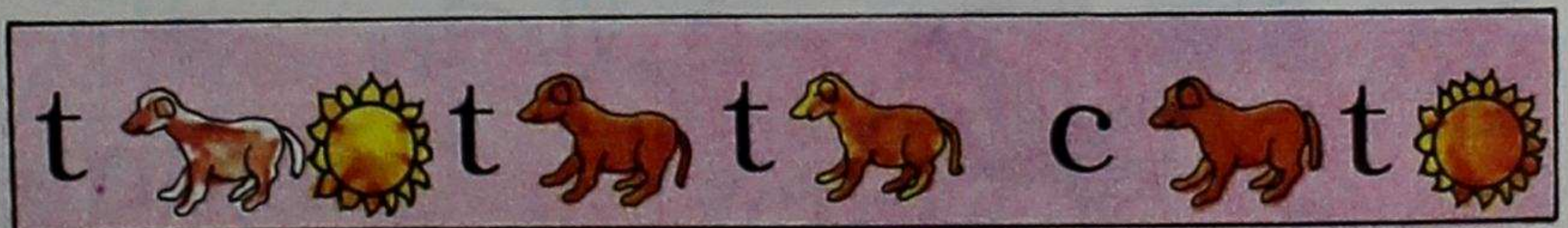
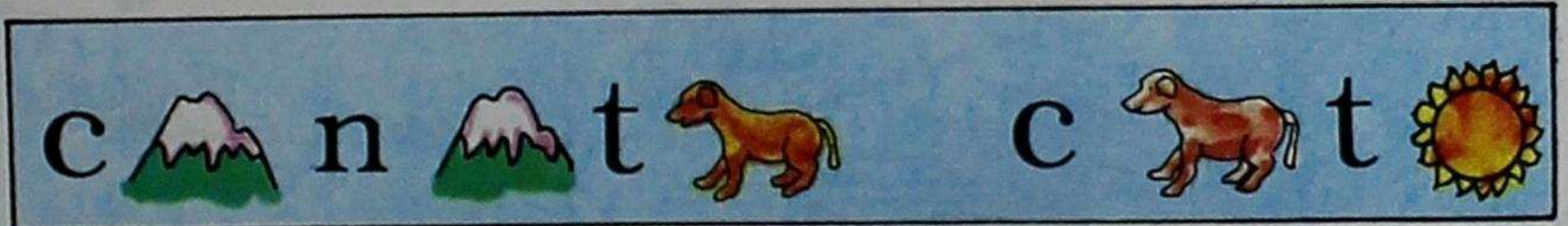
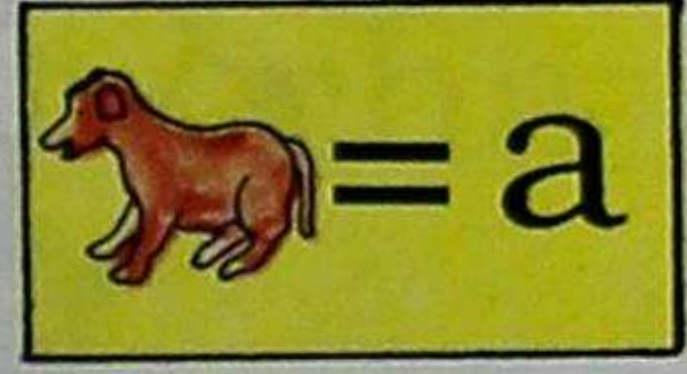
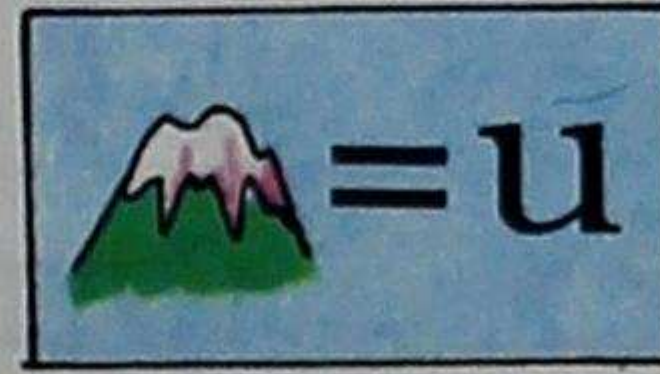
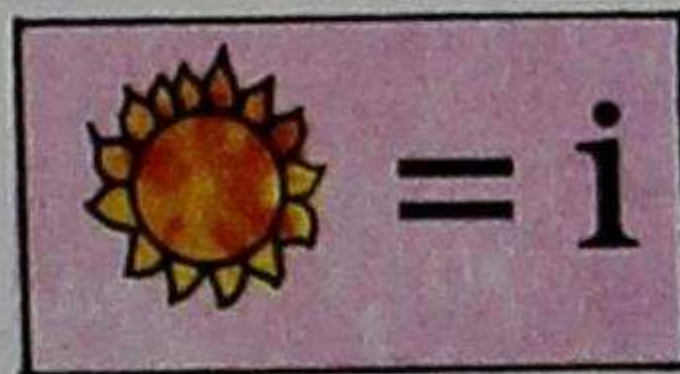
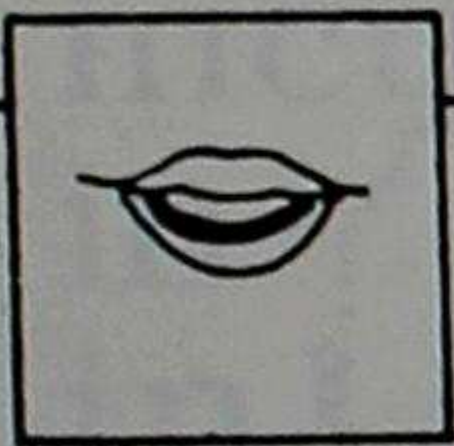

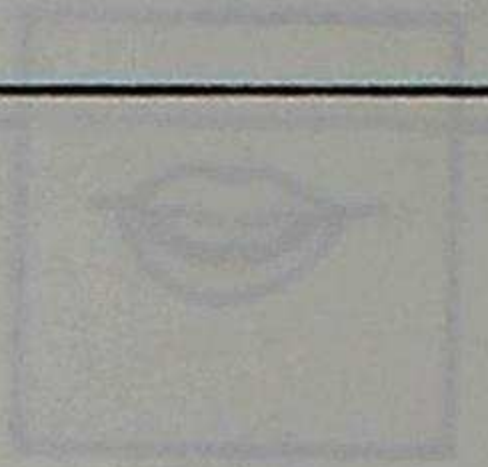
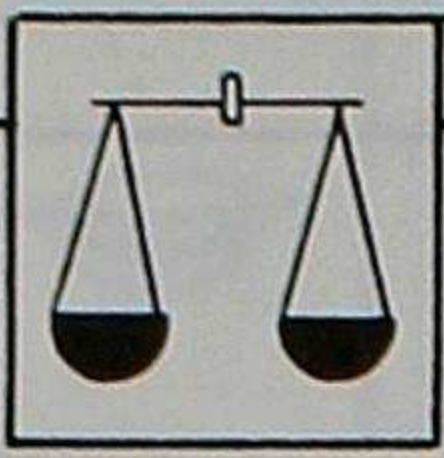

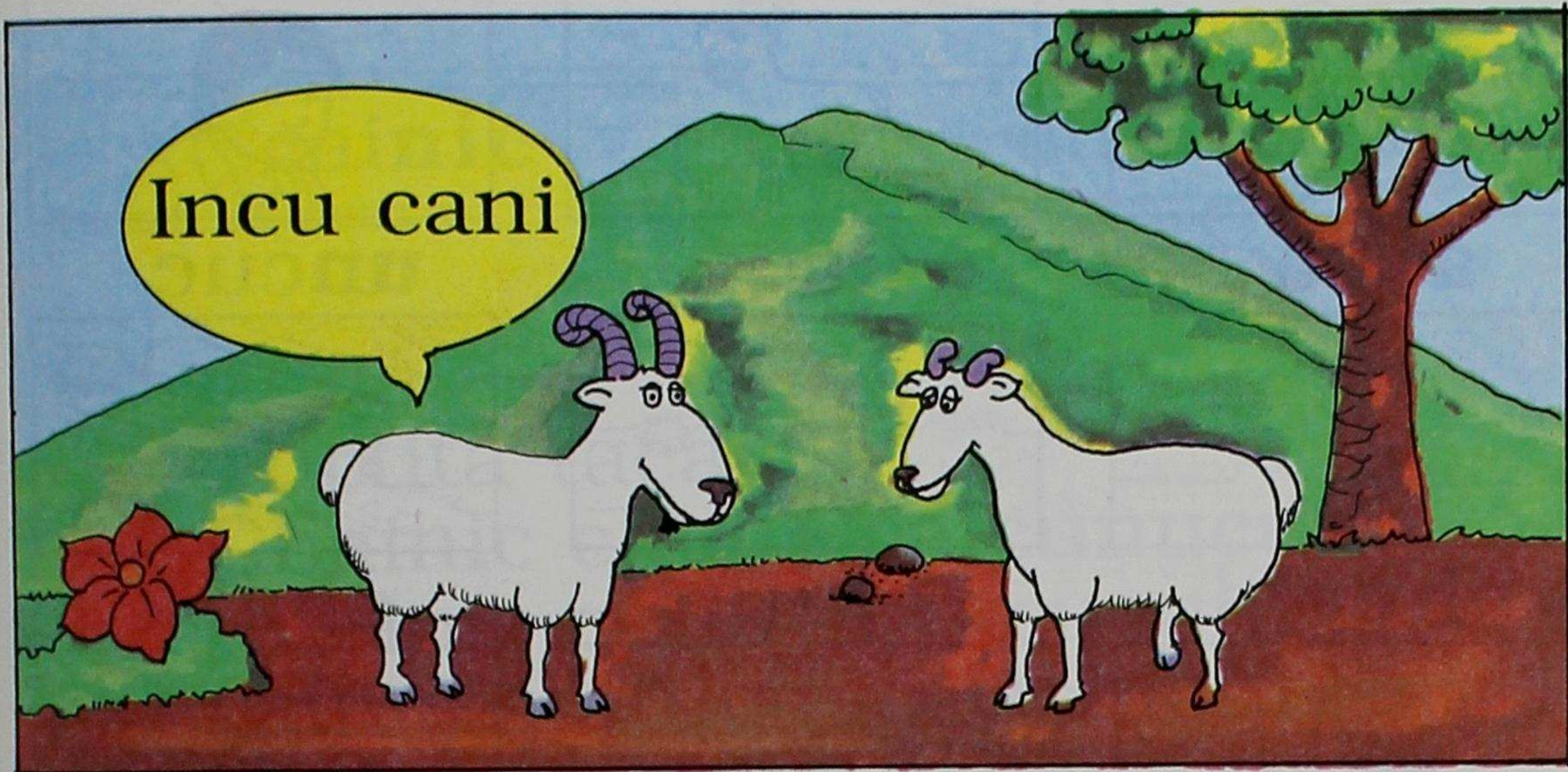
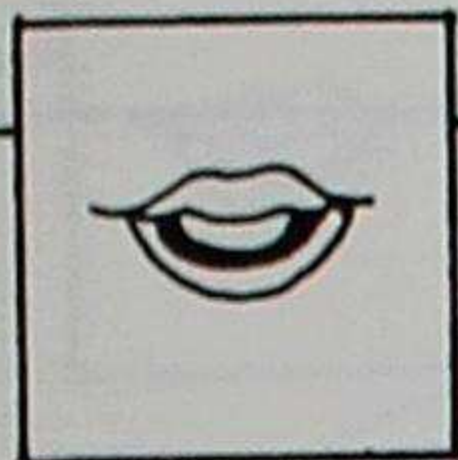

Incu cani. Cutu accha cani.

Incu cani  
incu  
in cu  
in

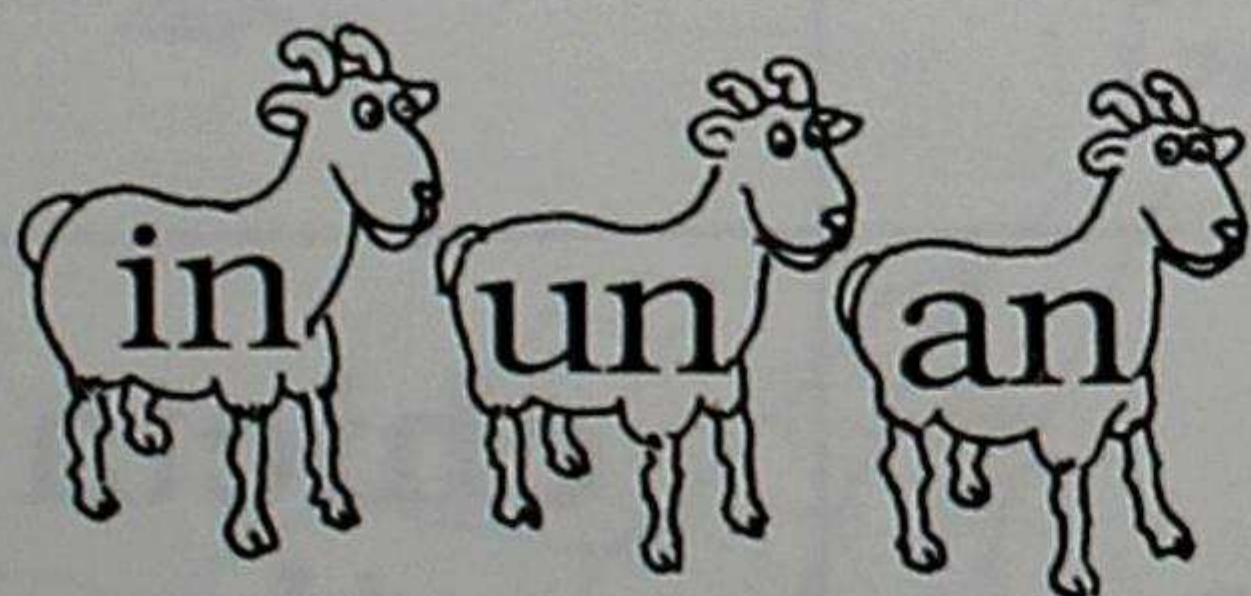

Cutu accha cani  
accha  
ac cha  
ac cha

ac

ic

uc





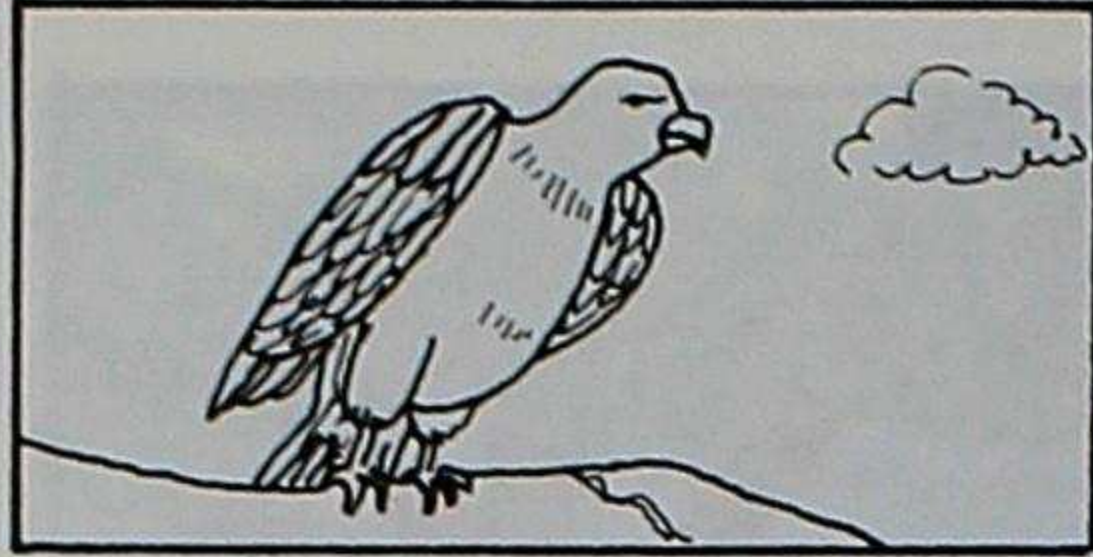
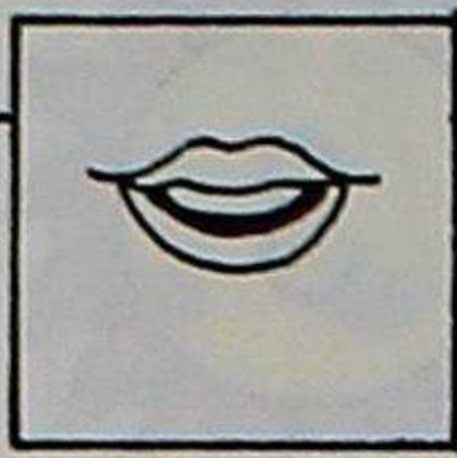

**anca**

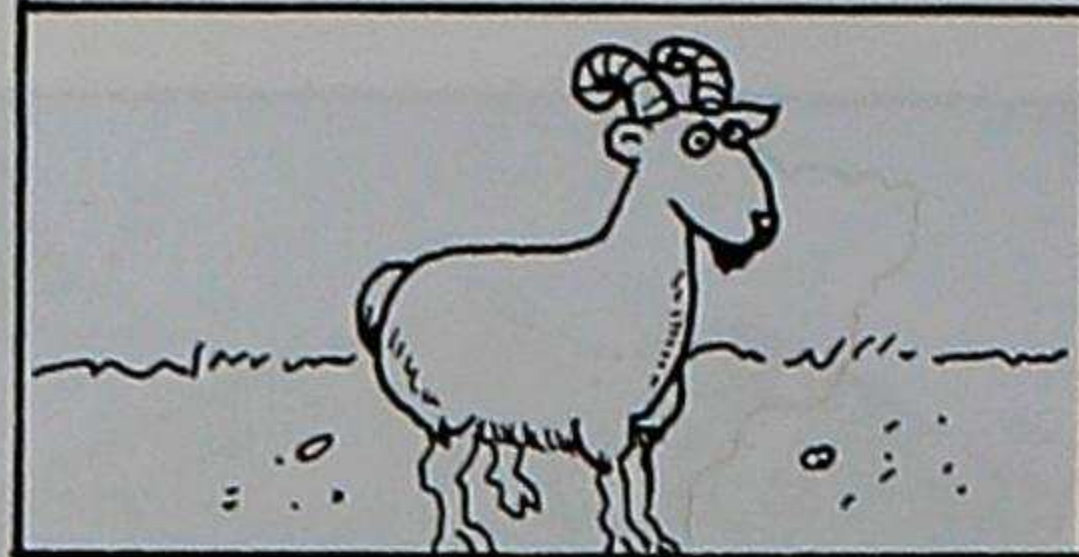

**incu**



**uncuc**

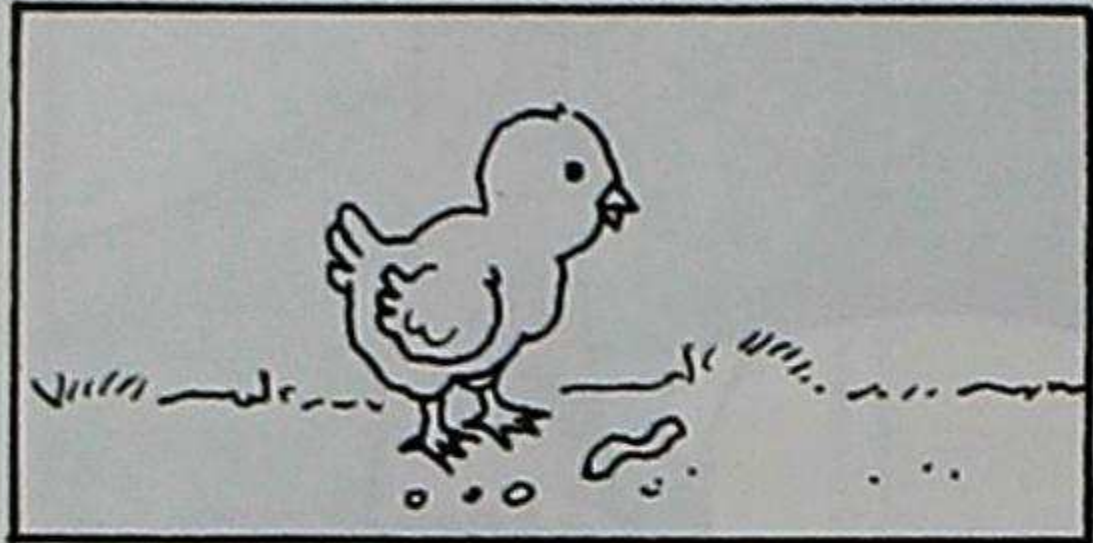

**chuchi**

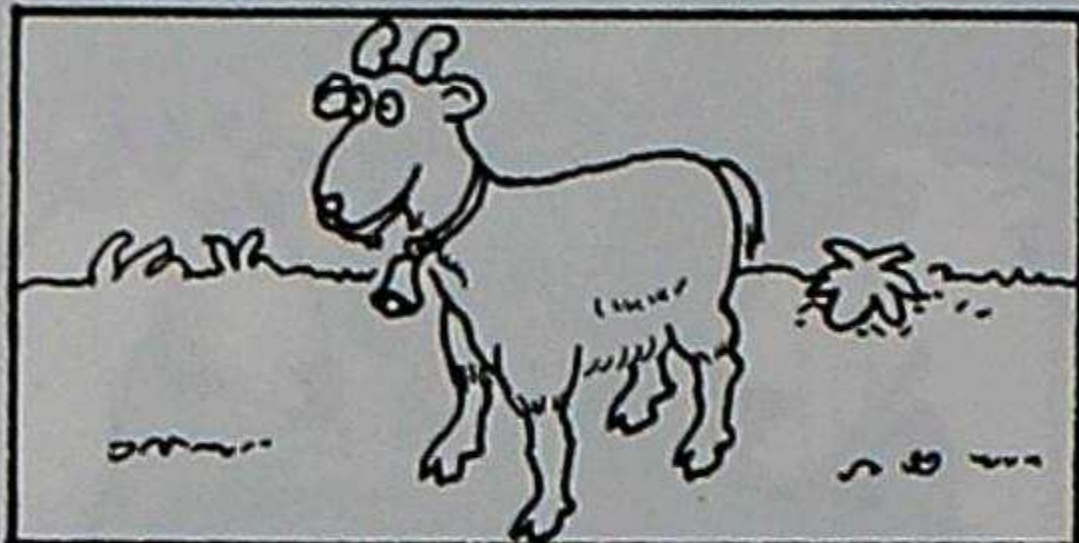

**chita**

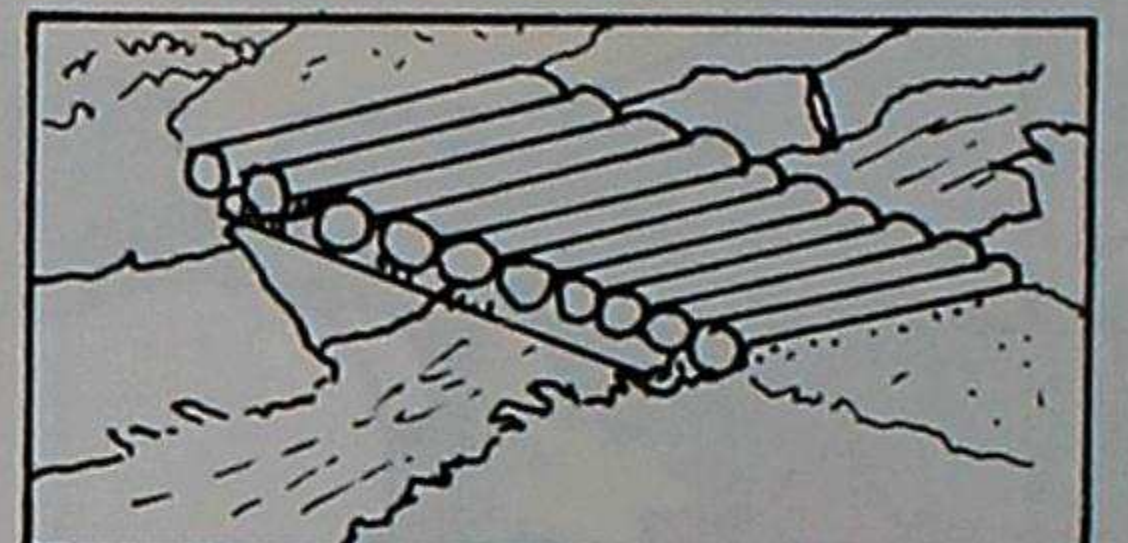

**chaca**

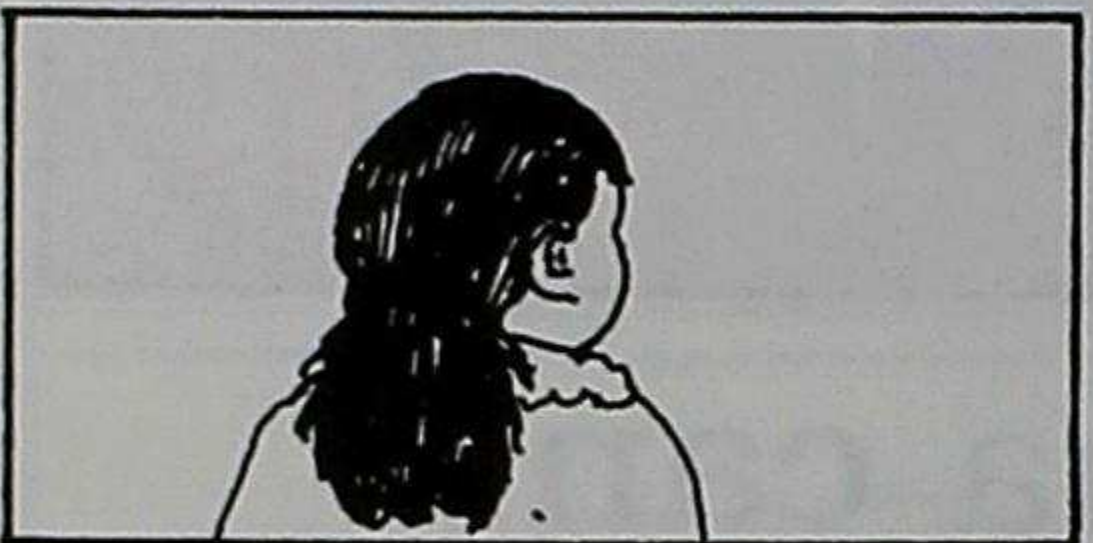

**accha**

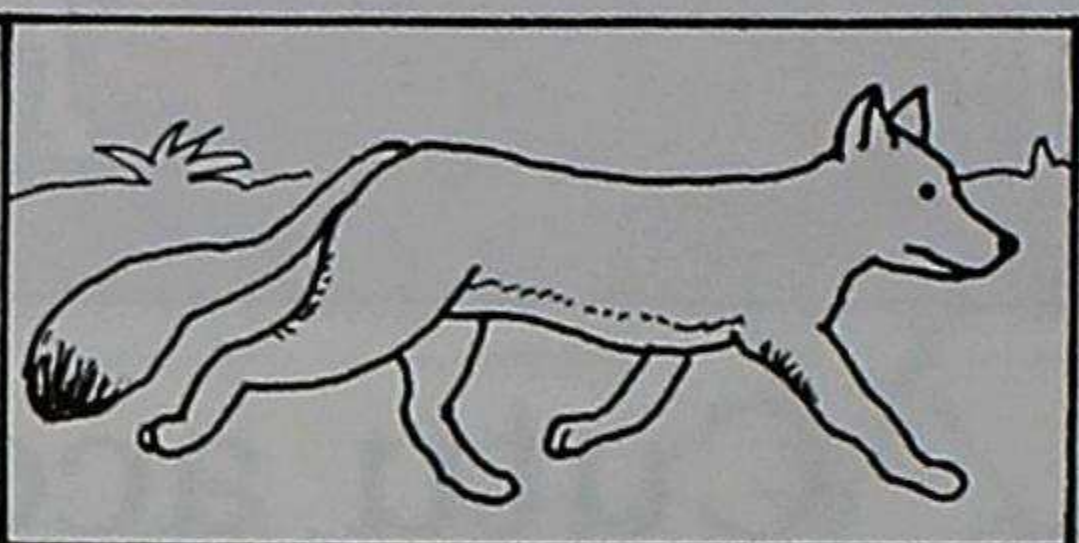

**atuc**



**chicta**

<b>anca</b> <b>canca</b>	<b>incu</b> <b>catin</b> <b>tincuna</b>	<b>uncuna</b> <b>cunca</b>
<b>chaca</b> <b>cucha</b> <b>chanca</b> <b>chai</b>	<b>chichu</b> <b>cachi</b> <b>chicta</b> <b>chiu</b>	<b>chucu</b> <b>cuchu</b> <b>chunca</b>
<b>accha</b>	<b>atuc</b>	<b>chicta</b> <b>catic</b>



cai

cainic

cununa

cunuchina

- \* Tuctita tacachin
- \* Chainic chuchica cunucun.
- \* Chainic cunuca utcucun.
- \* Cunuca atucta catichacun.
- \* Cunanca chita aichata nini.
- \* Incuca cainic ucuta nin.

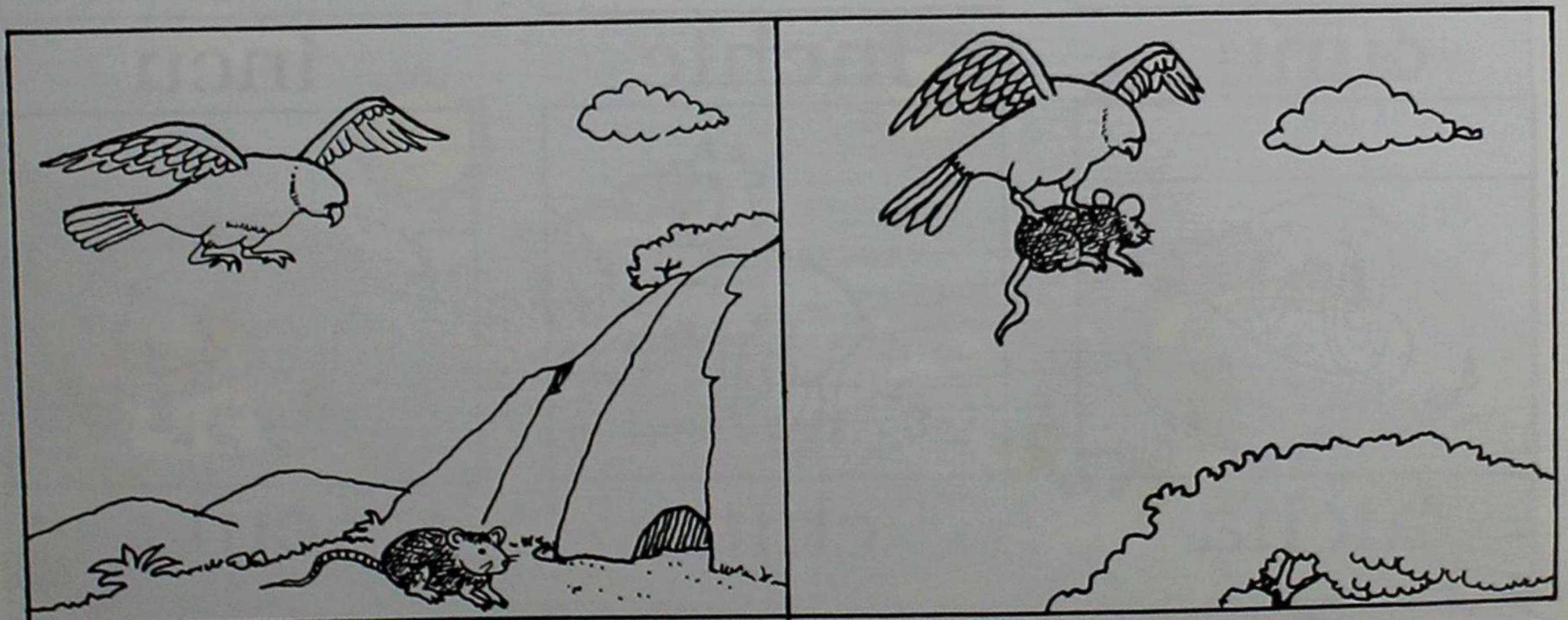

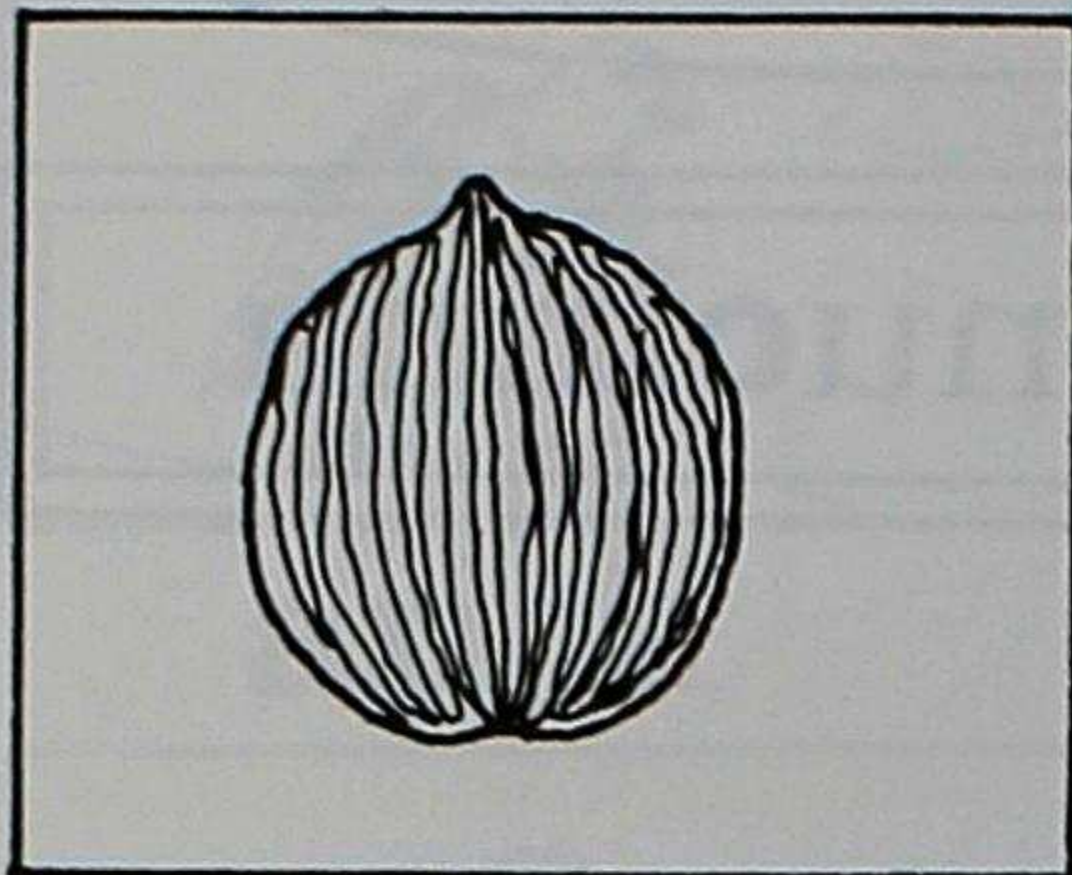
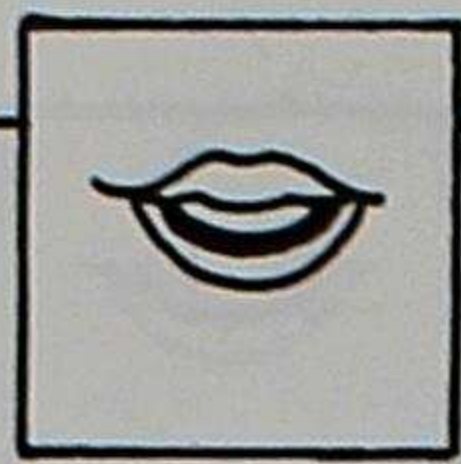

tucti

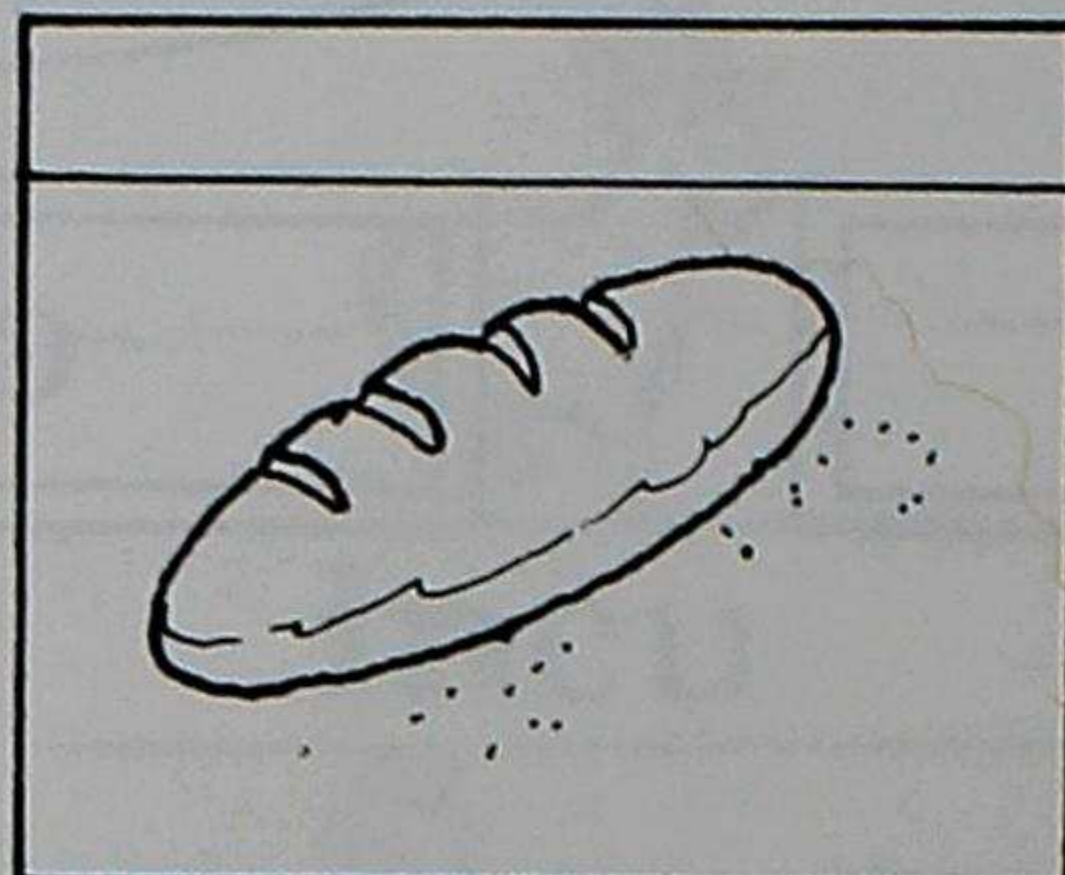

tanta

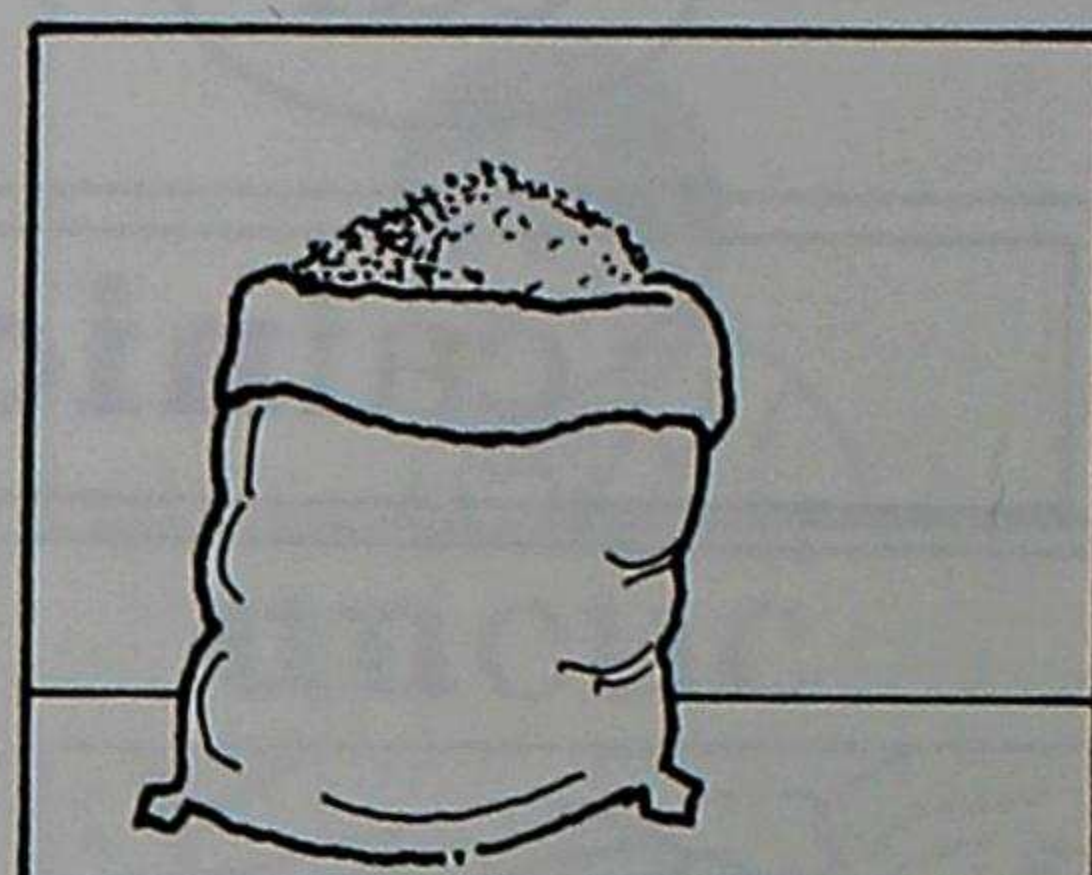

cuta

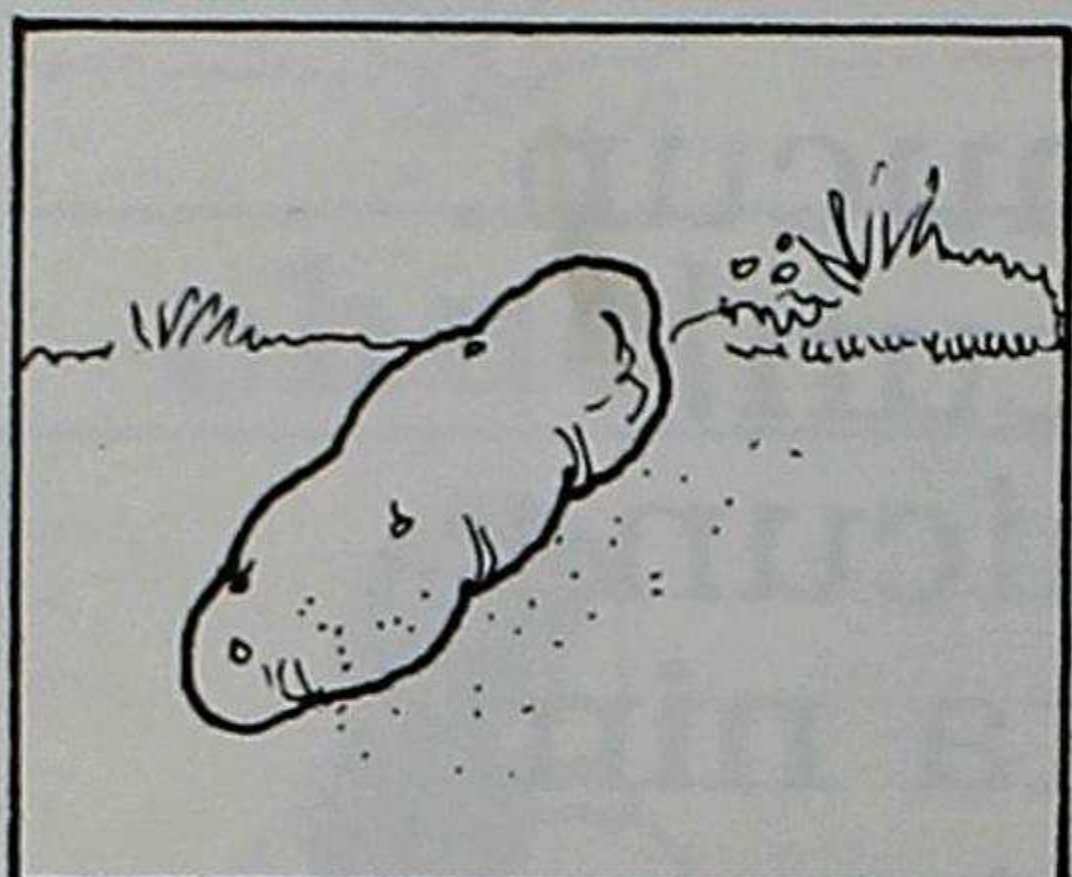

uca

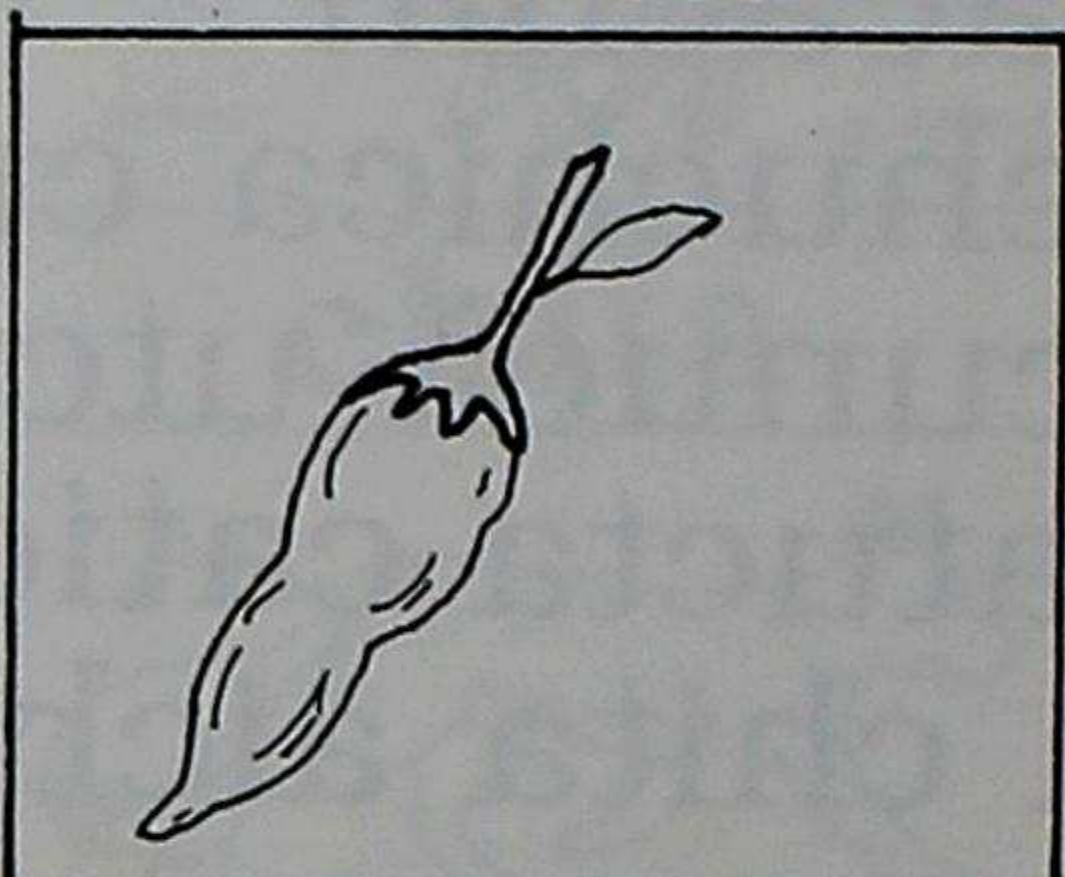

uchu

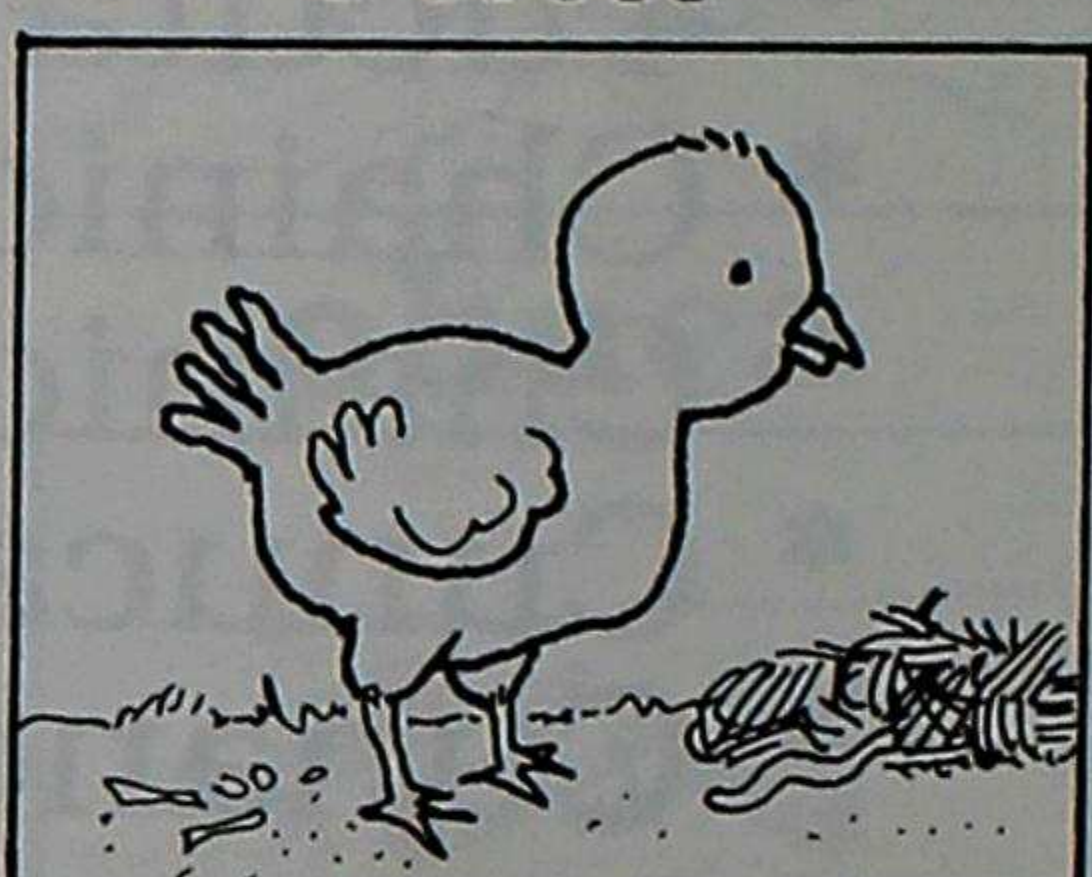

chuchi

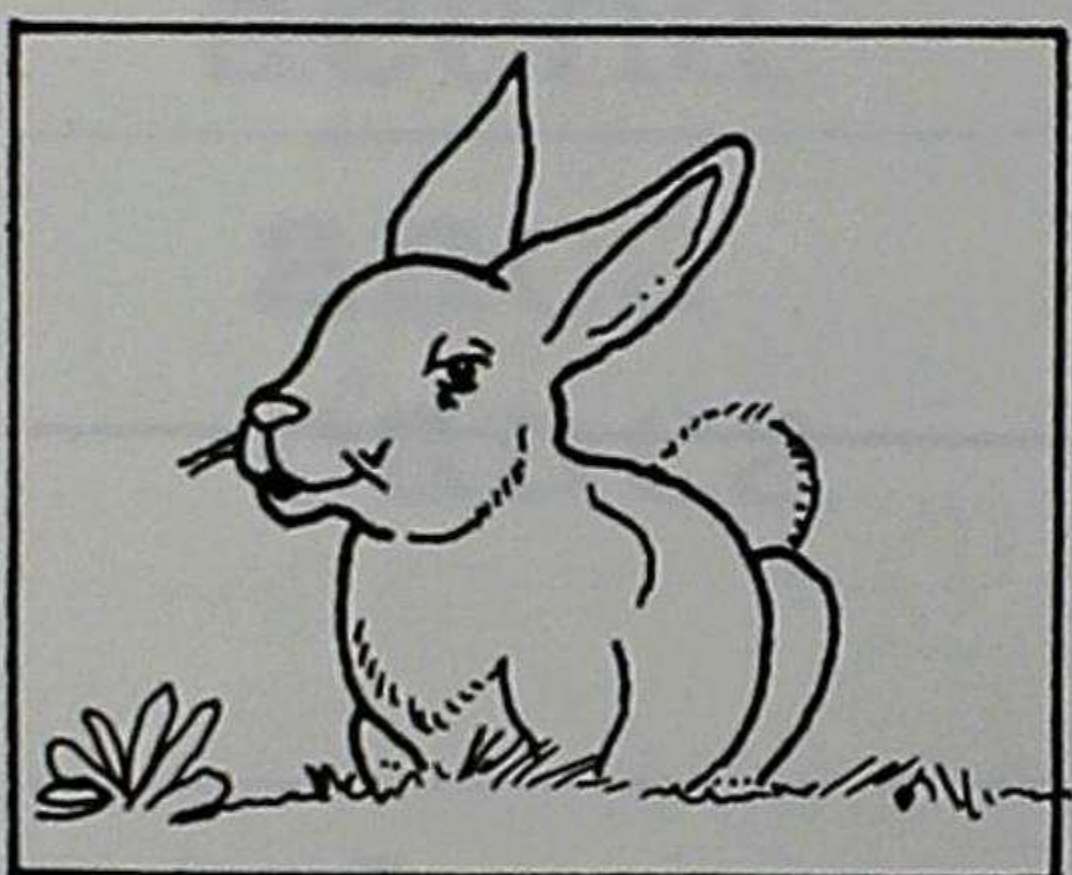

cunu

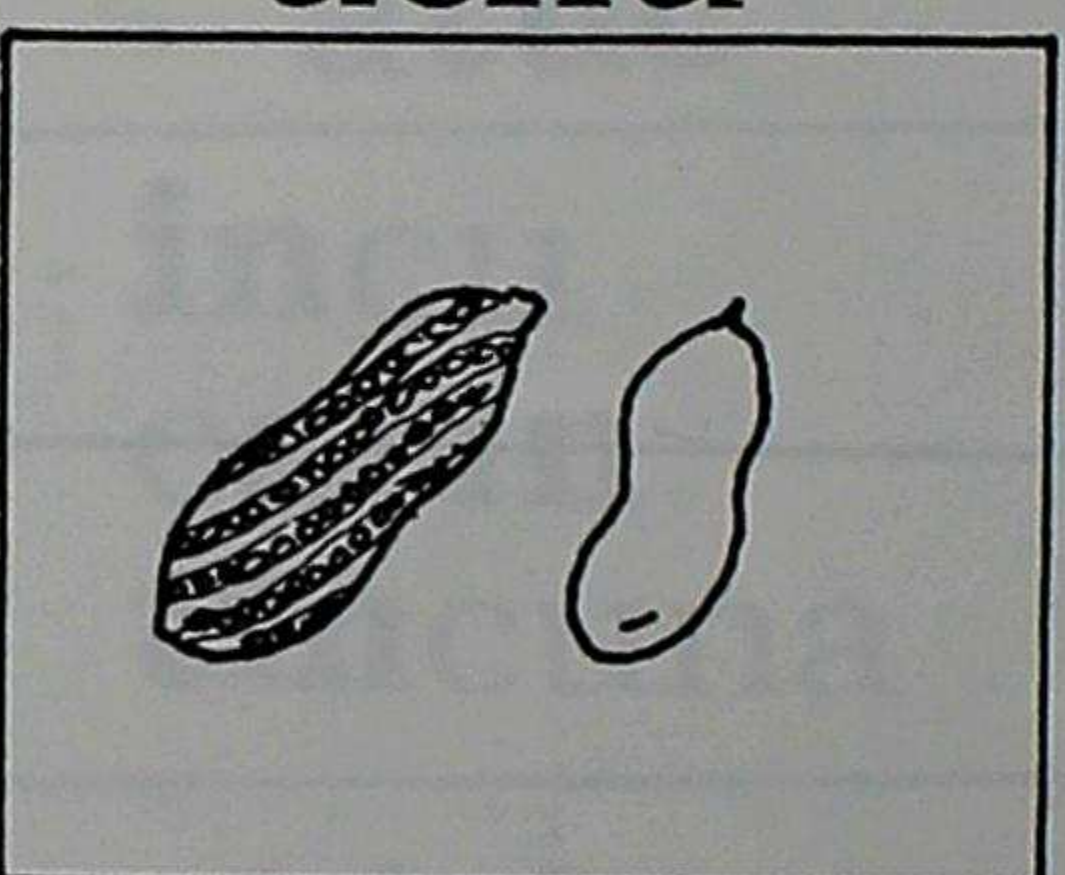

inchic

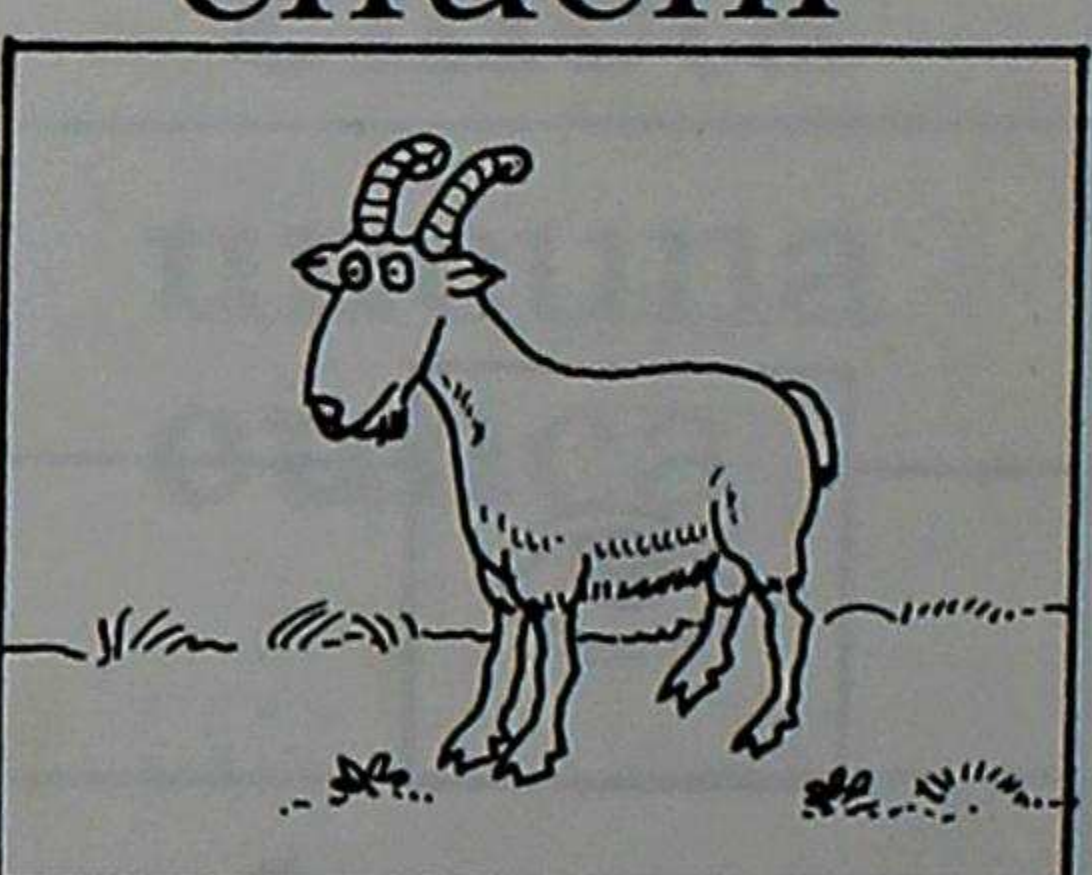

incu

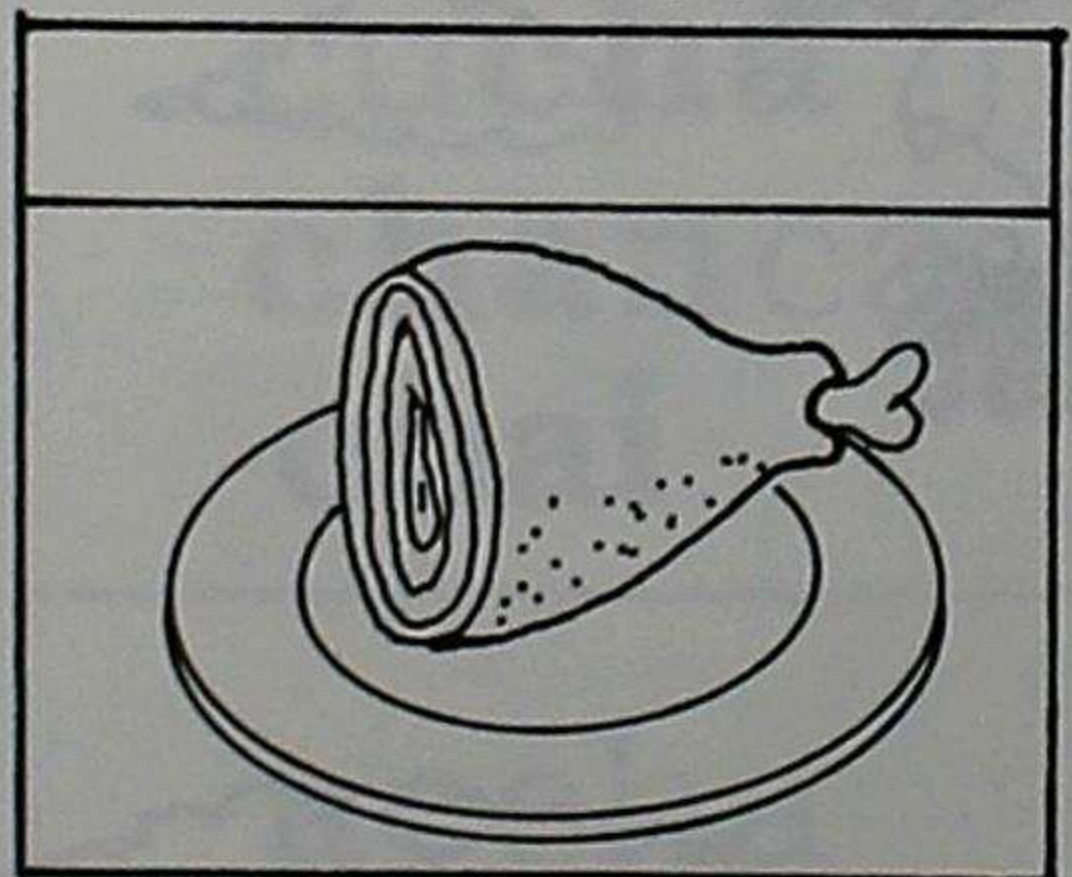

aicha

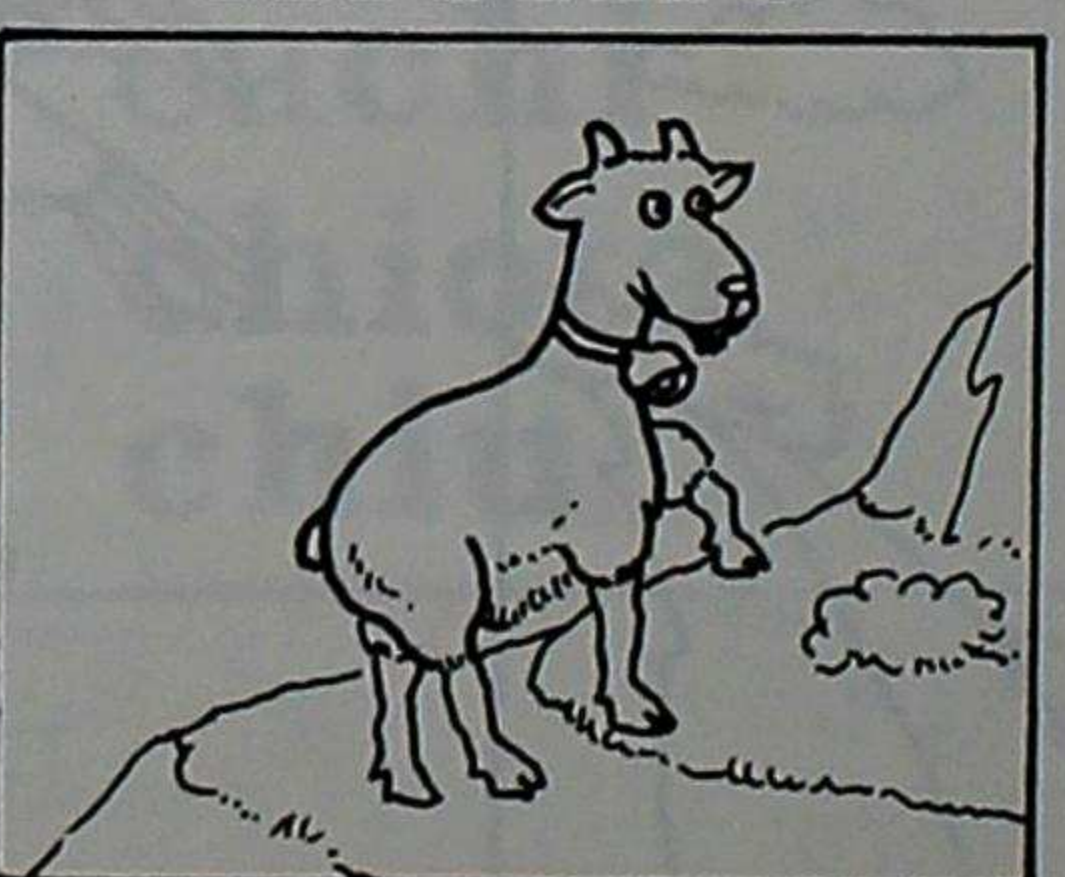

chita



cui

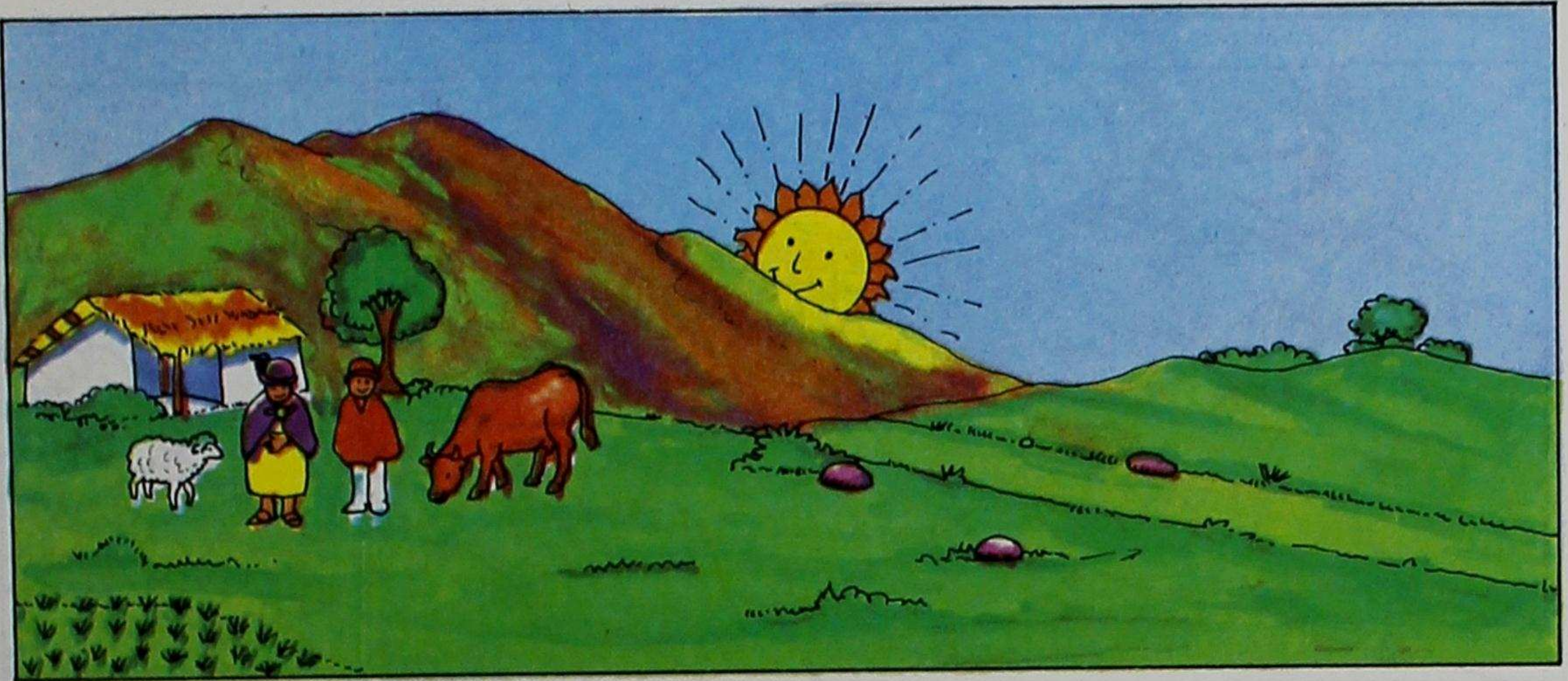
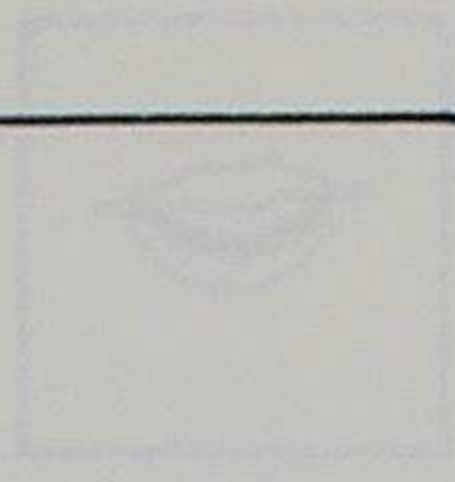
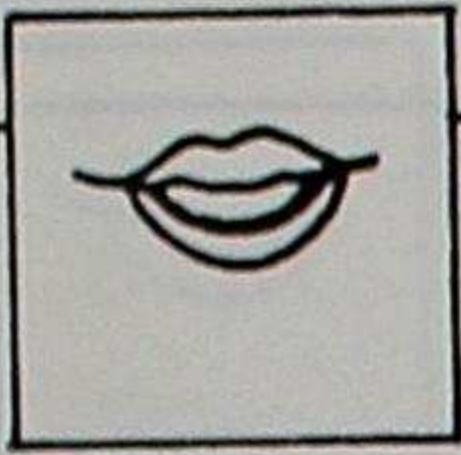

## Inti taita

Inti taitaca tucuicunata cunuchin.  
Tucuicunata achicta cun.

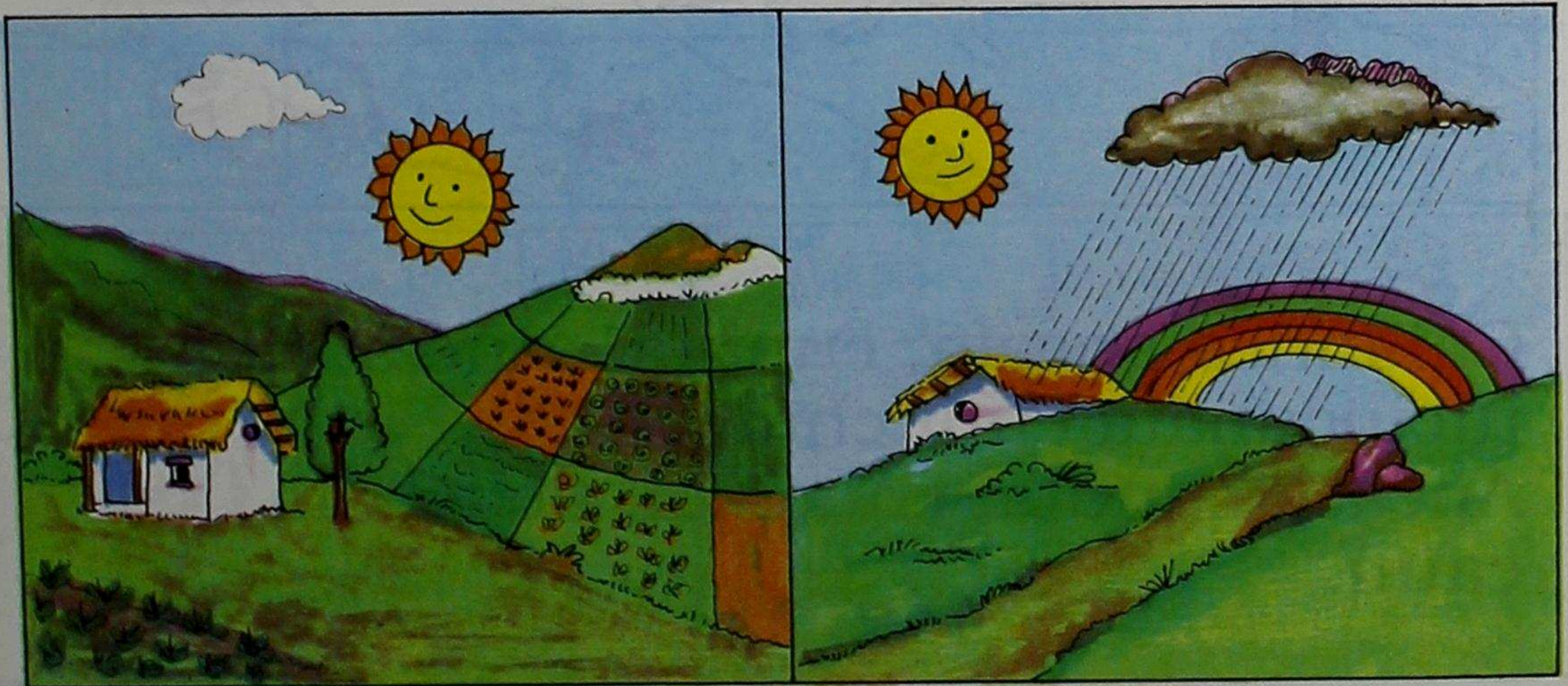
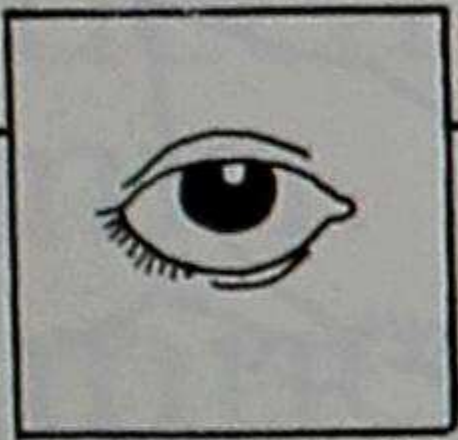

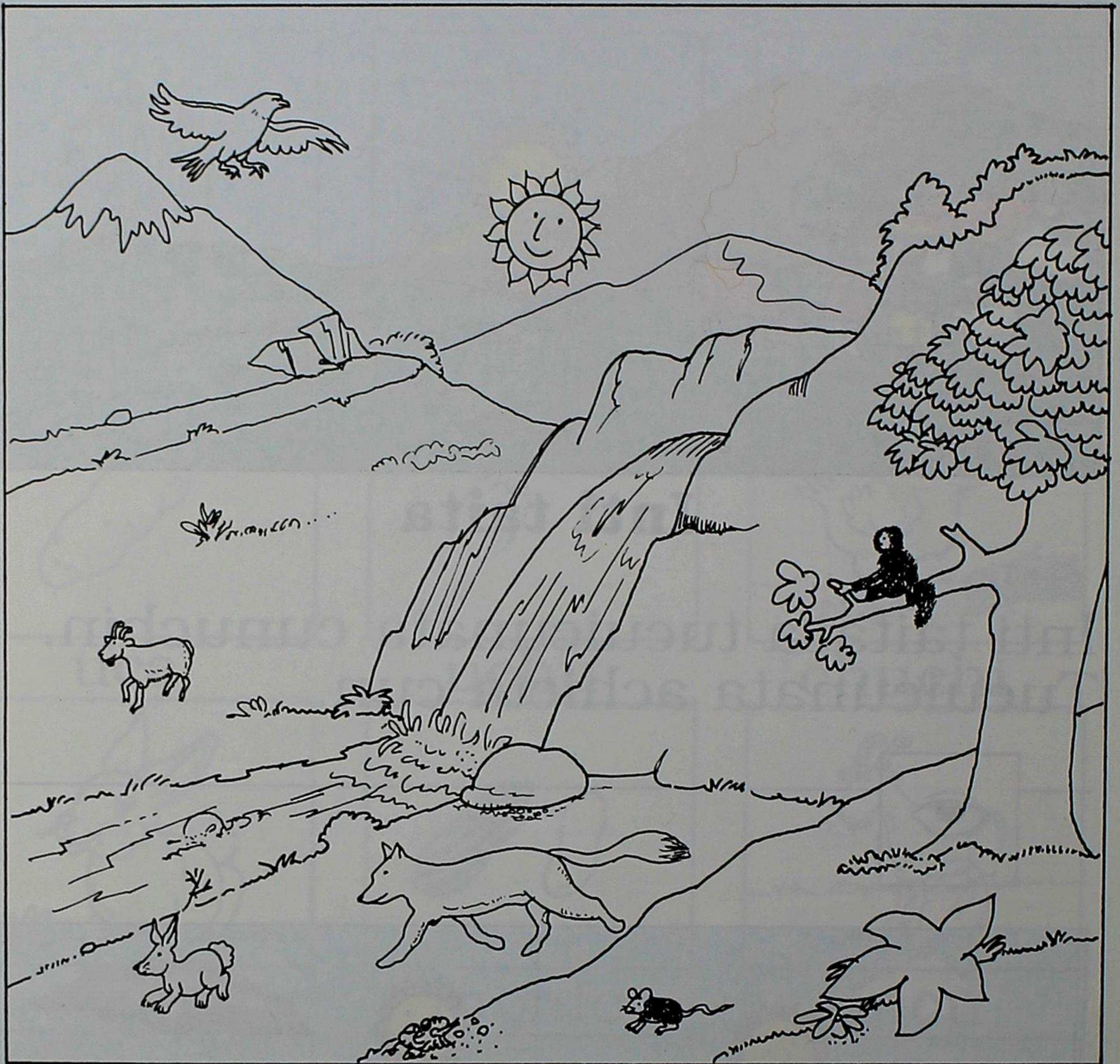
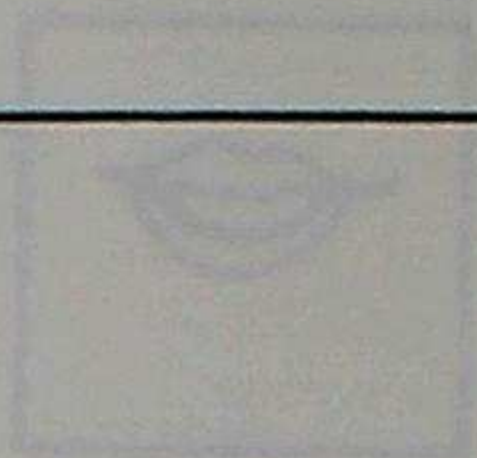
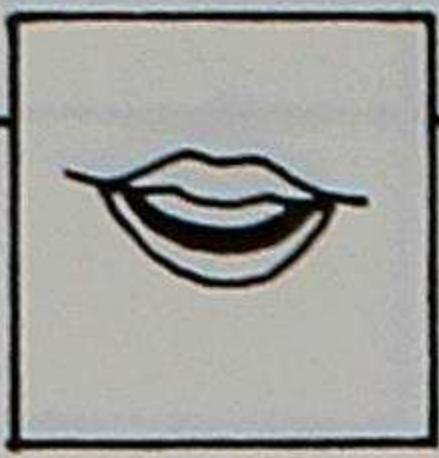

Cai intica ancata, cunuta, atucta, titita  
tucuicunata cunuchin.  
Ancaca cunuta, chuchita, ucuchata  
catin.

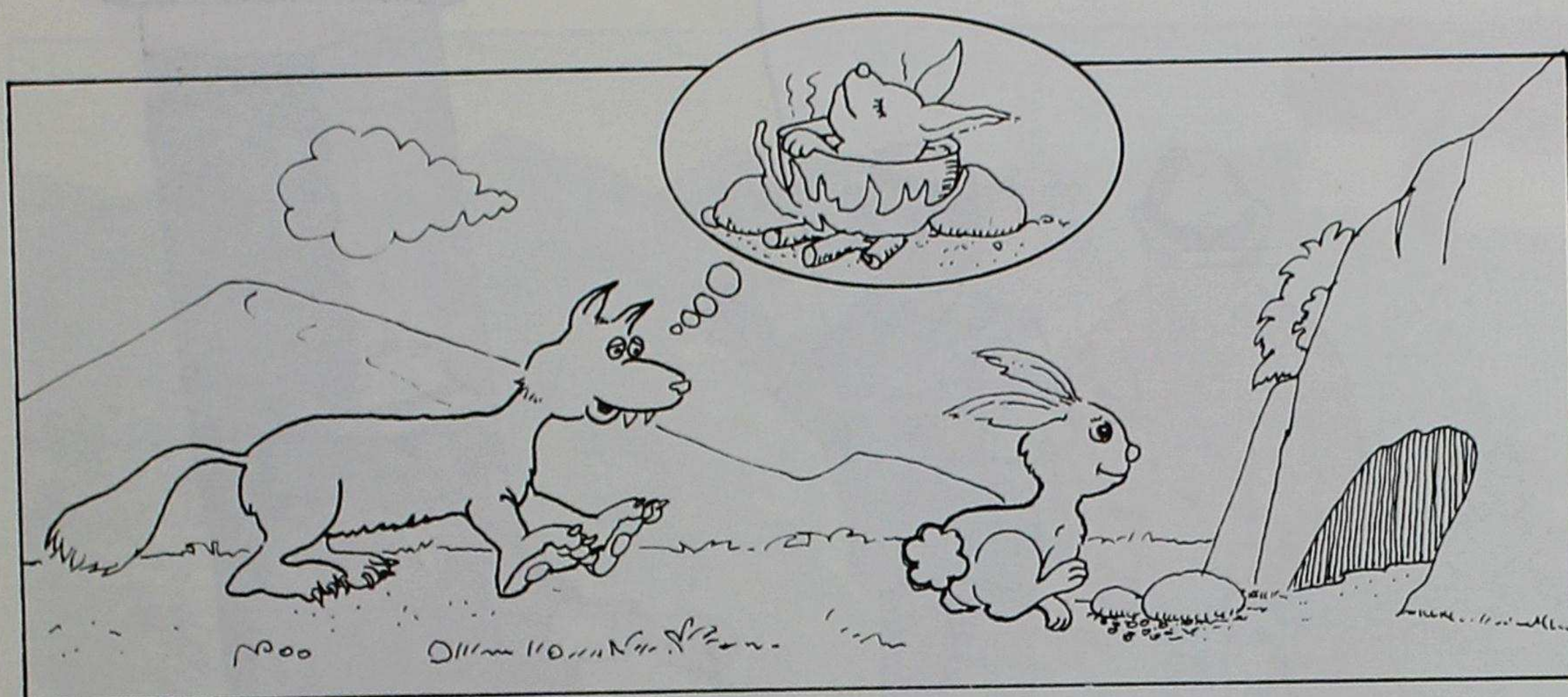
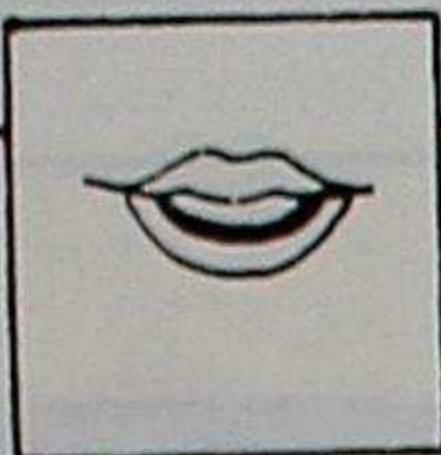

## Atuc cununtin

Atucca cunuta catin.

Cai atucca chai cunuta nin.

Atucca cunutaca utca, utca  
canin.

Cunuca utca ucuta nin.

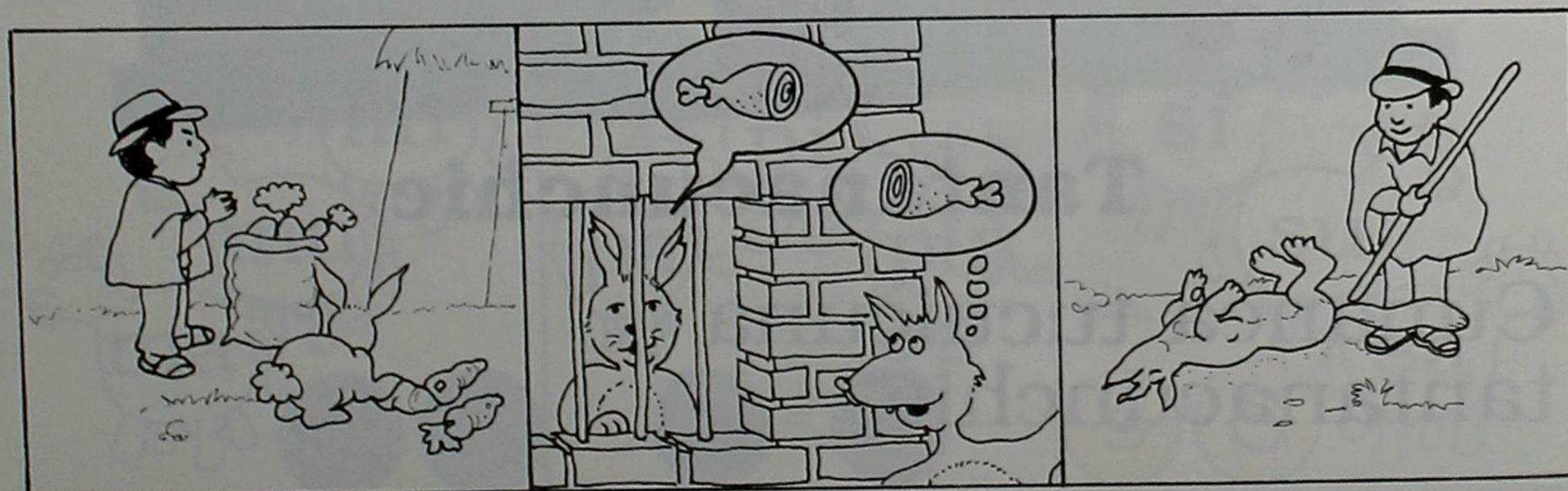
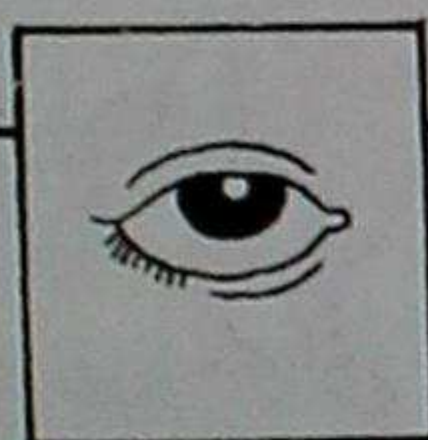

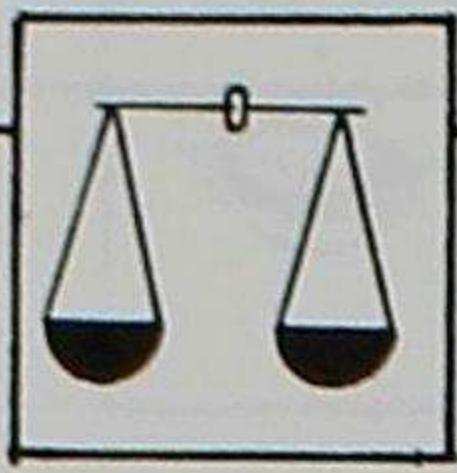

## Tantanacunchic

Cunanca tucuicuna  
tantanacunchic.

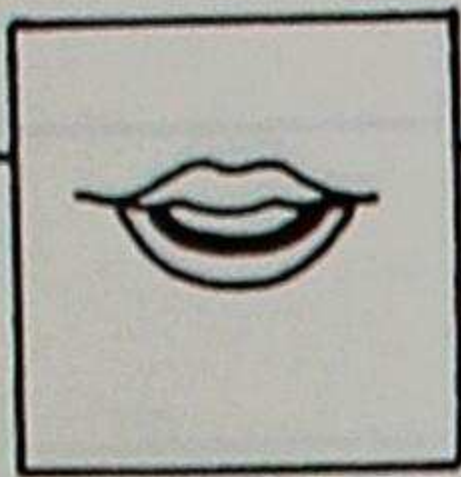

Mamaca papa sisata pitinmi.

mamaca  
mama  
ma ma  
ma

papa  
pa pa  
pa

sisata  
sisa  
si sa  
si

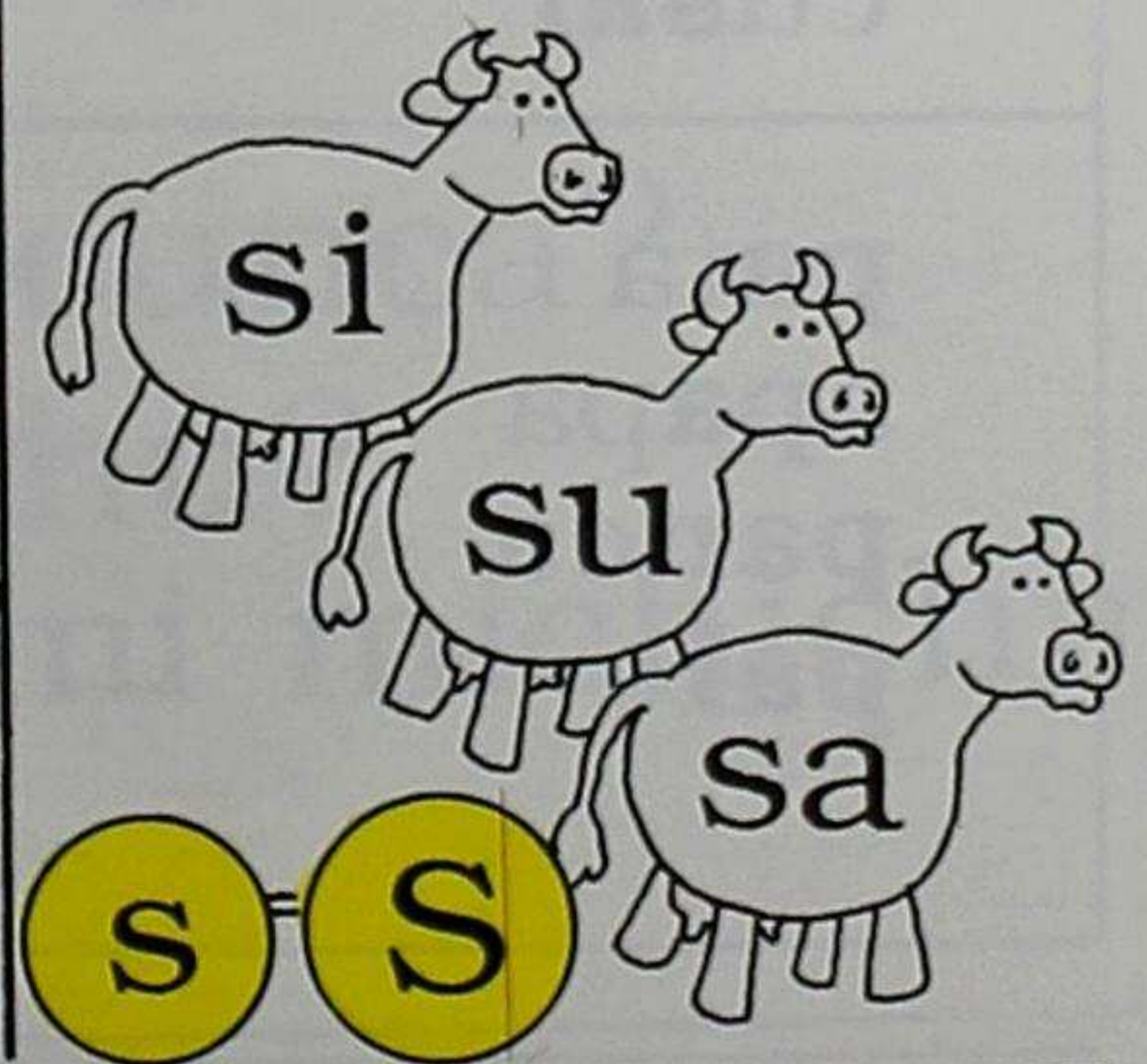
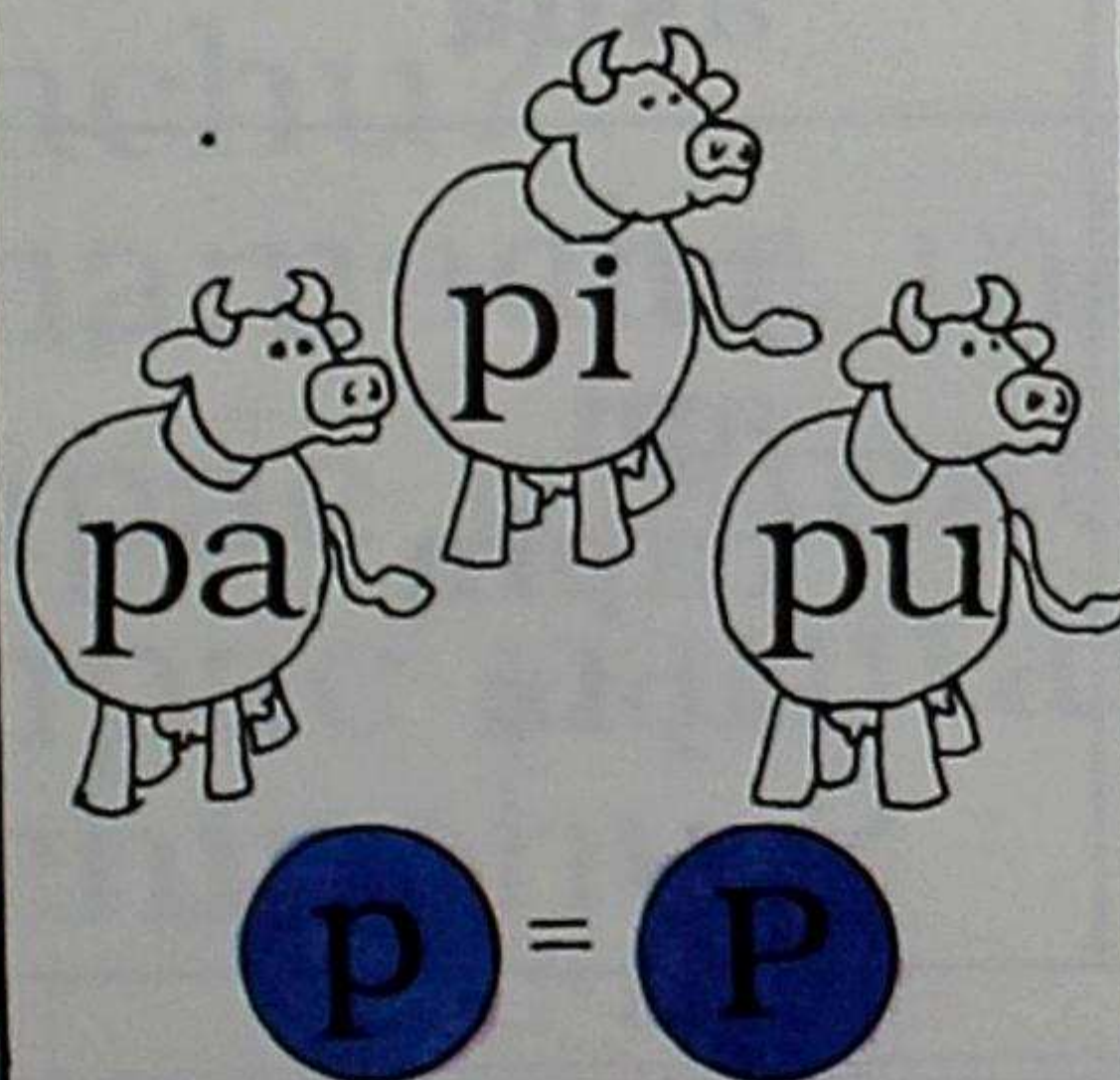
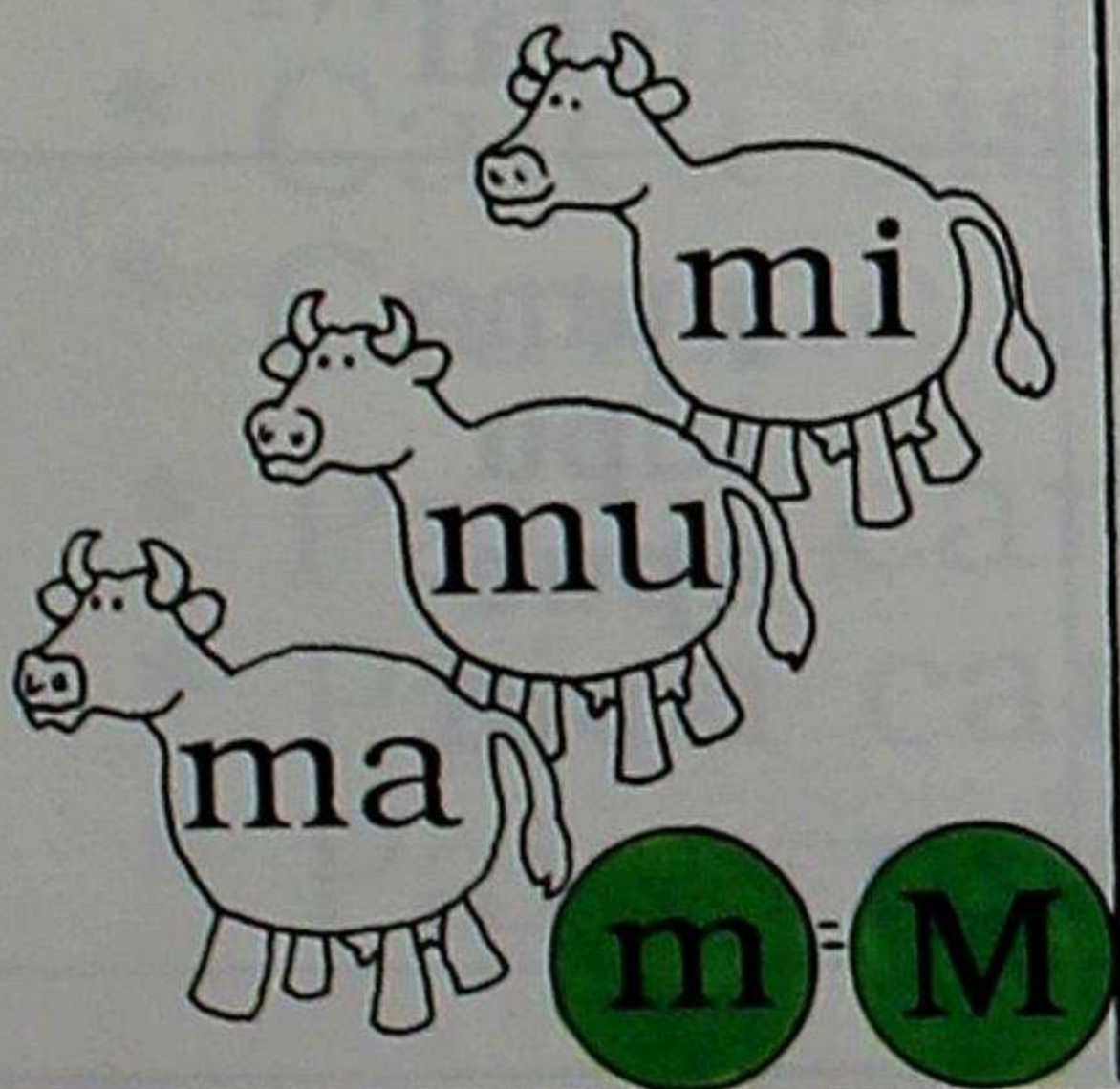



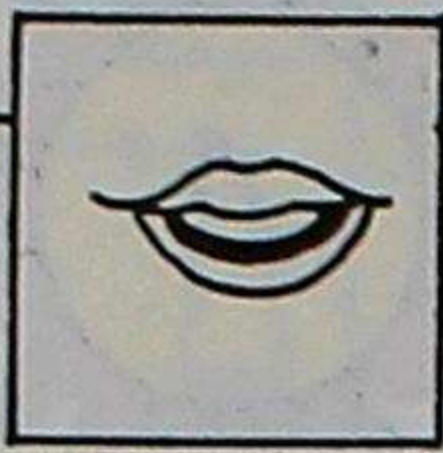

**mati**

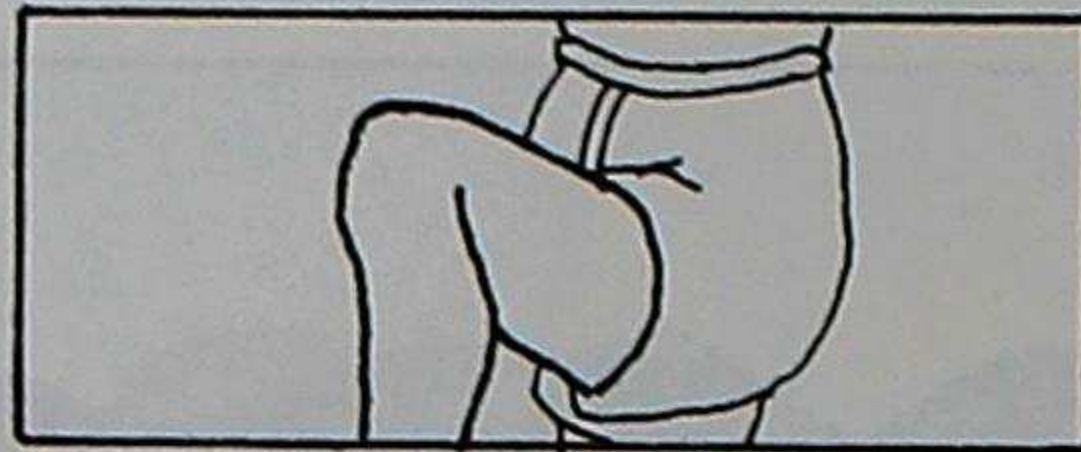

**mucu**

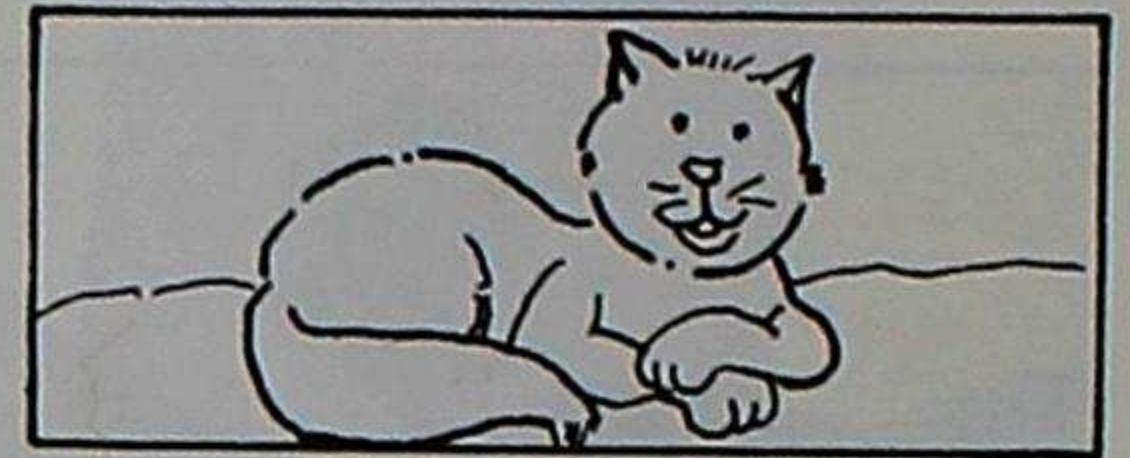

**misi**

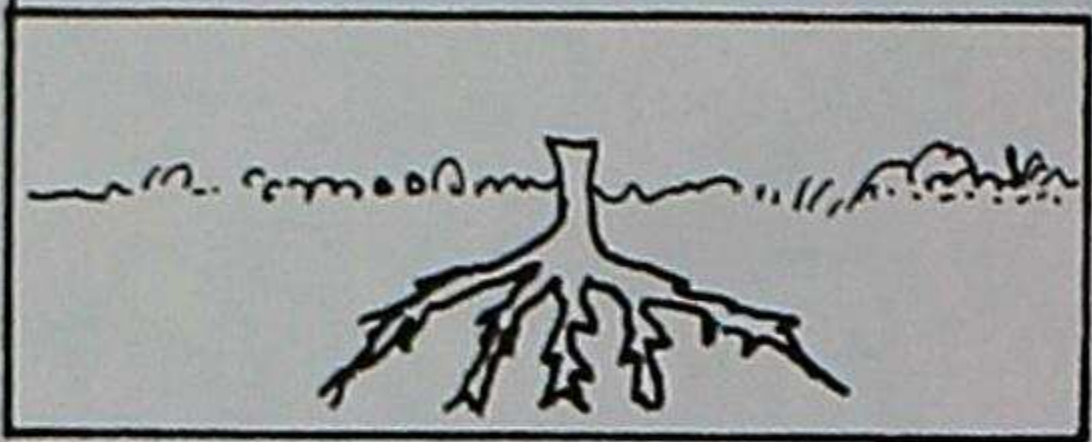

**sapi**

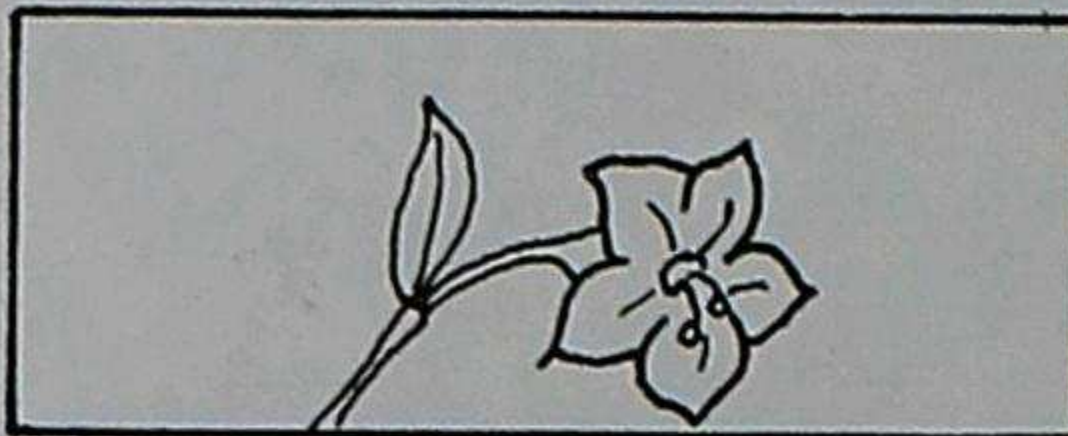

**sisu**



**supai**

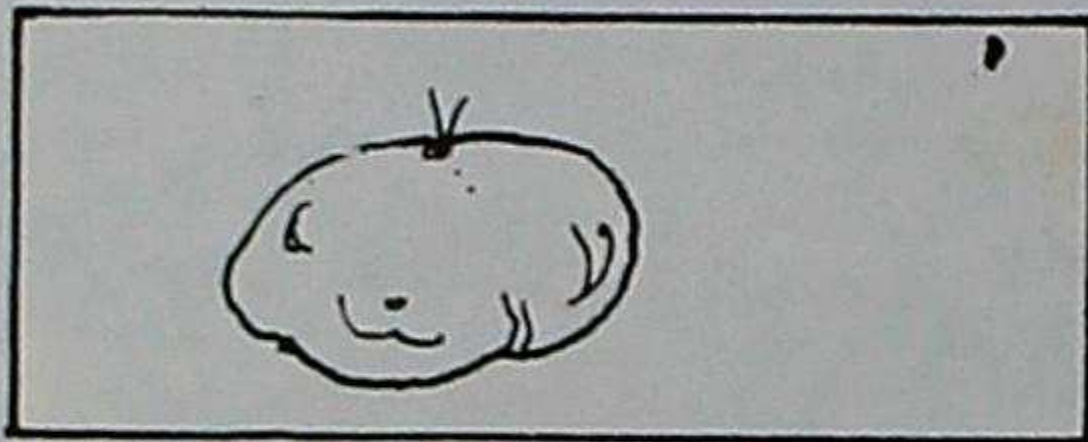

**papa**

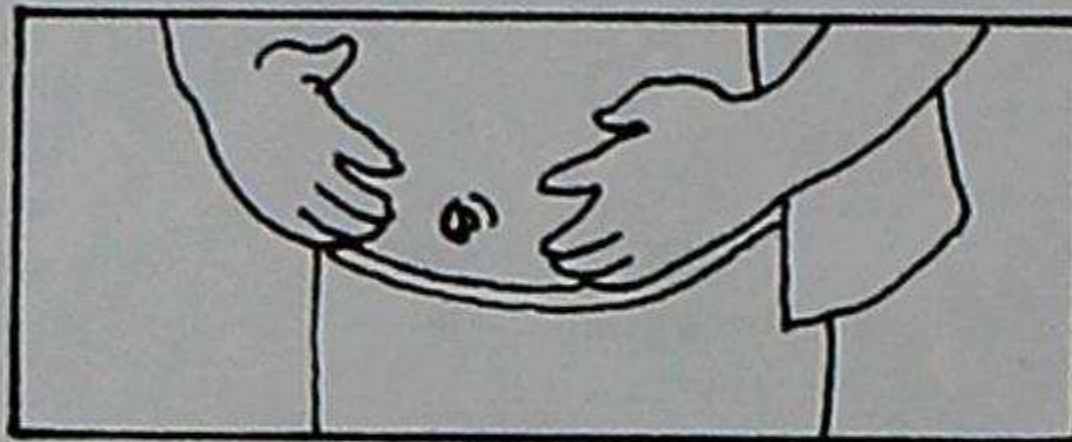

**pupu**

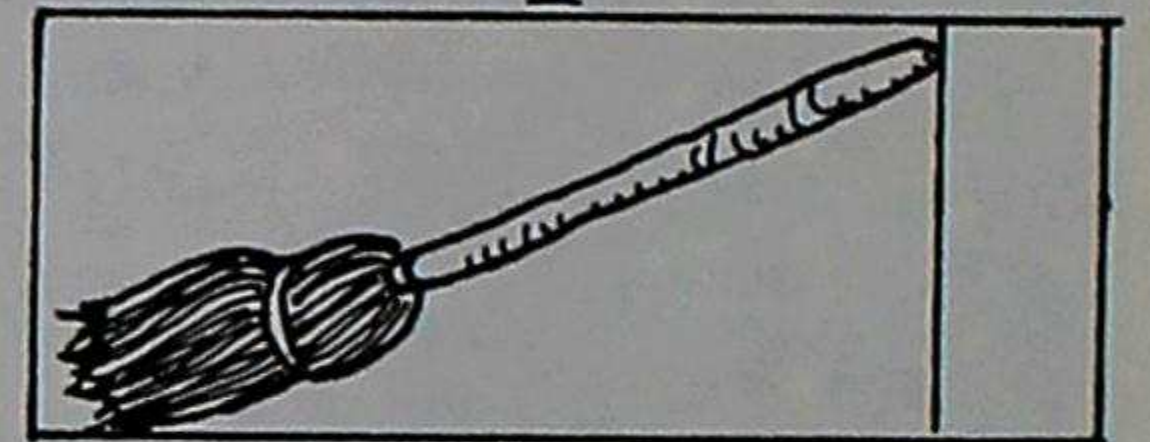

**pichana**

<p><b>mapa</b>  <b>puma</b>  <b>manca</b>  <b>mauca</b></p>	<p><b>mica</b>  <b>tumi</b>  <b>minca</b>  <b>tamia</b></p>	<p><b>muti</b>  <b>umutu</b>  <b>muspa</b>  <b>samai</b></p>
<p><b>sacha</b>  <b>cusa</b>  <b>sancu</b>  <b>cusai</b></p>	<p><b>suchu</b>    <b>sucta</b>  <b>asua</b></p>	<p><b>sisu</b>  <b>asina</b>  <b>sinca</b>  <b>usiai</b></p>
<p><b>pata</b>  <b>apapa</b>  <b>panca</b>  <b>pai</b></p>	<p><b>piti</b>  <b>api</b>  <b>capin</b>  <b>apiu</b></p>	<p><b>puma</b>  <b>tupu</b>  <b>apuc</b>  <b>tapui</b></p>

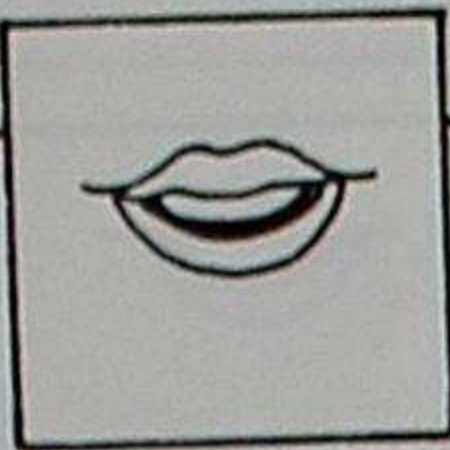

mama

mamami  
mamaman  
mamapac  
mamachu  
mamacha

sisa

sisami  
sisaman  
sisapi  
sisapac  
sisachu  
sisacha

papa

papami  
papaman  
papapi  
papapac  
papacha  
papachu

michina

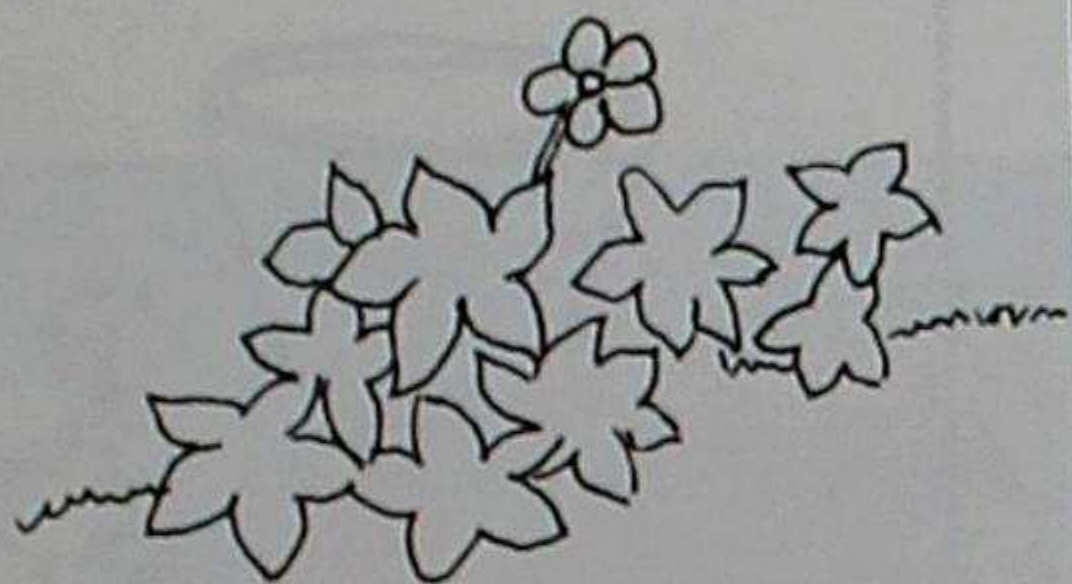

michimuni  
michichini  
michinacha  
michinachu

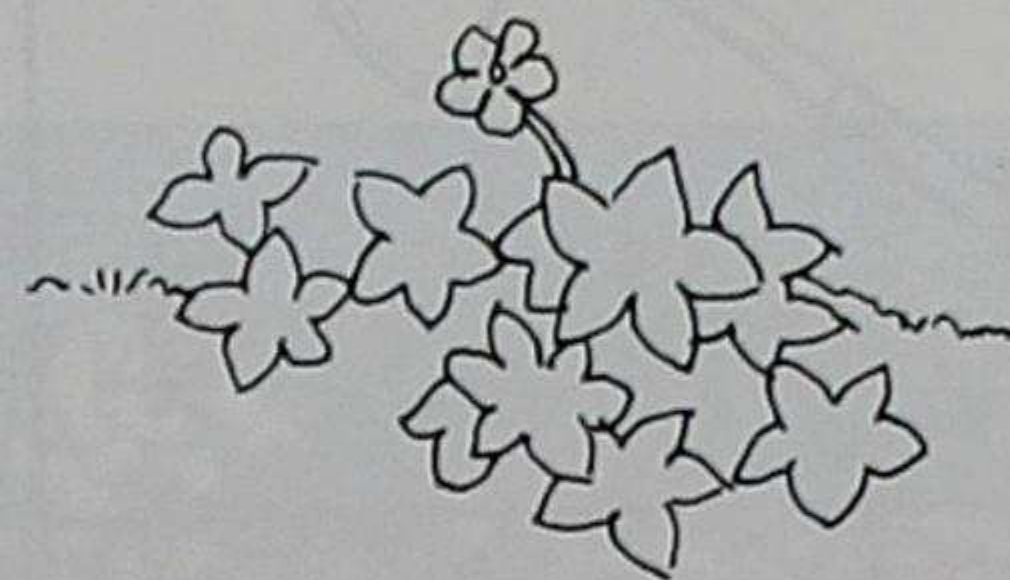

- \* Mamaca mai sumac sisata apacunmi.
- \* Mamaman papa apita apamuni.
- \* Cai sisami sumac can.
- \* Mamapac cai mutita apamuni.
- \* Caica sisachu?
- \* Canpac mamacha micunca?
- \* Paica canpac mamachu?
- \* Paica canpac panitami michichin.
- \* Paica michinchu ?

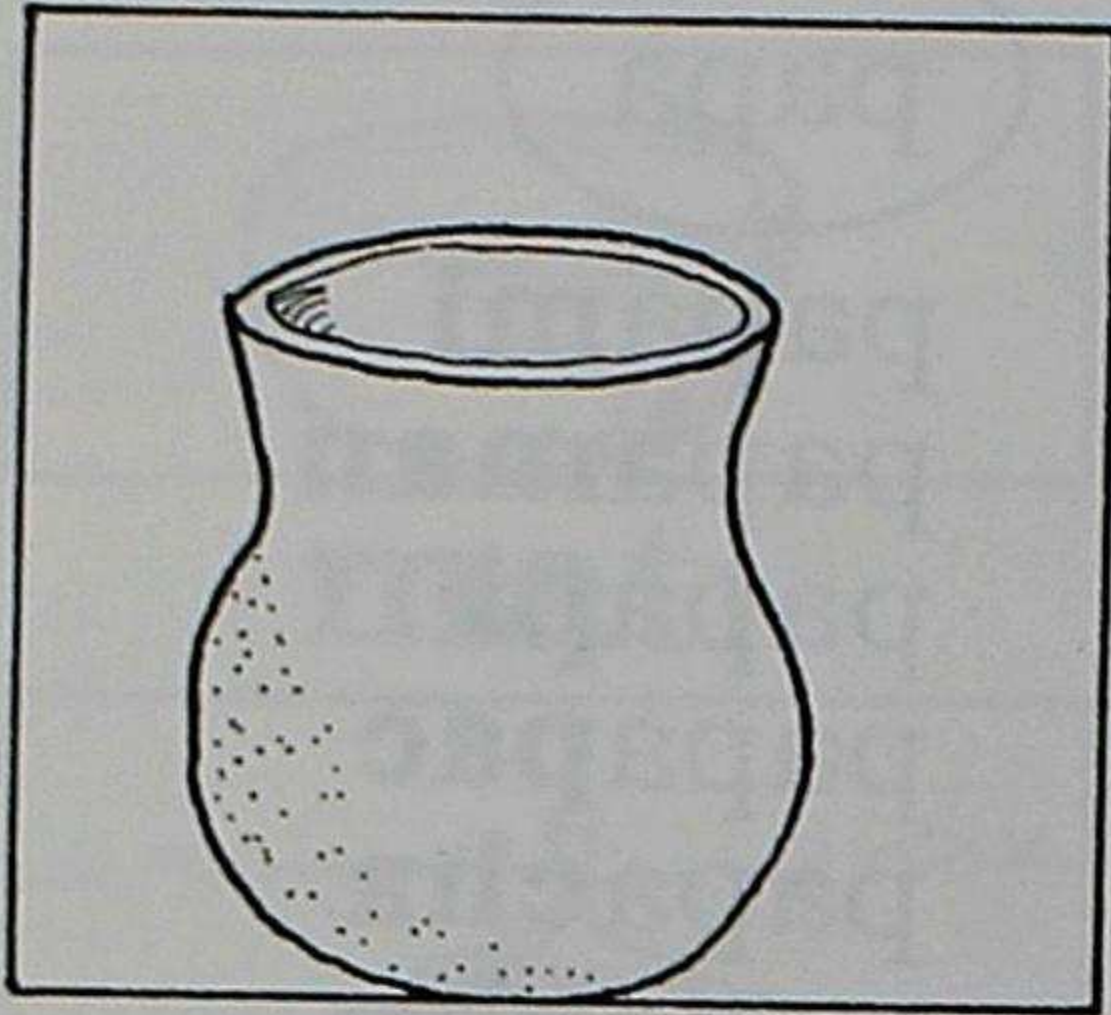
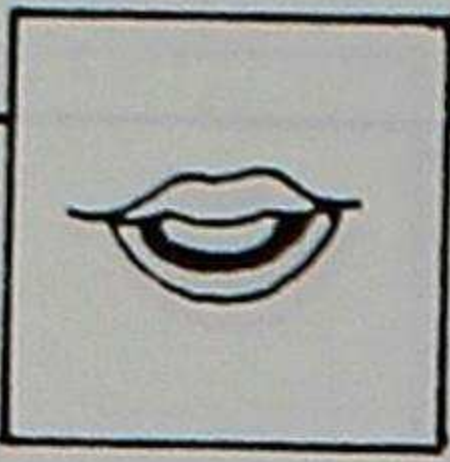

manca

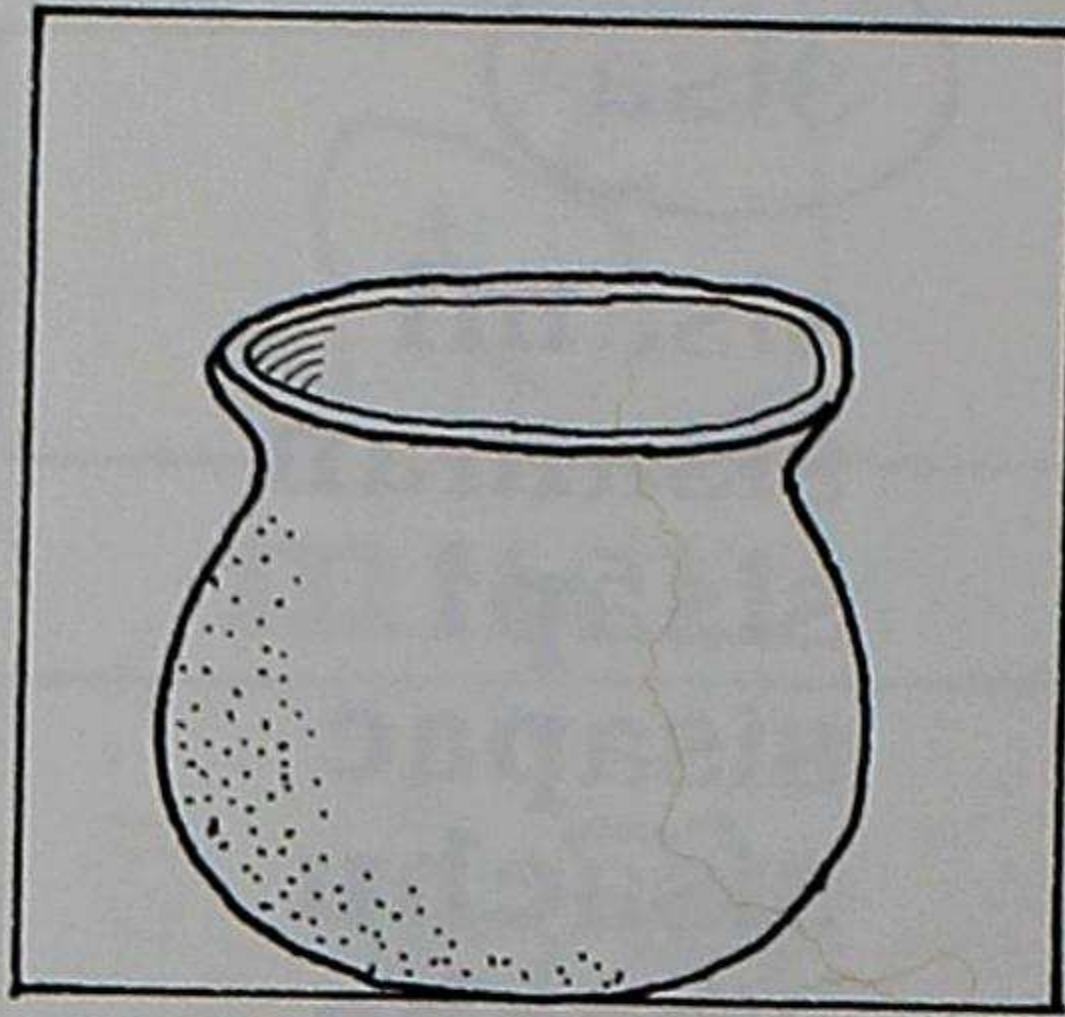

mauma

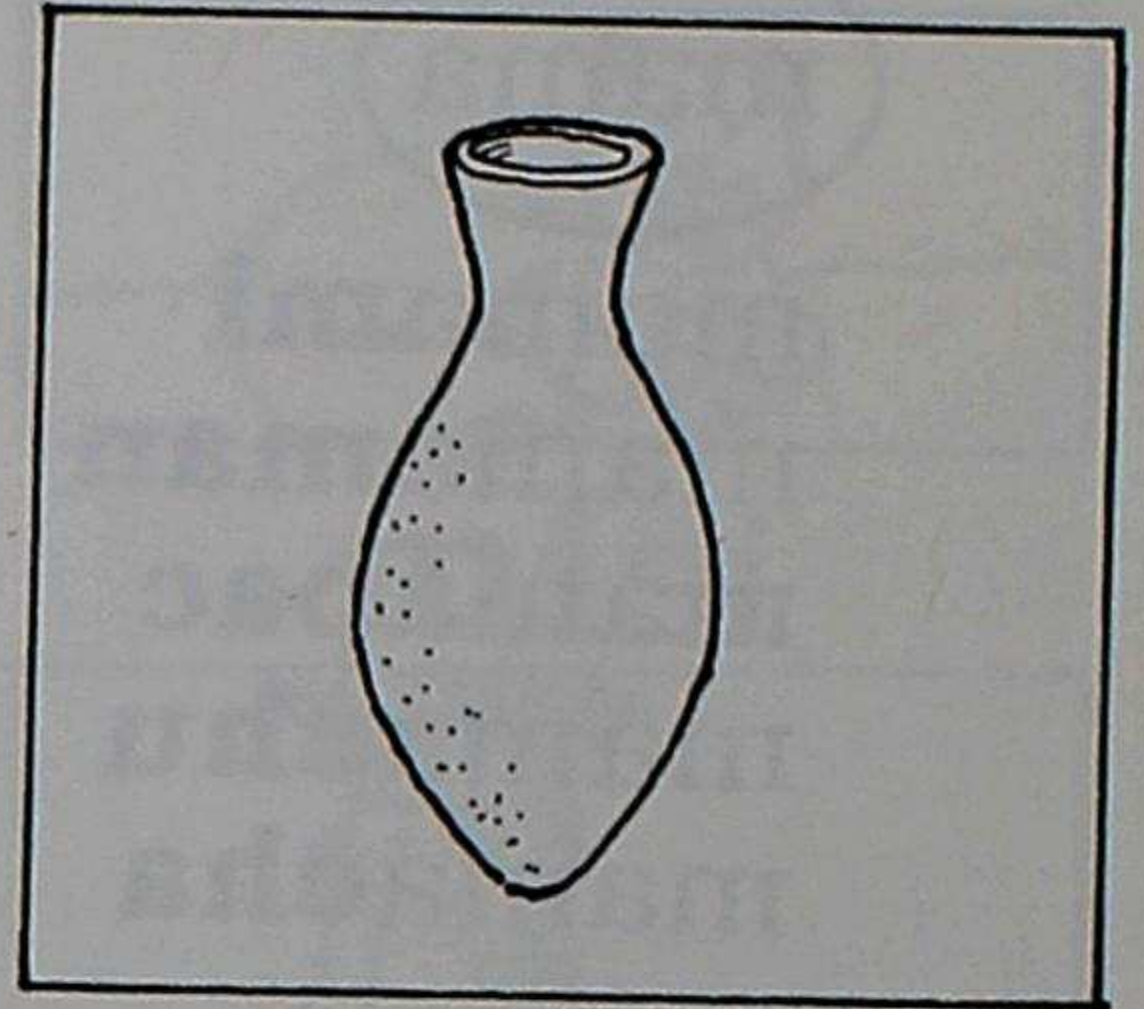

puntu

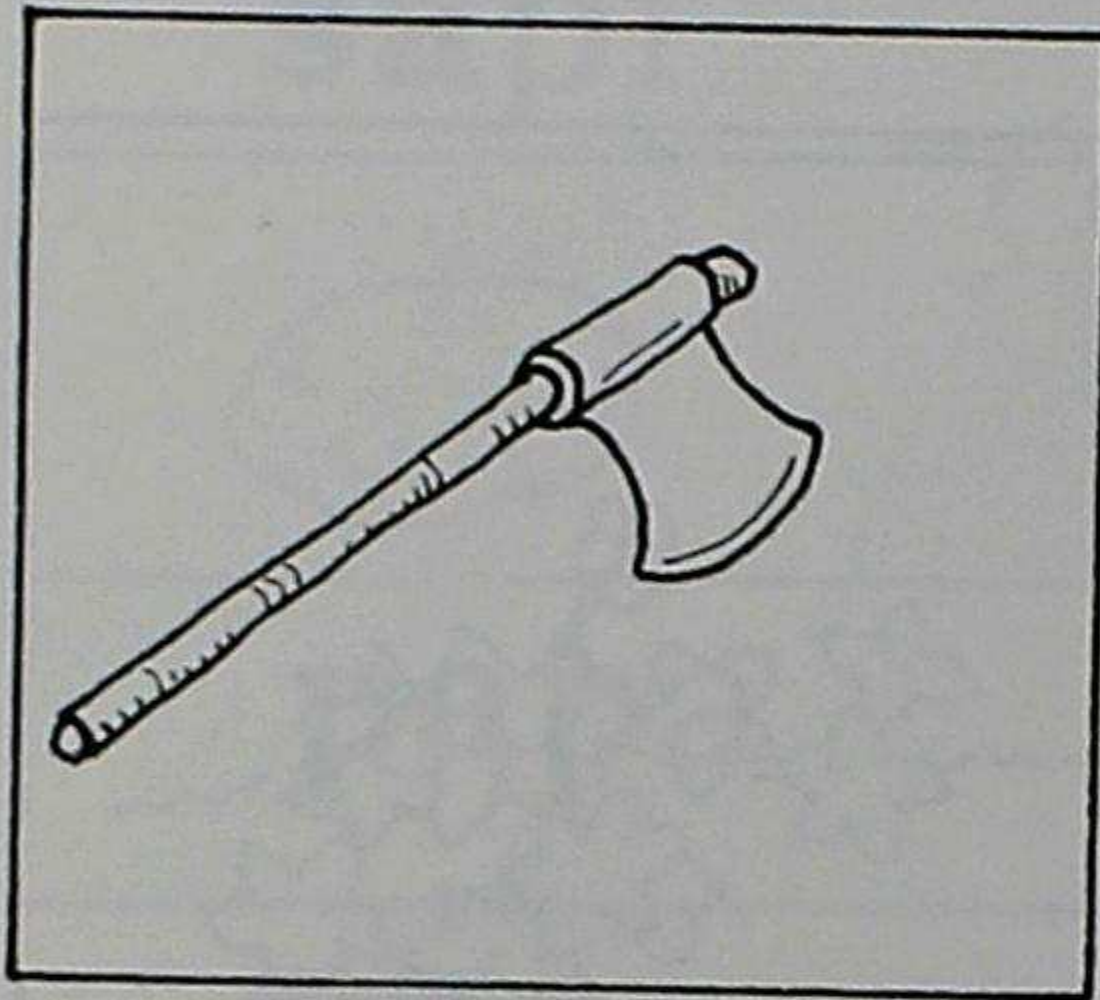

tumi

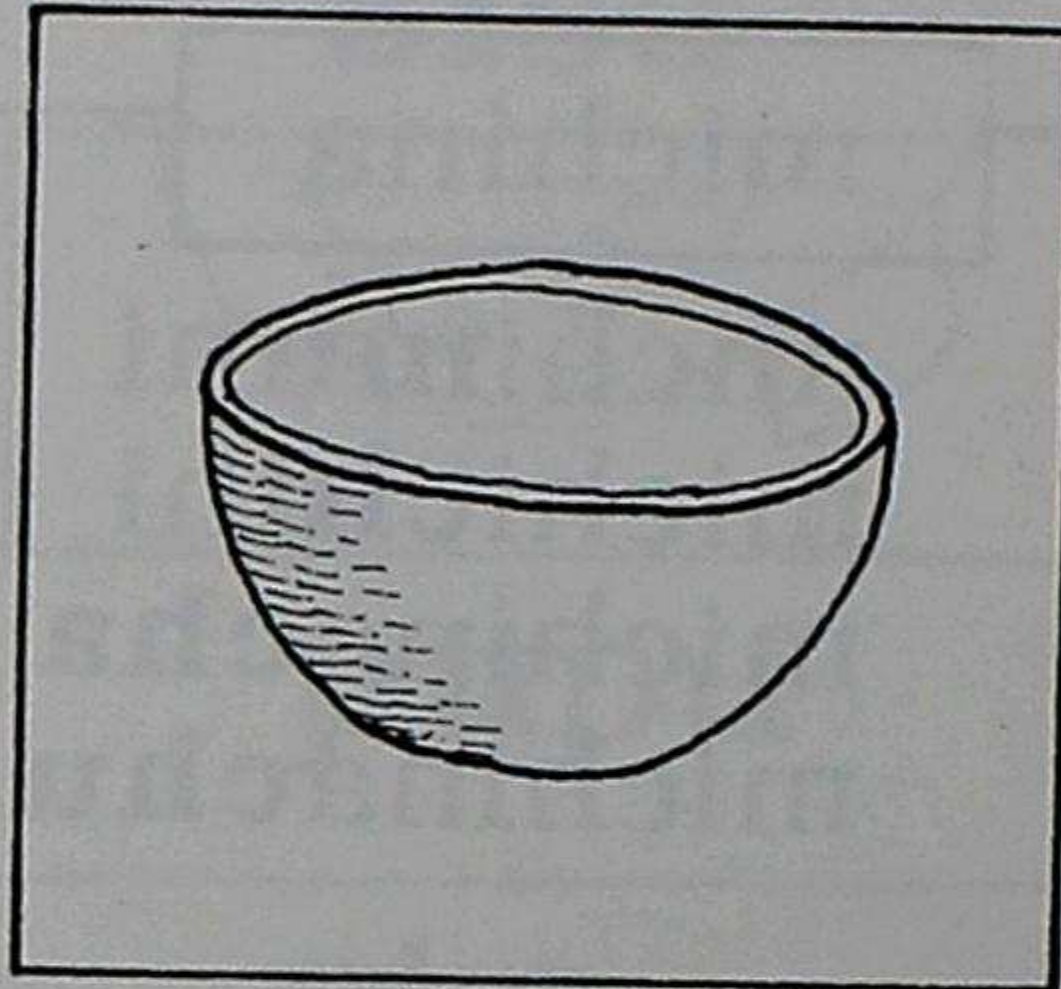

mati

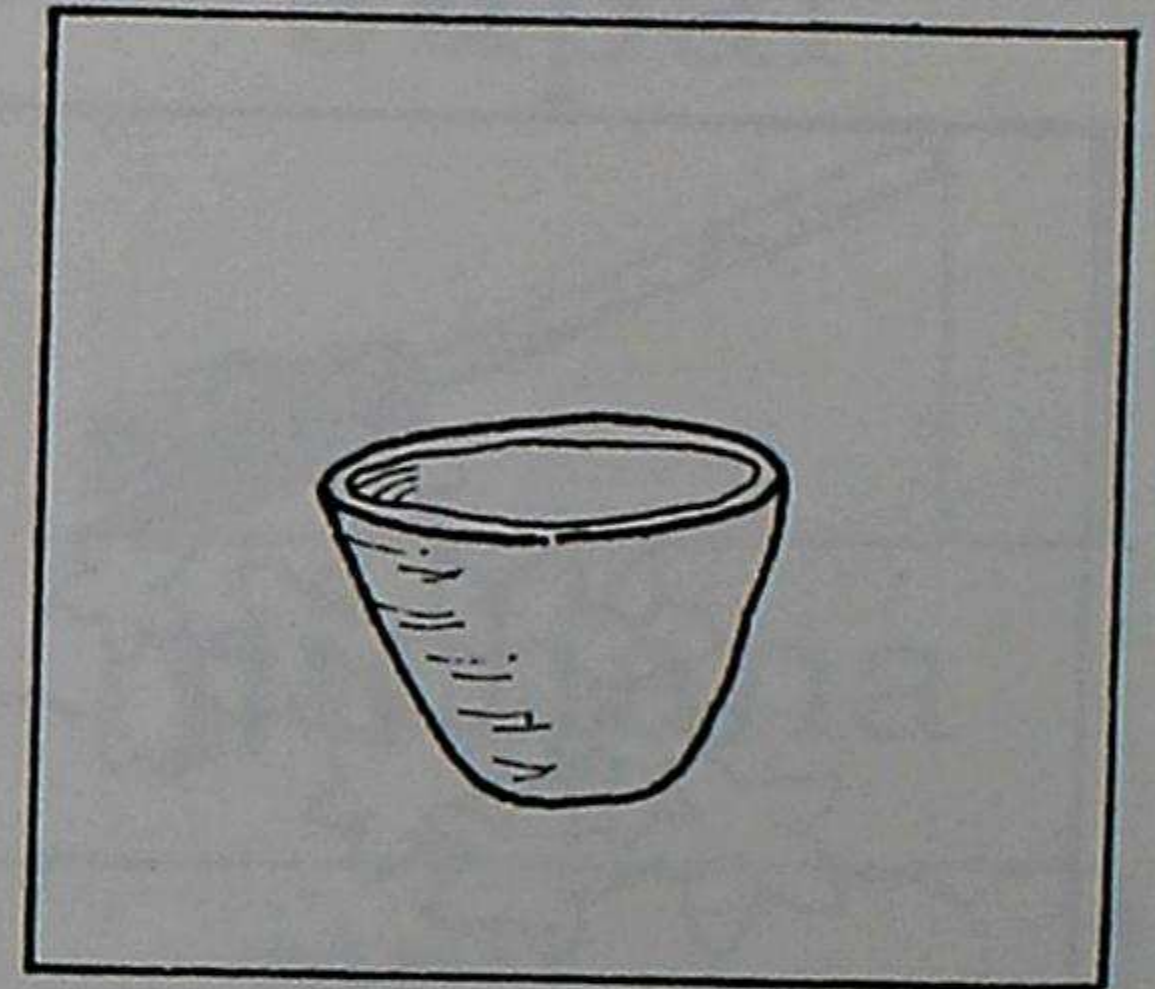

pucu

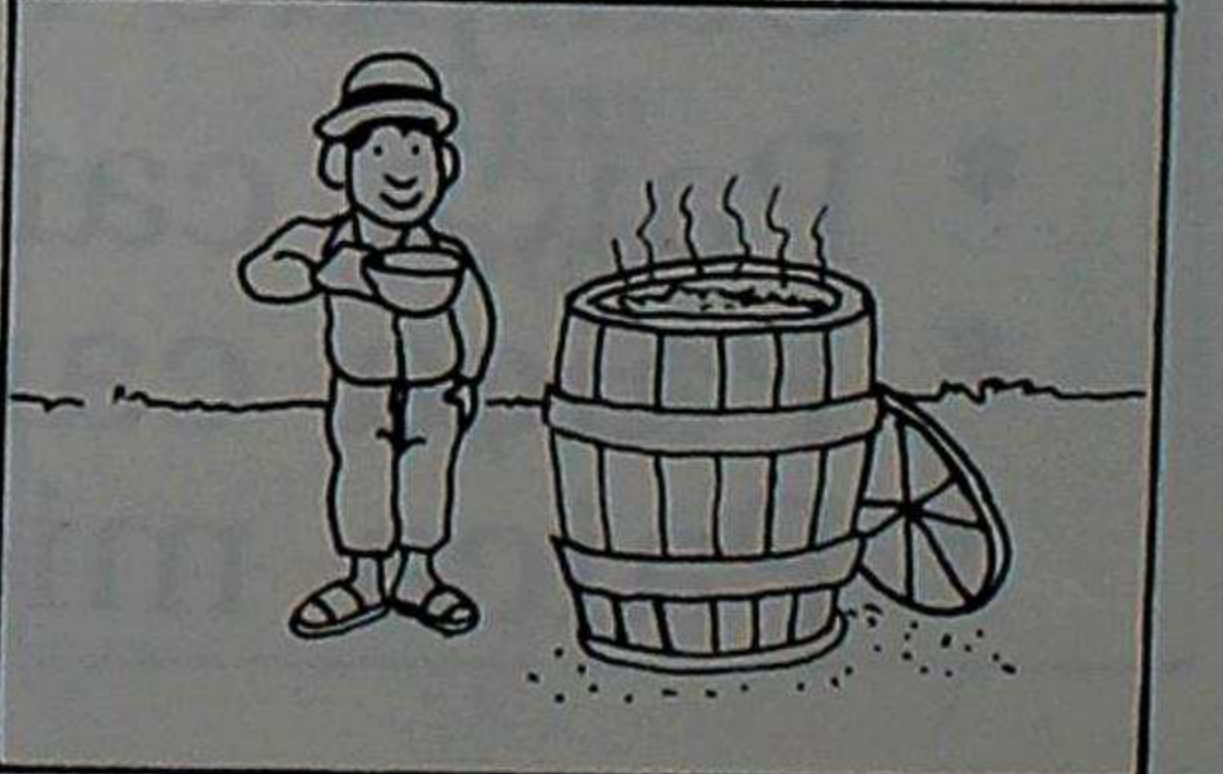
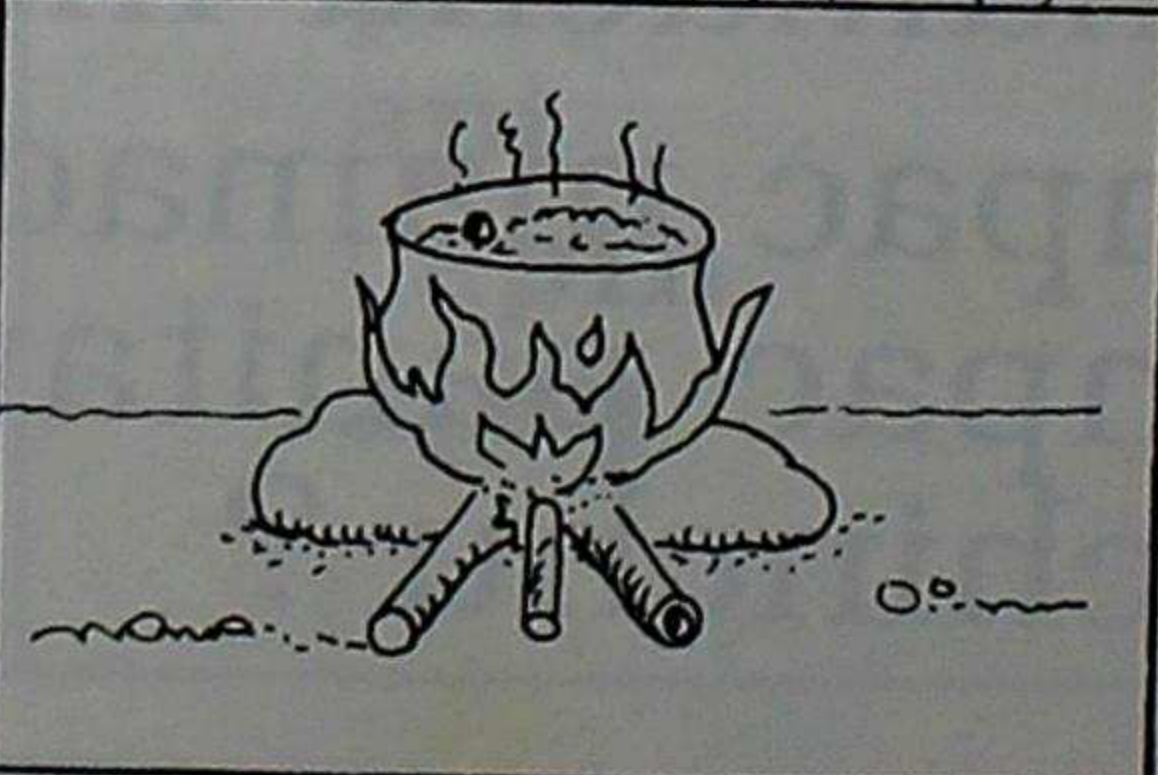
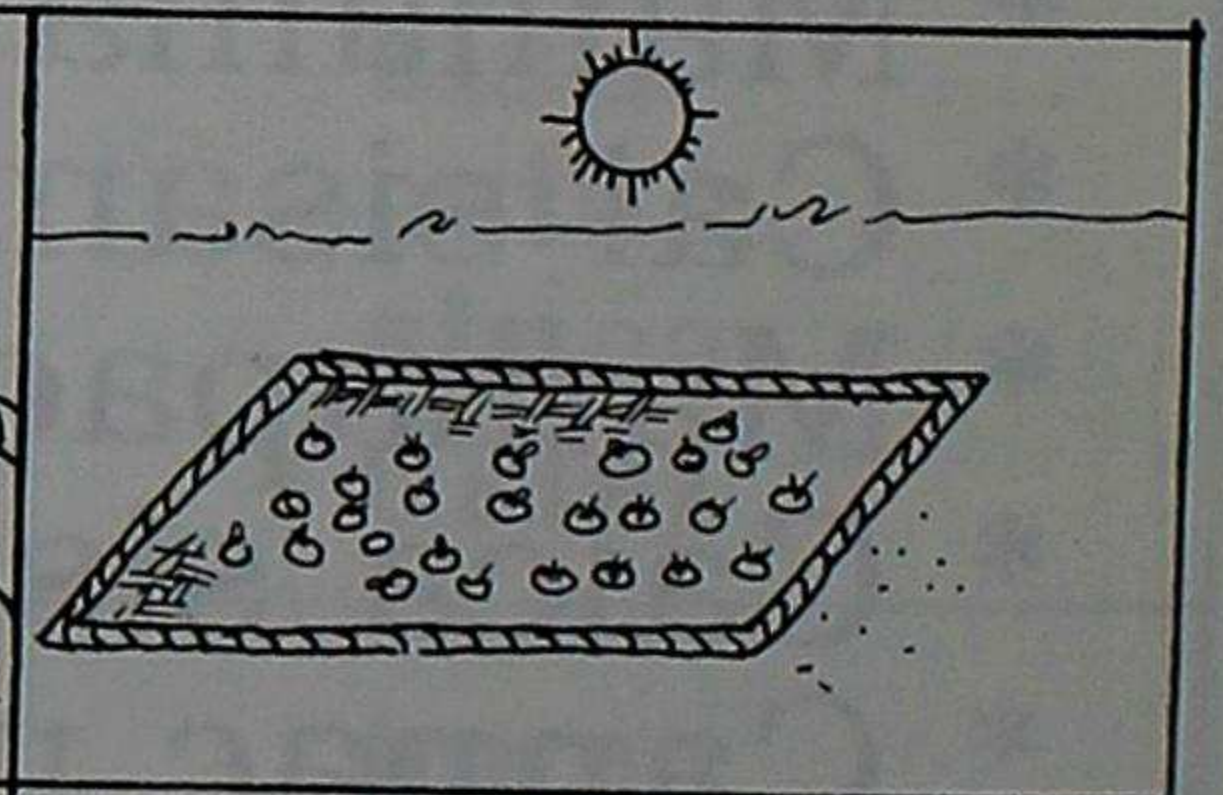
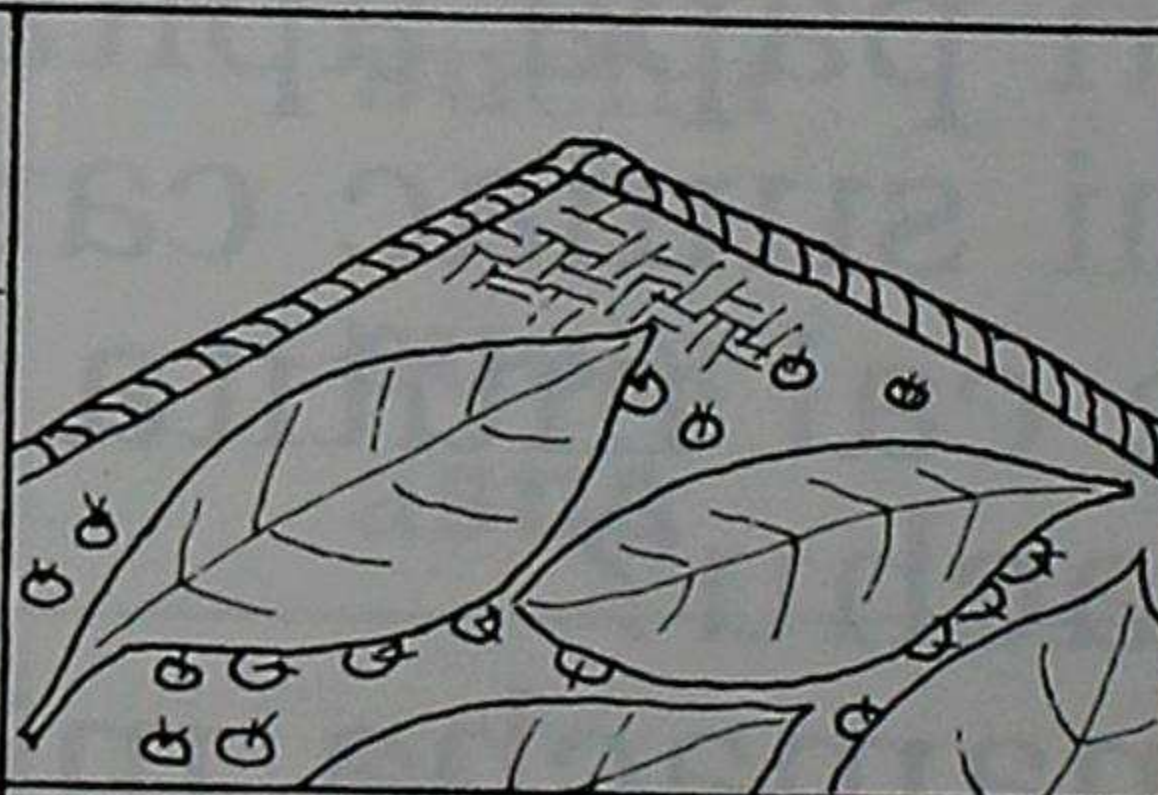
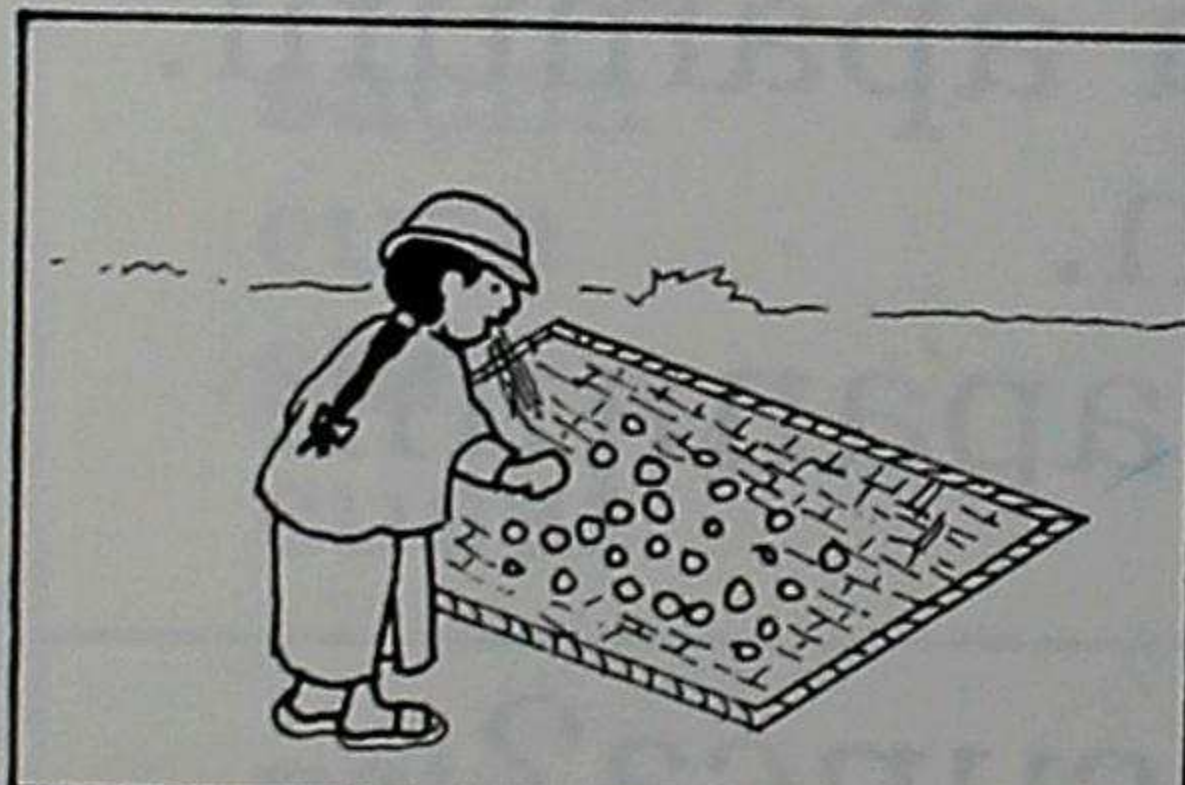
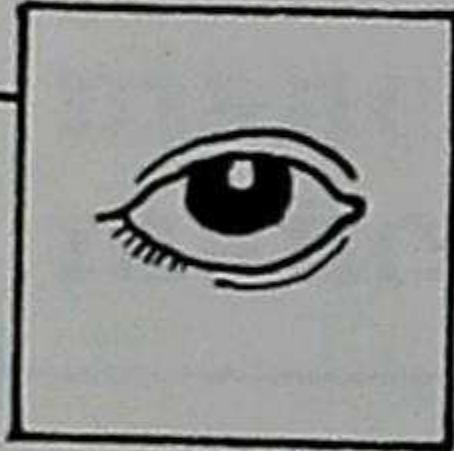

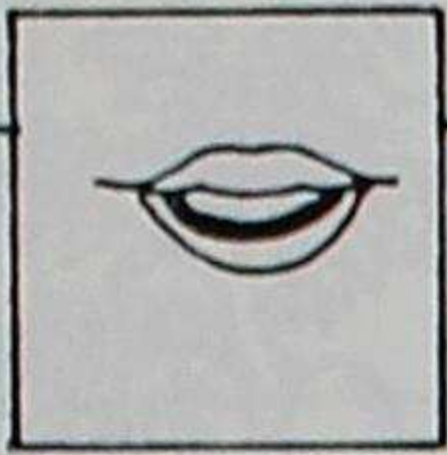

# Ticacunamanta

Inca pachapica mana ticacunataca  
cusancunachu. Cunan pachapica  
ticacunataca cusancunami.  
Cai taitacunaca ticacunataca  
cusana ucuman satinacun.  
Puca ticacunaca catuncapacmi.  
Ticacunaca patacunapacmi can.

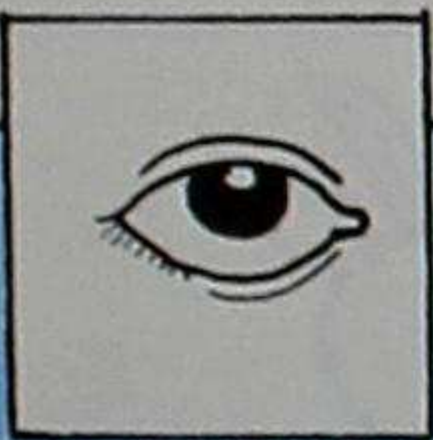

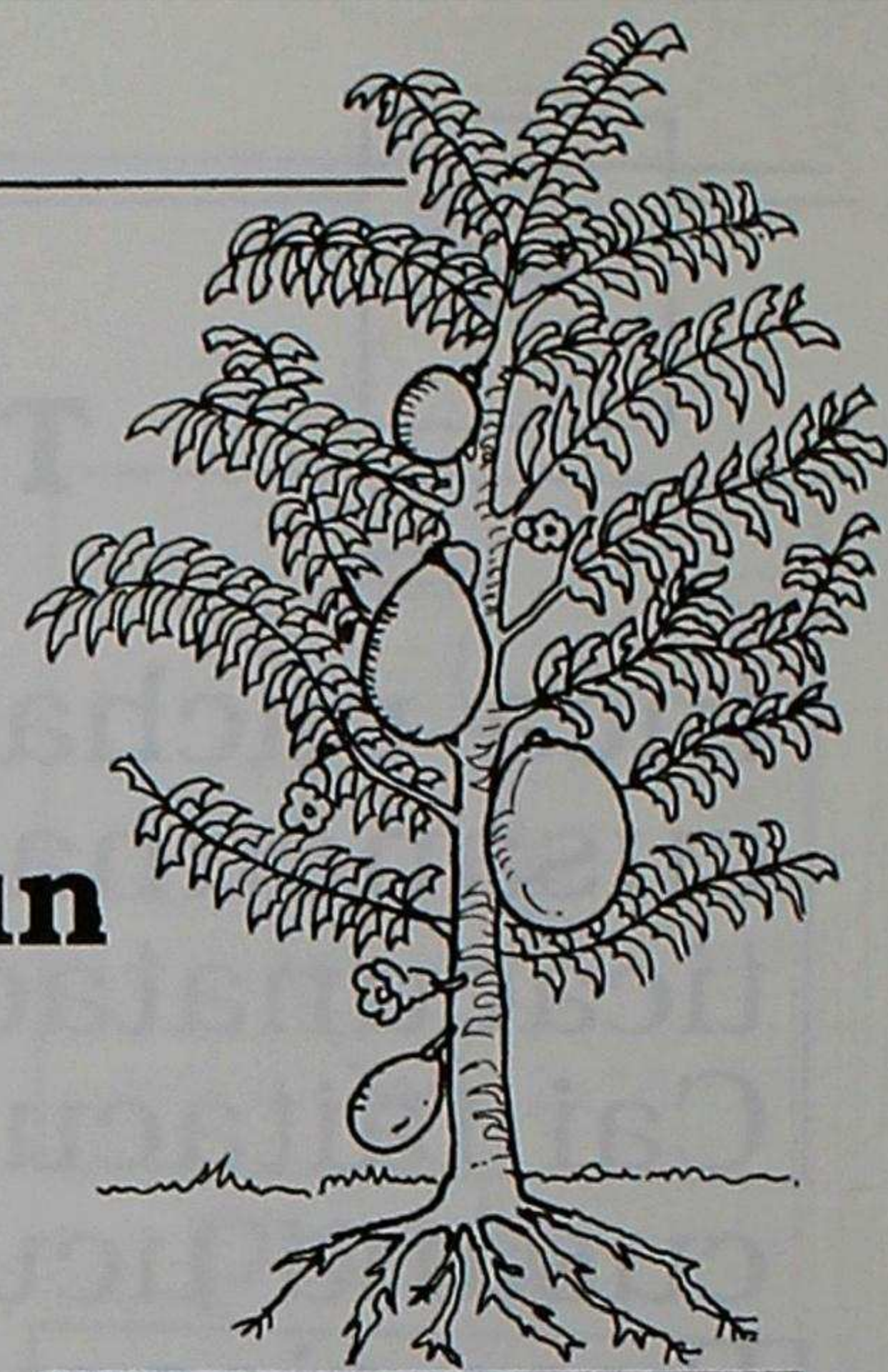
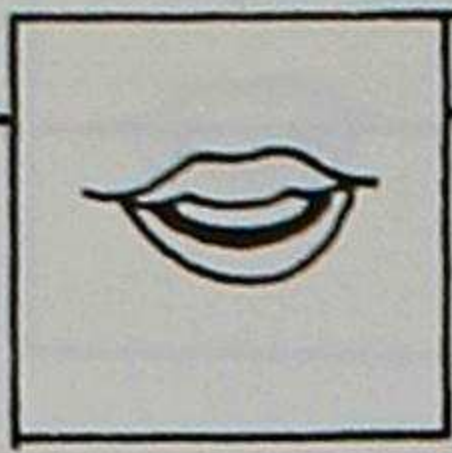

## Caipimi matica pucun

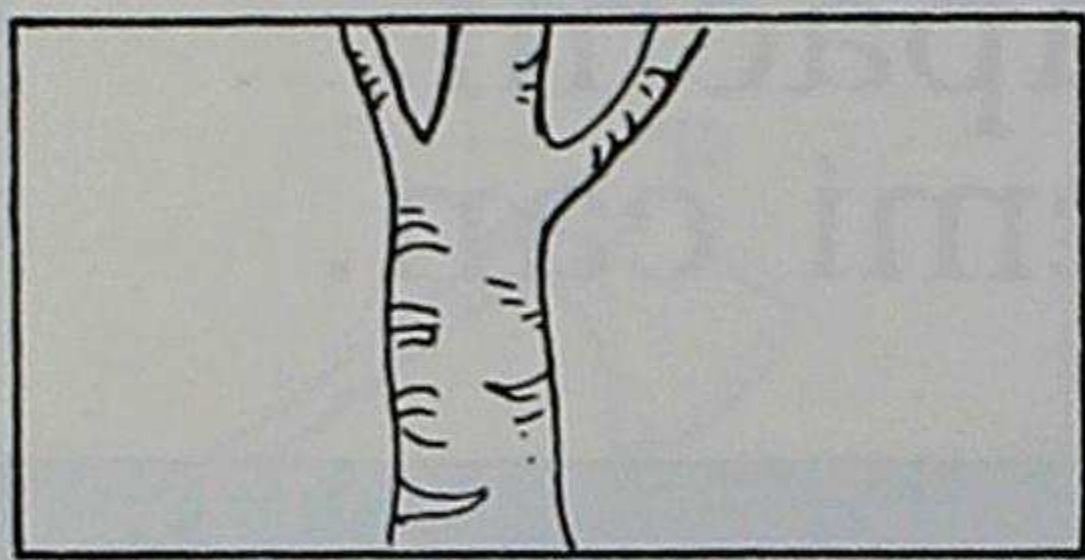

caspi

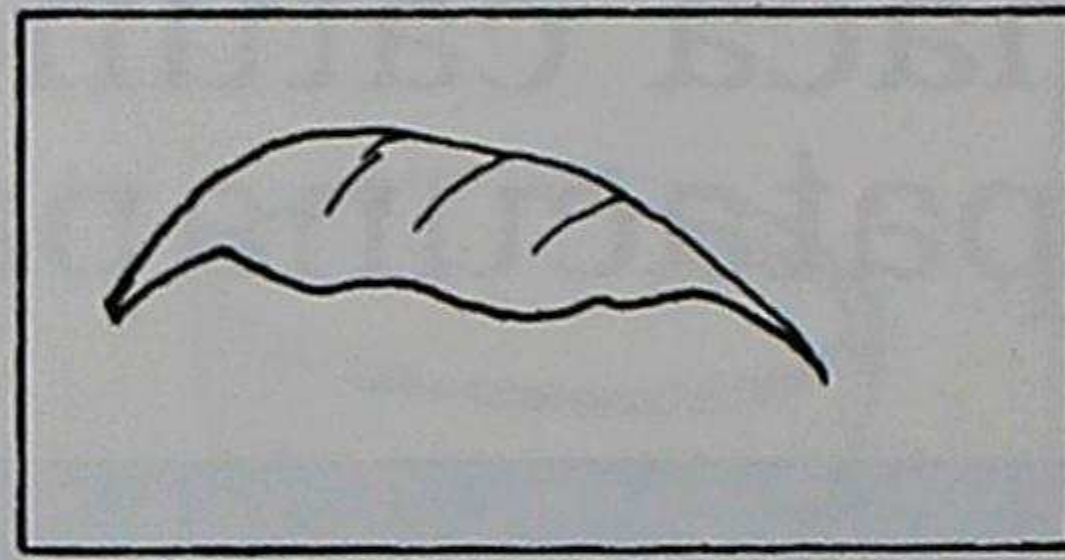

panca

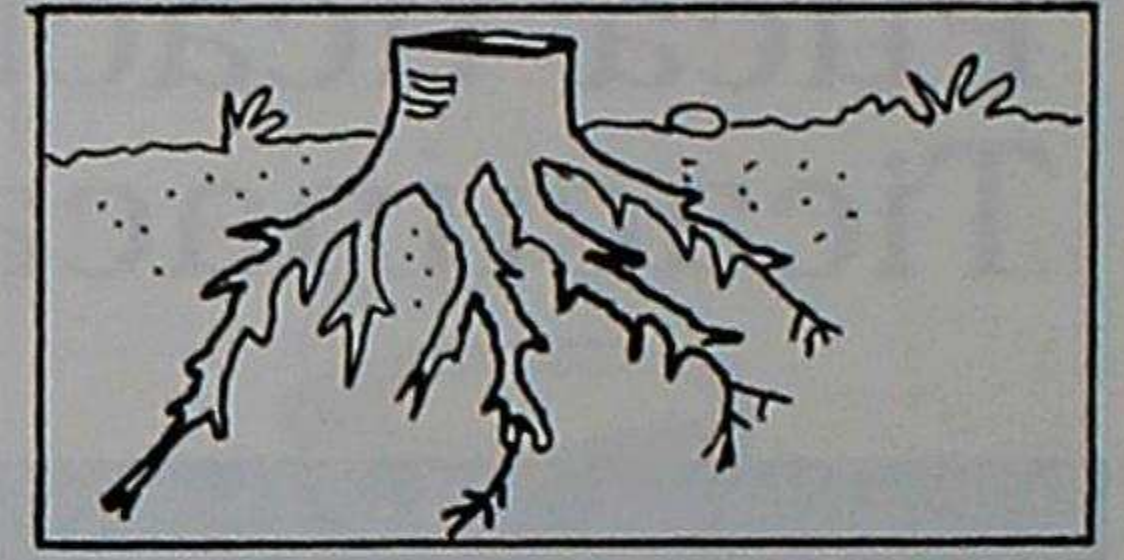

sapi

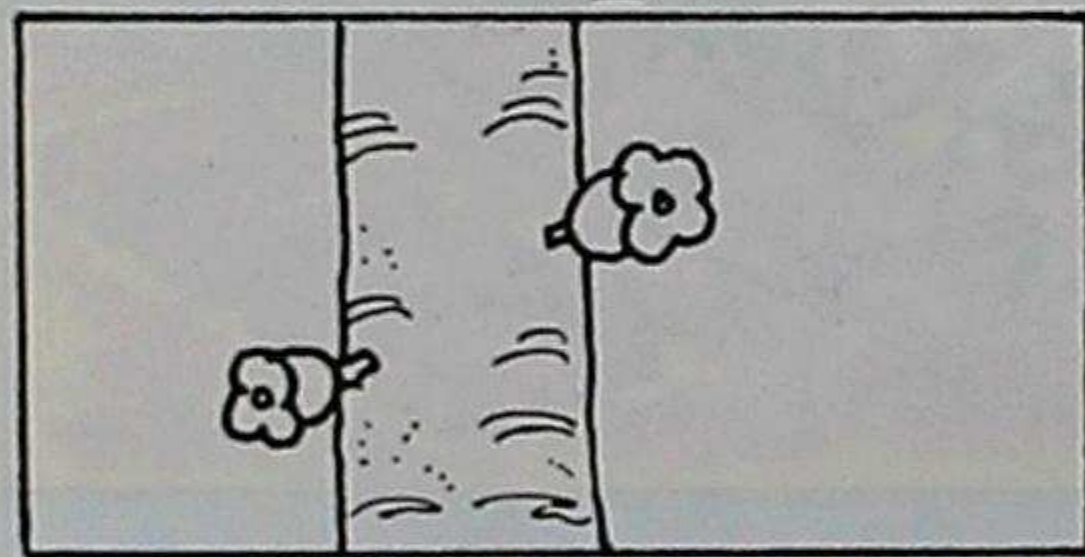

sisa

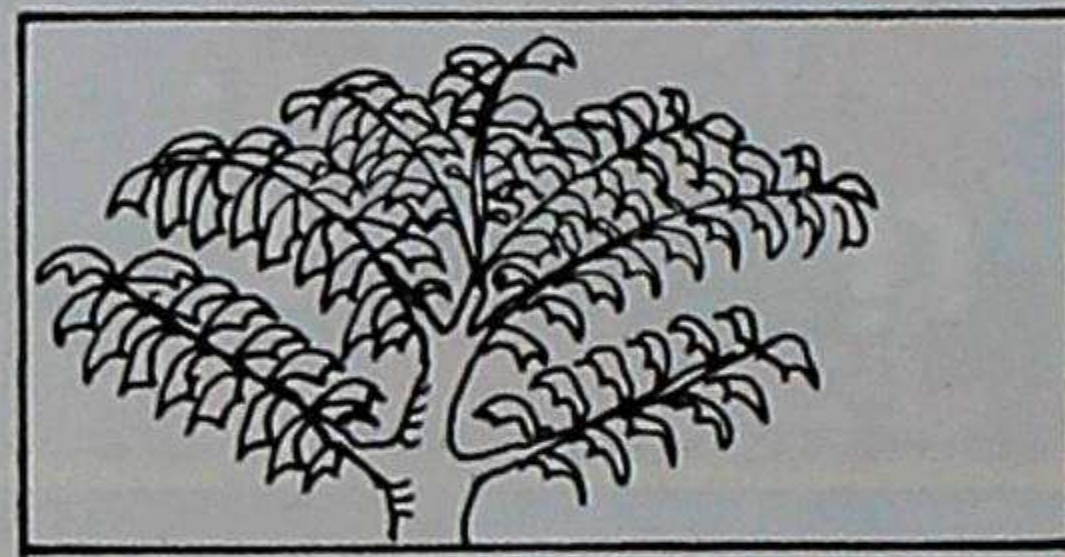

uma

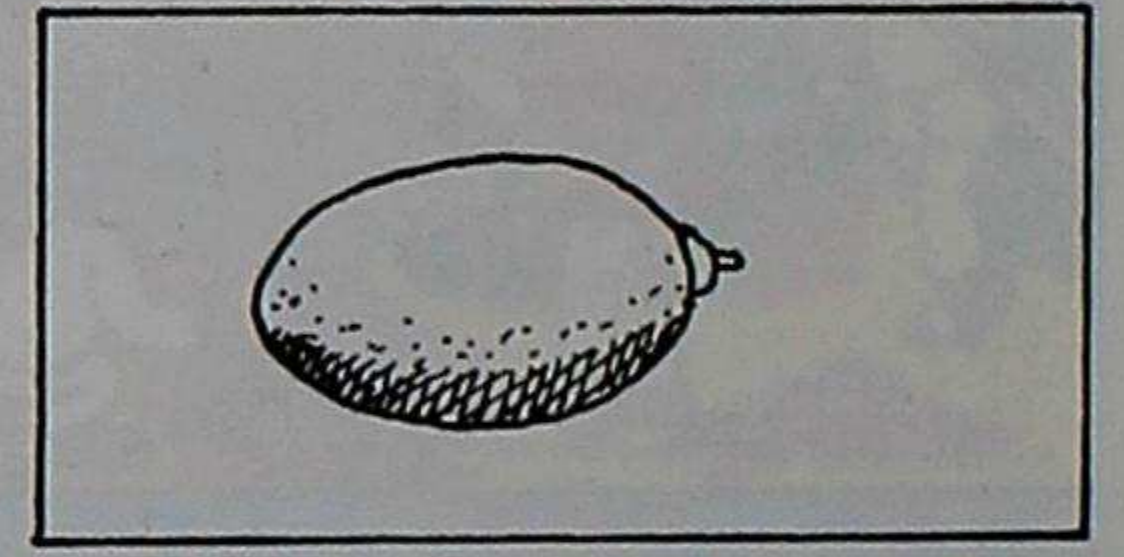

mati

## Matimanta

Cai mati sisaca sumacmi can.

Matica pancasapami can.

Sapimantami matica causan:  
upian, micun, pucun.

Paica maticunatami cun.

Matica upiancapac, micuncapacmi  
can.

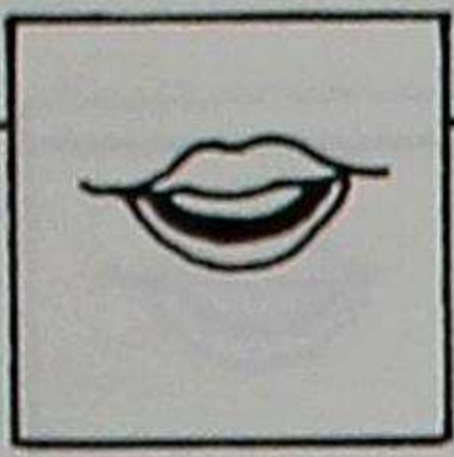

sincasapa



umasapa



cuncasapa

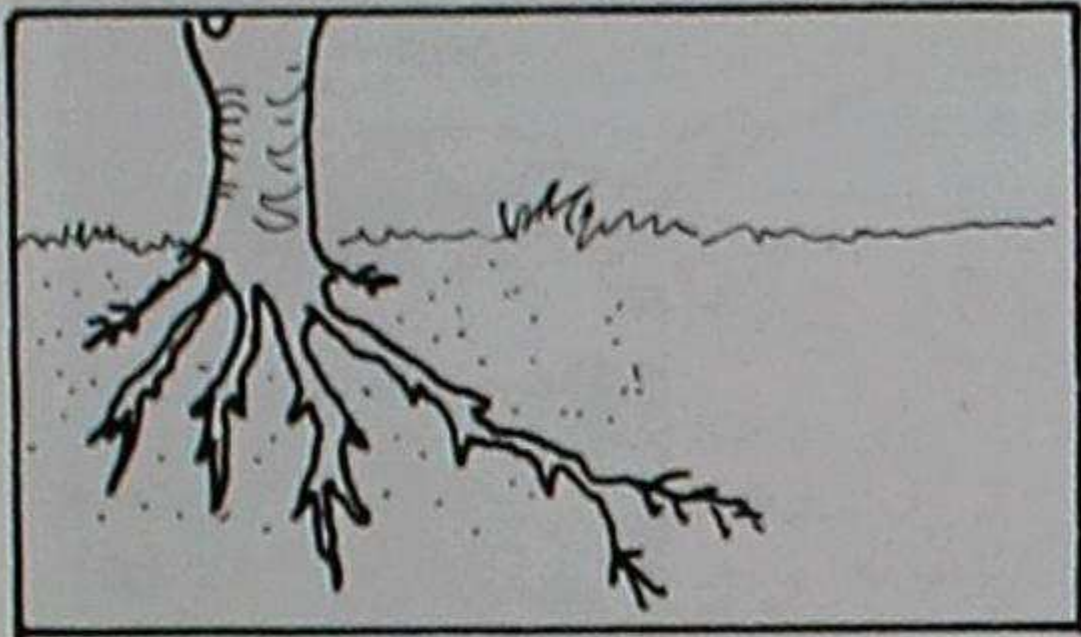

sapisapa

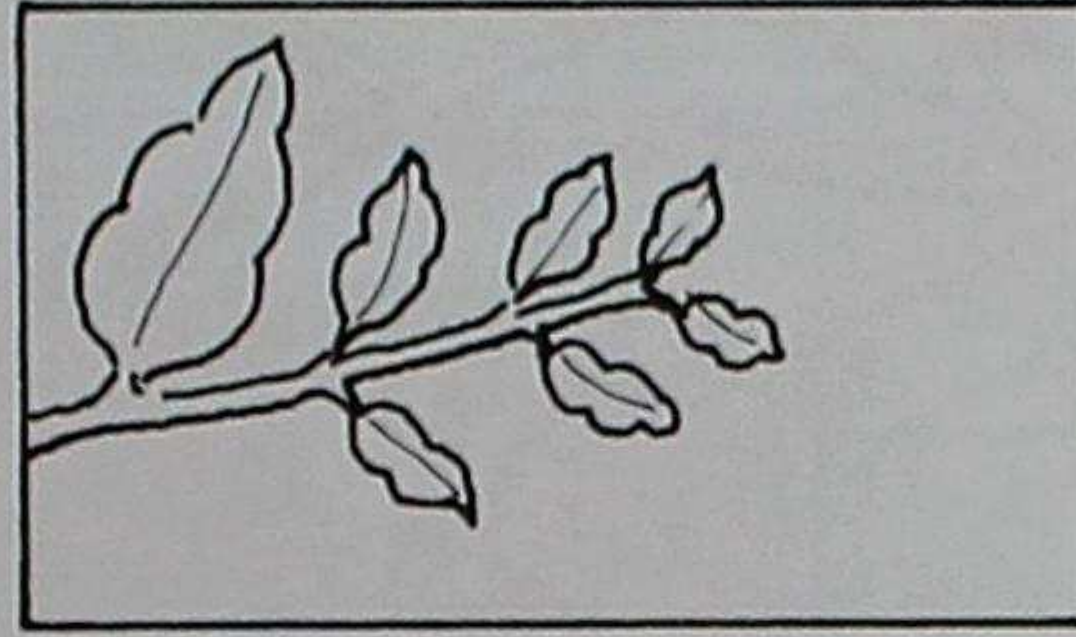

pancasapa

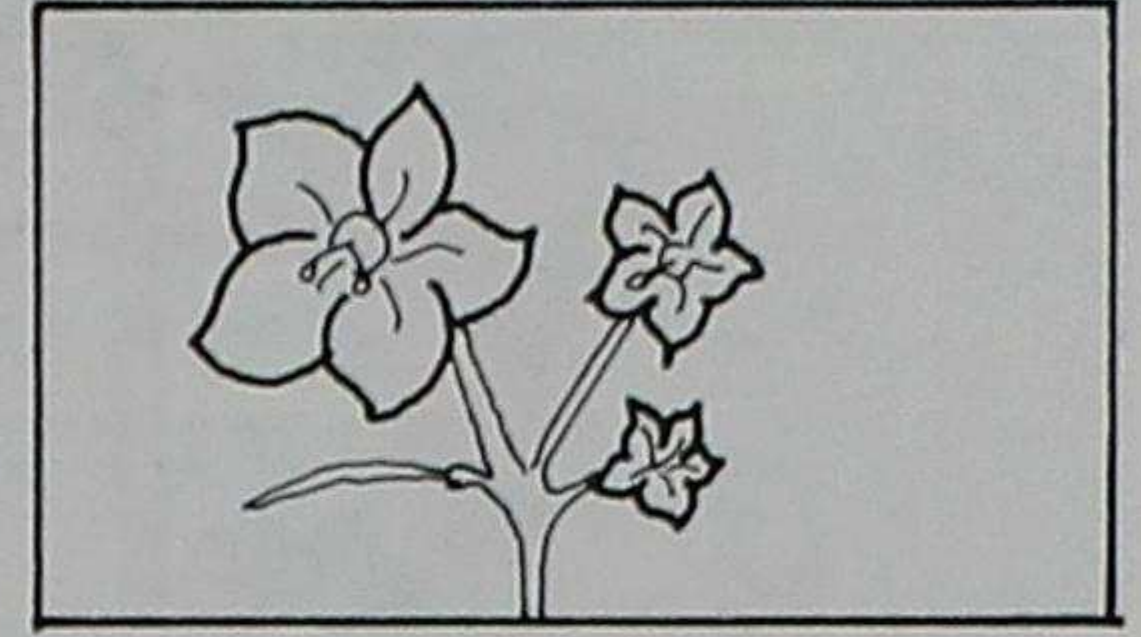

sisasapa

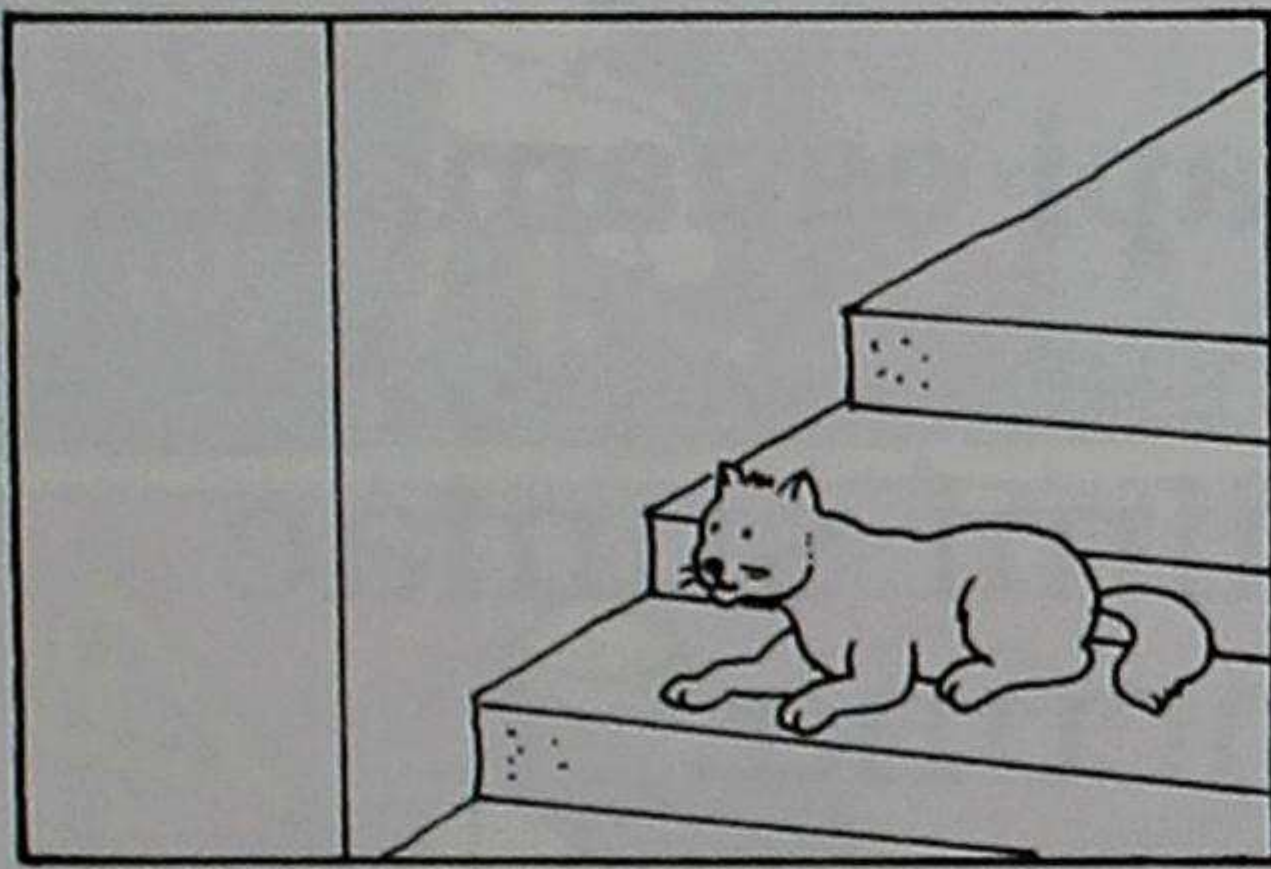

Misica patapimi

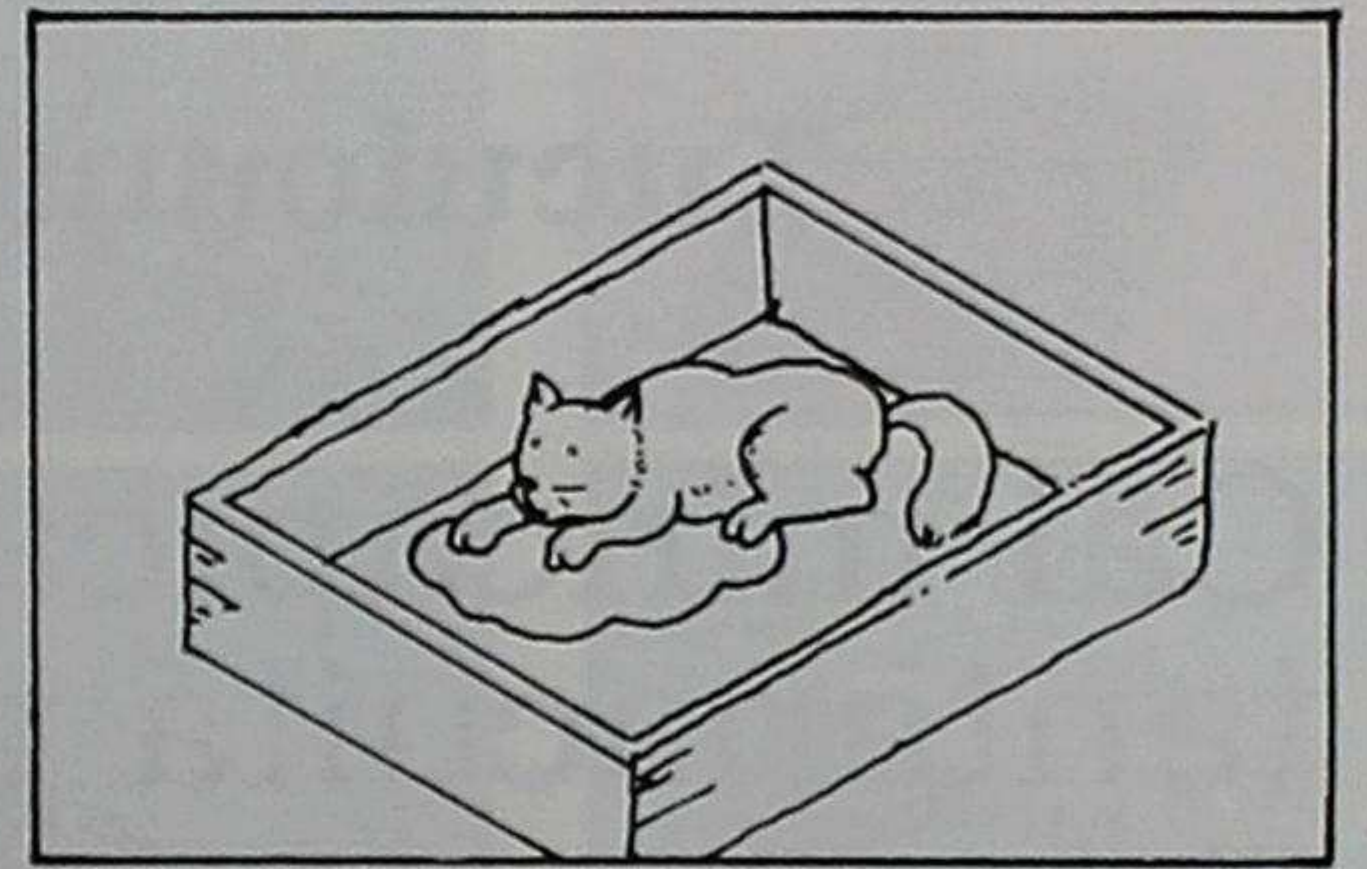

Misica.ucupimi

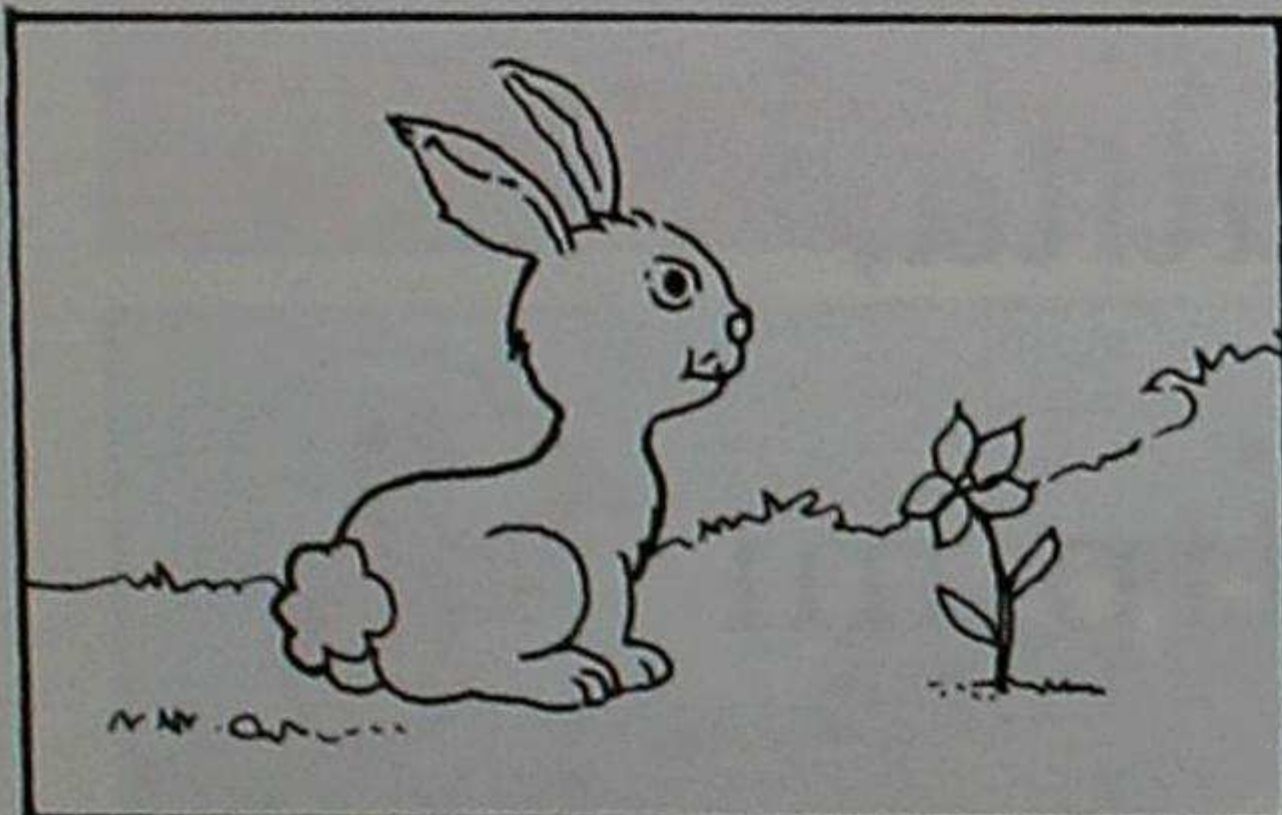

Cunuca panpapimi

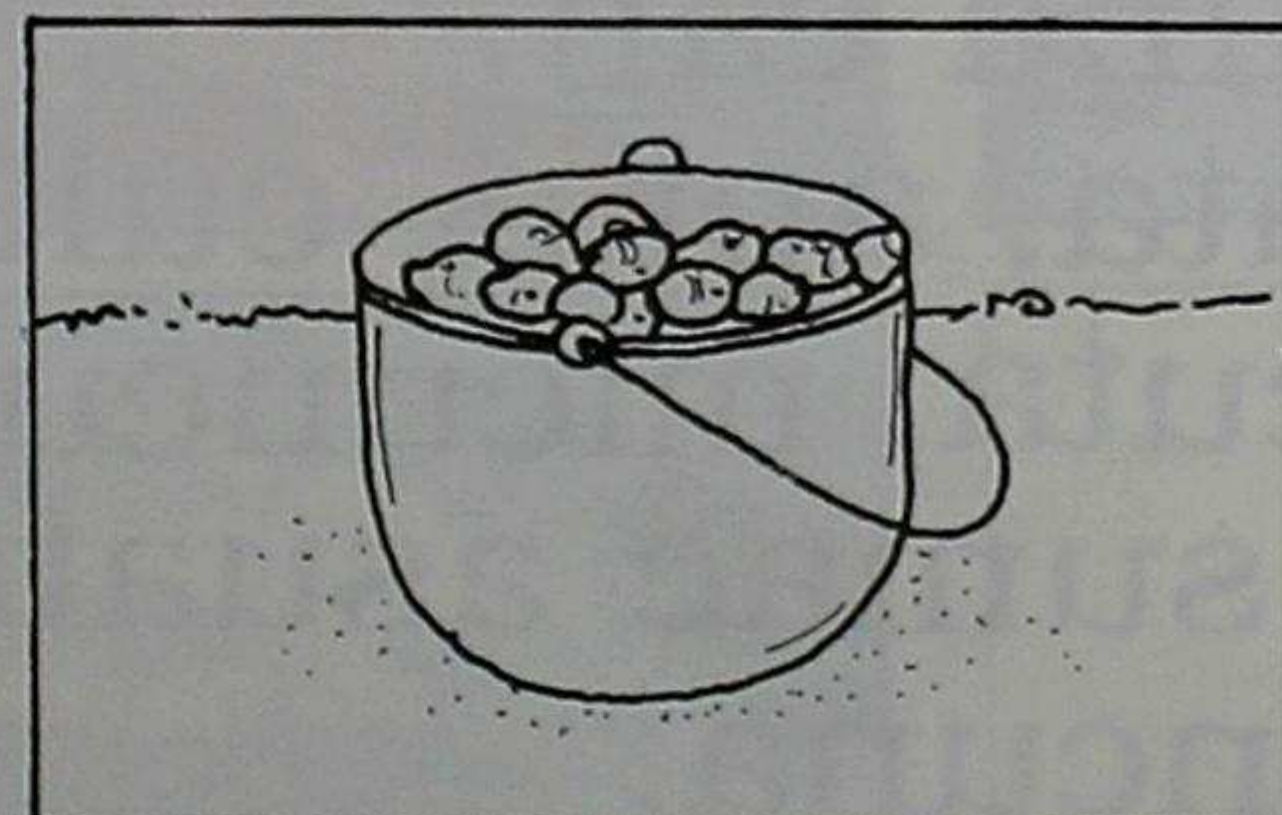

Papaca mancapimi

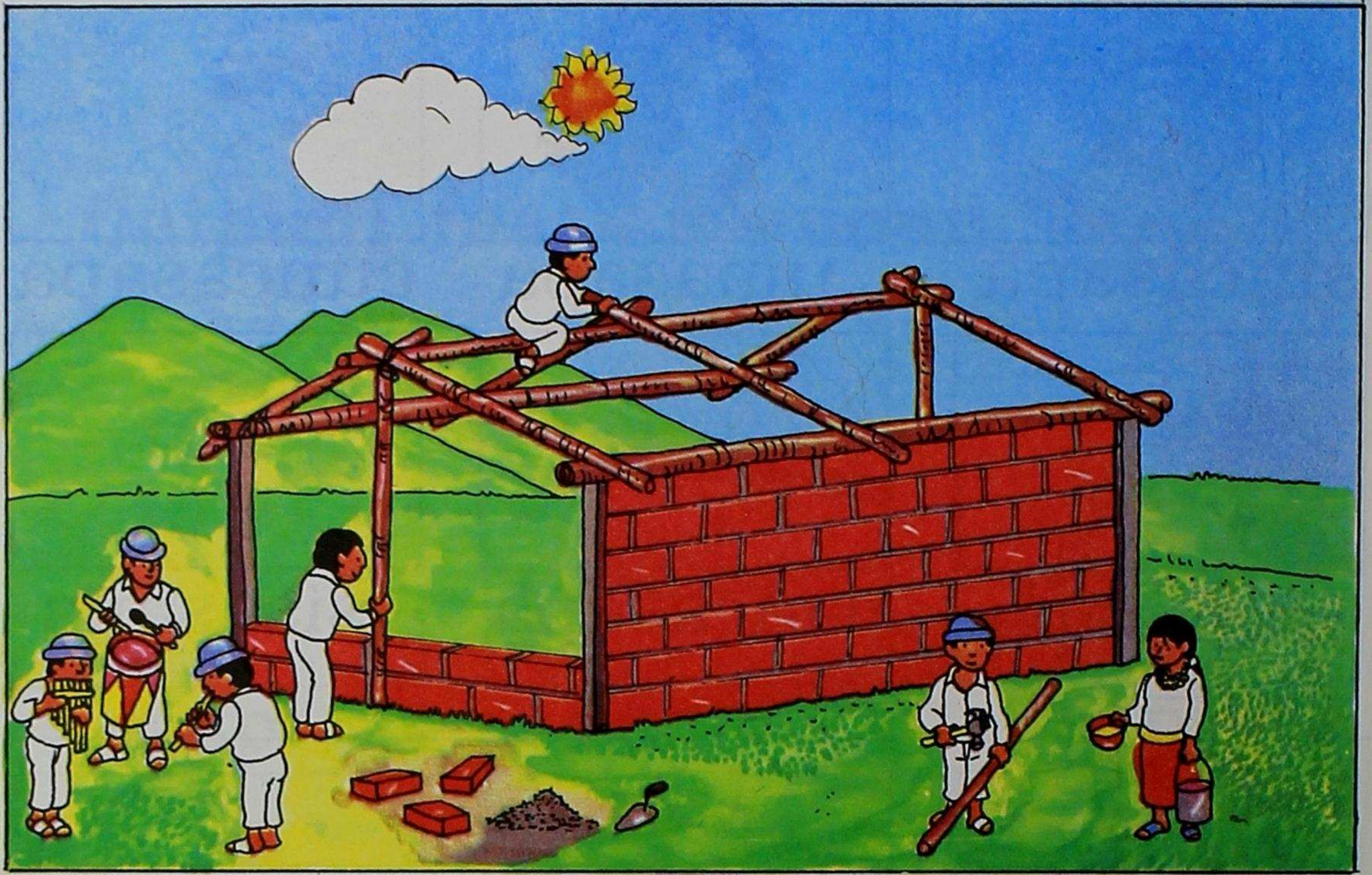
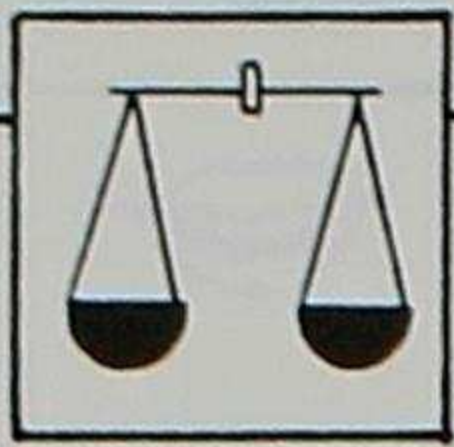

## **Tucuicuna mincapi canamanta**

Cai mincapica tucuimi sumiac  
tantanacuita pactancuna.

Tucuicunami cai mincapica  
cainana can.

Papata, apita, cuita, mutita,  
sancuta, micuncunami.

Mai sumac asuata matipimi  
upiancuna.

Cai causaica sumacmi can.

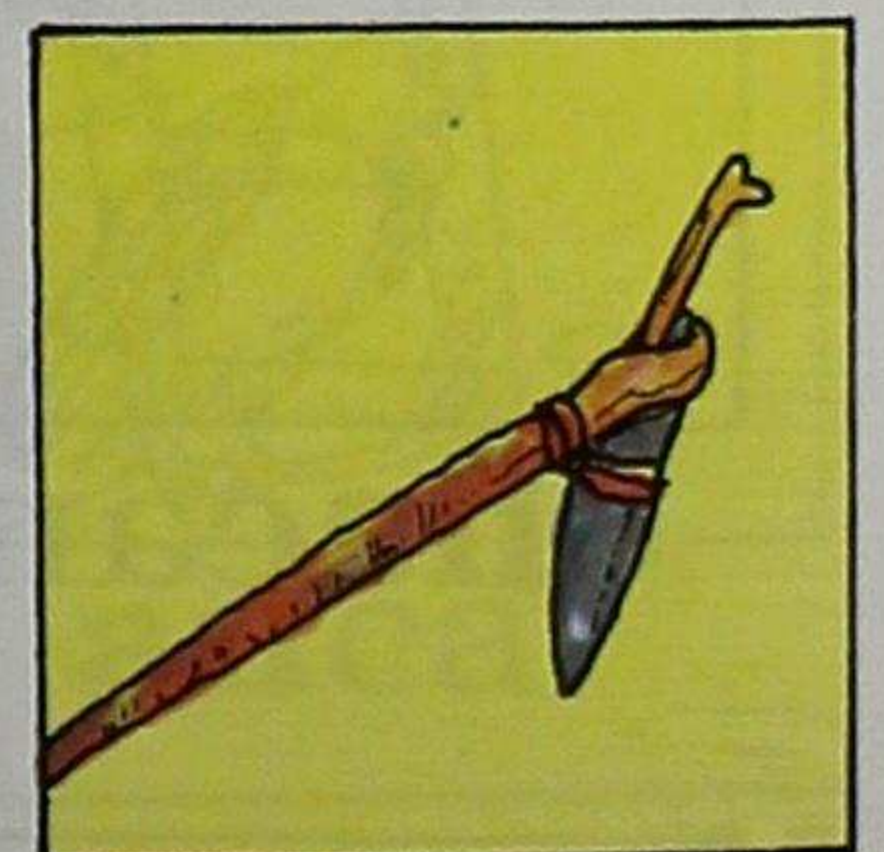
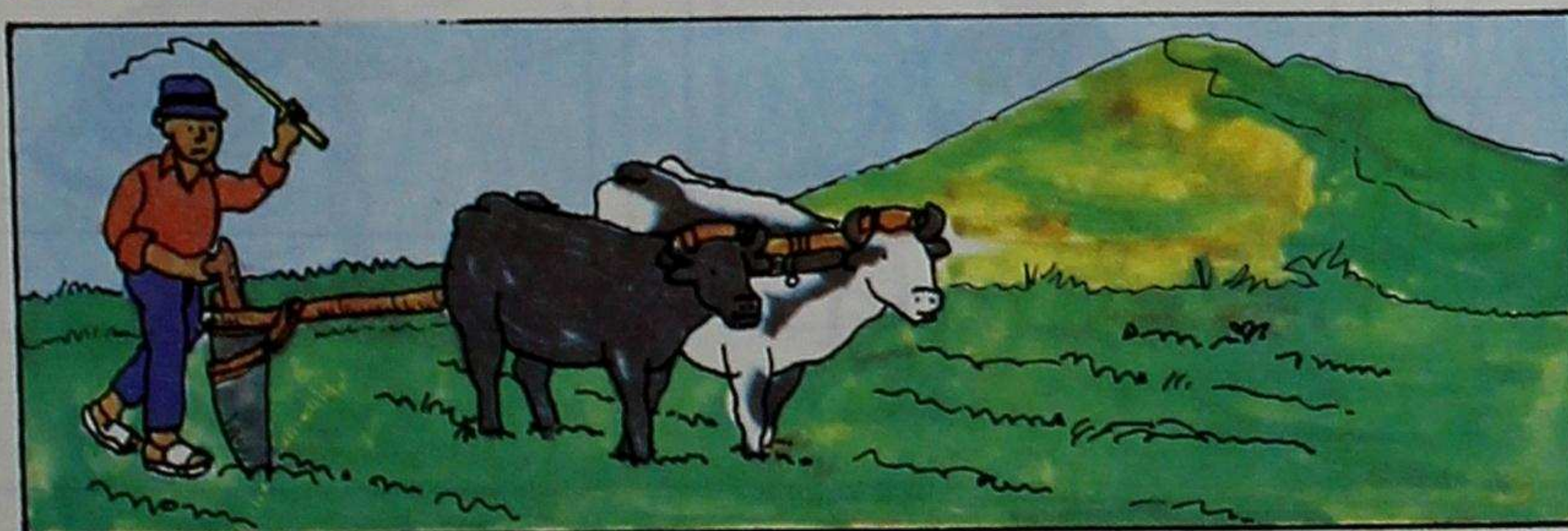
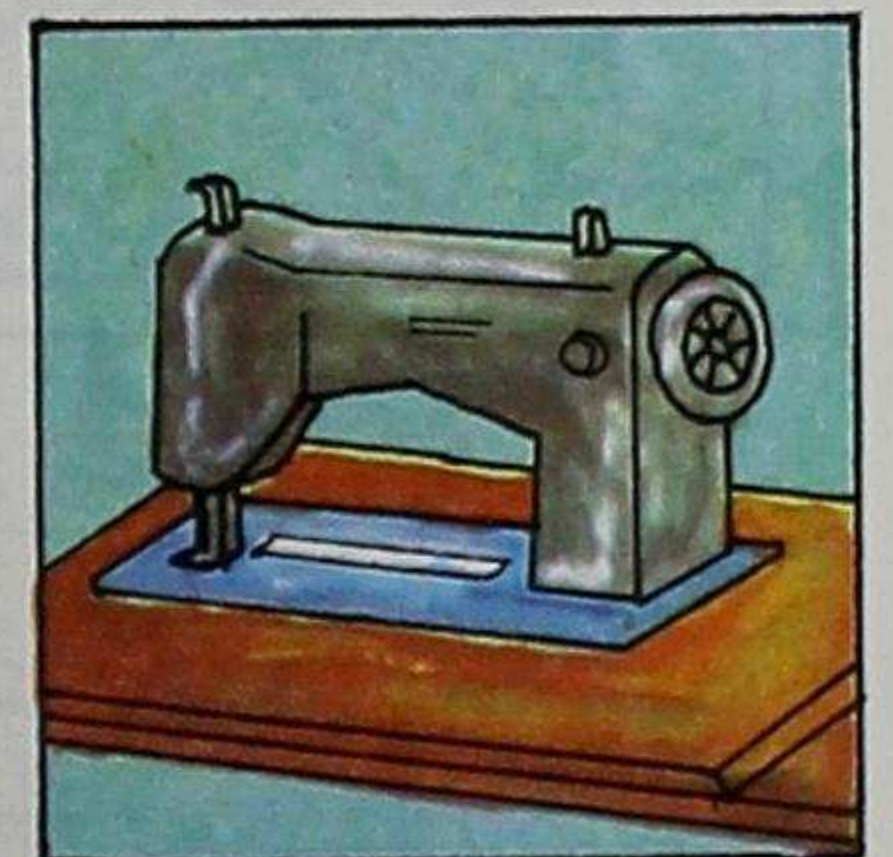
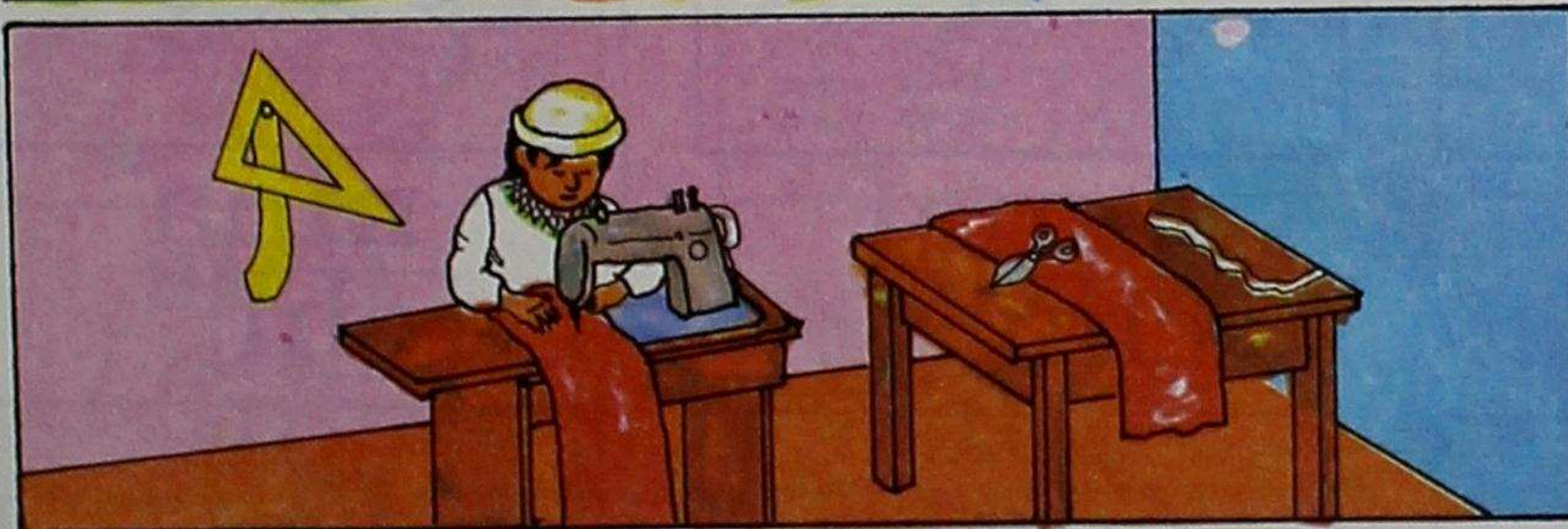
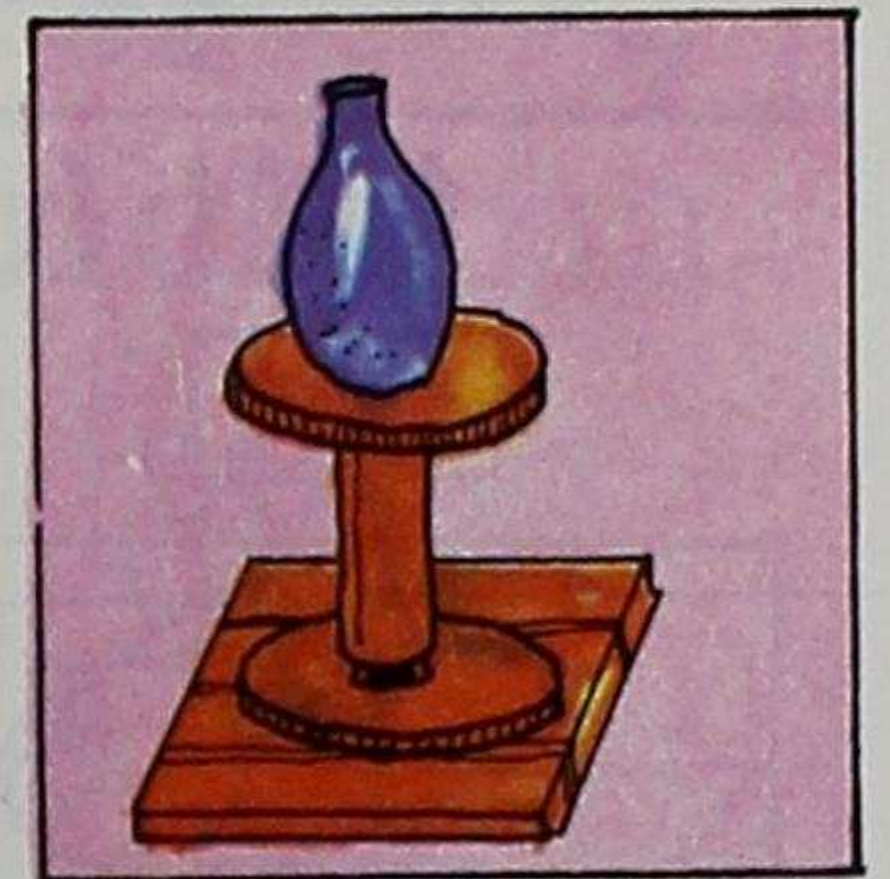
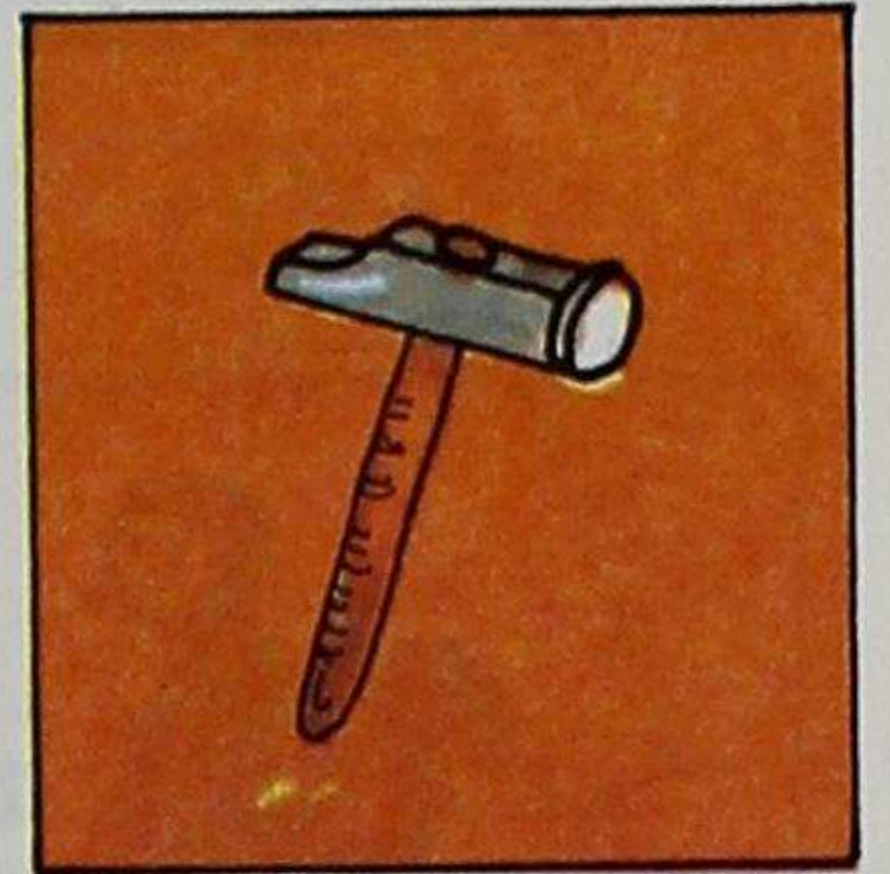
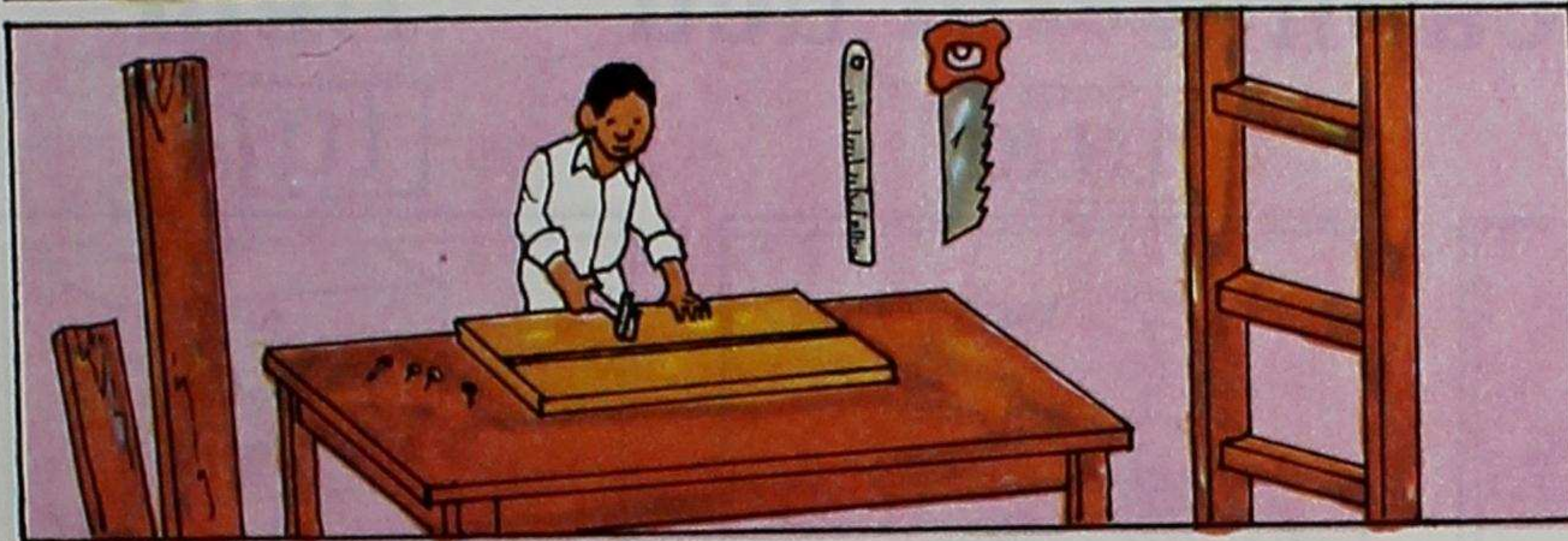
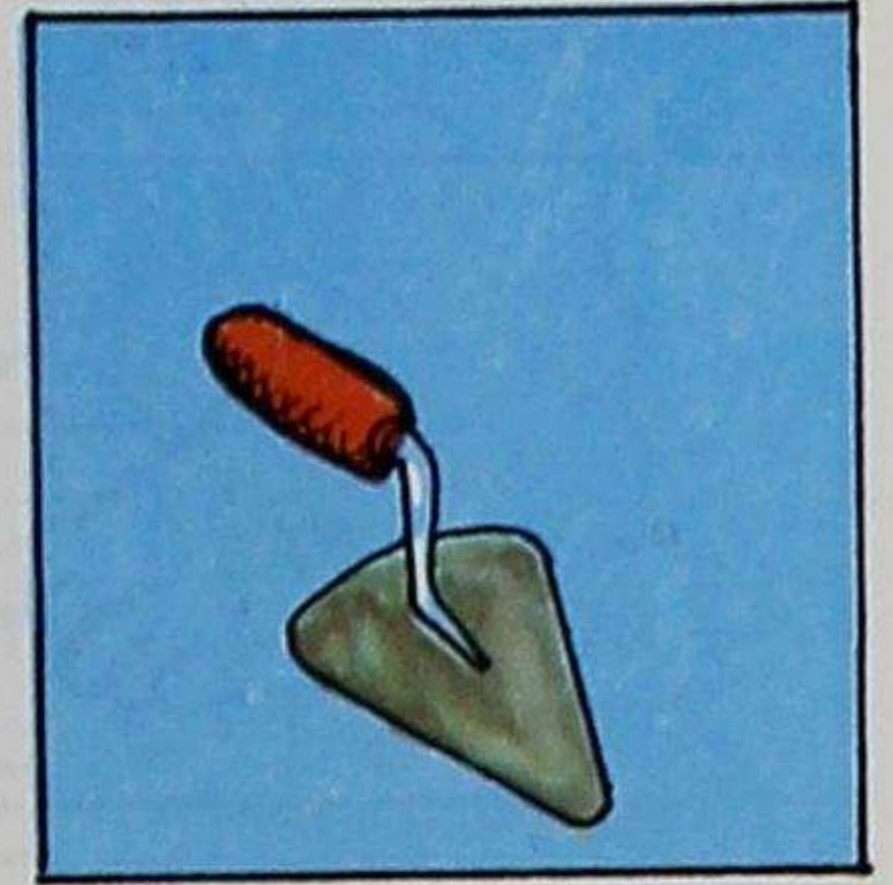
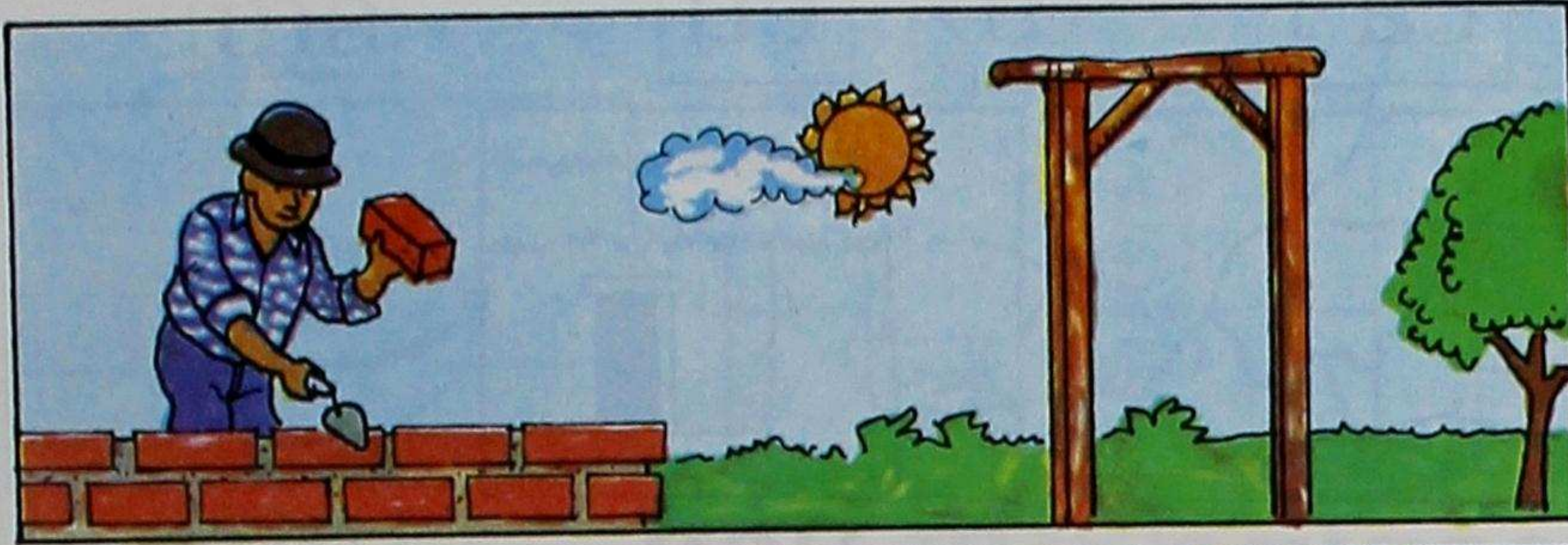
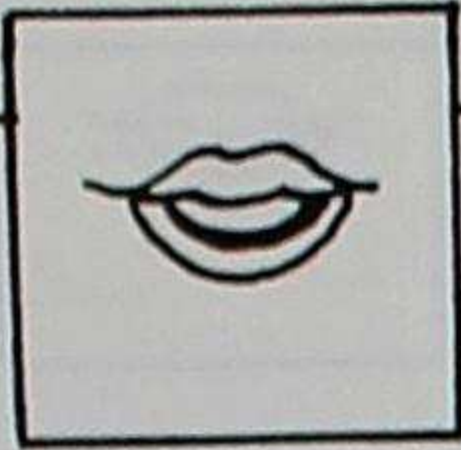



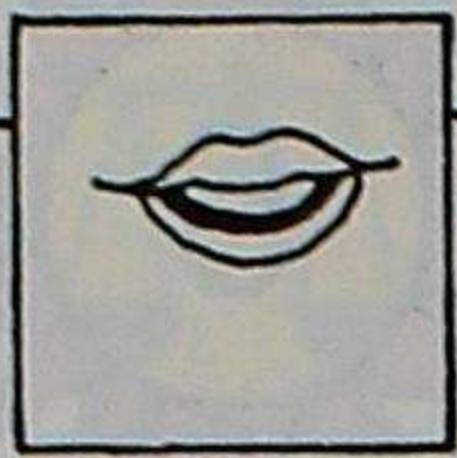

ca

cu

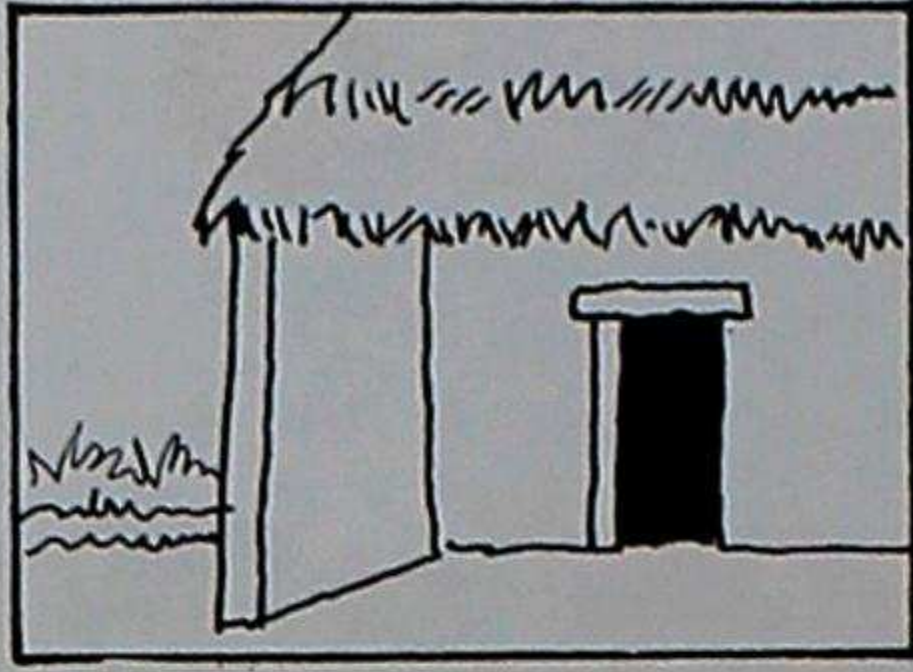
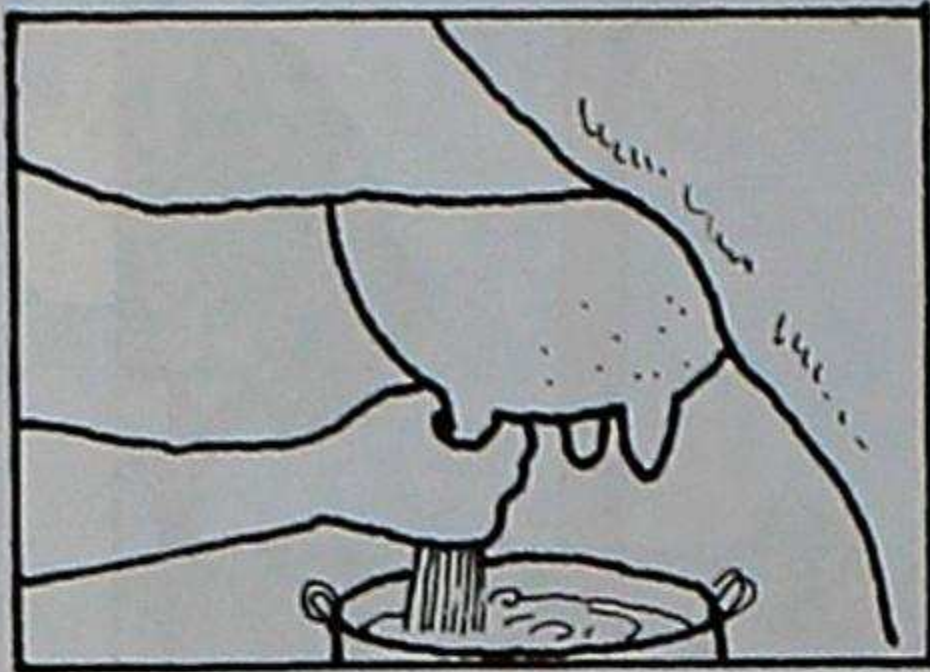

capina

ucu

ti

ta

tu

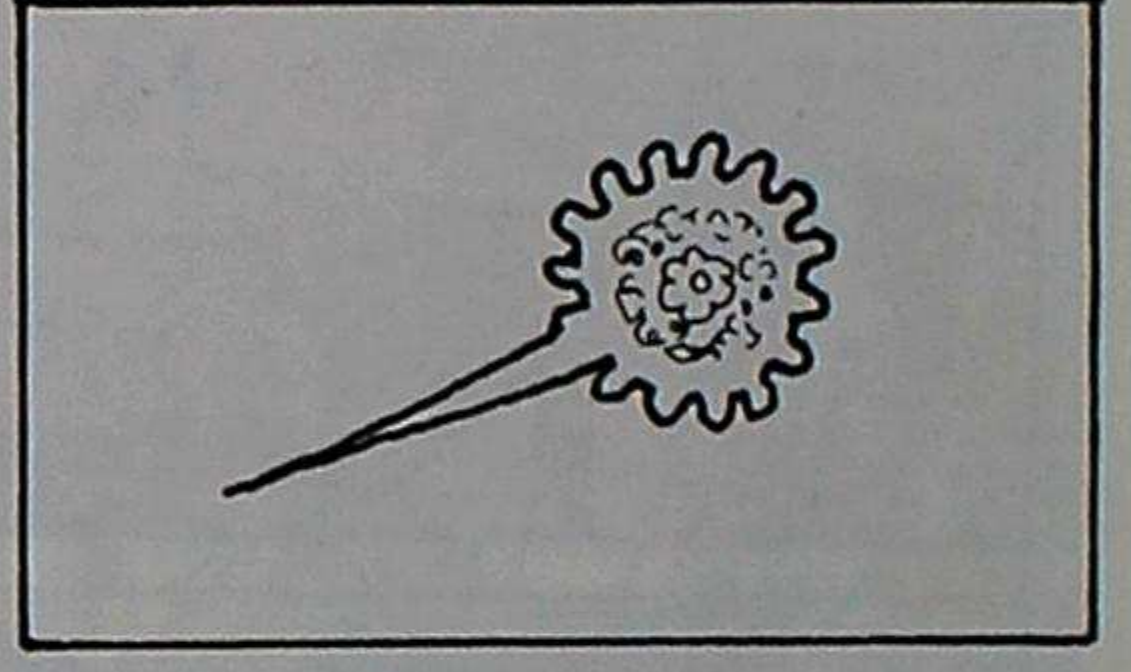
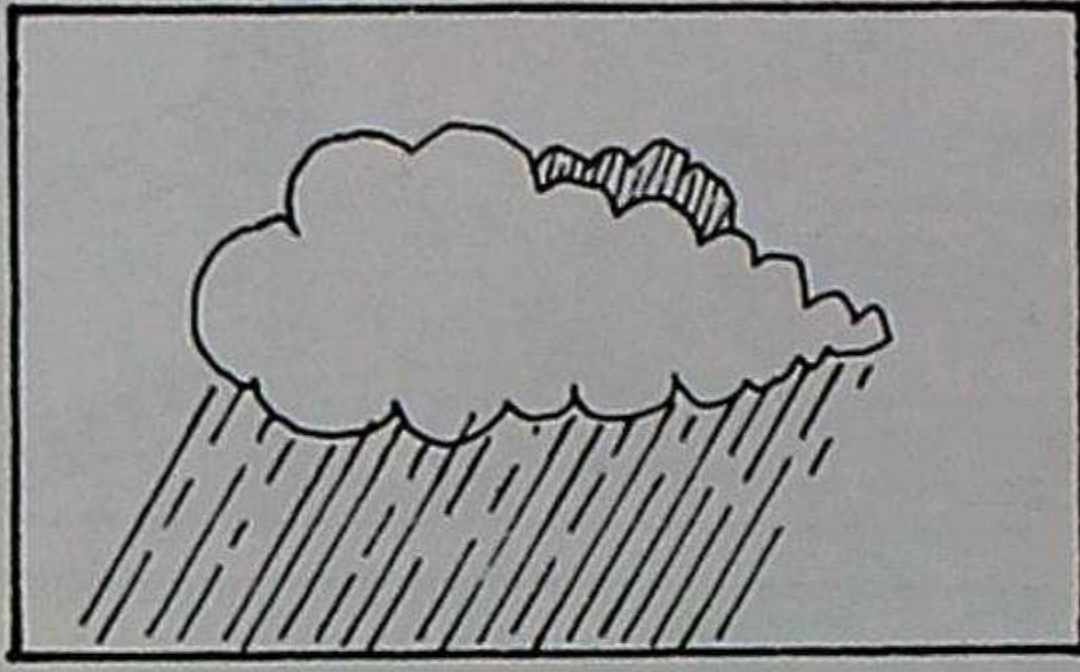

titi

tamia

tupu

nu

na

ni

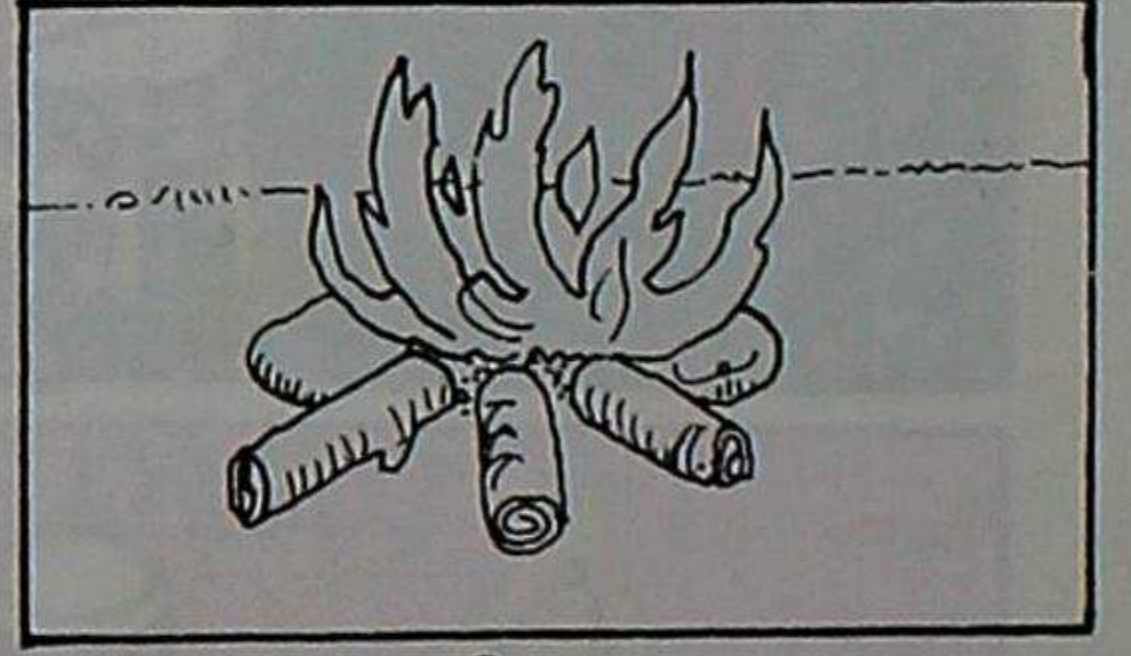
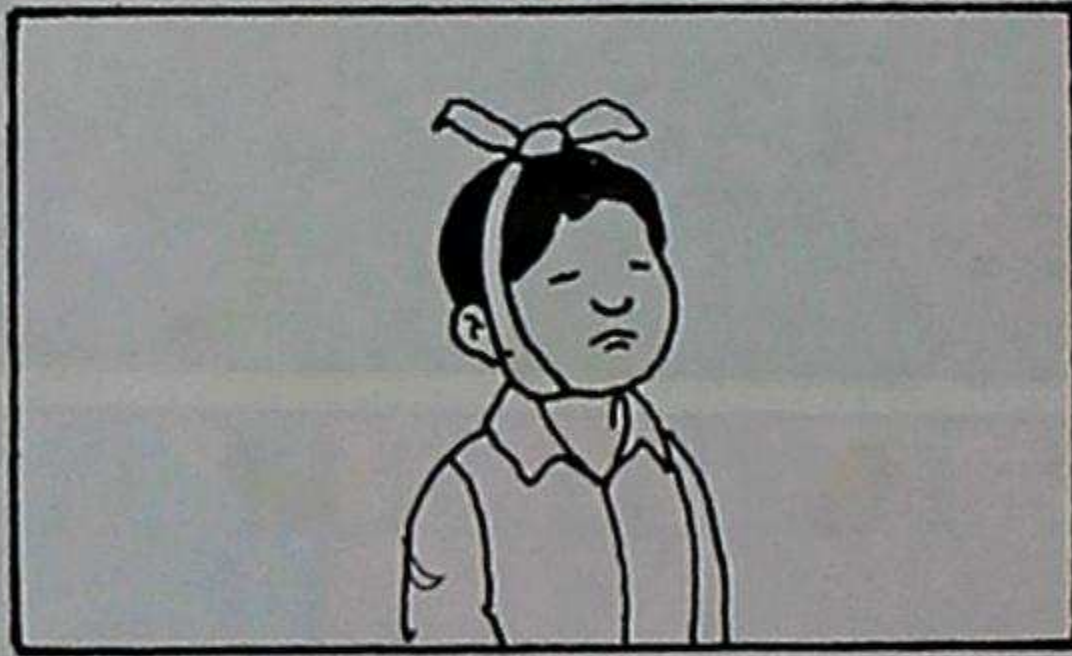
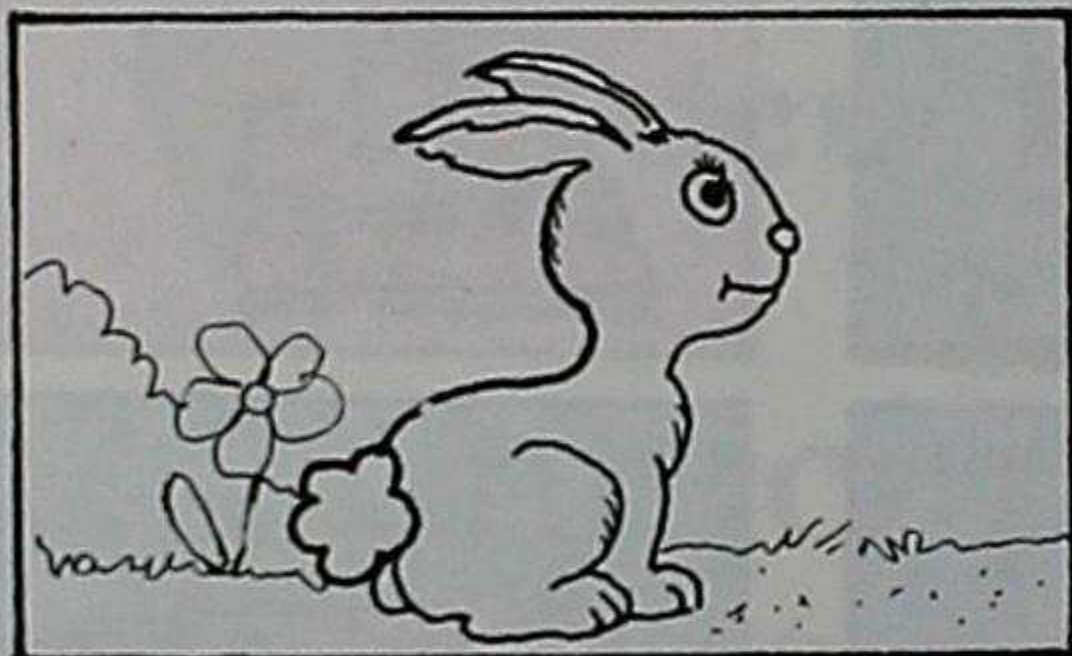

cunu

nanai

nina

cha

chu

chi

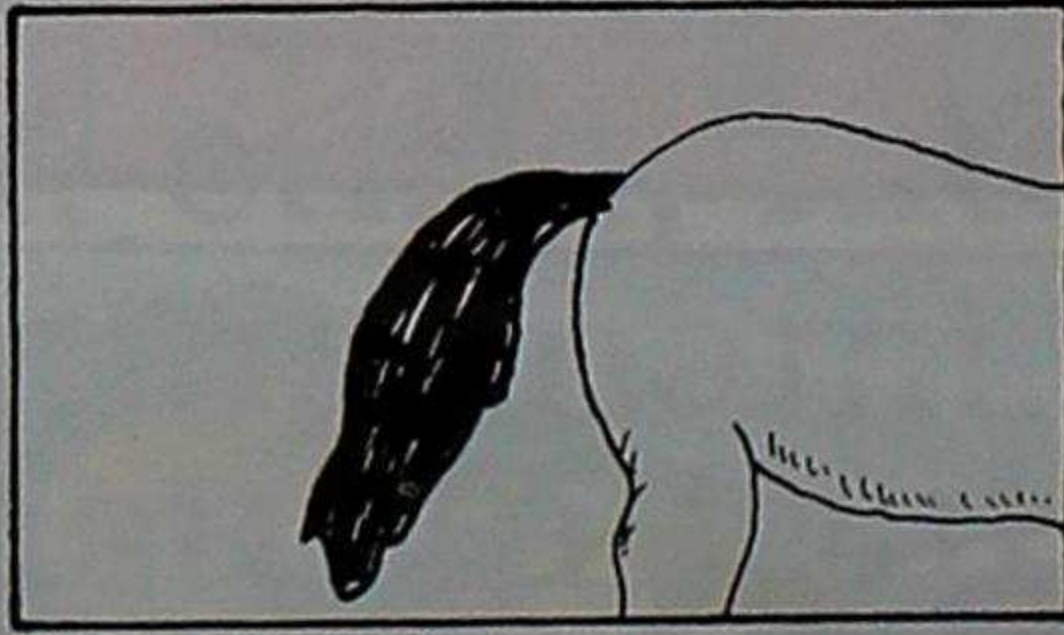
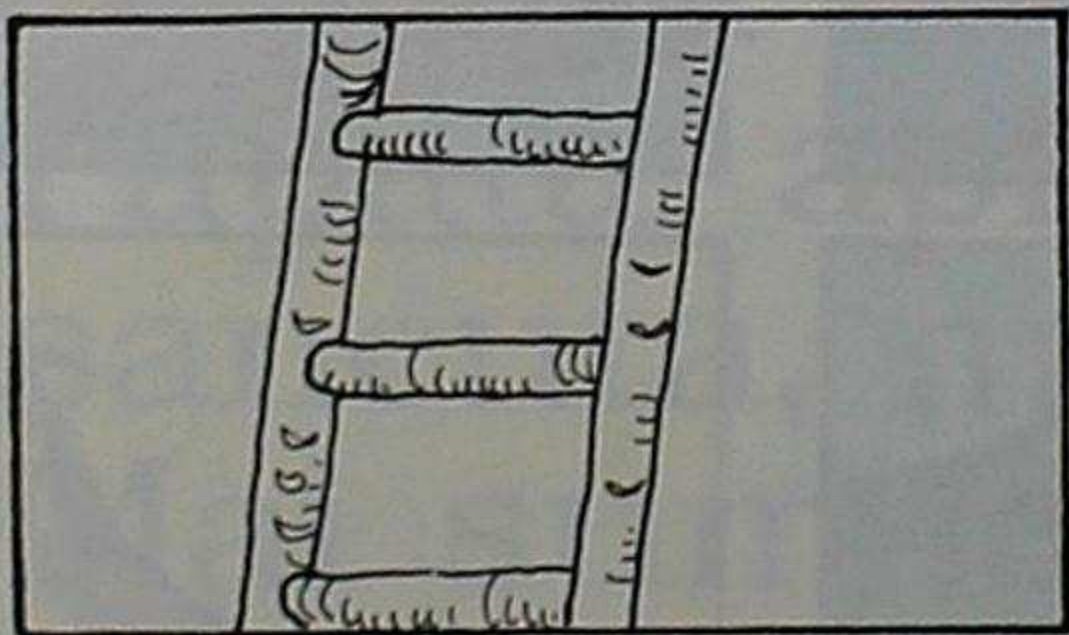

chacana

chupa

chichicu

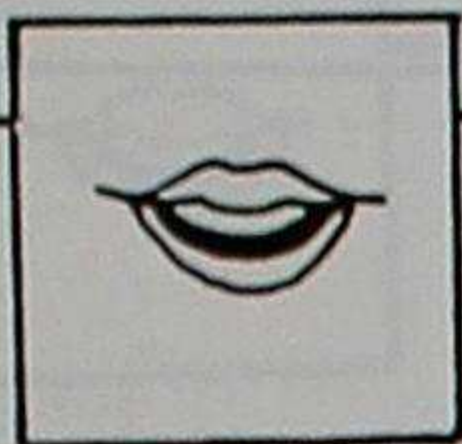

ma

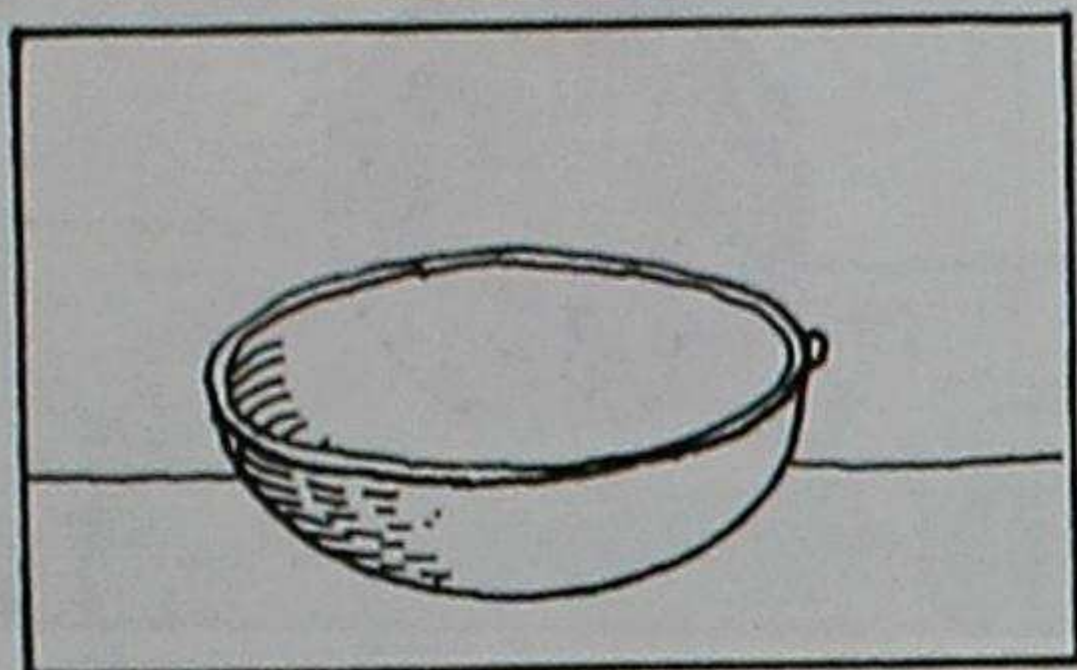

**mati**

mi

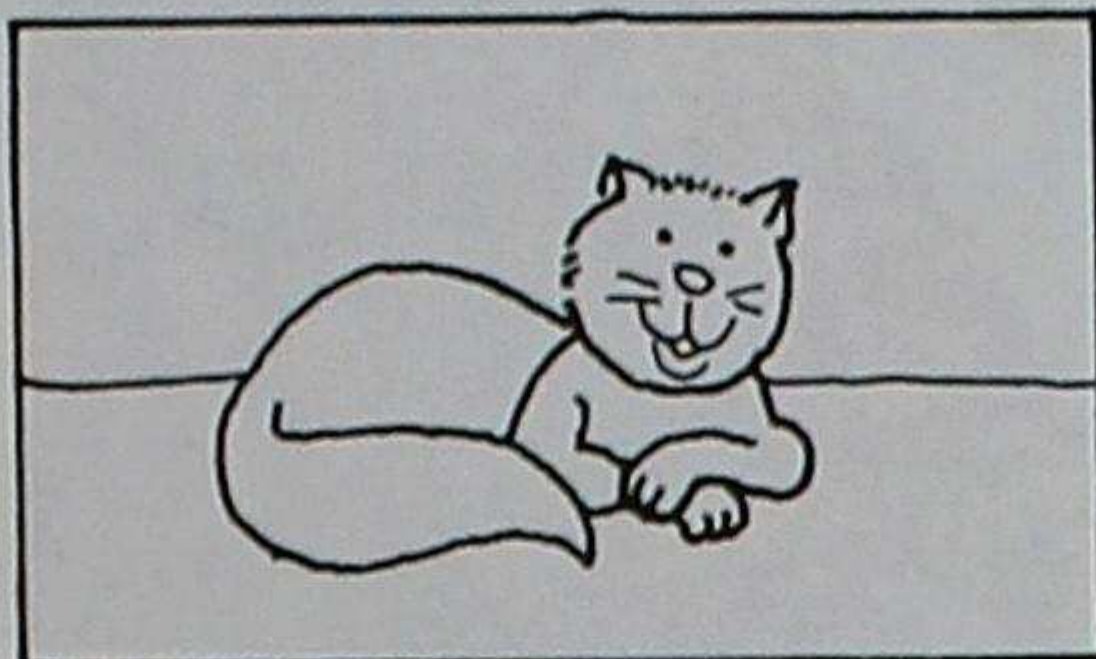

**misi**

mu

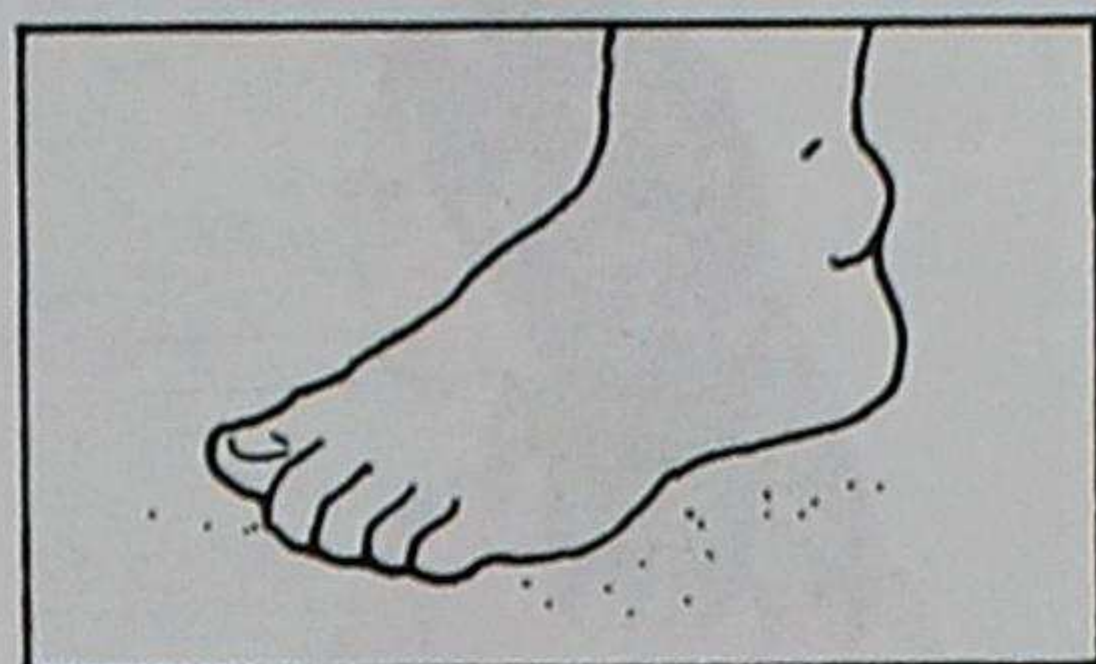

**mucu**

pa

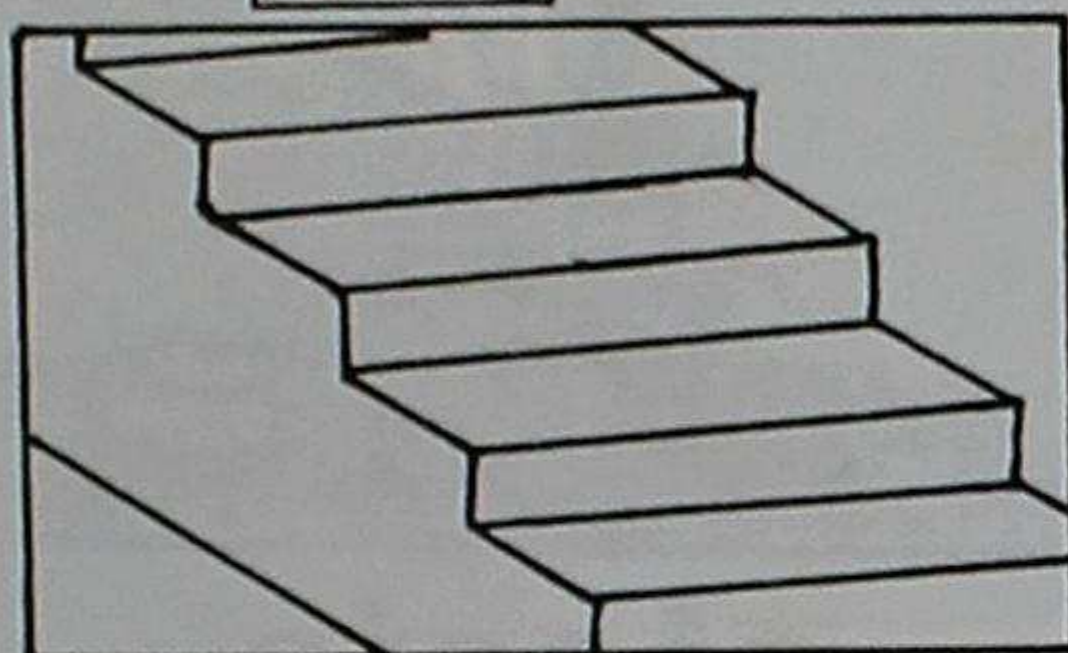

**pata**

pu

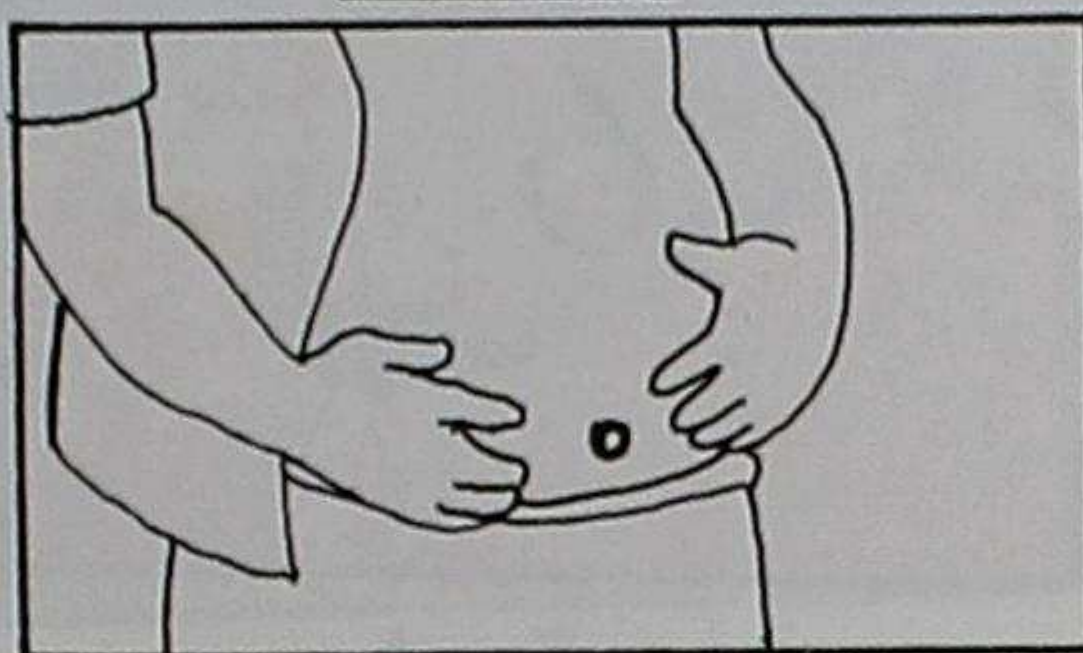

**pupu**

pi

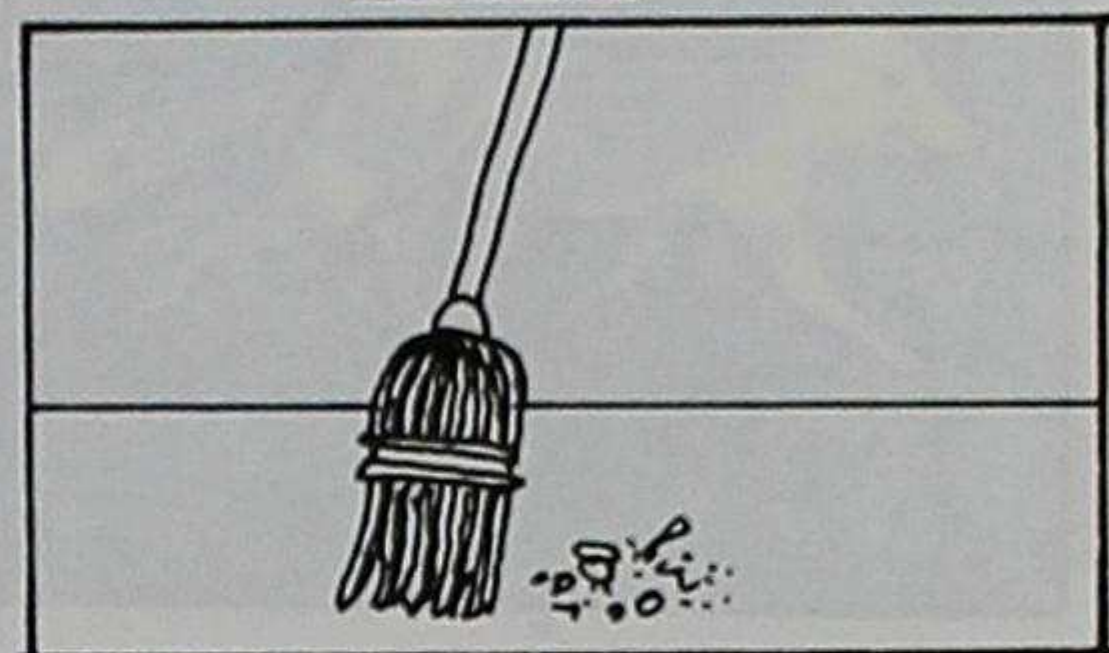

**pichana**

si

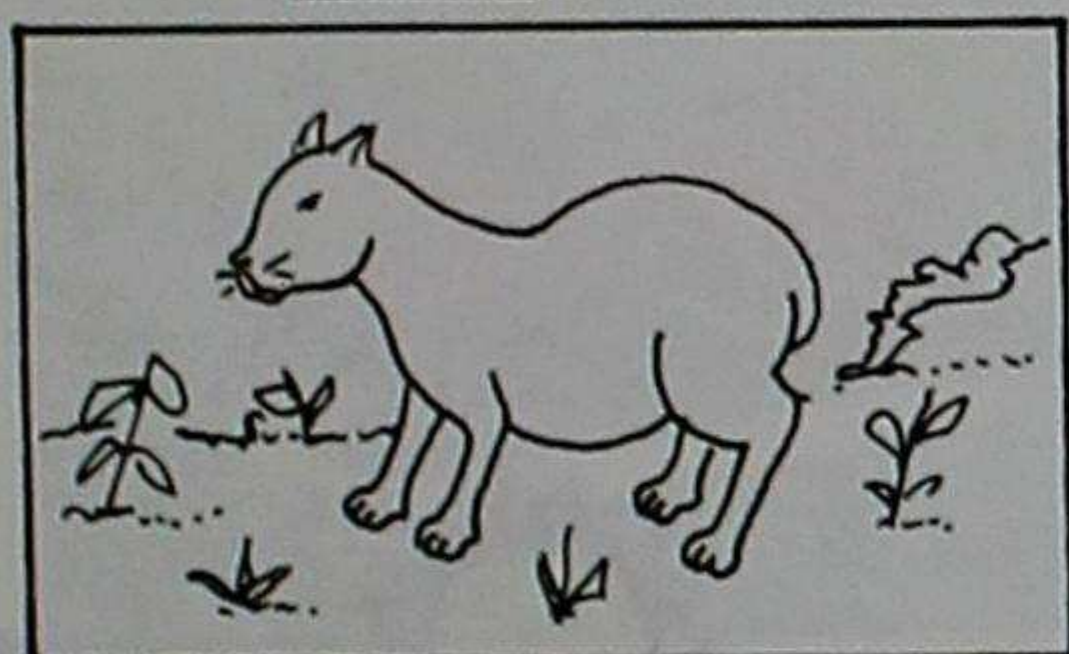

**sicu**

su

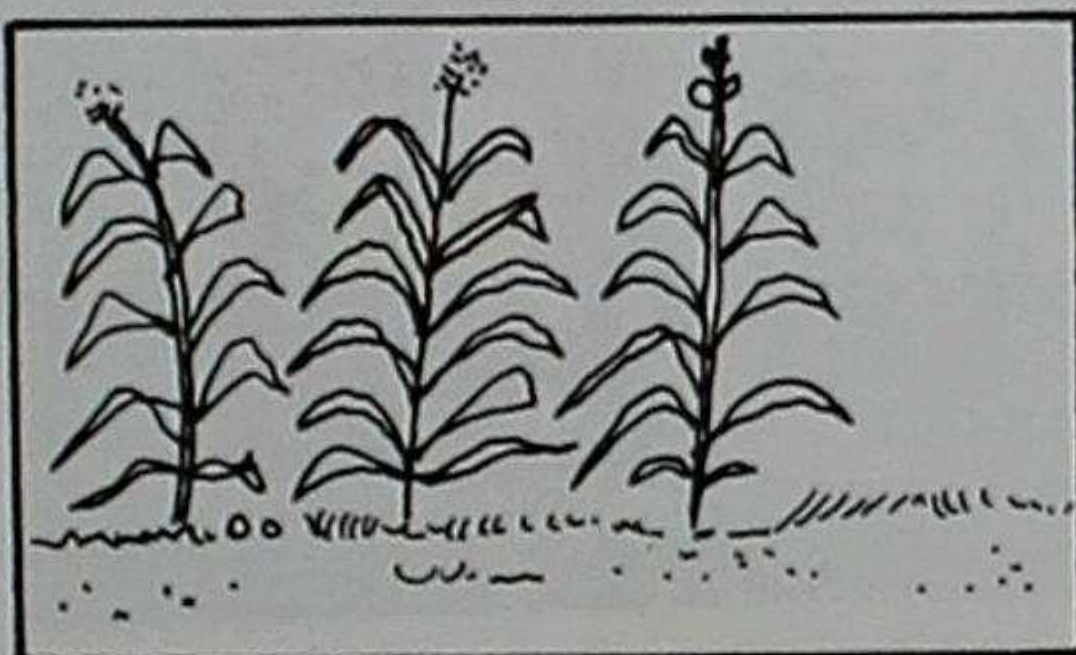

**sucus**

sa

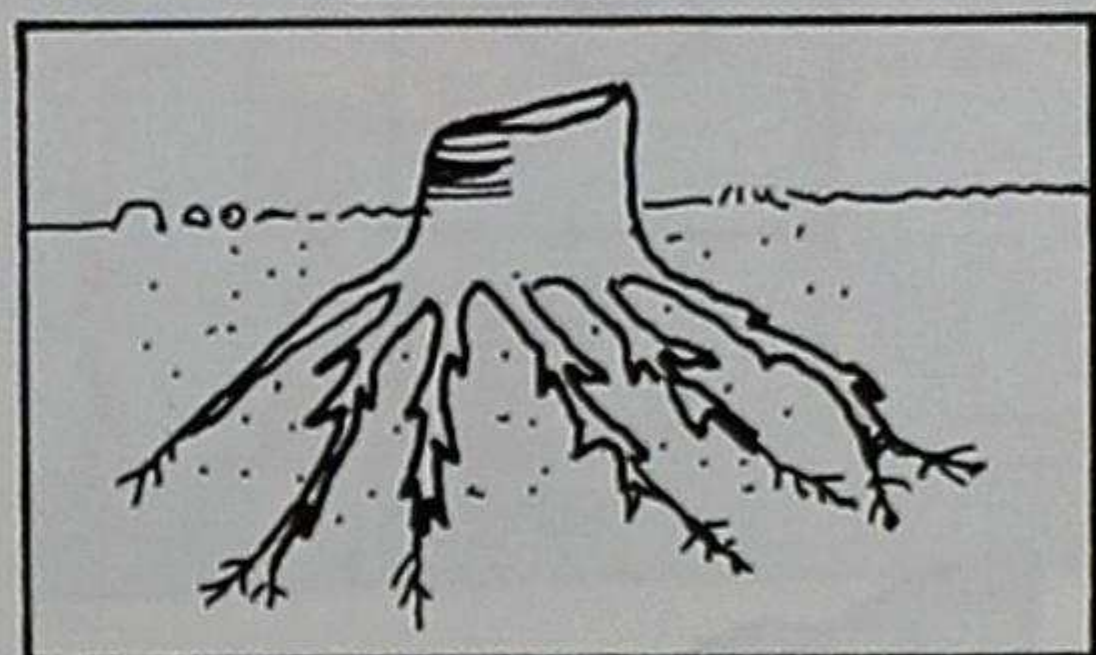

**sapi**

in



**inca**

un



**uncuc**

an

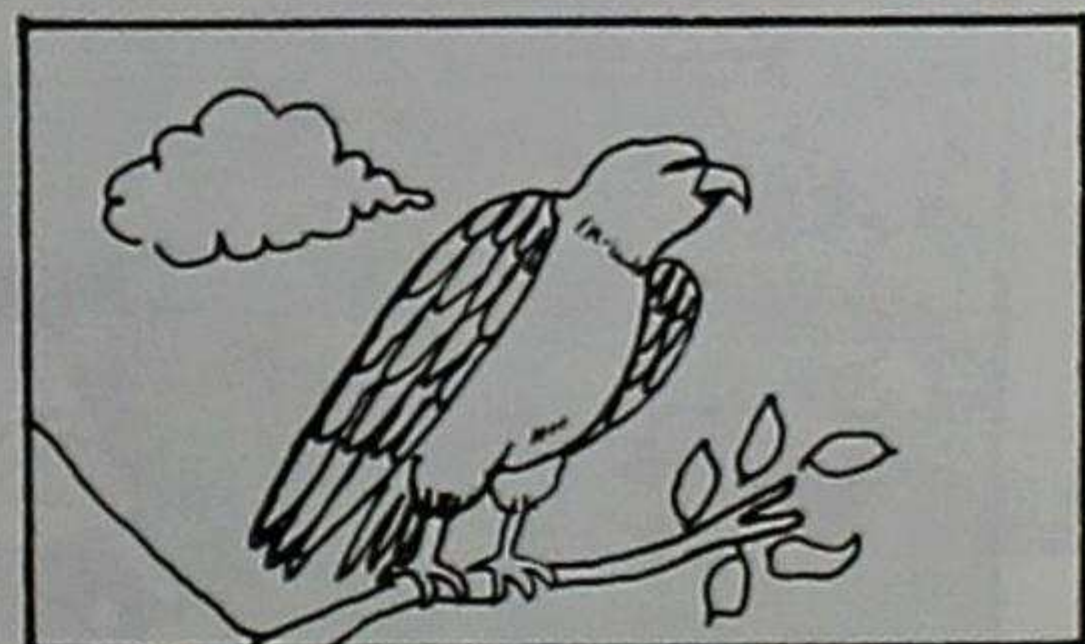

**anca**

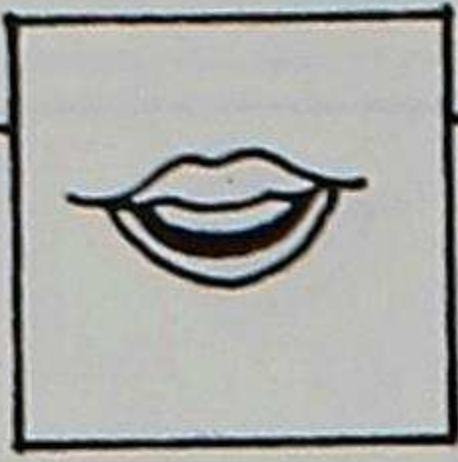

**accha**



**paccha**

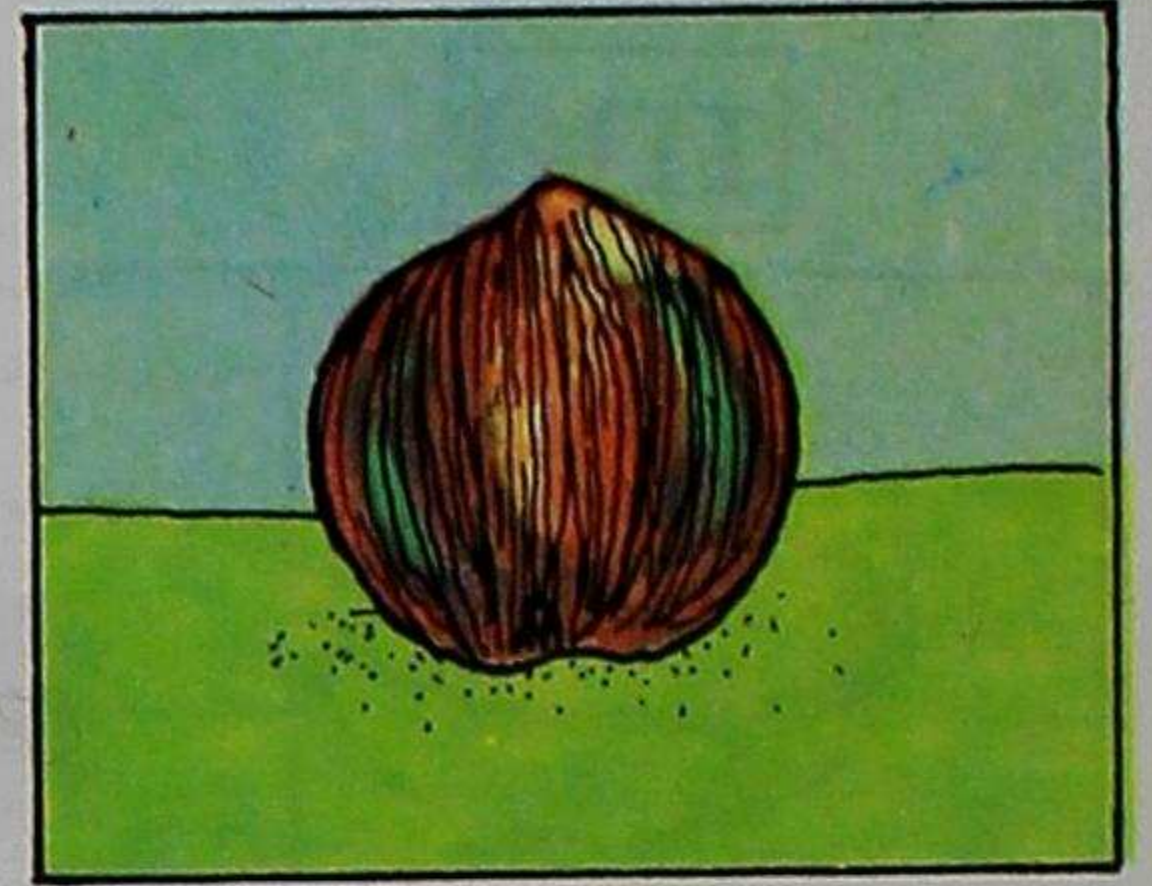

**tucti**

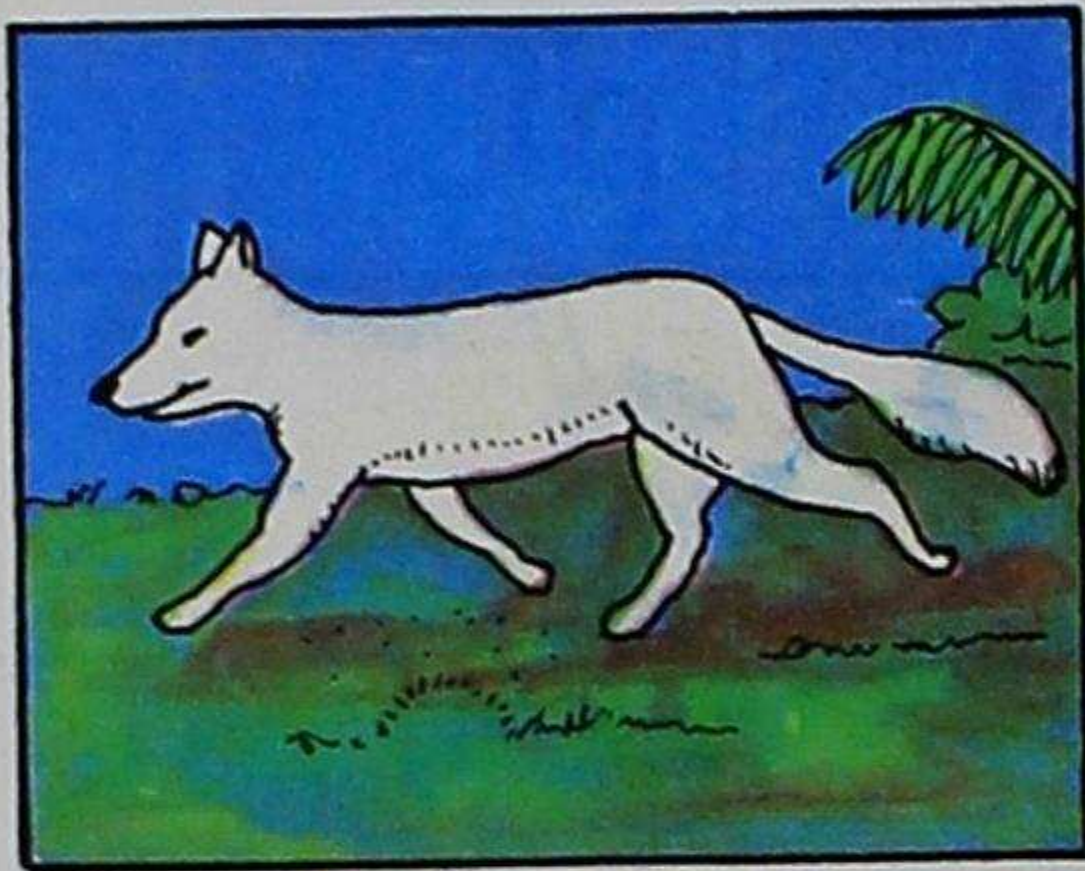

**atuc**

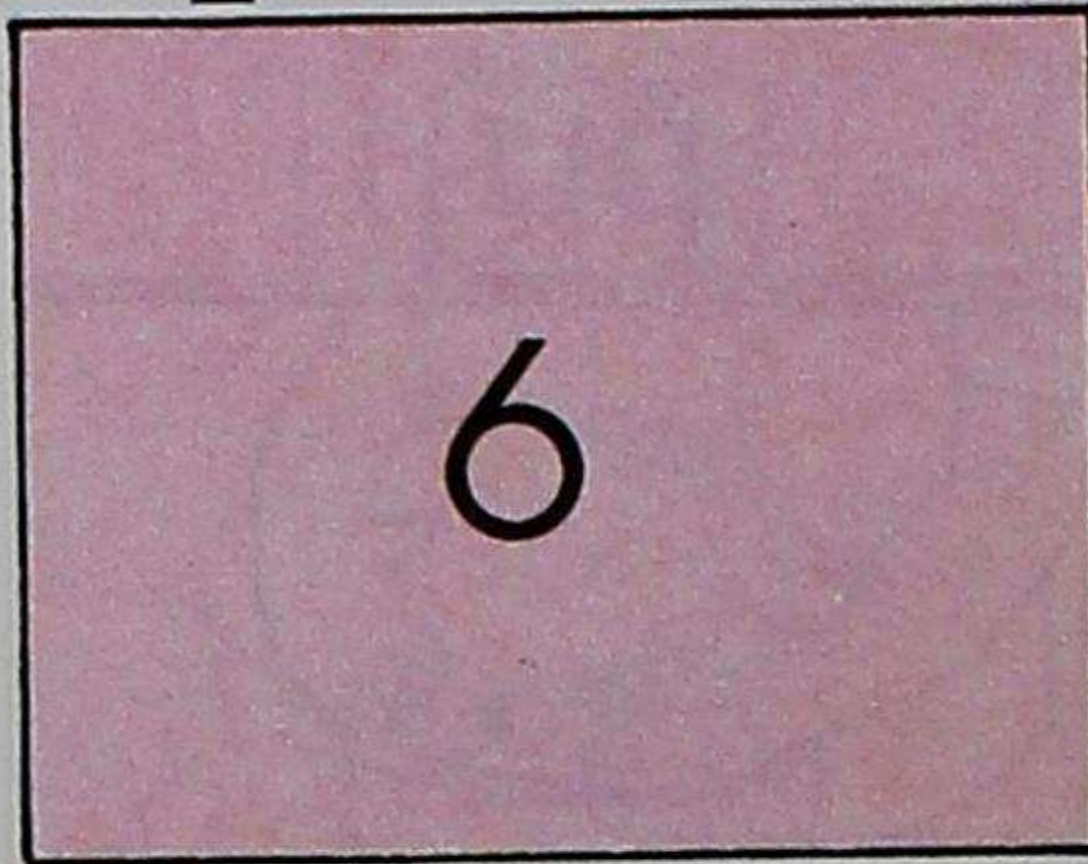

**sucta**

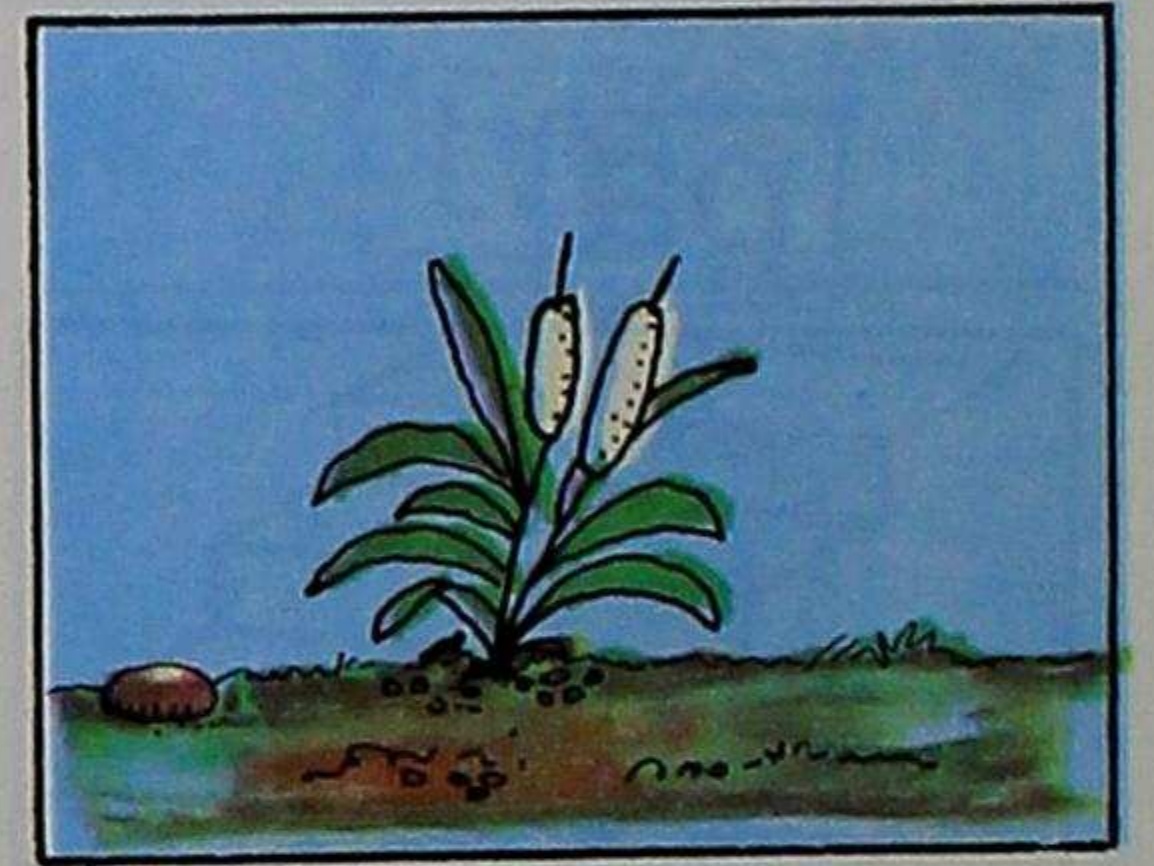

**sicsic**

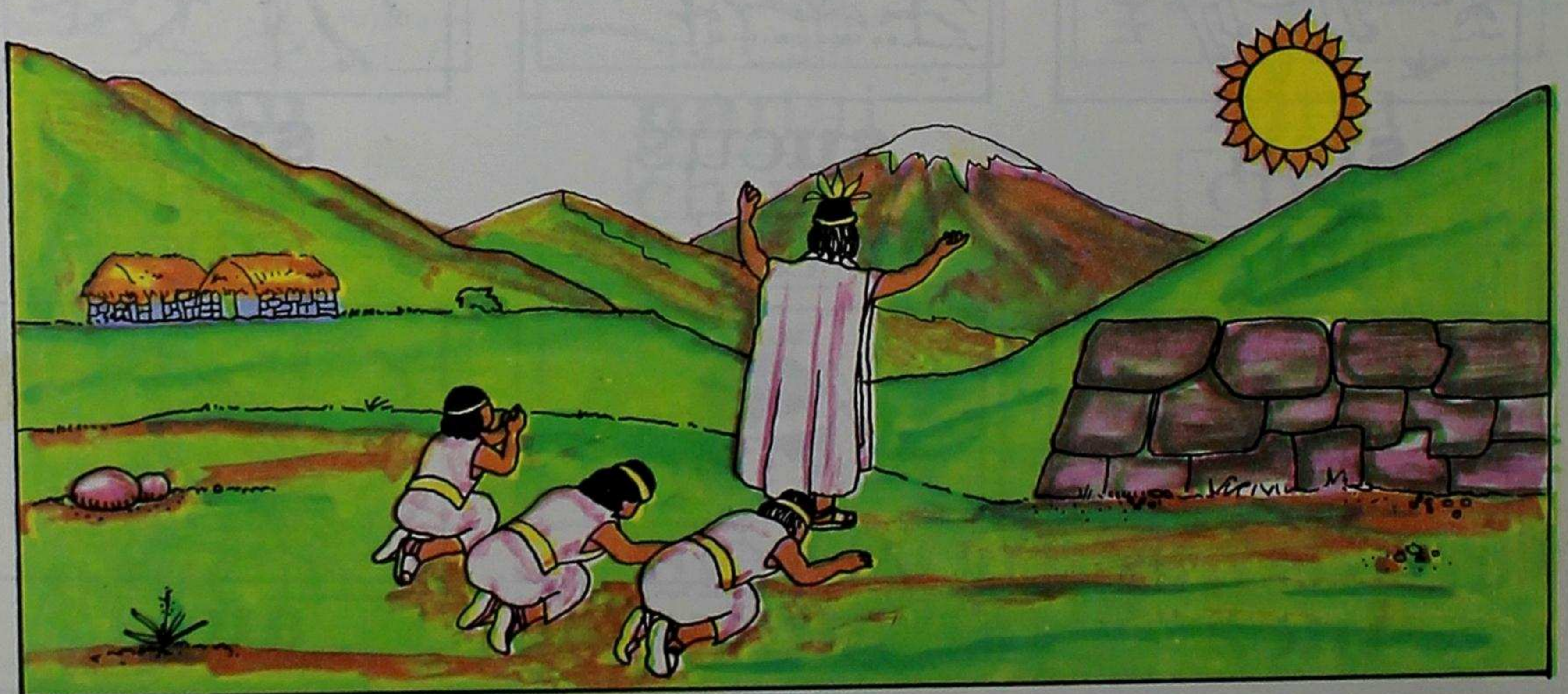
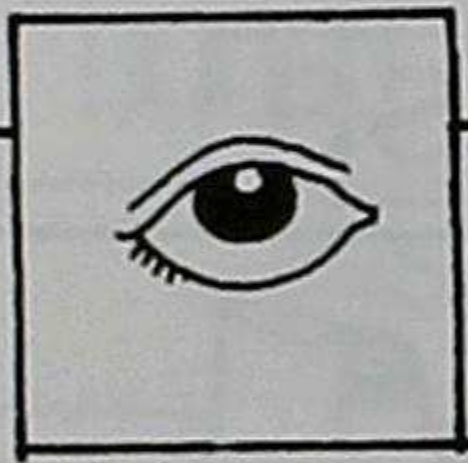

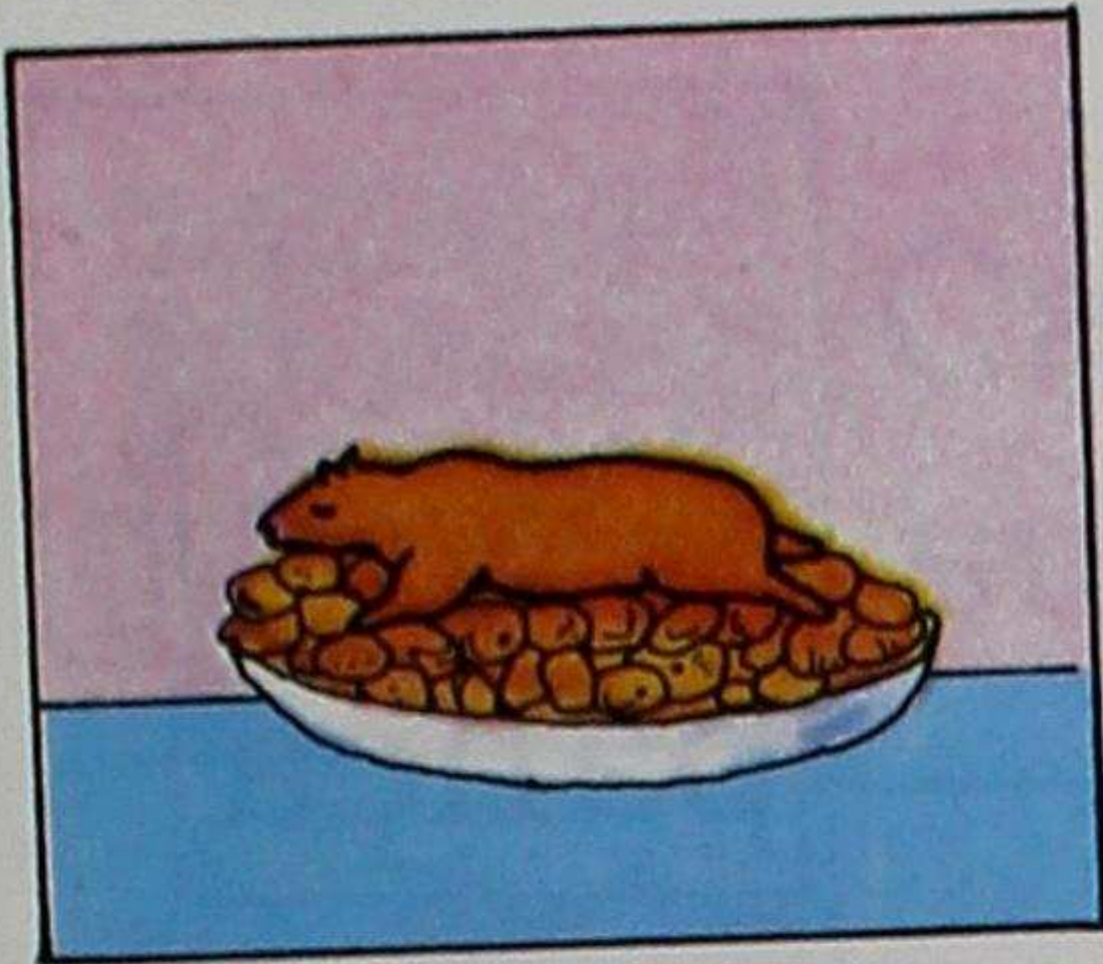
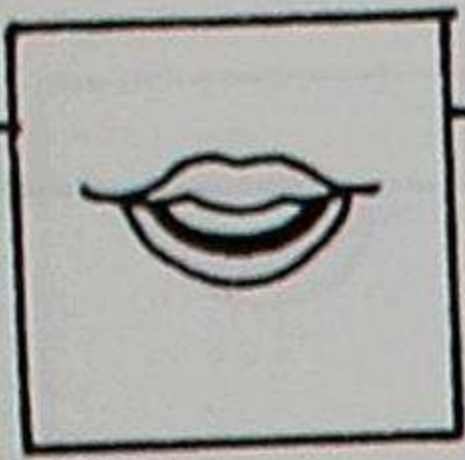

cui

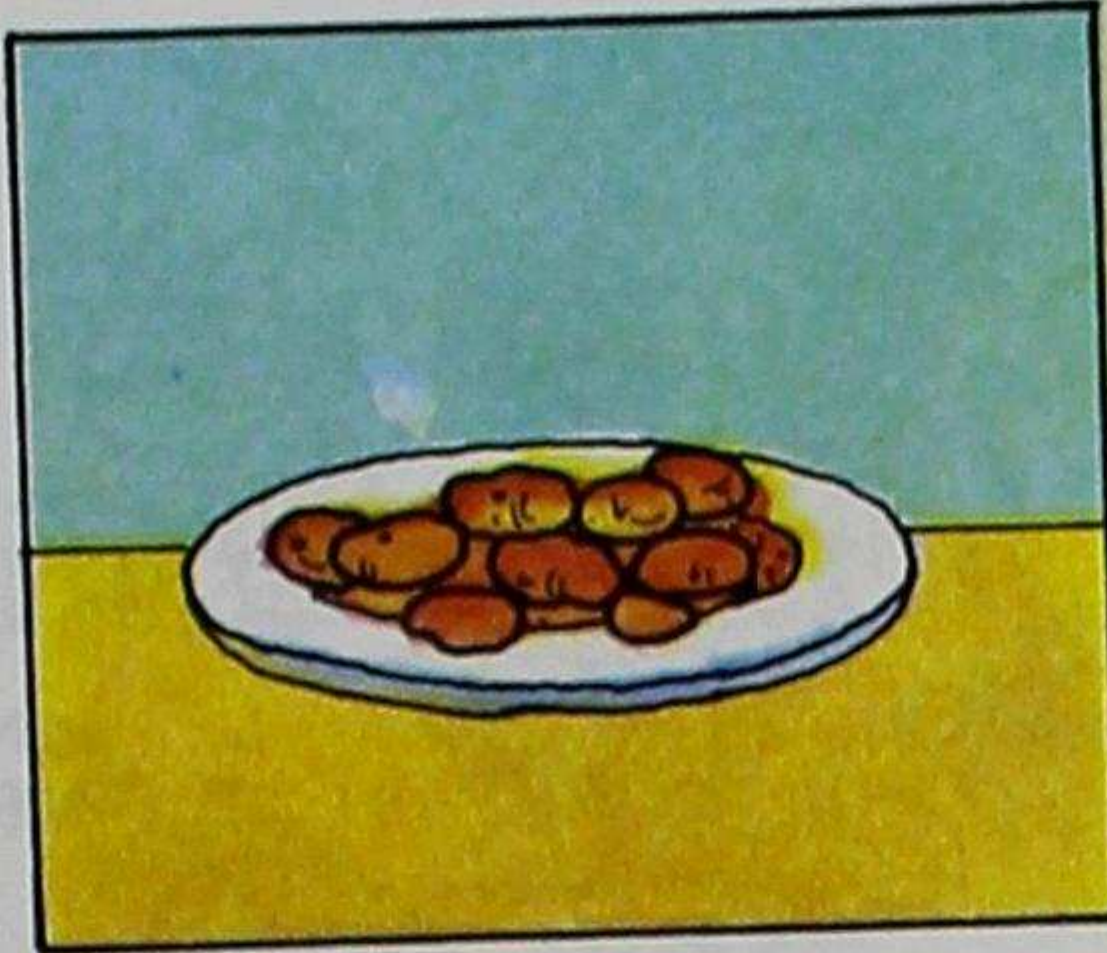

papa

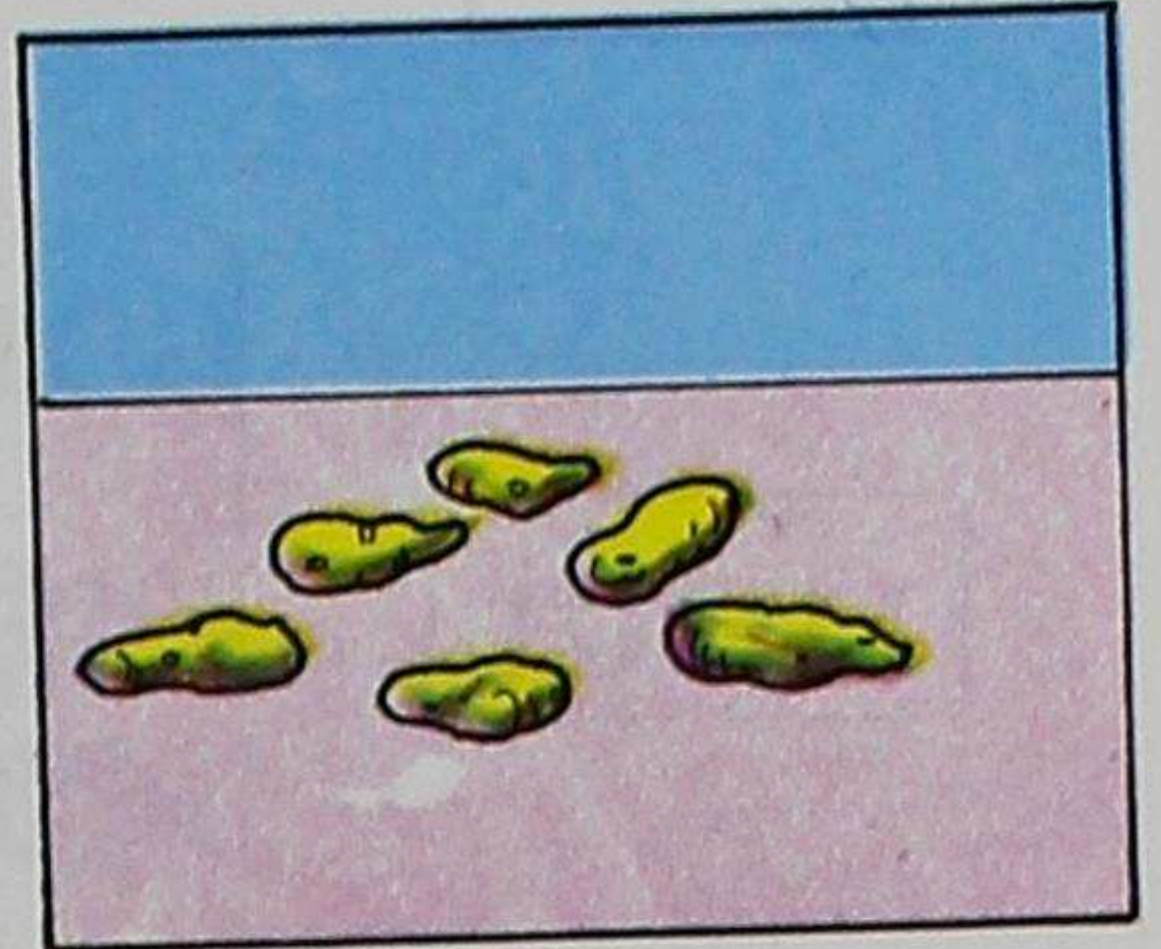

uca

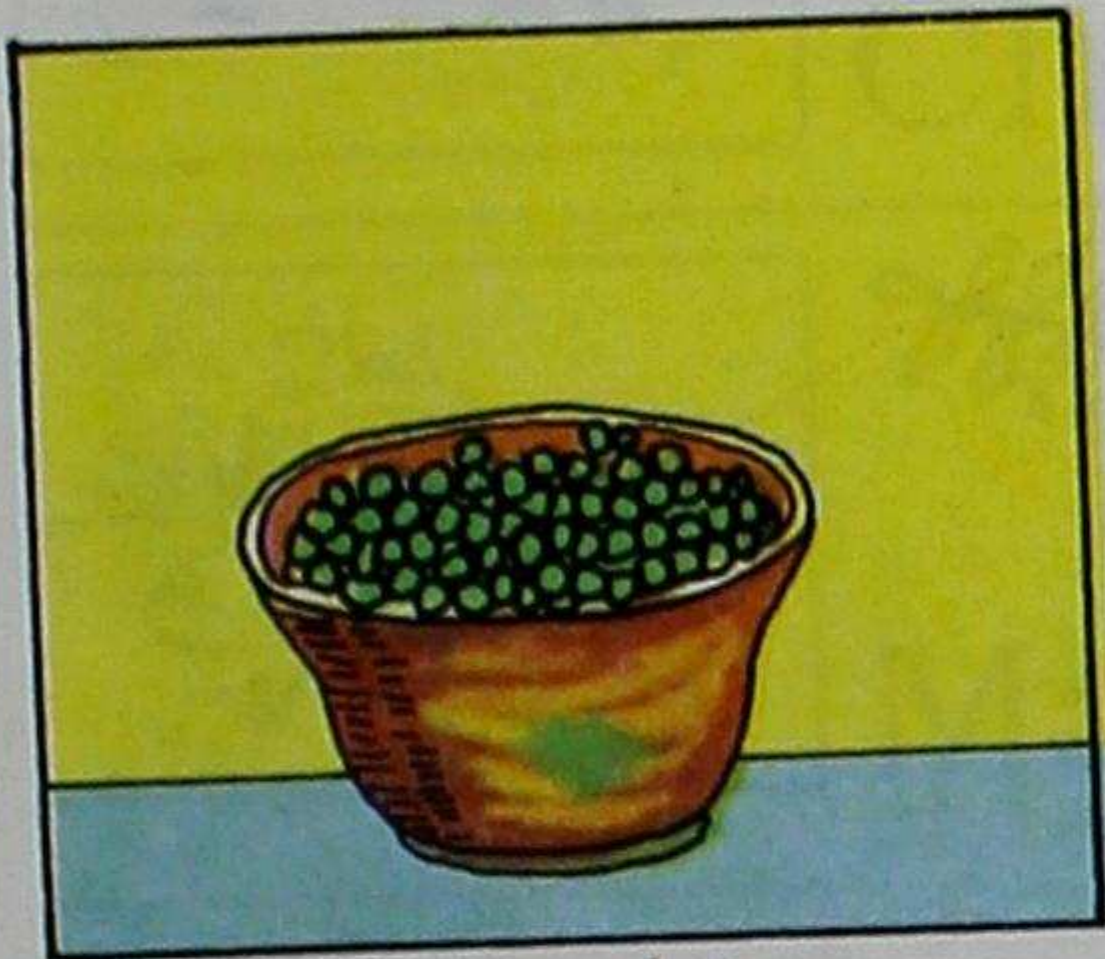

muti

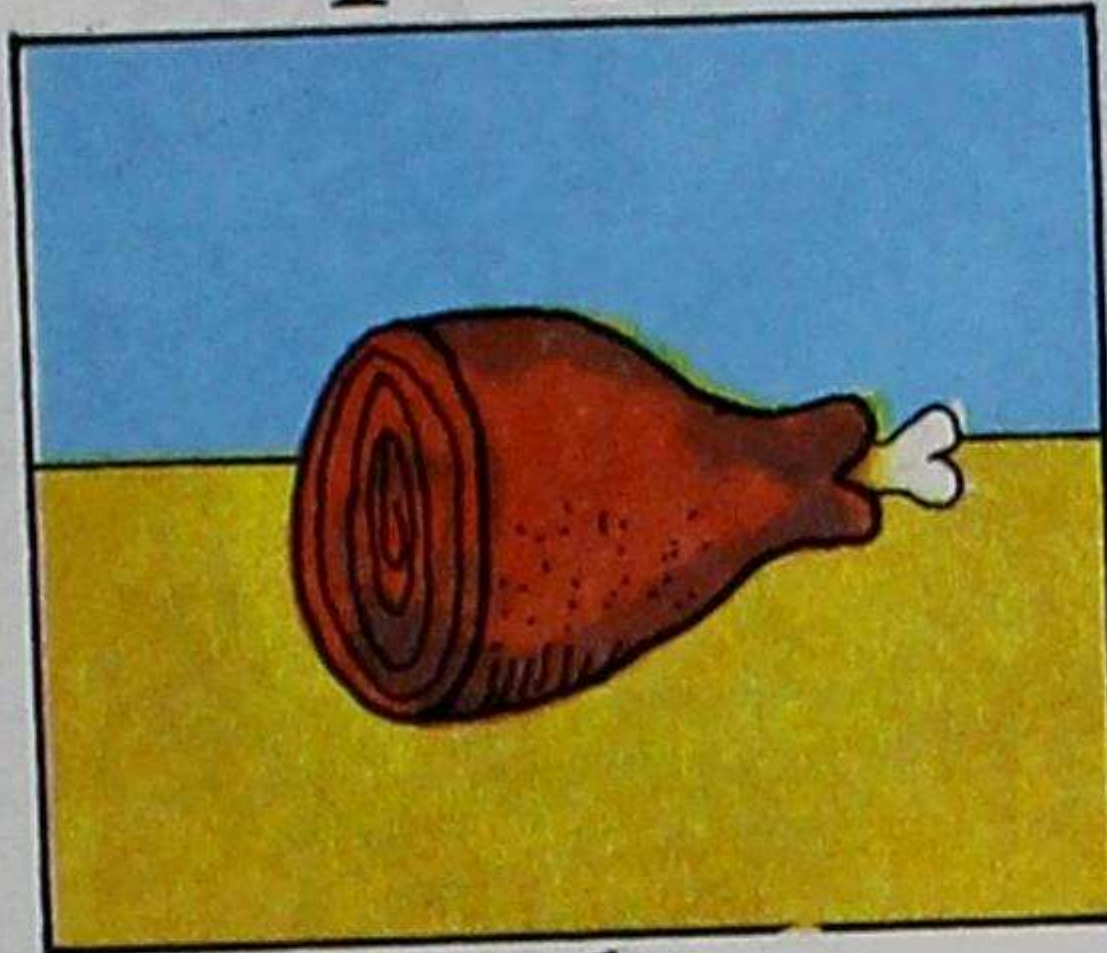

aicha

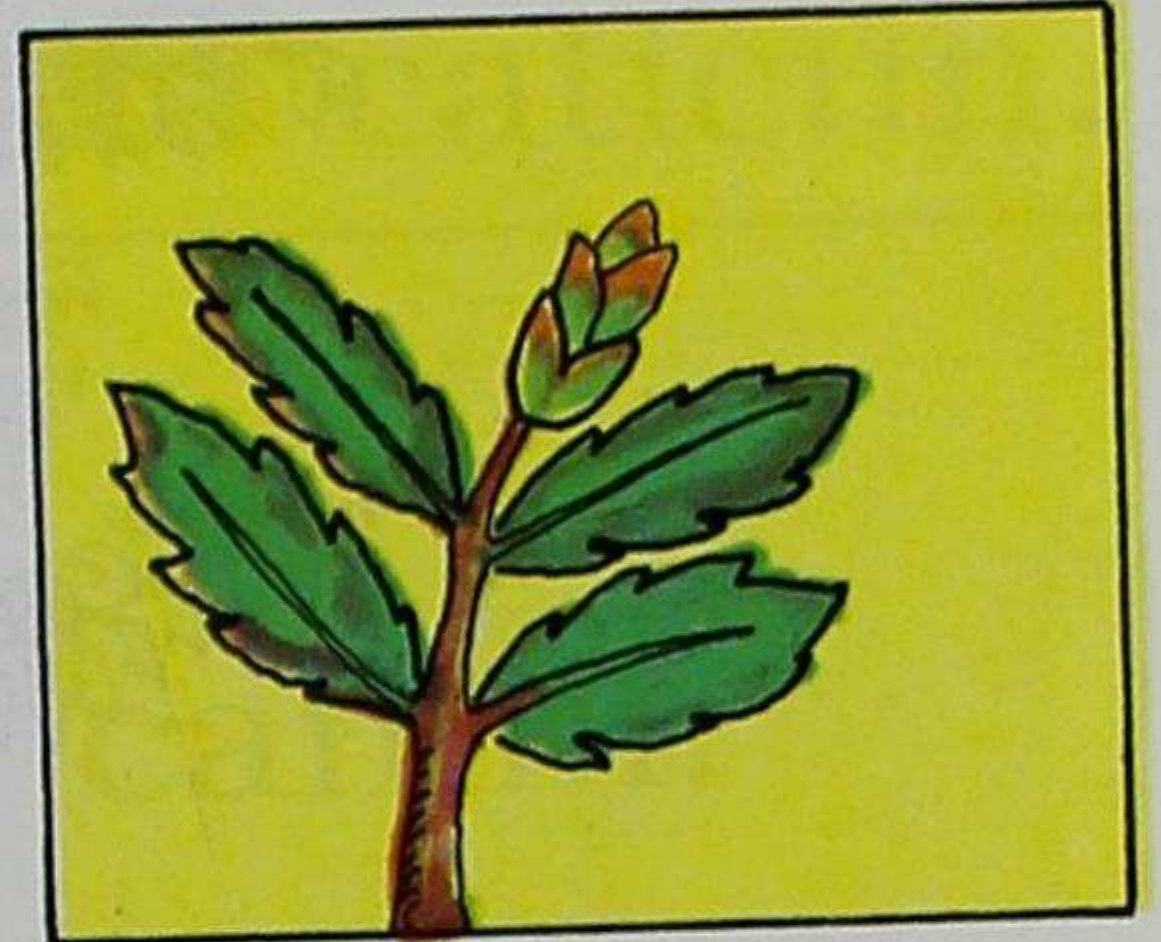

paicu

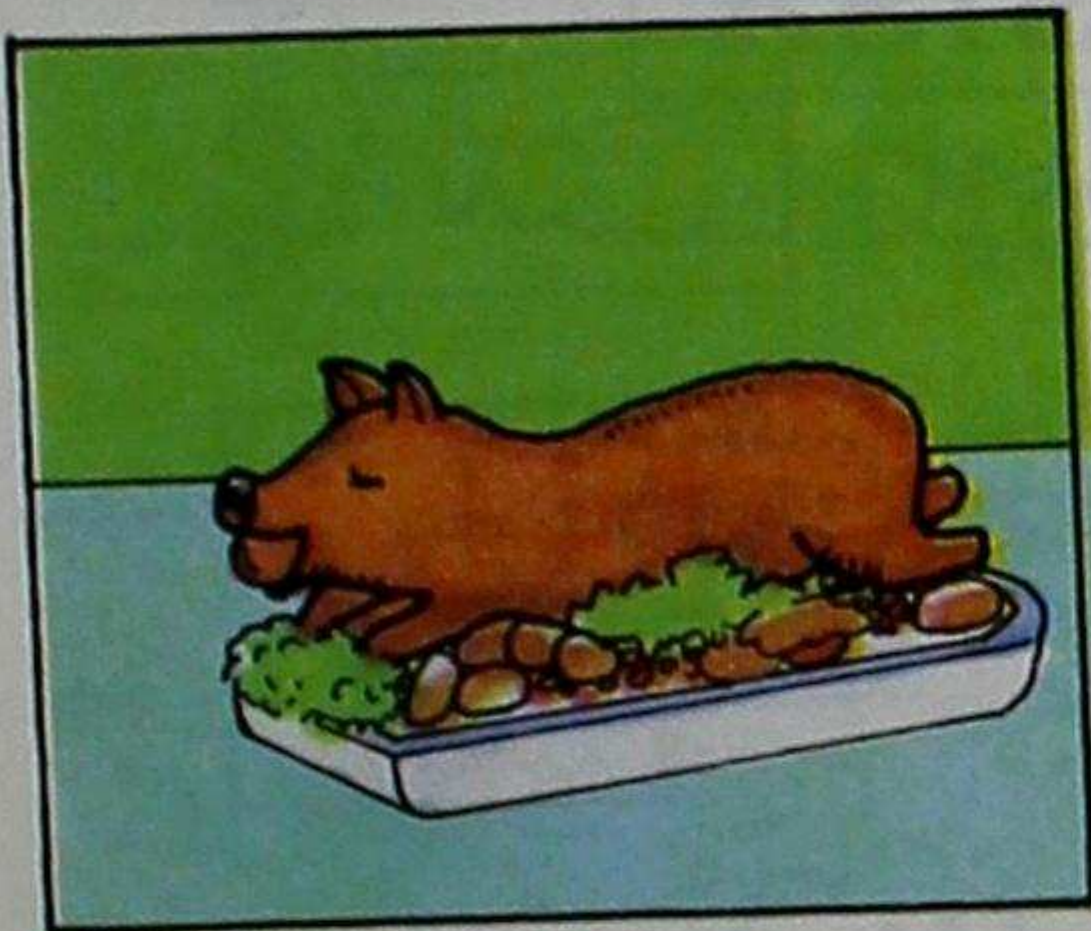

cuchi

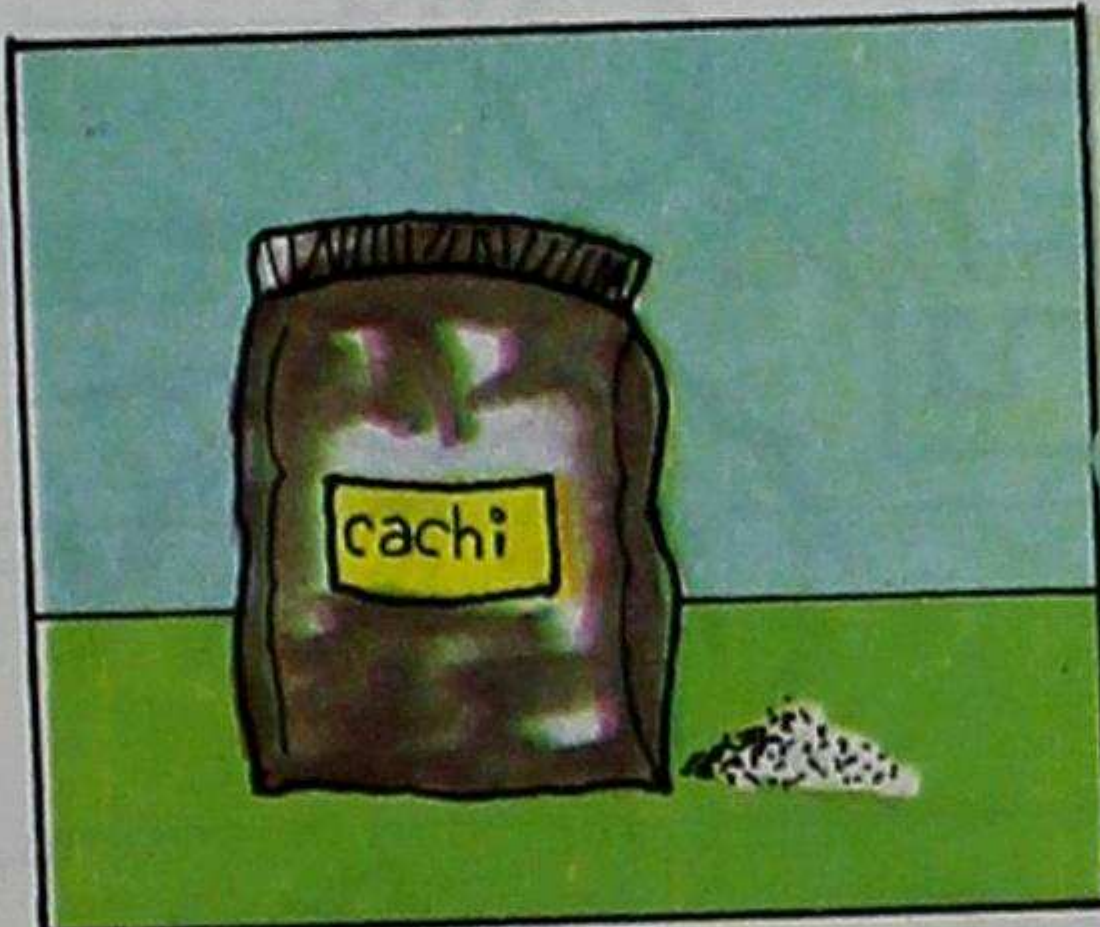

cachi

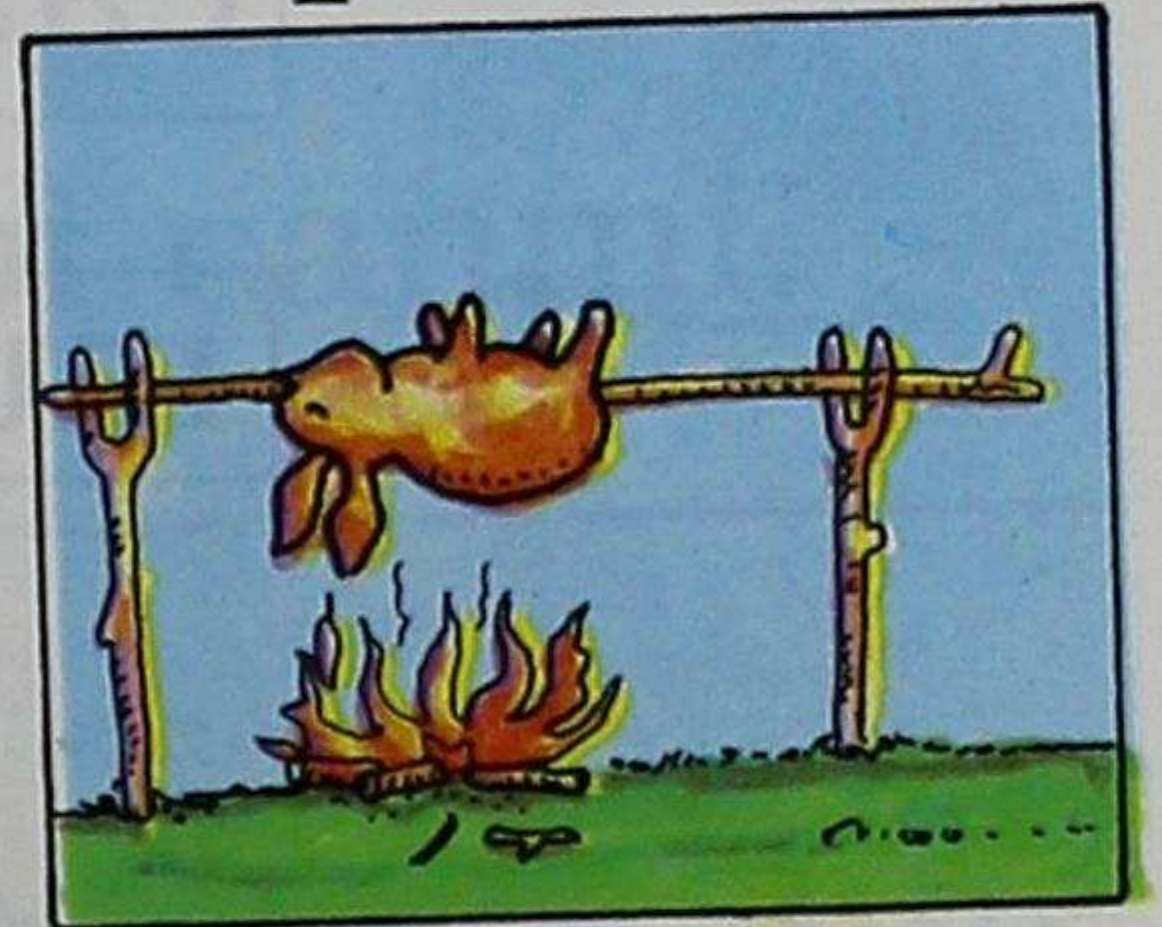

cunu

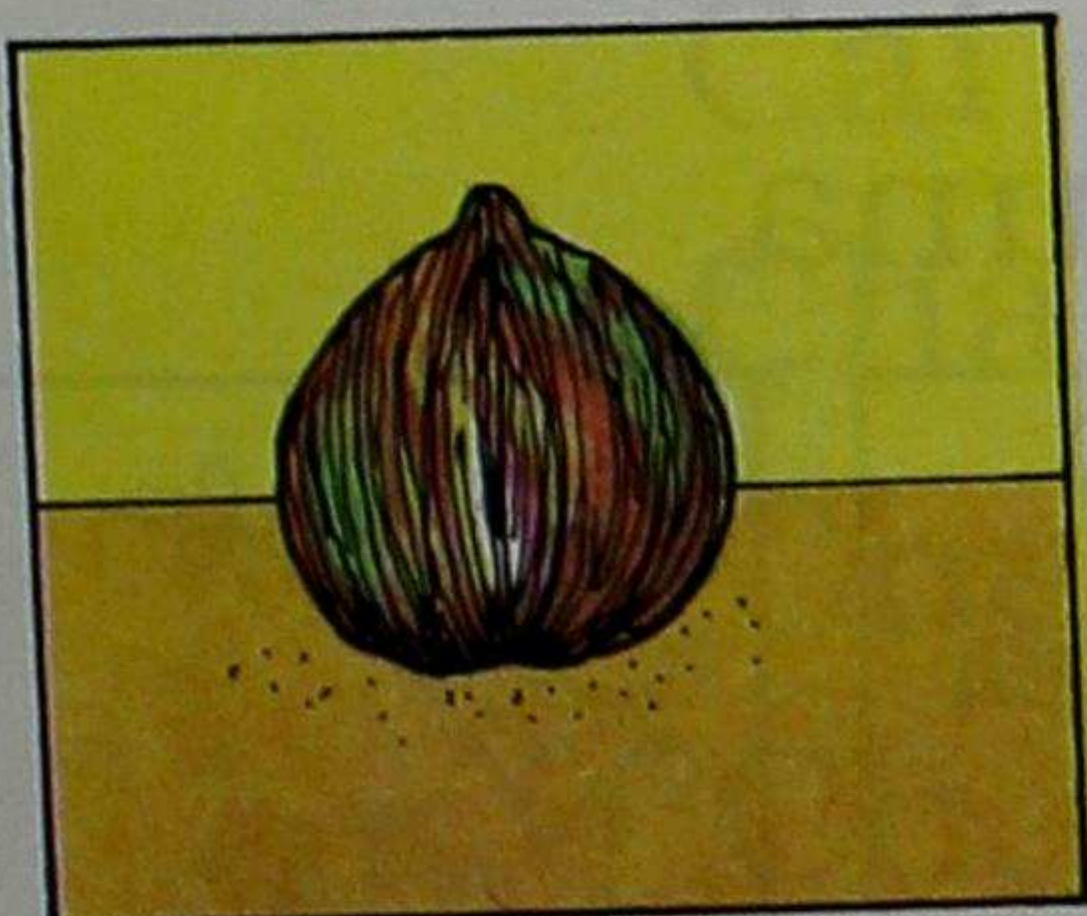

tucti

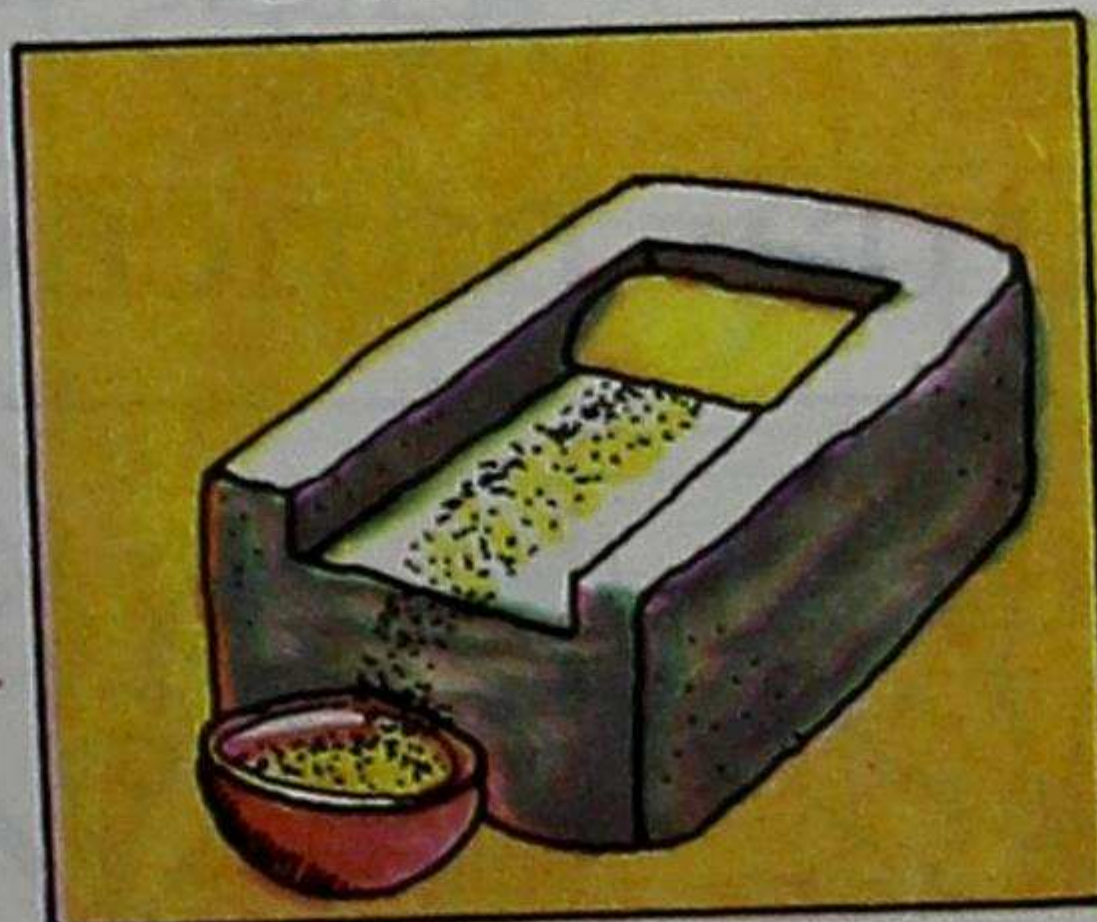

cuta

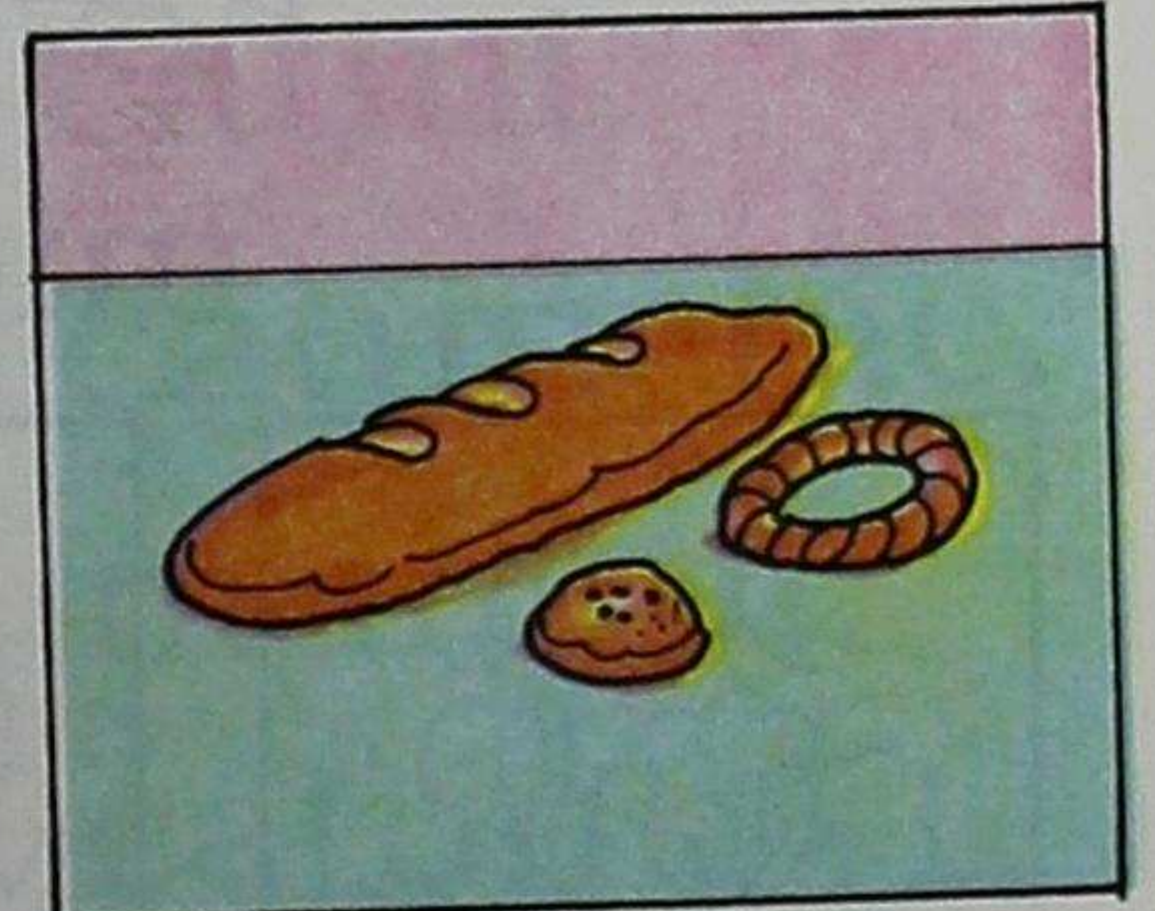

tanta

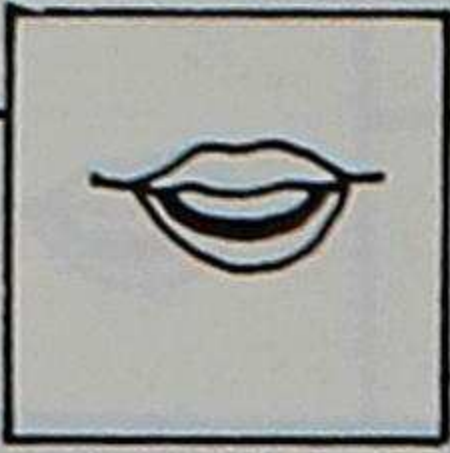

uma

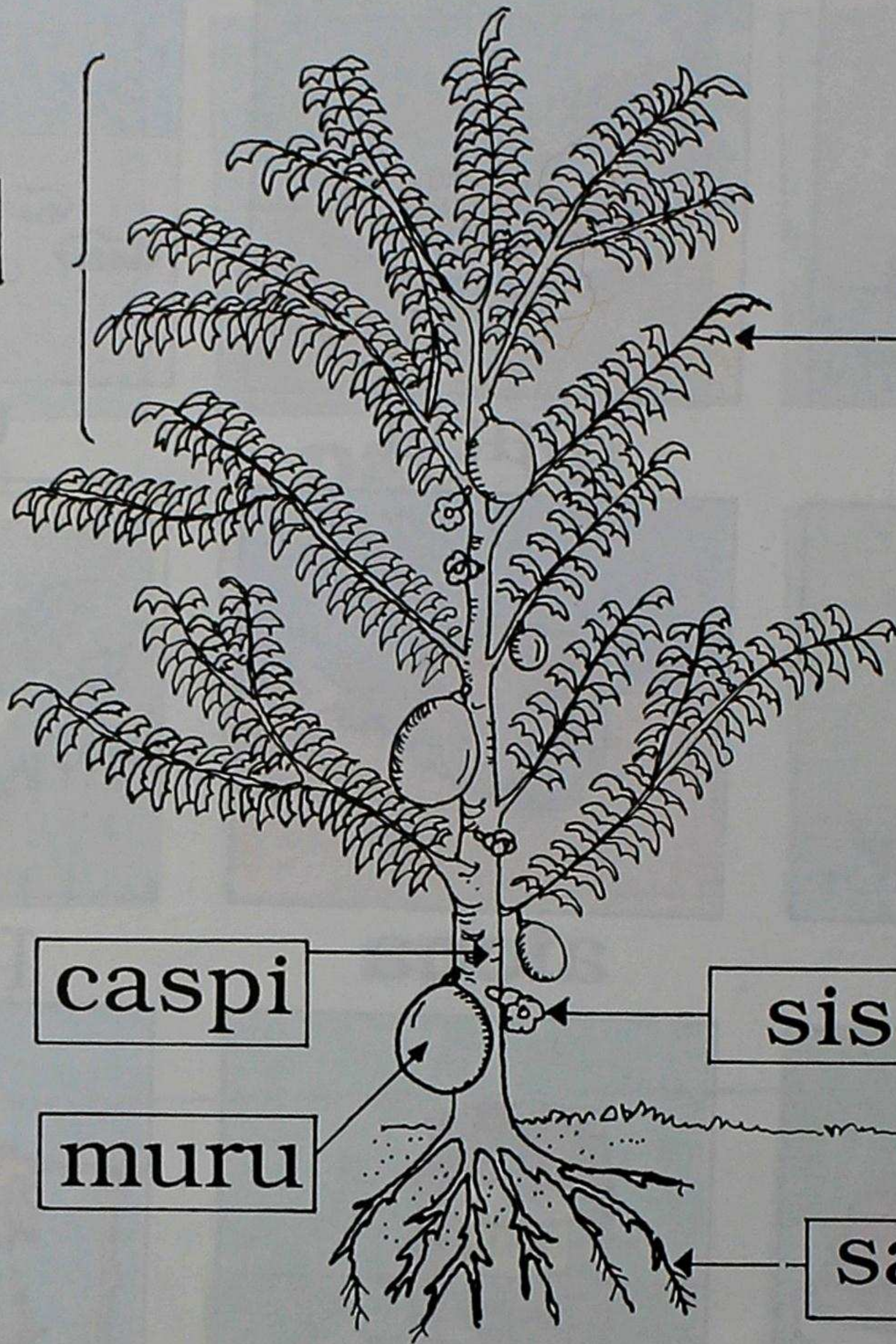

panca

caspi

sisu

muru

sapi

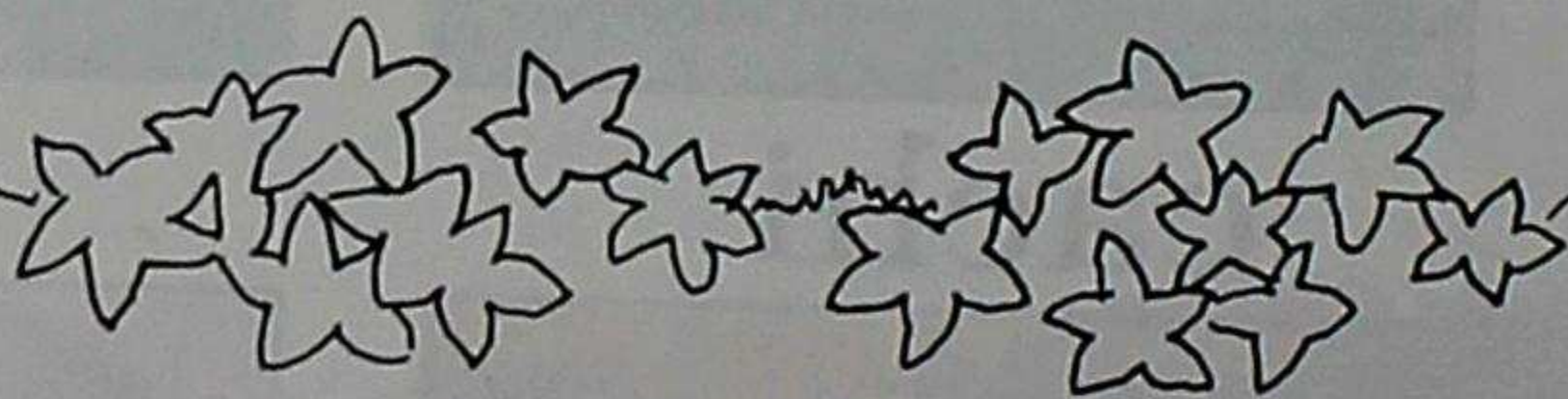

micuna pancacuna

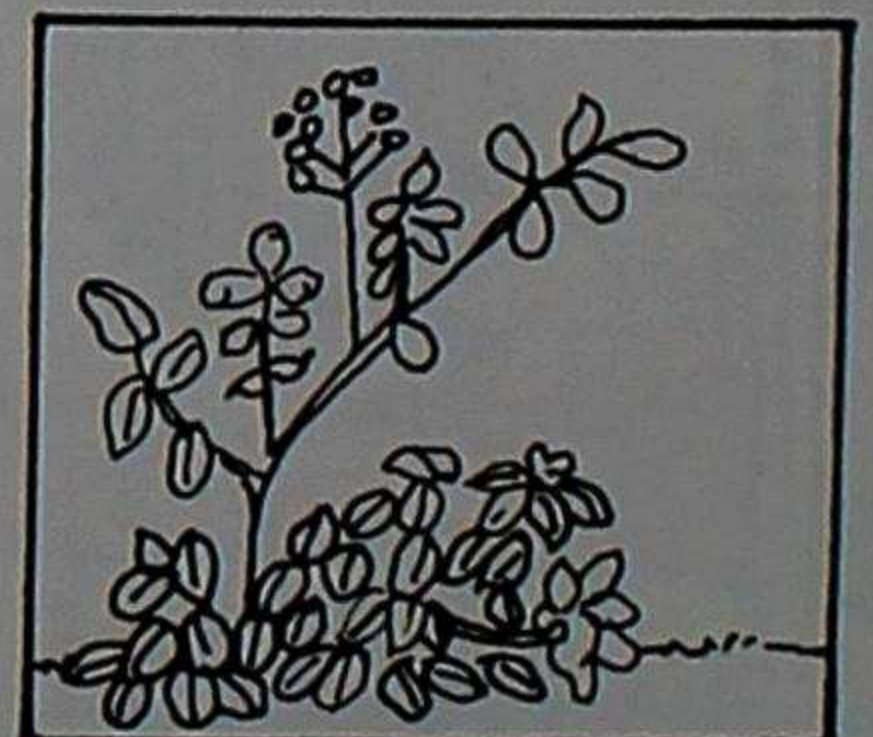
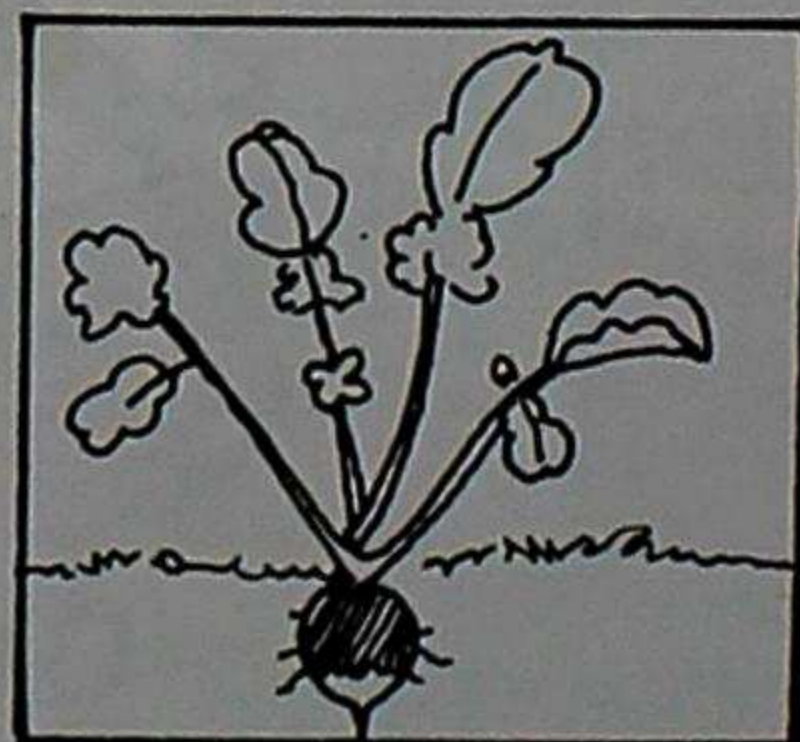
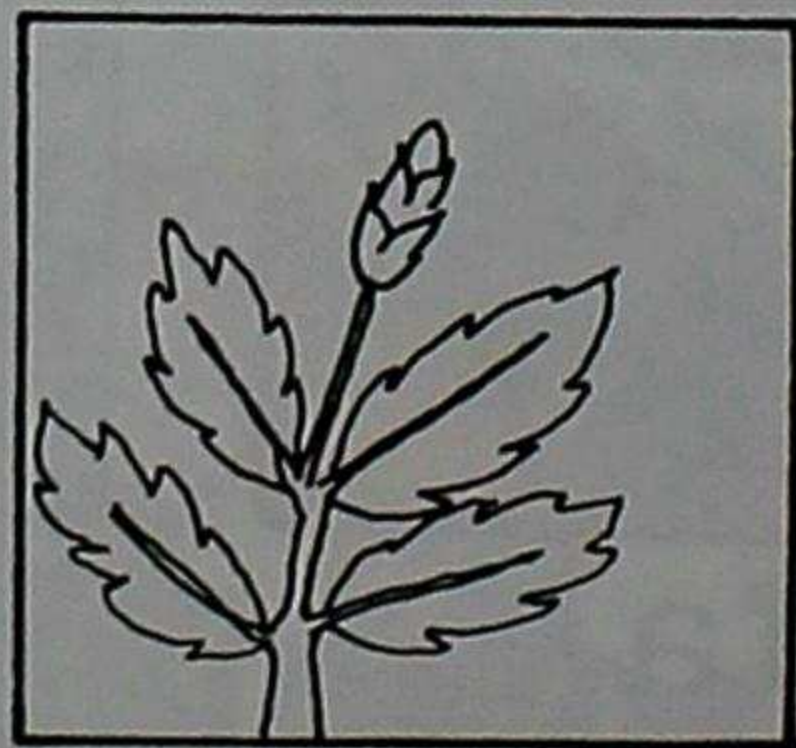
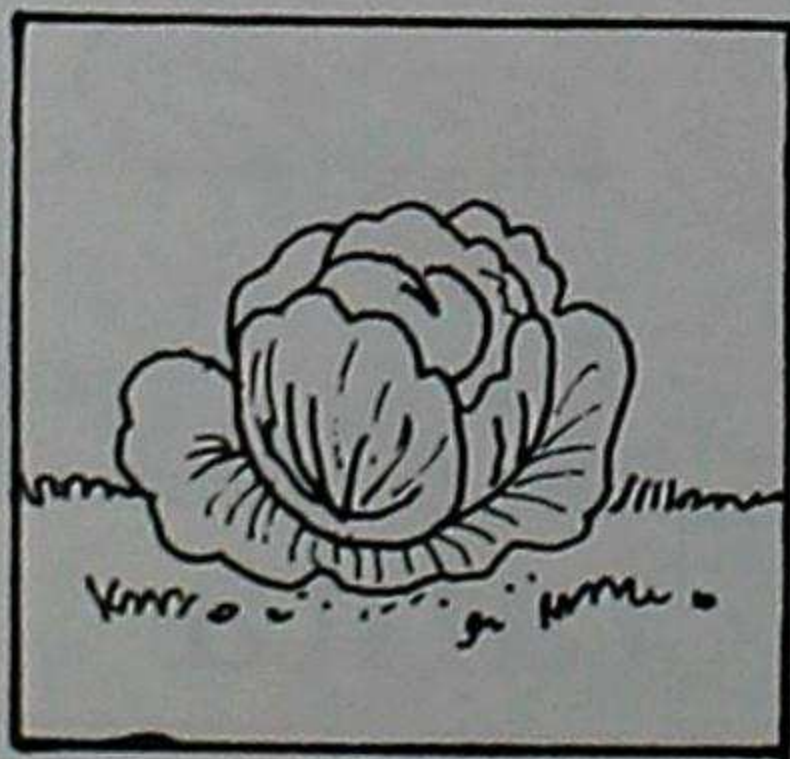

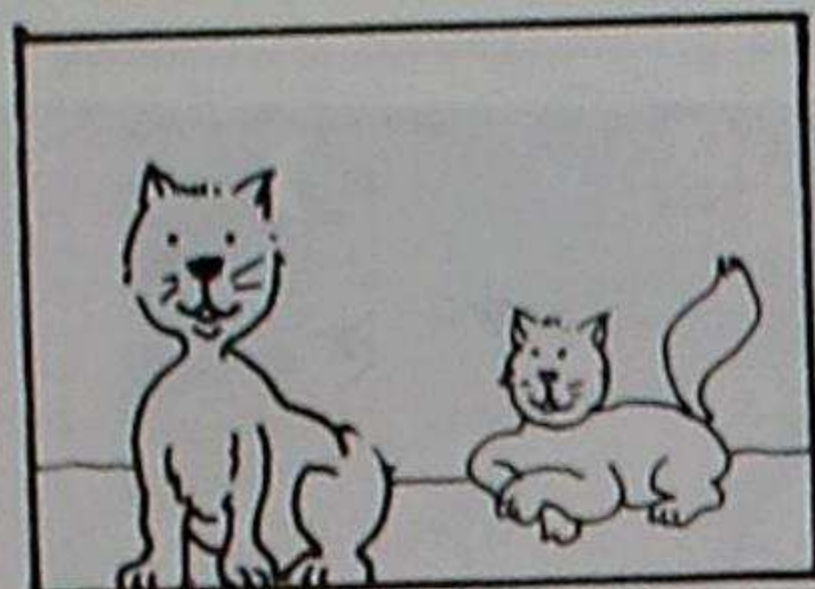
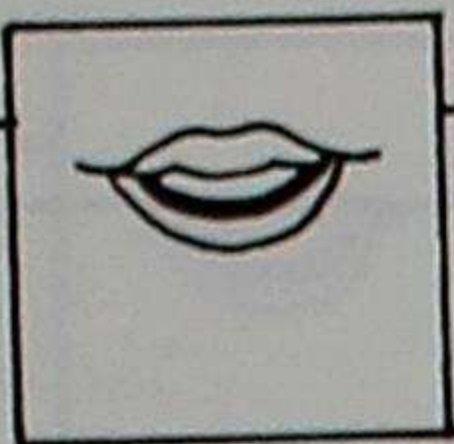

Cai puca misicuca  
sumacmi can.

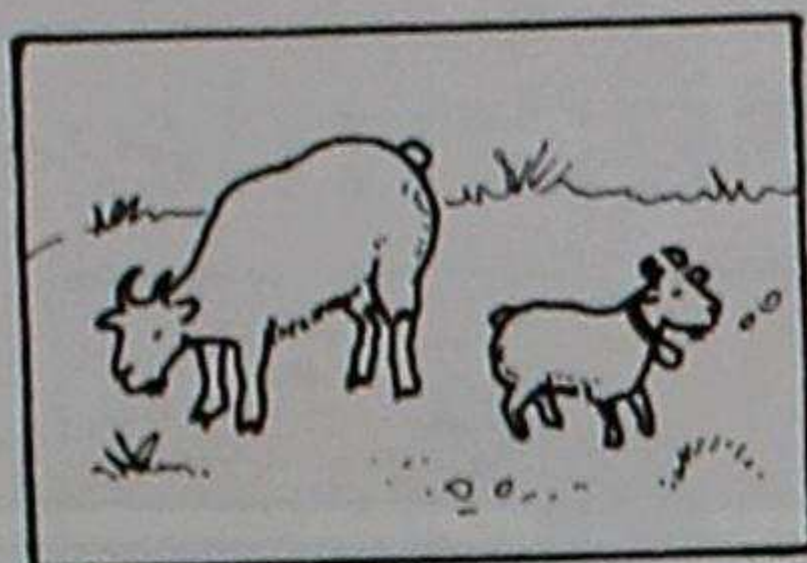

Chitacuca mamata caticun.

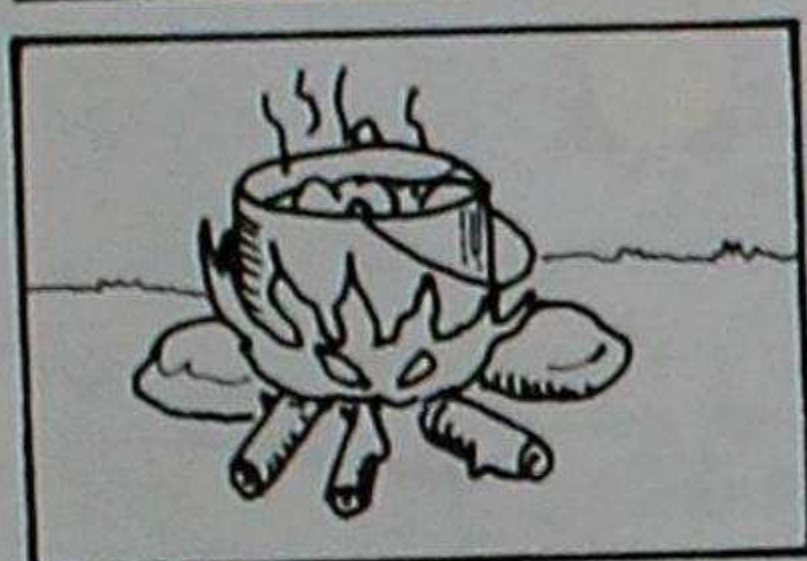

Mancaca ninapi canmi.

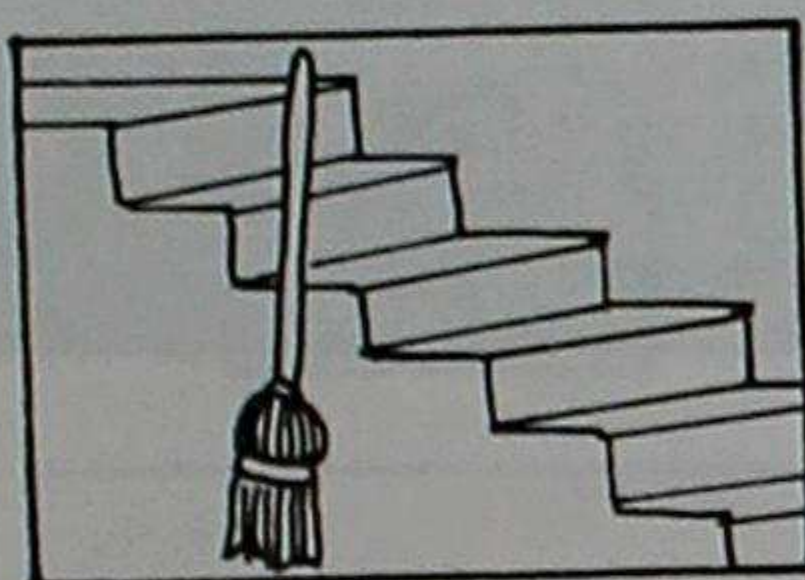

Pichanaca patapi canmi.

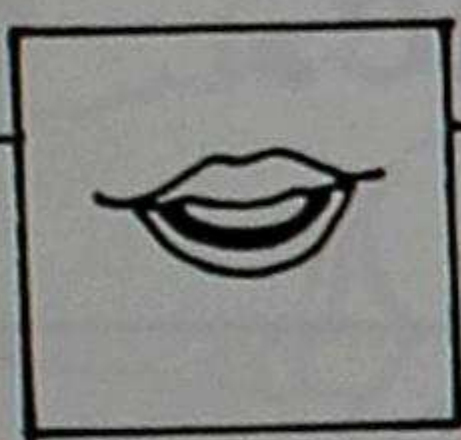

Cai

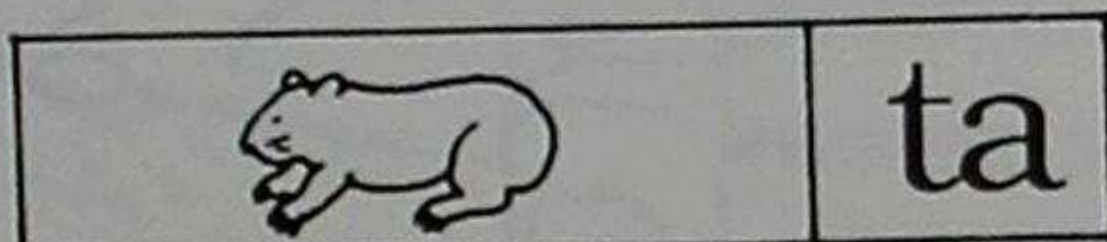

ta

micunchic.

Cai

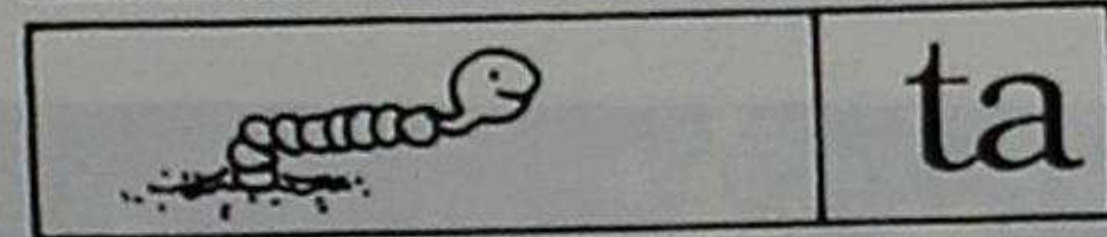

ta

catini.

Chai

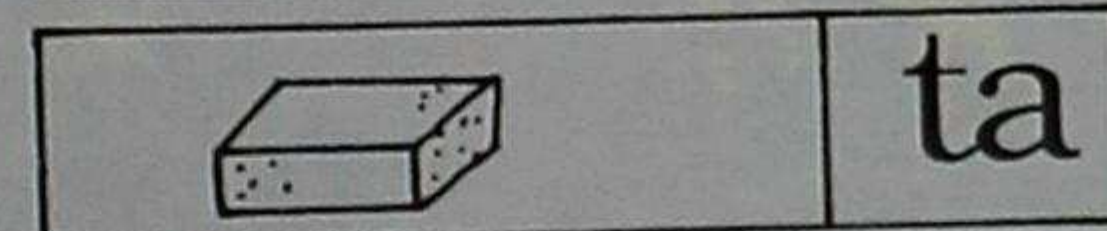

ta

catunchic.

Chai

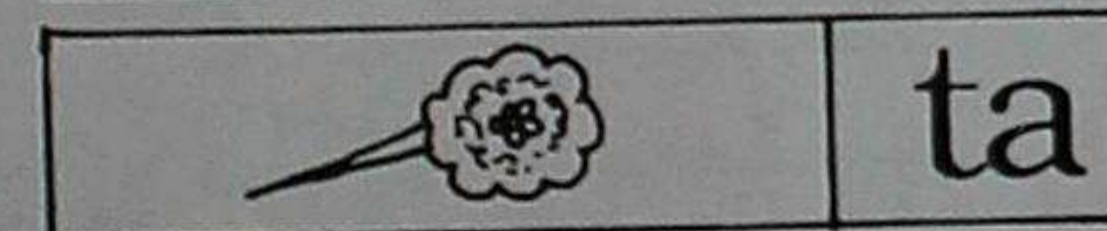

ta

munani.

Chai

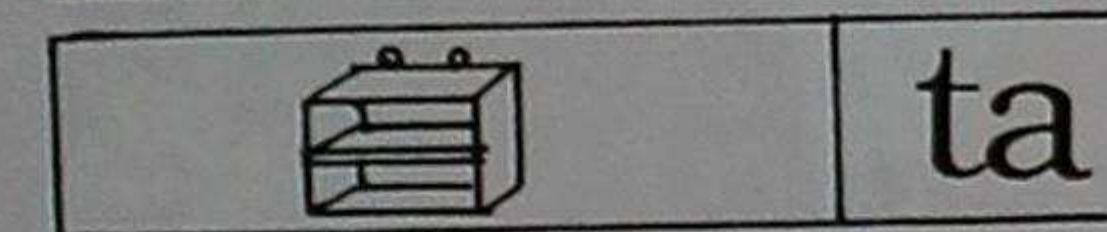

ta

catuni.

Chai

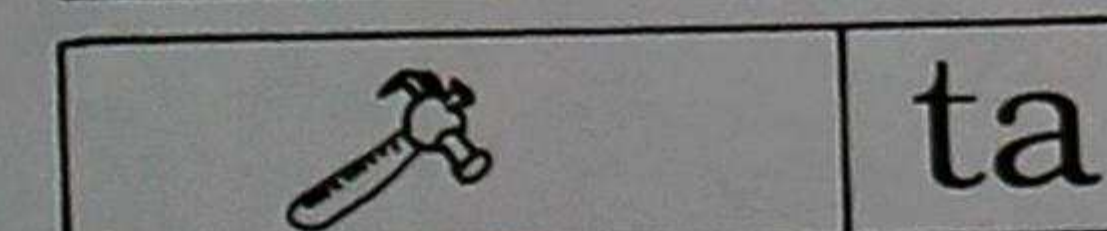

ta

apamupai.

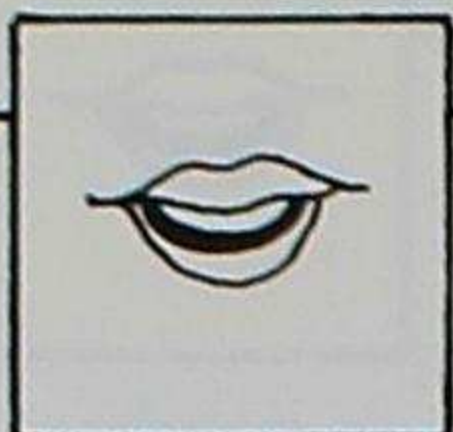

Tutami puñunchic.  
Punchami michinchic.

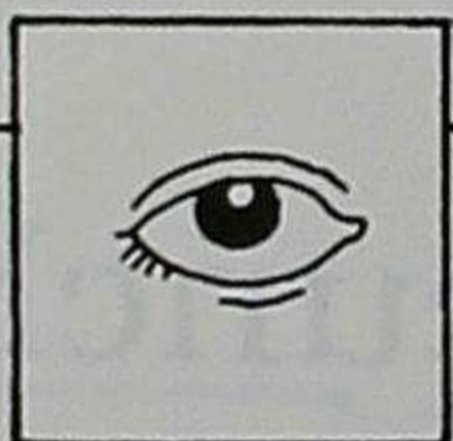

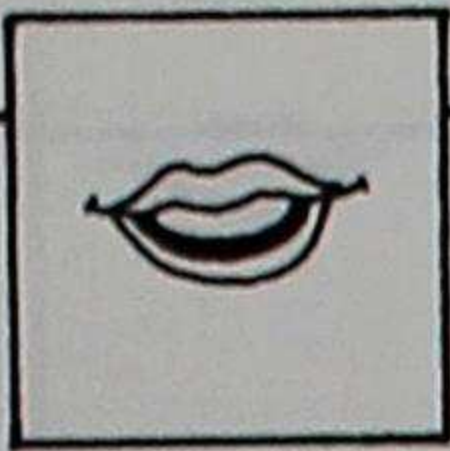

sincasapa



cuncasapa



umasapa

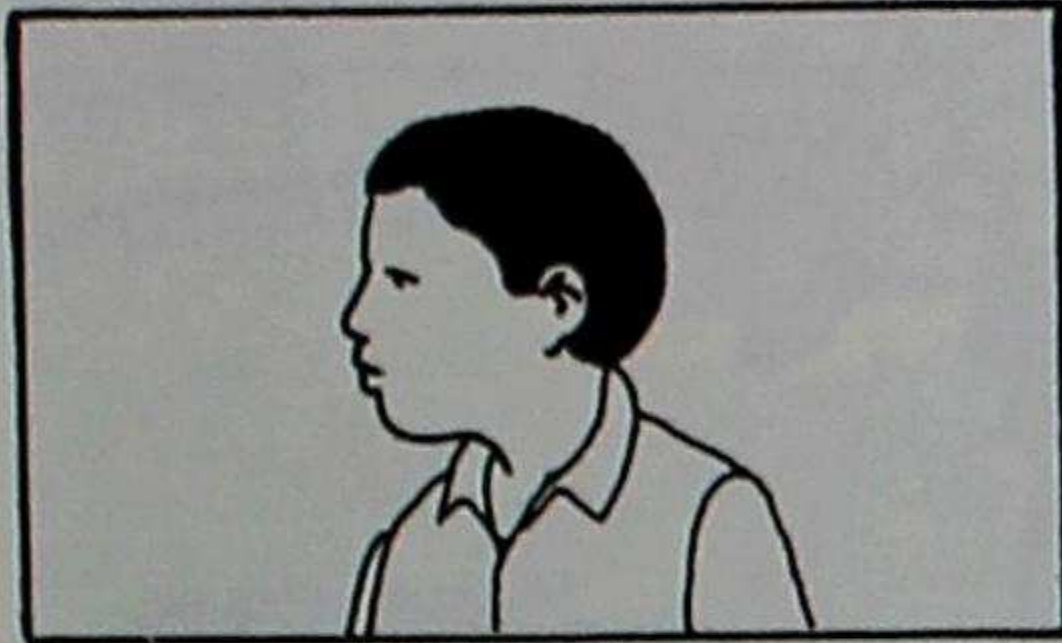

sincacu



cuncacu

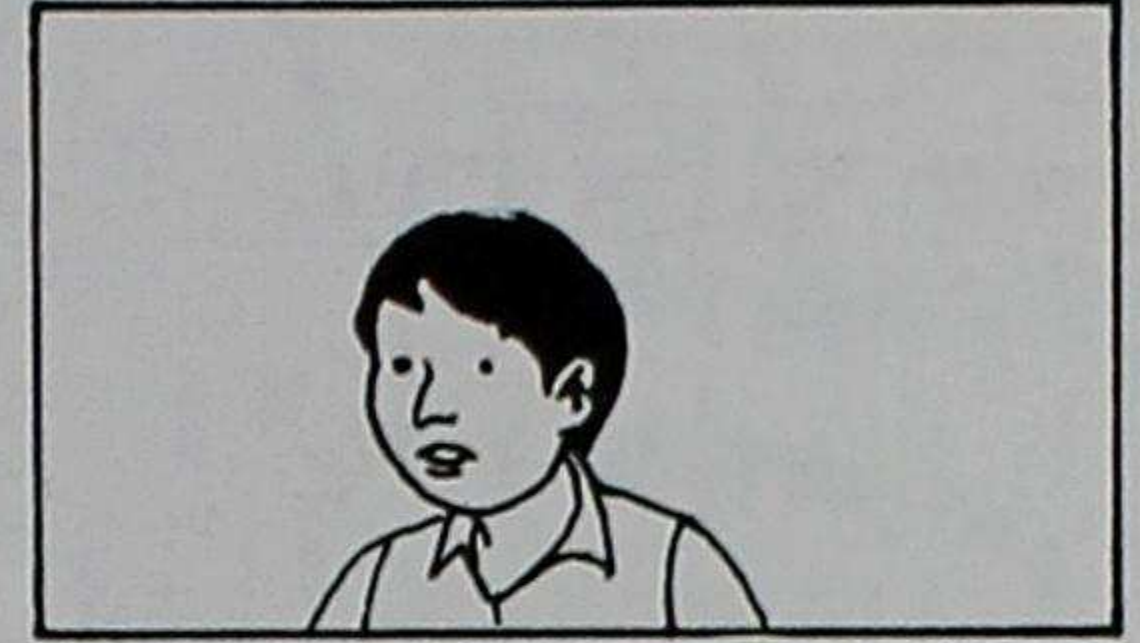

umacu

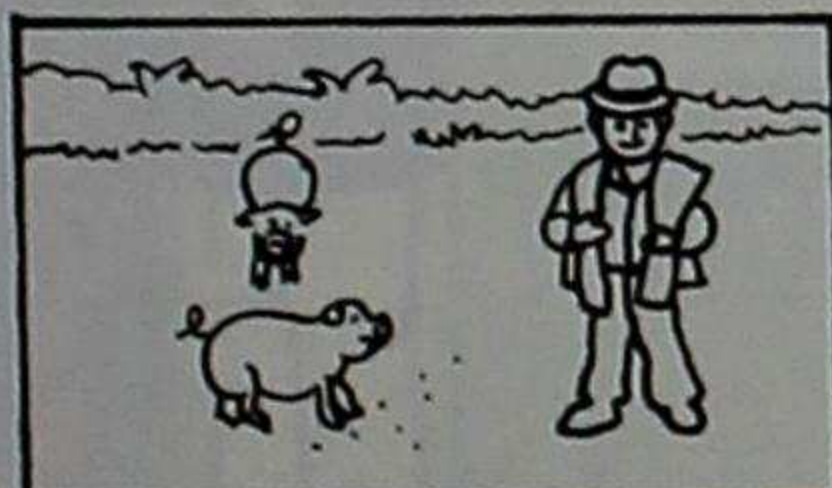
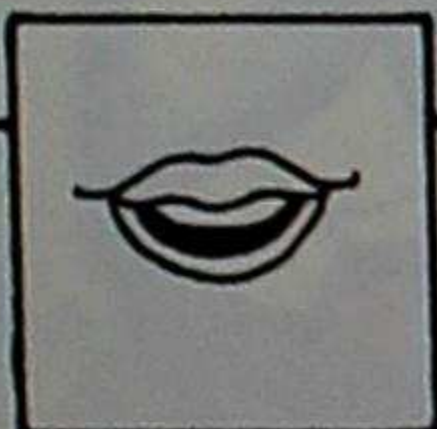
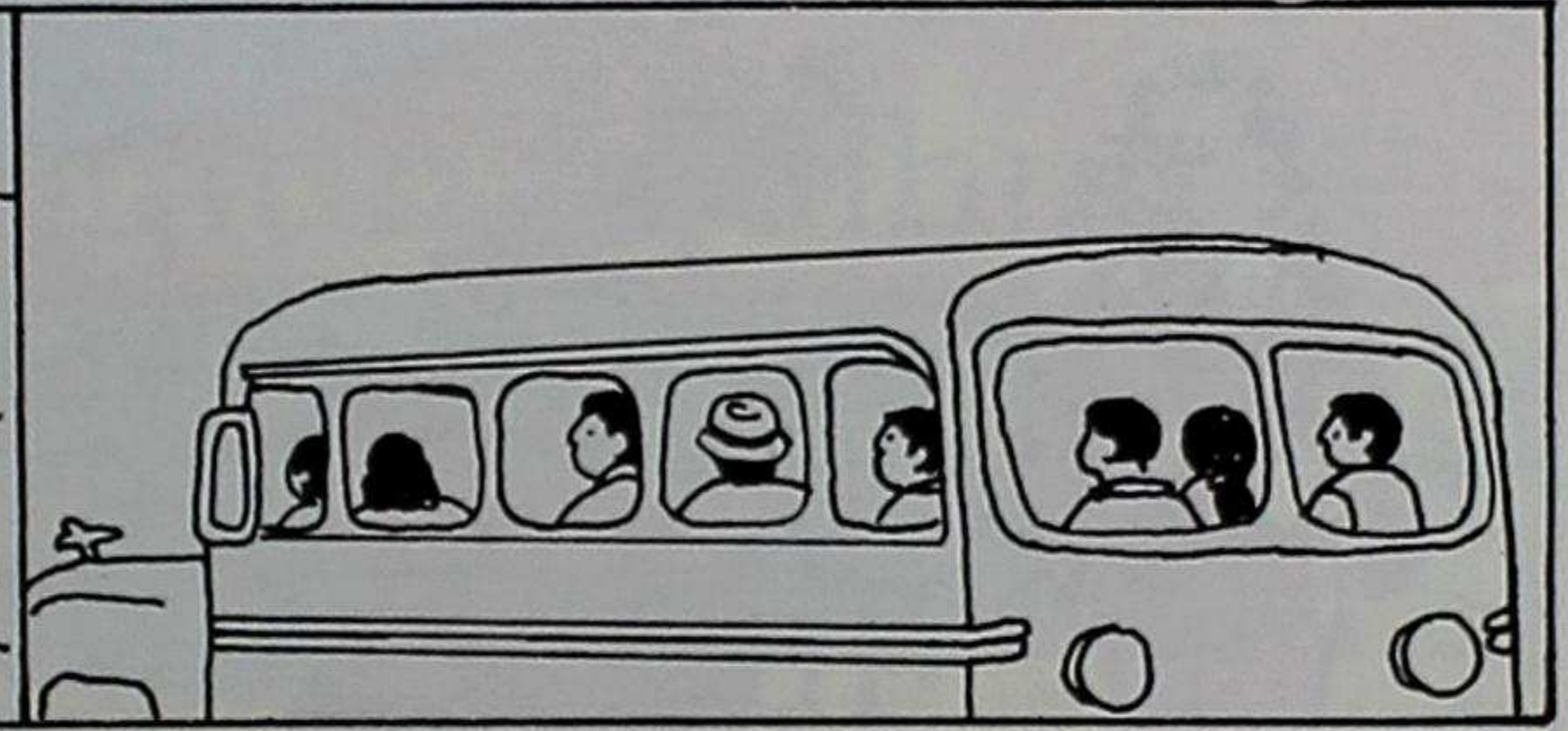
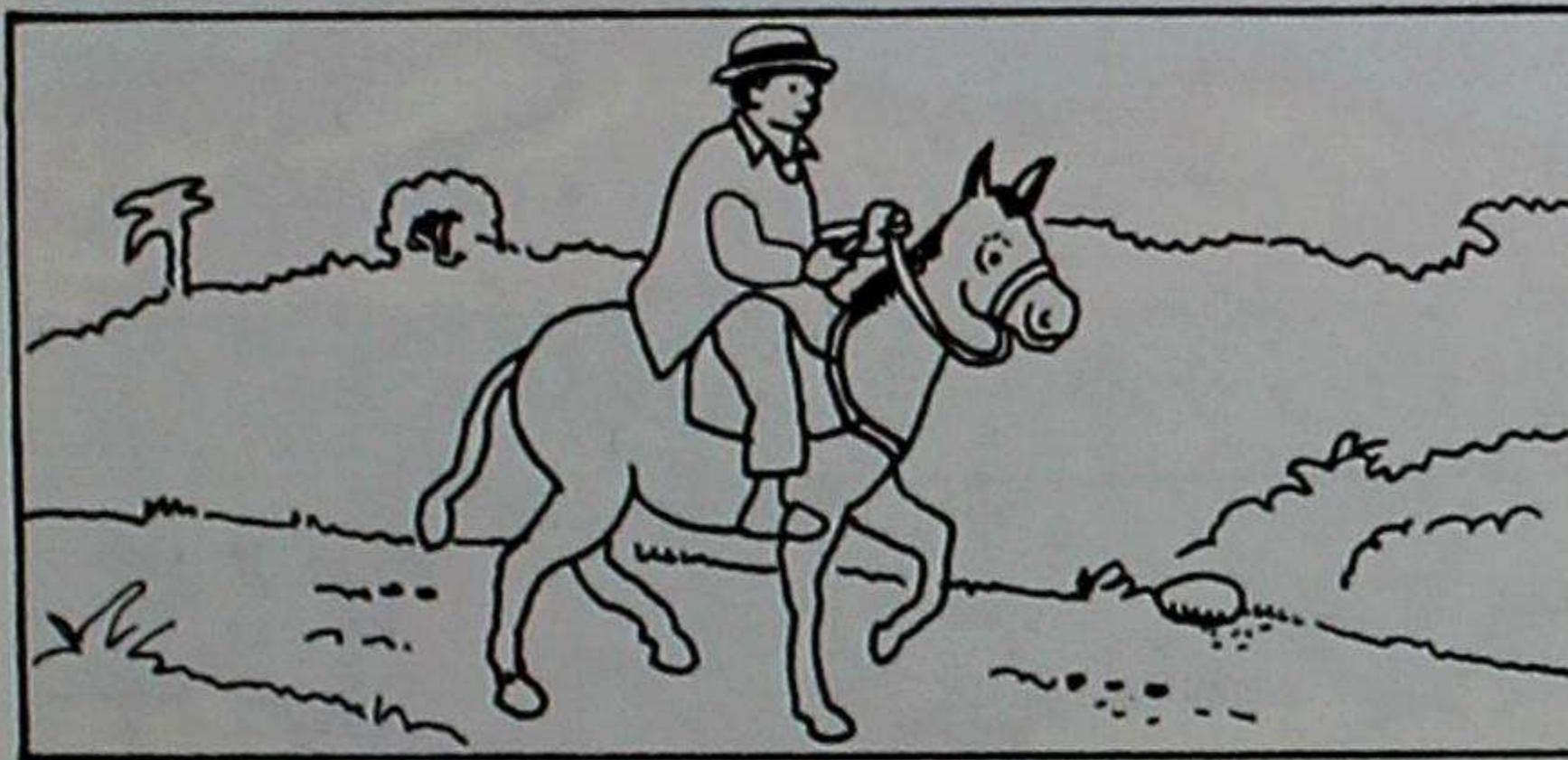
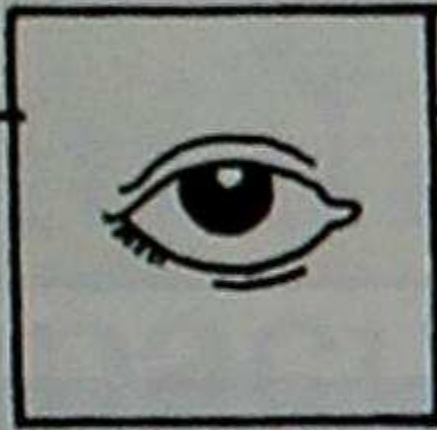

Paica  
cuchicamacmi can.

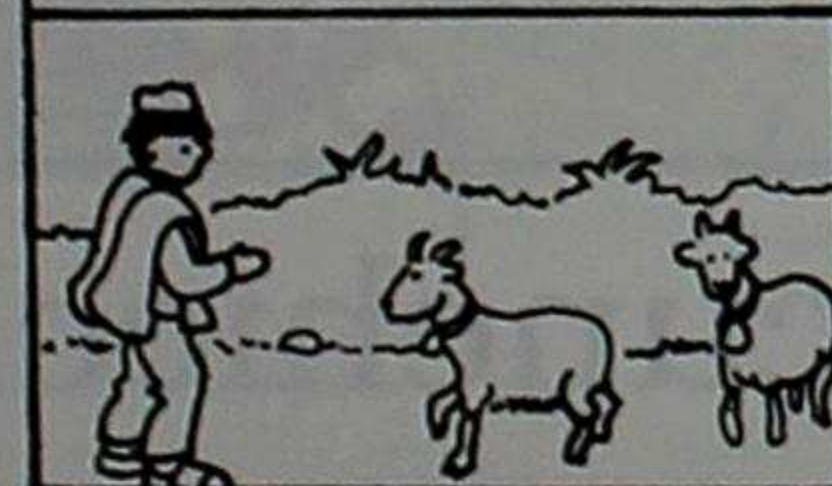

Paica  
chitamacmi can.





Ama macanacunchicchu.

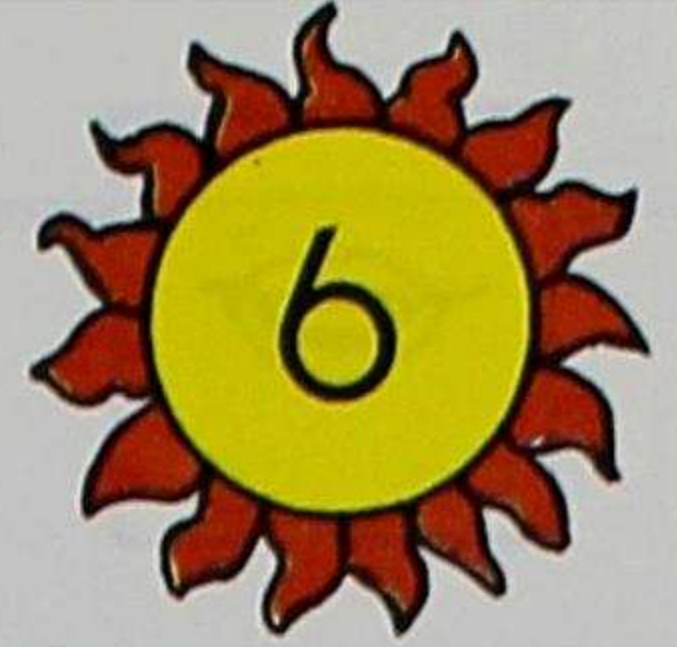
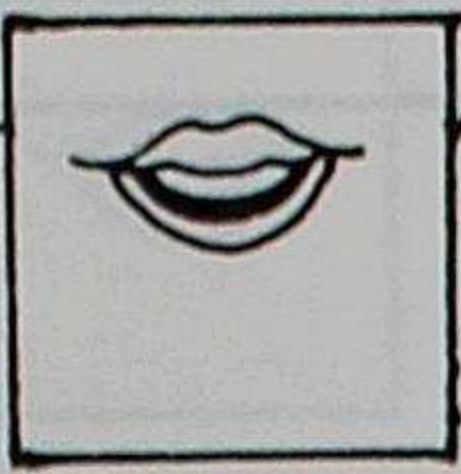

Huahuaca ñañantín quihuatami  
apacun.

huahuaca  
huahua  
hua hua  
hua

ñañantín  
ñaña  
ña ña

quihuata  
quihua  
qui hua  
qui

hua hui

ña ñu

qui

h = H

ñ = Ñ

q = Q

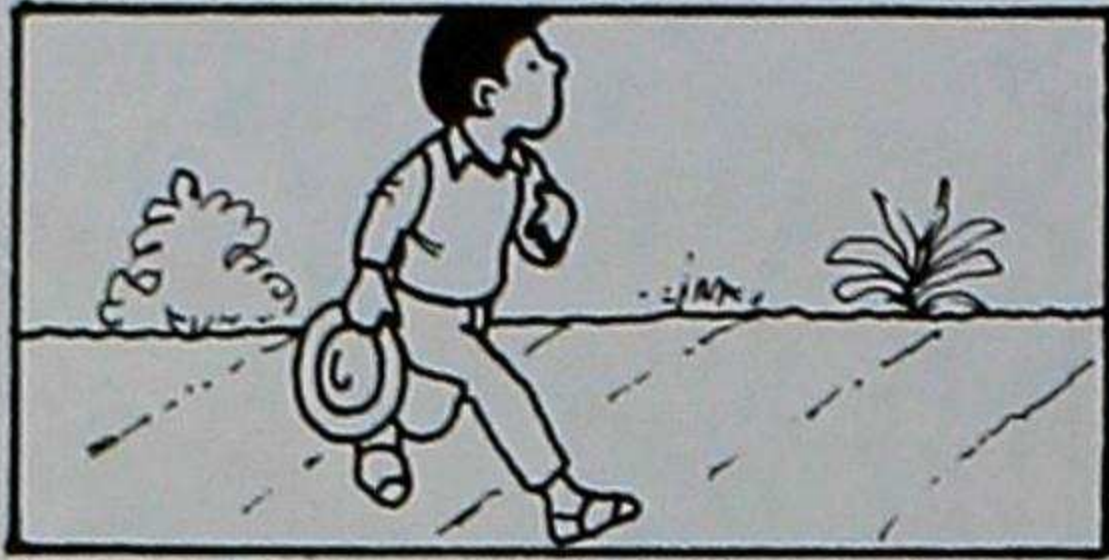
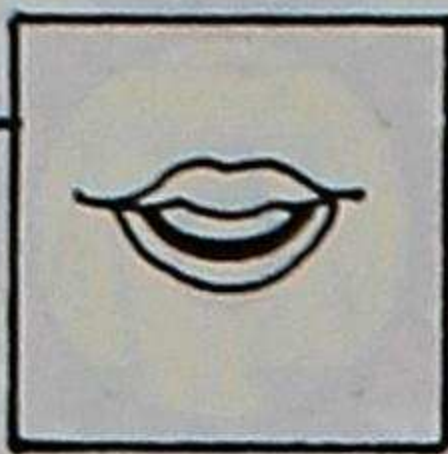

**huahua**

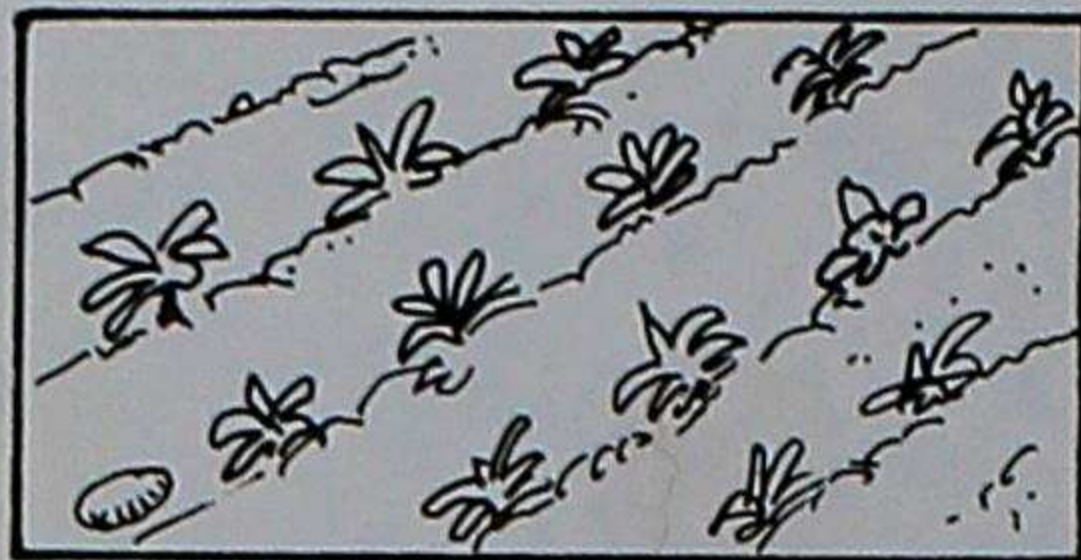

**huachu**

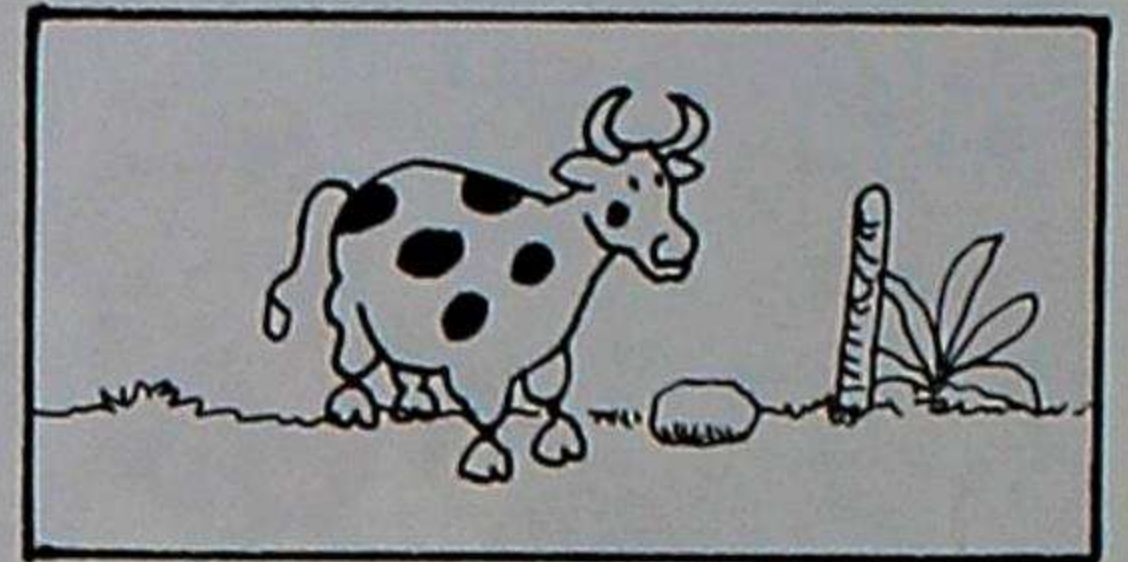

**huihua**

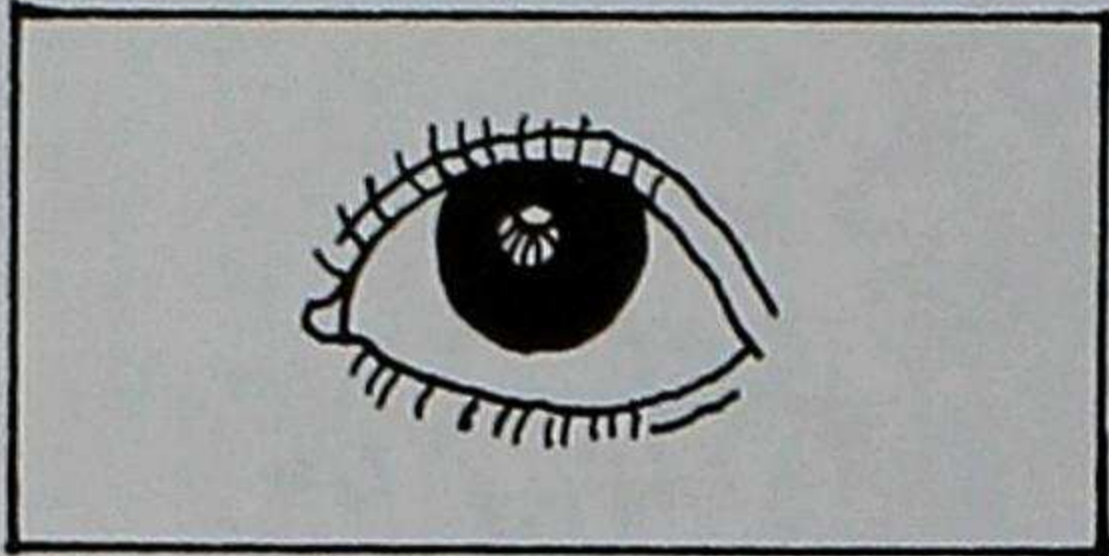

**ñahui**

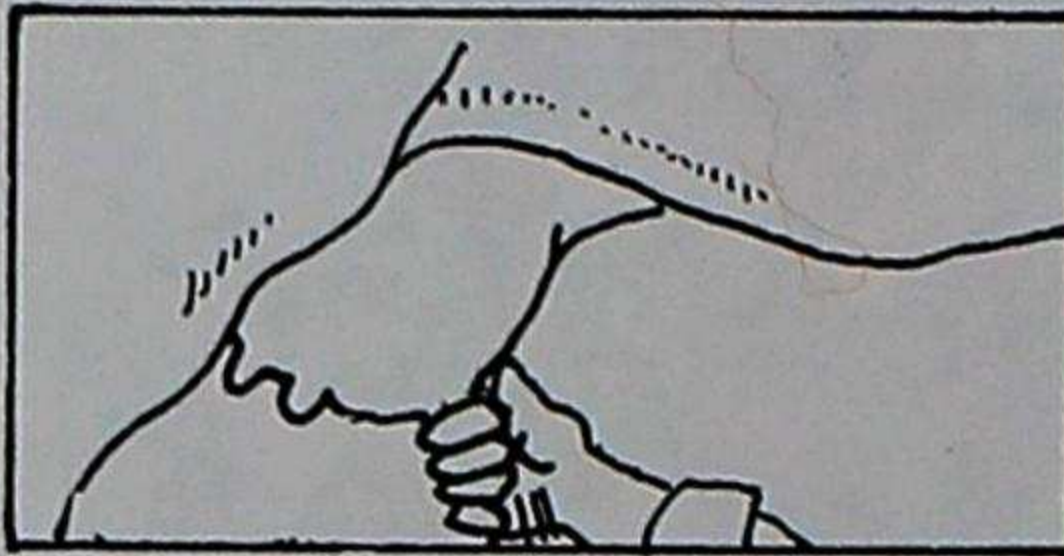

**ñuñu**

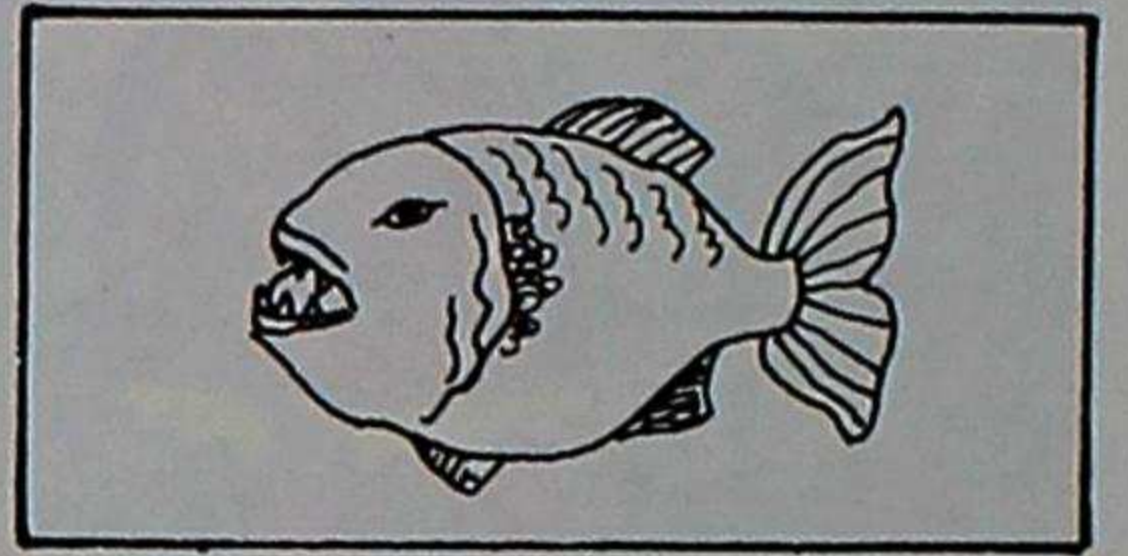

**pañã**

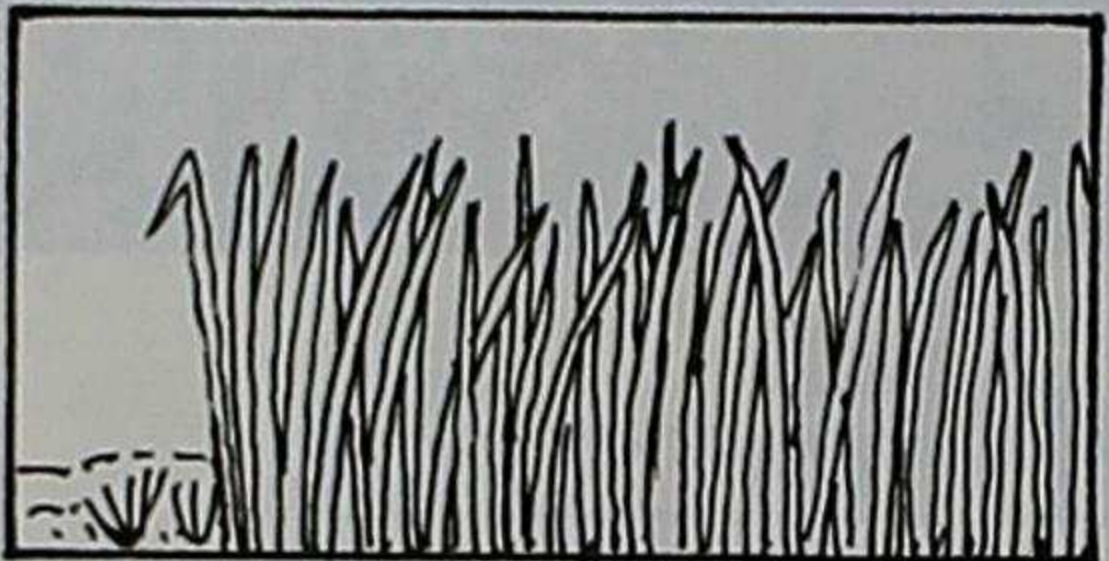

**quihua**

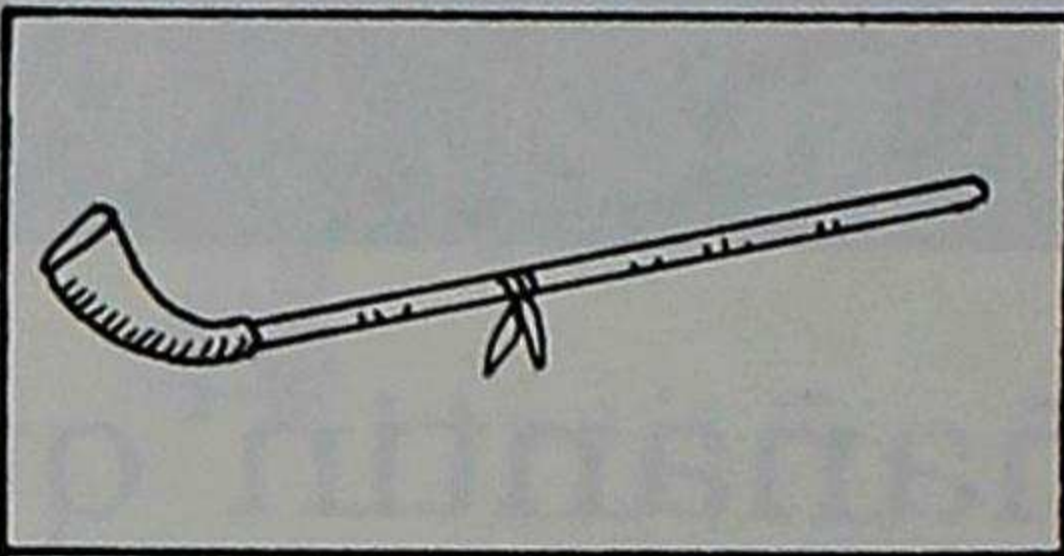

**quipa**

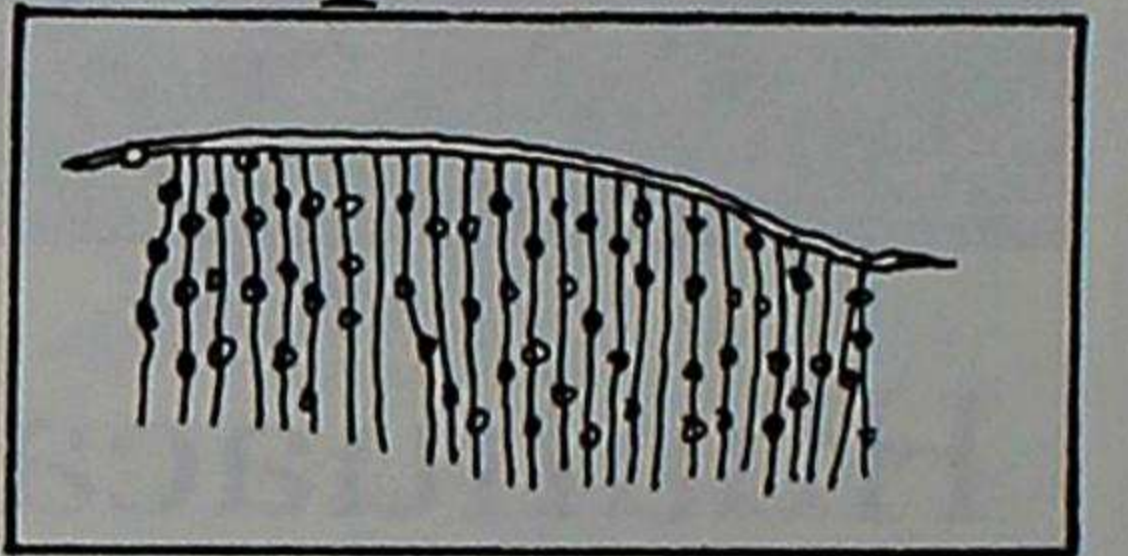

**quipu**

**huasi**  
**chahua**  
**huaccha**  
**cuhuai**

**huihua**  
**ñahui**  
**huicsa**

**ñañu**  
**ñaña**  
**añas**  
**ñausa**

**ñutu**  
**puñu**  
**ñutcu**  
**puñui**

**quichua**

**chaqui**

**quichqui**

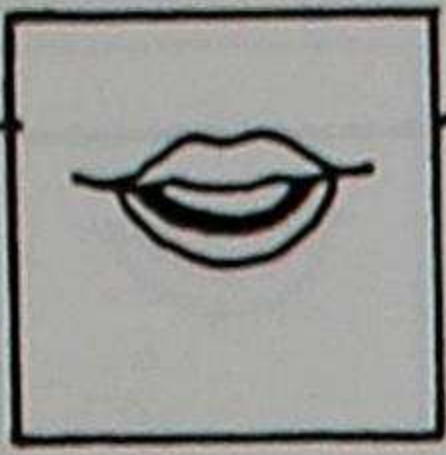

quihua

quihuah**uan**

ñaña

huihua

ñañah**uan**

huihuah**uan**

cuna

ña

cuna

cuh**uai**

- \* Taitaca cuchapi cahuinahuanmi cahuicun.
- \* Huahuaca ñañahuan tanpupimi samacun.
- \* Cai ichuhuan quinuata cuchunimi.
- \* Huahuaca tantata cuhuai ninmi.
- \* Taitaca apiuta ña apacunmi.

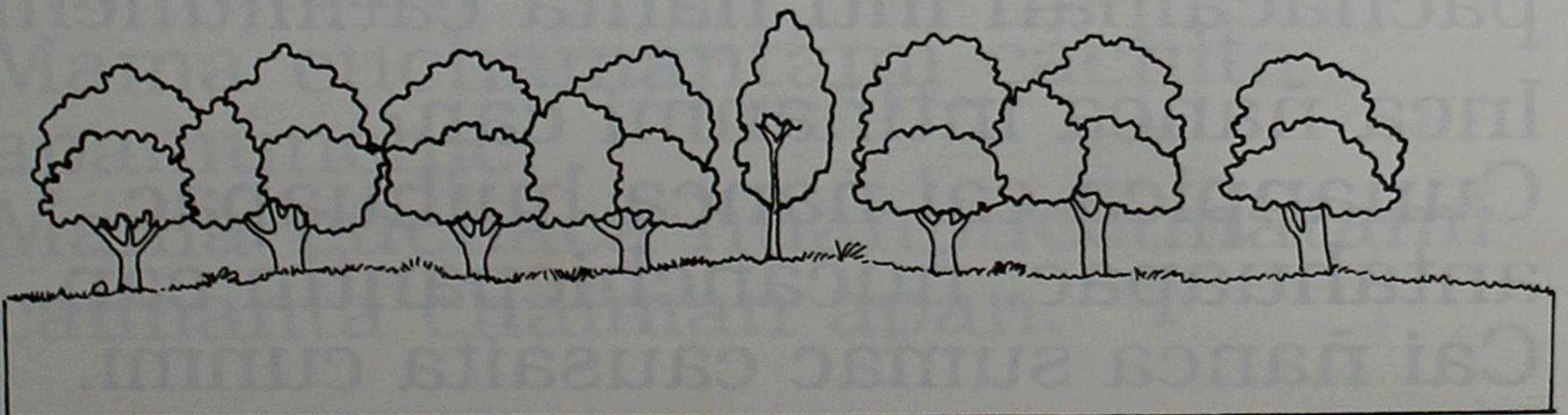

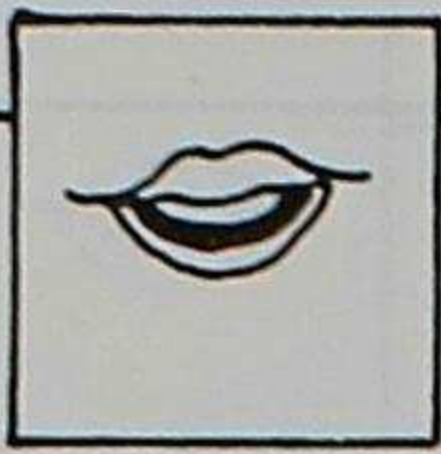

**Taitaca huanpunapimi can.**

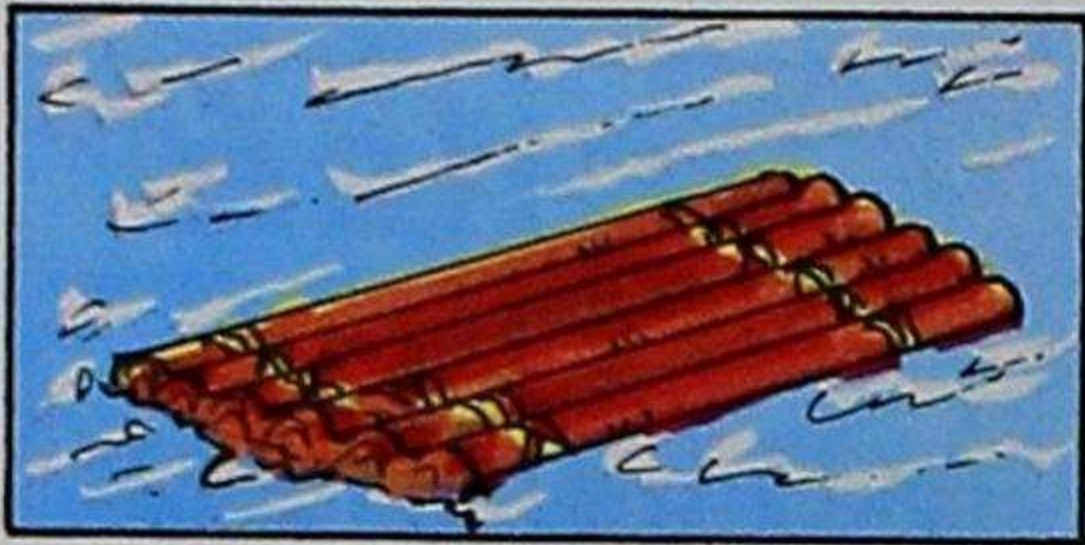

huanpuna

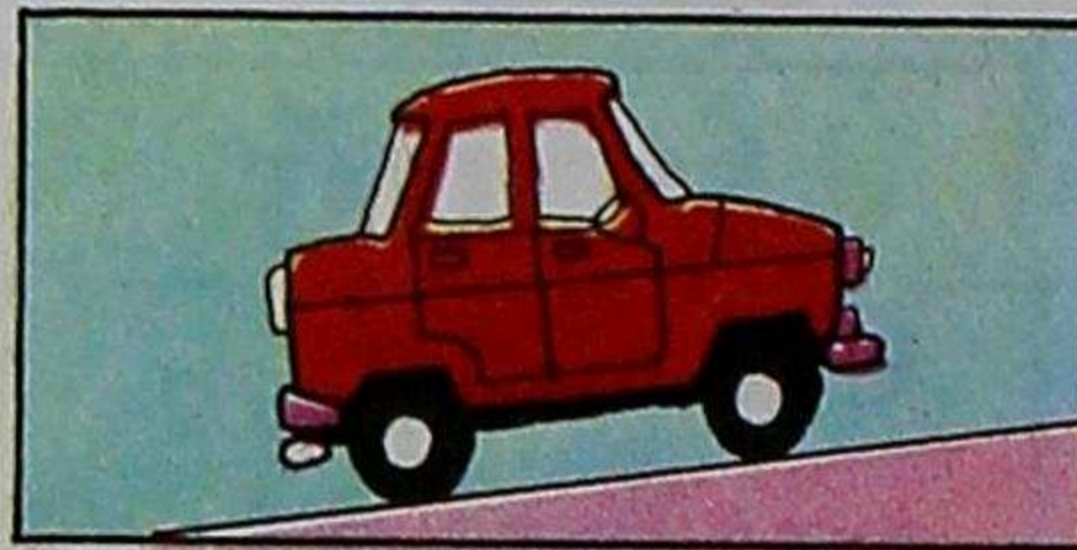

antahua

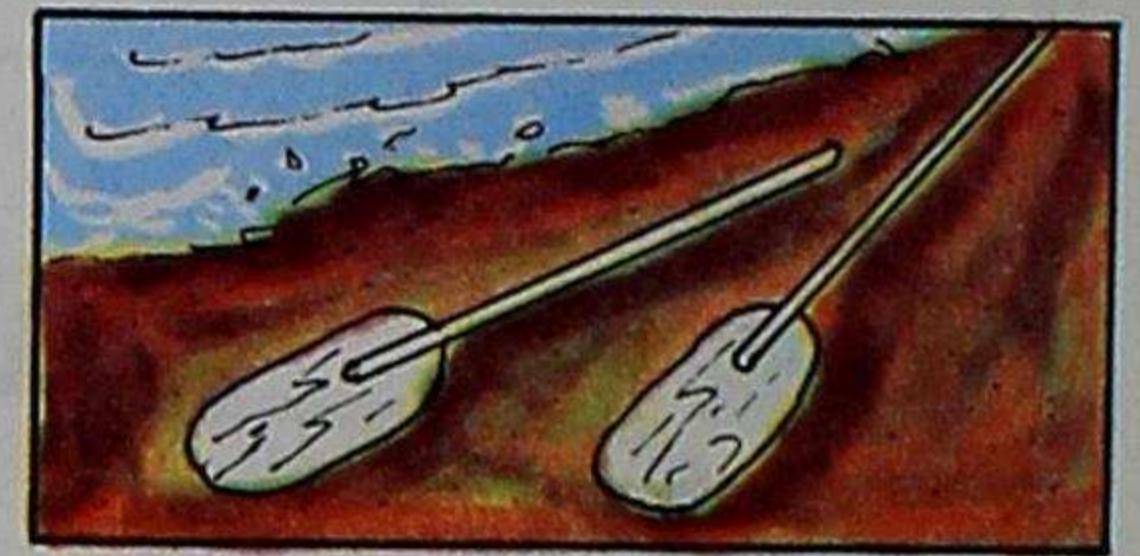

cahuina

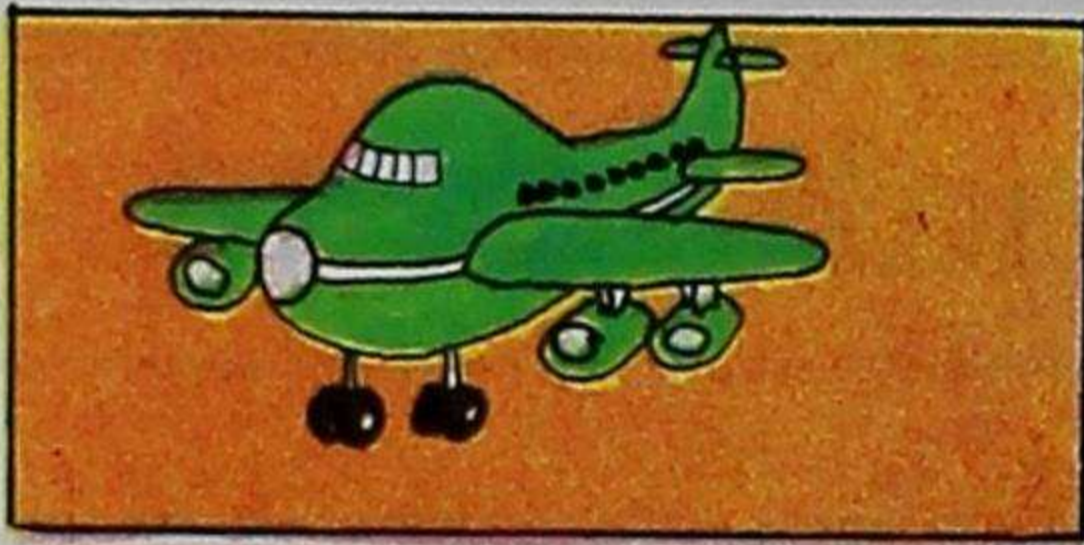

antanca



apiu



ñan

## **Intiñanmanta**

Inca pachamanta cunan  
pachacaman inti ñanta catimunchic.

Inca ñanca intiñanmi can.

Cunanpica cai ñanca huihuapac,  
antahuapac, ñucanchicpantin can.

Cai ñanca sumac causaita cunmi.

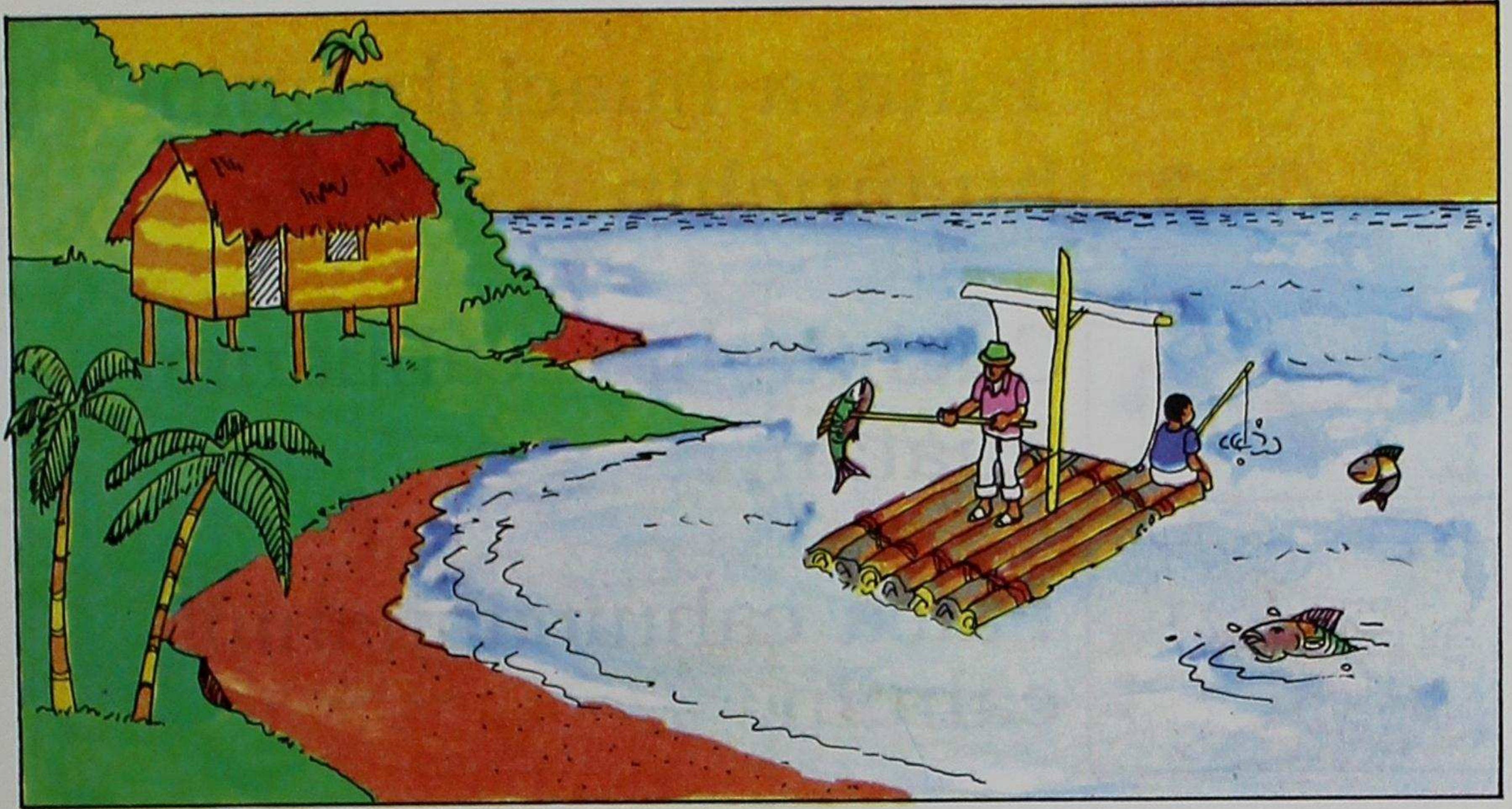

## Mama cuchamanta

Mama cuchami sumac micuicunata  
ñucanchicman cun.

Cunancamanmi taitacunaca  
huachihuan mamacuchapi causac  
huihuacunata micuncapac  
huañuchin.

Mama cuchamantami cachita  
apamunchic.

Mama cuchaca huanpuccunatami  
caimanta chaiman apan.

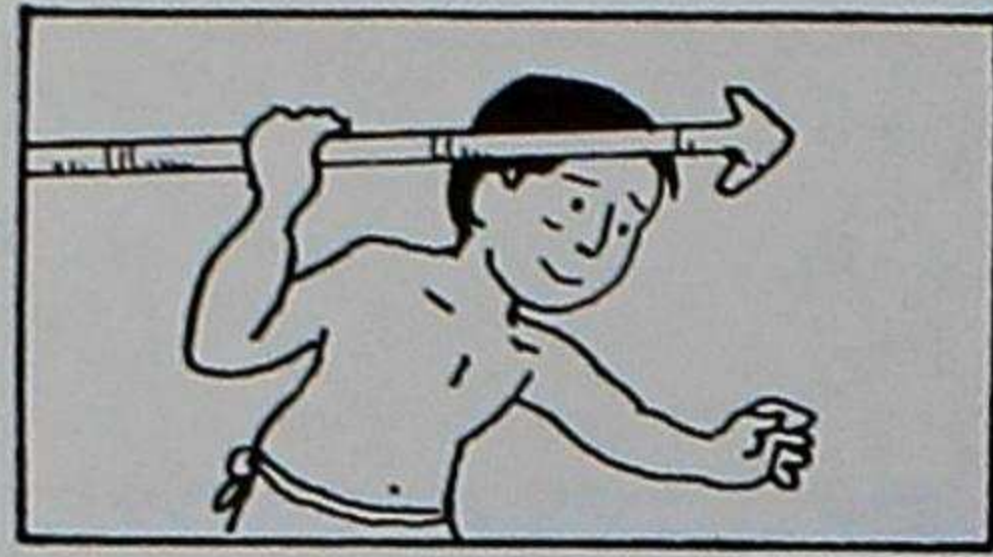
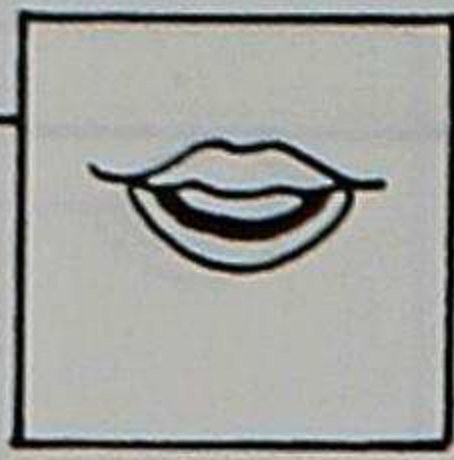

Taitaca huachihuanmi  
huañuchin.

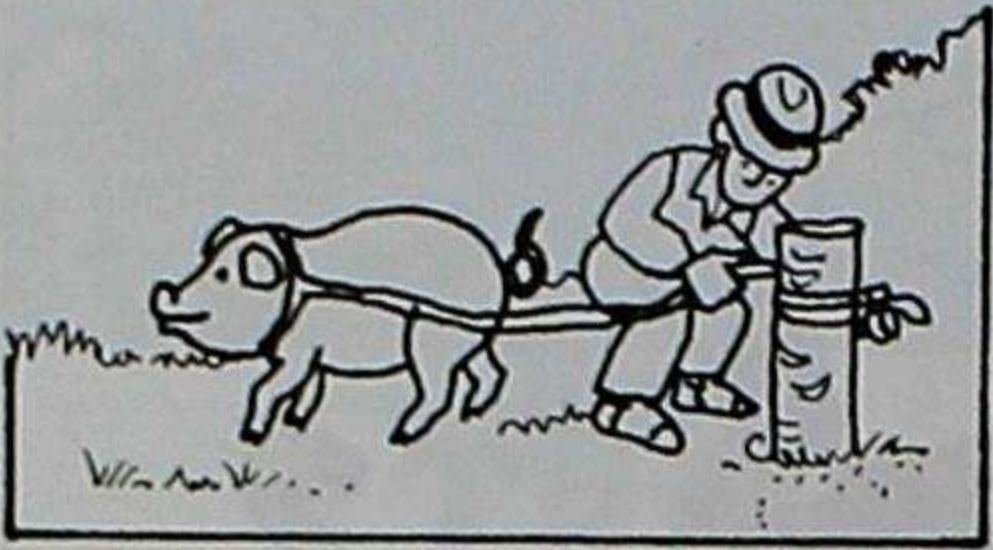

Cuchita huascahuanmi  
huatan.



Paica cahuinahuanmi  
cahuin.

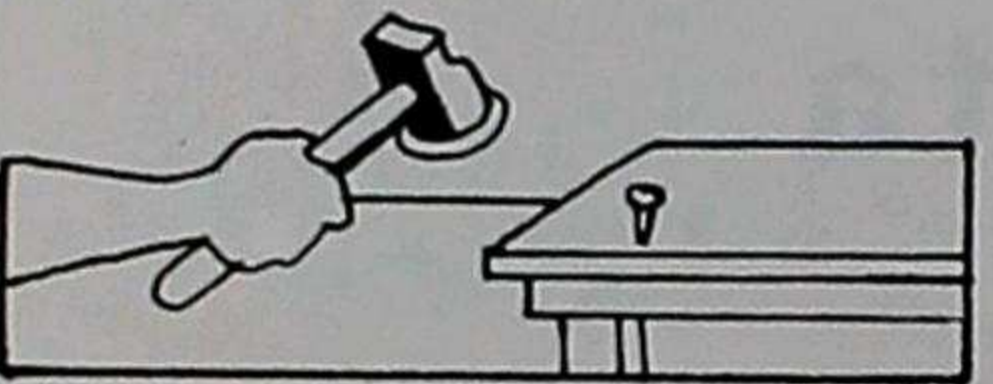

Tacanahuanmi tacan.

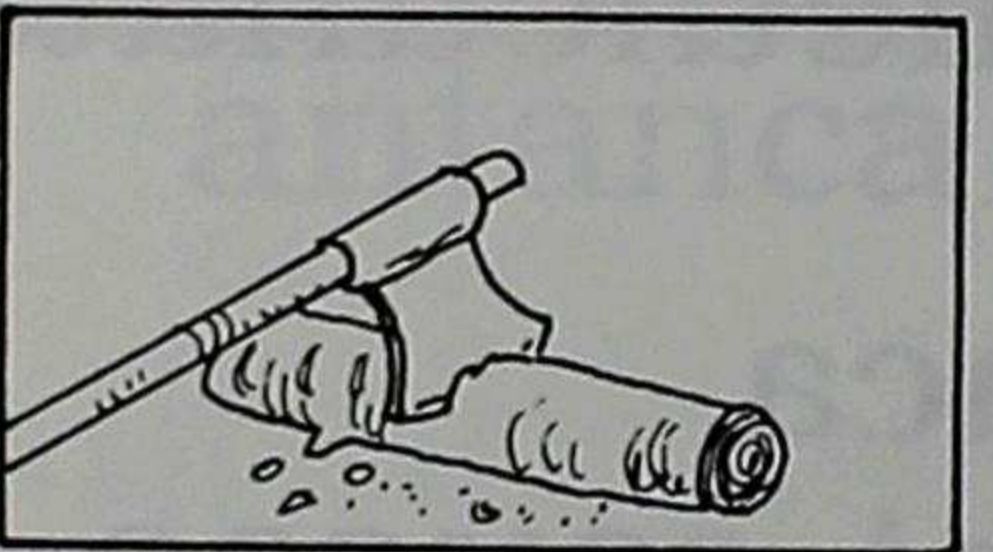

Tumihuan caspitami  
chictan.

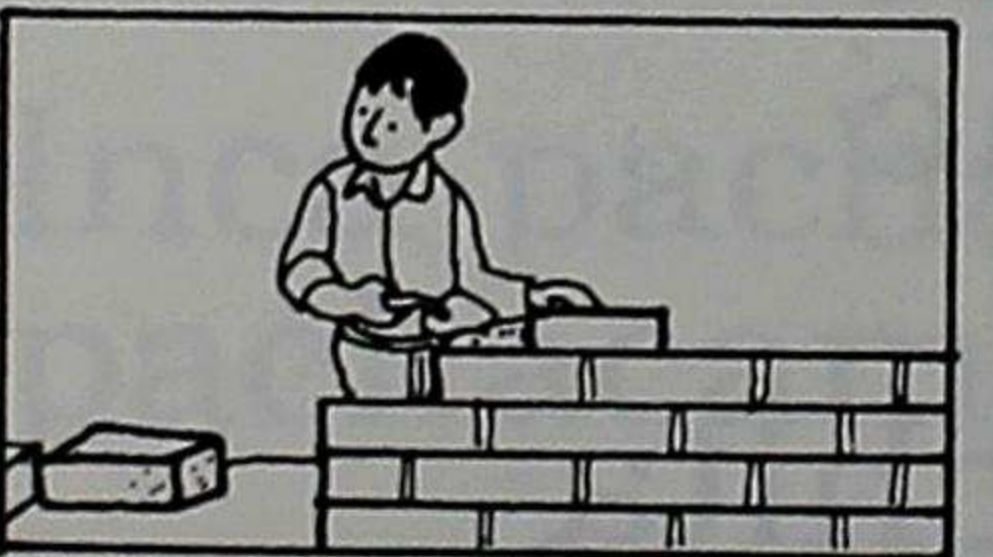

Ticahuan huasichinmi.

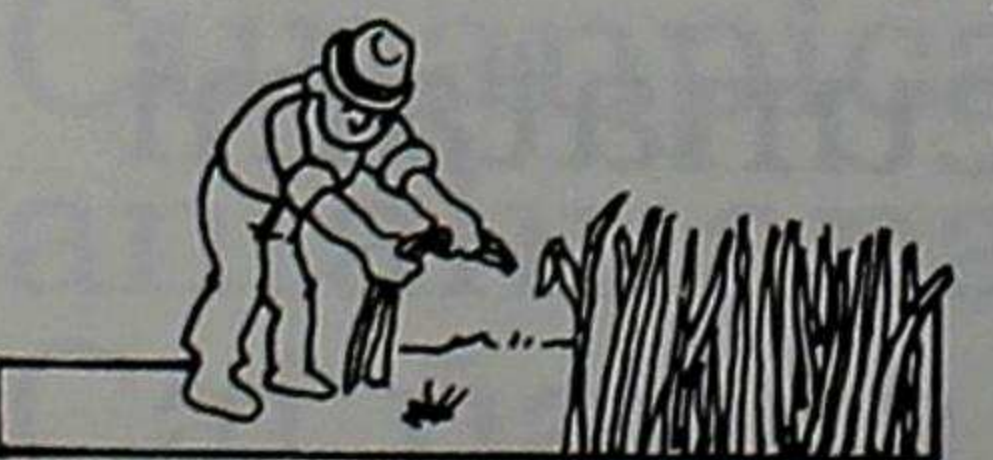

Maquihuan quihuatami  
pitini.

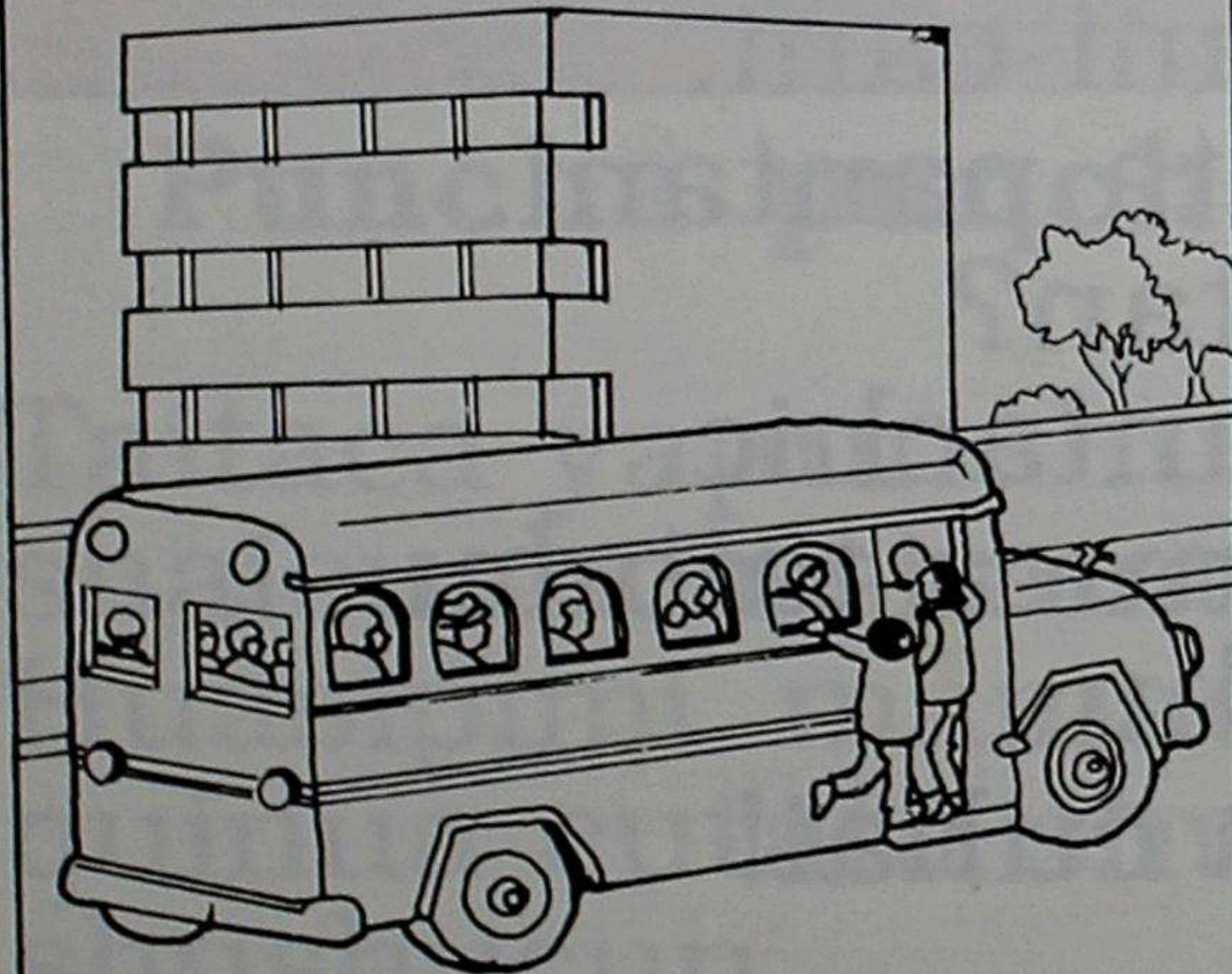
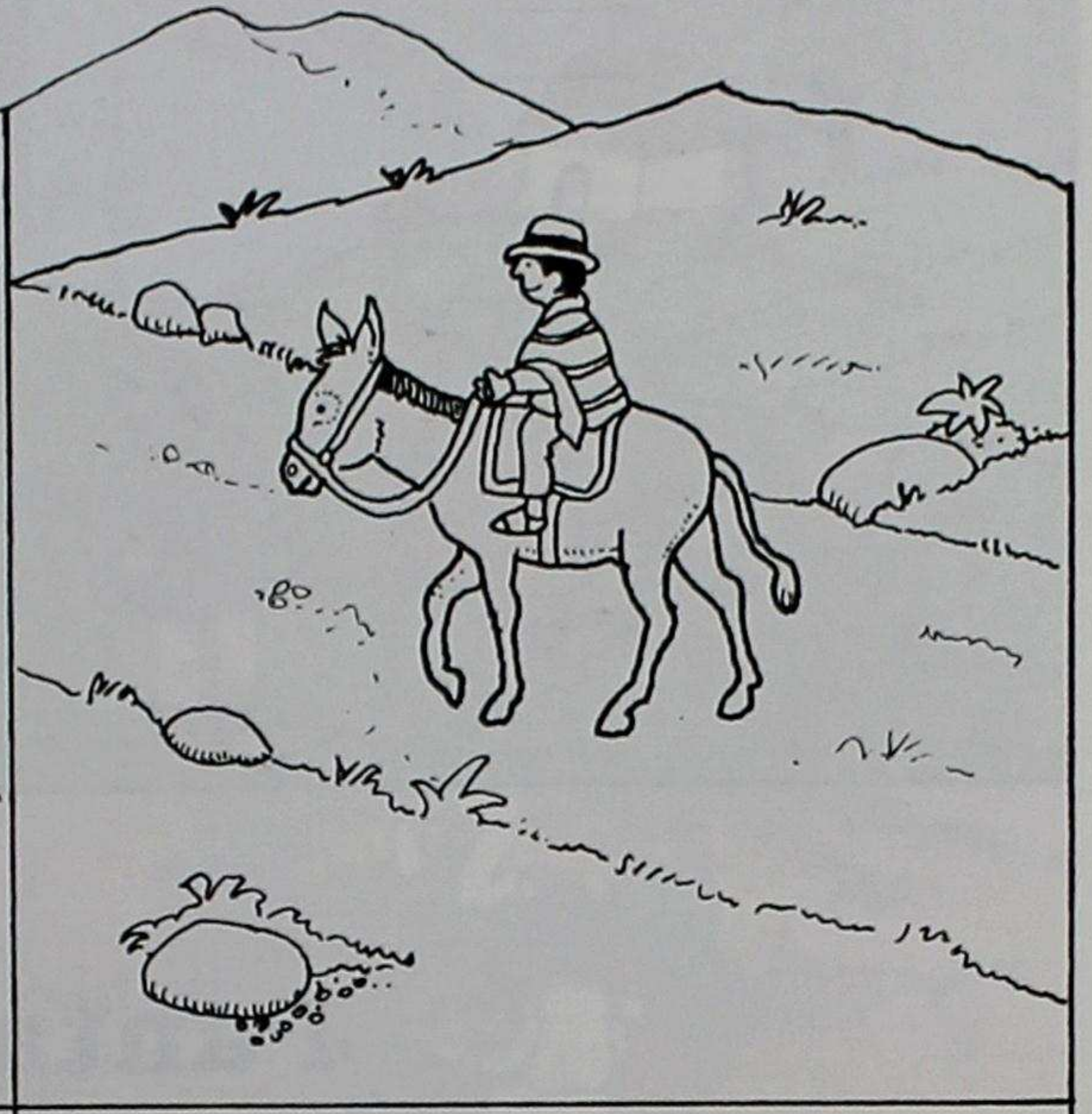
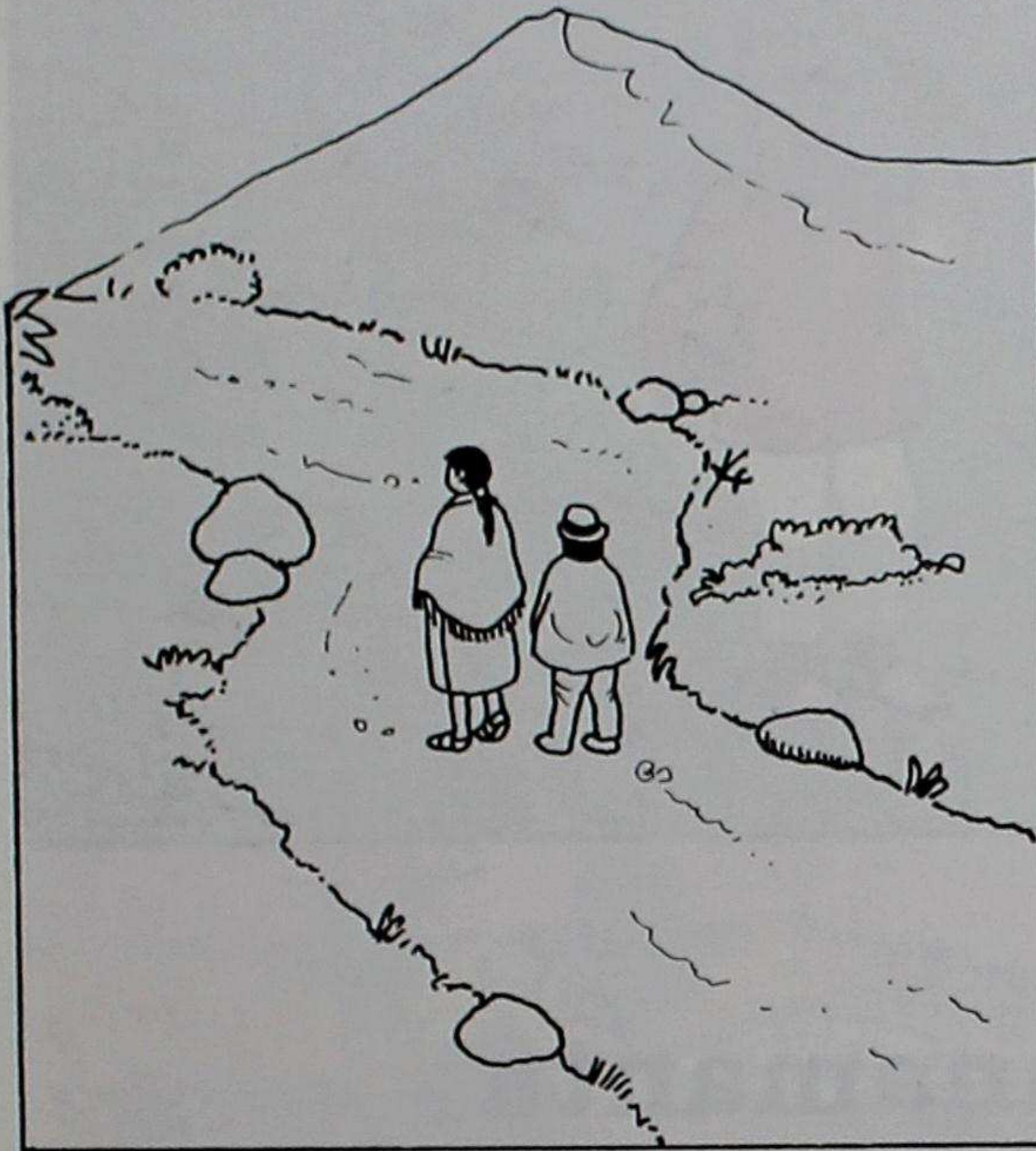
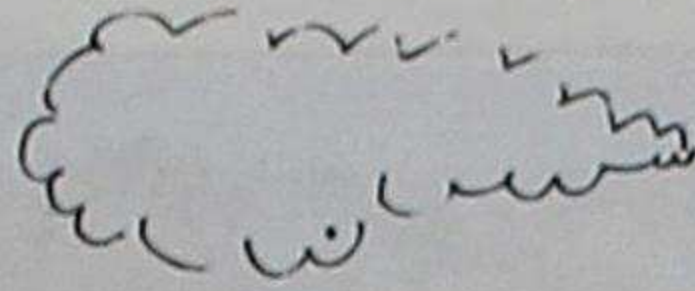
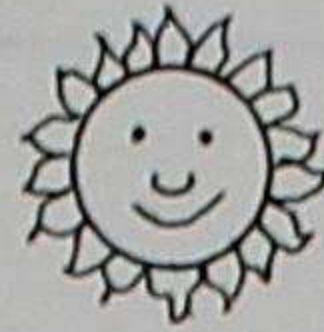
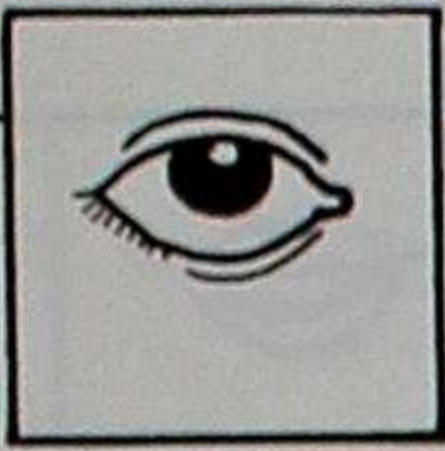



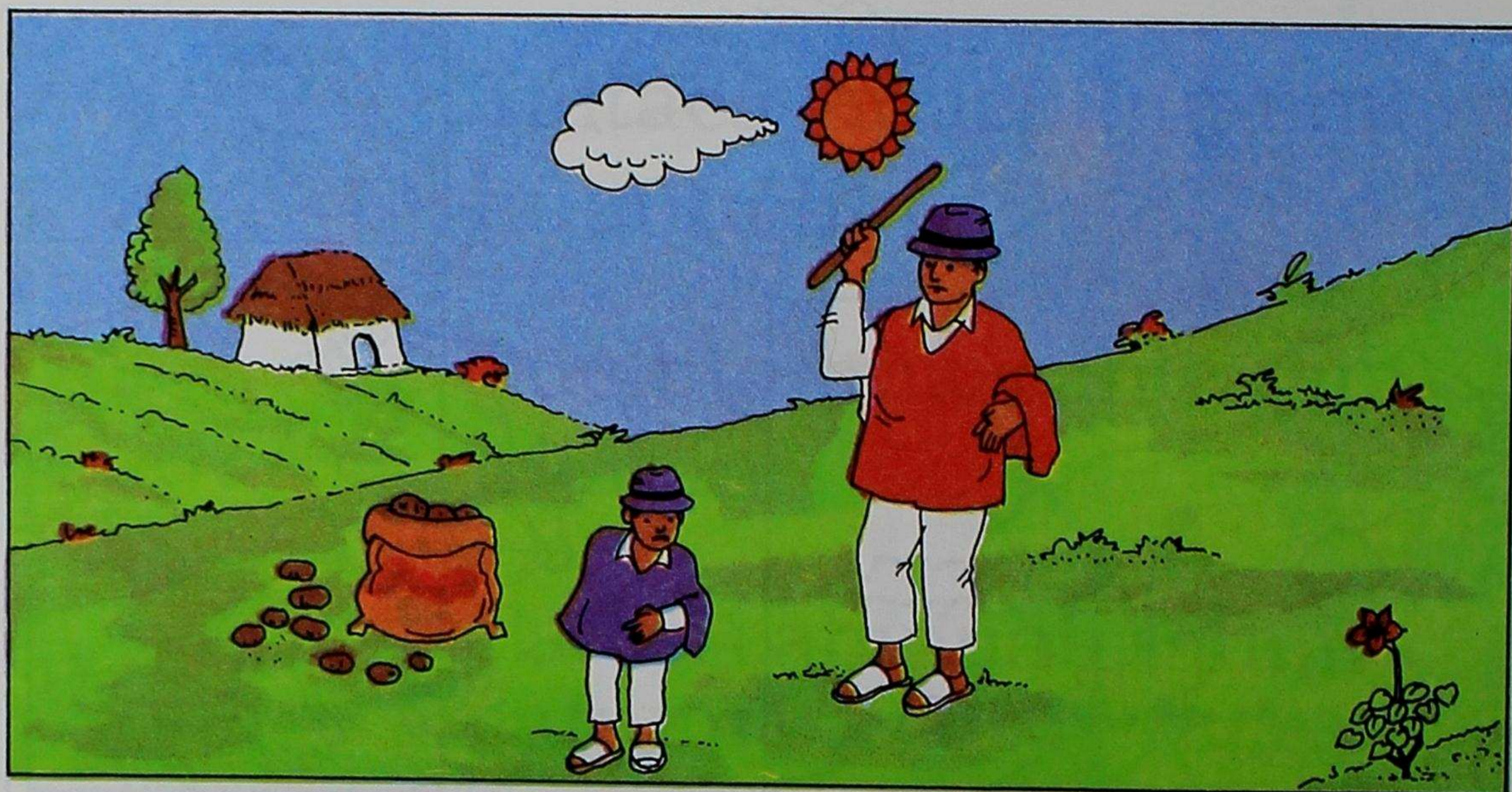
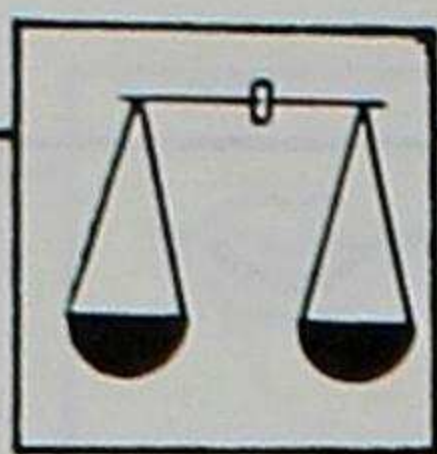

## **Pantanamanta**

Ñucaca huahuami cani.  
Huahua caimanta pantani.  
Pitac mana pantan?  
Tucuicunami pantachic.  
Ñuca mamacu, ñuca taitacu  
ama macahuaichu.  
¡Sumac causaita cuhai!

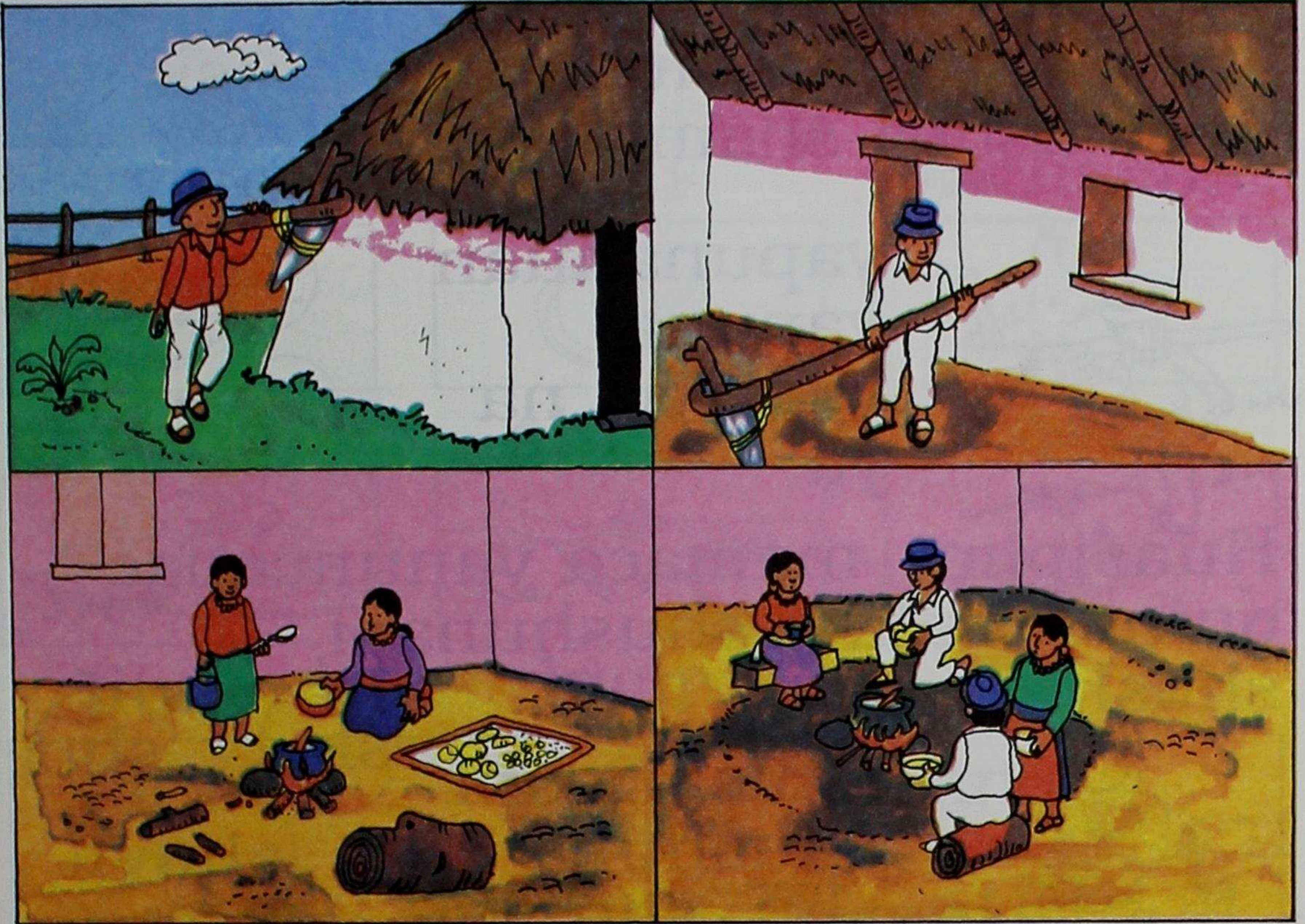
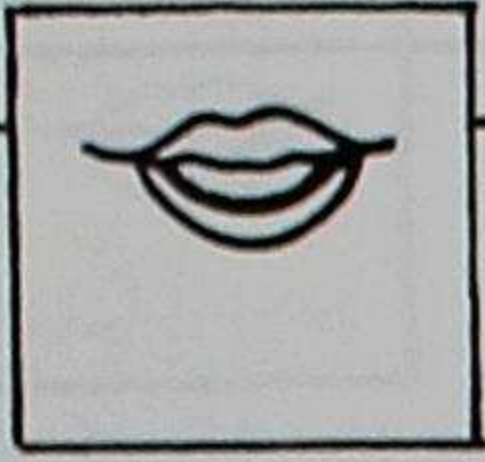

## Puncha puncha causaimanta

Taitaca yapunahuan huachushpa  
shaicushca shamucunmi.

Huasipimi mamaca yanuncapac  
quinua cutata shushunapi  
shushucun.

Chai punchaca quinua apita,  
aichata, jicamatapashmi  
micuncacuna.

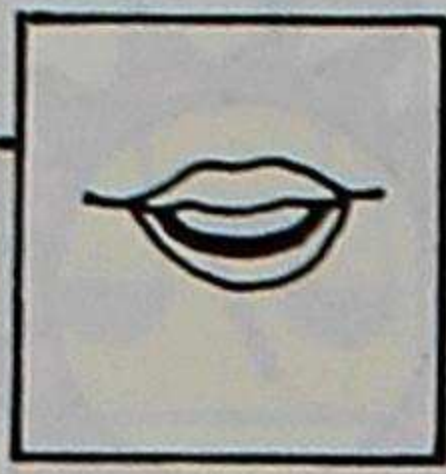

Taitaca yapunahuan huachushpa  
shaicushca shamucunmi.

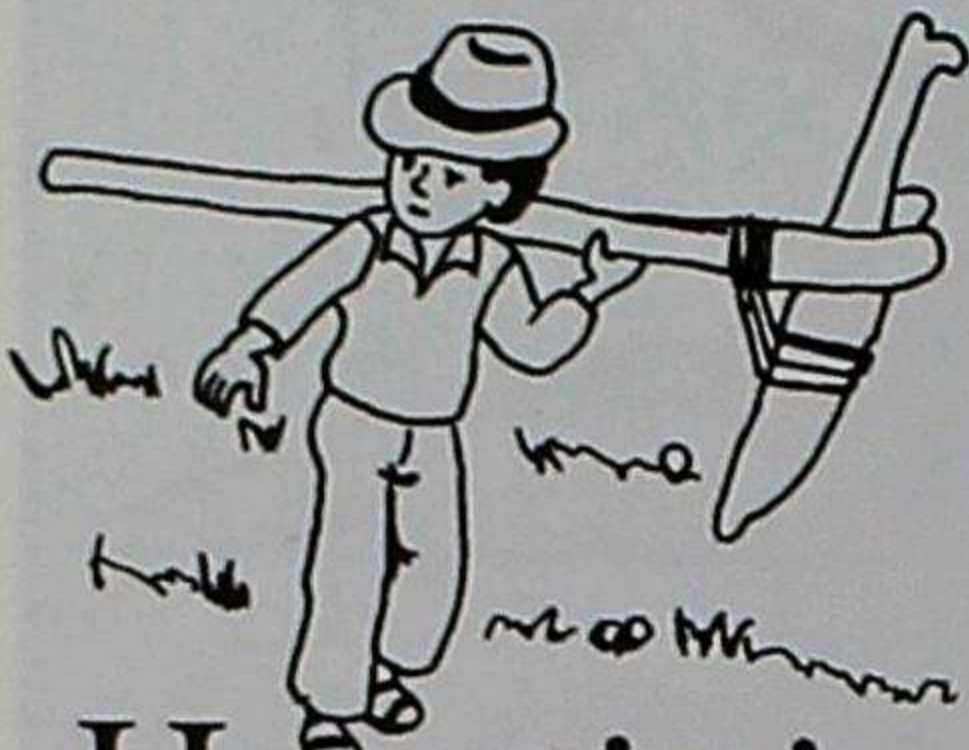

yapunahuan  
yapuna  
ya pu na  
ya

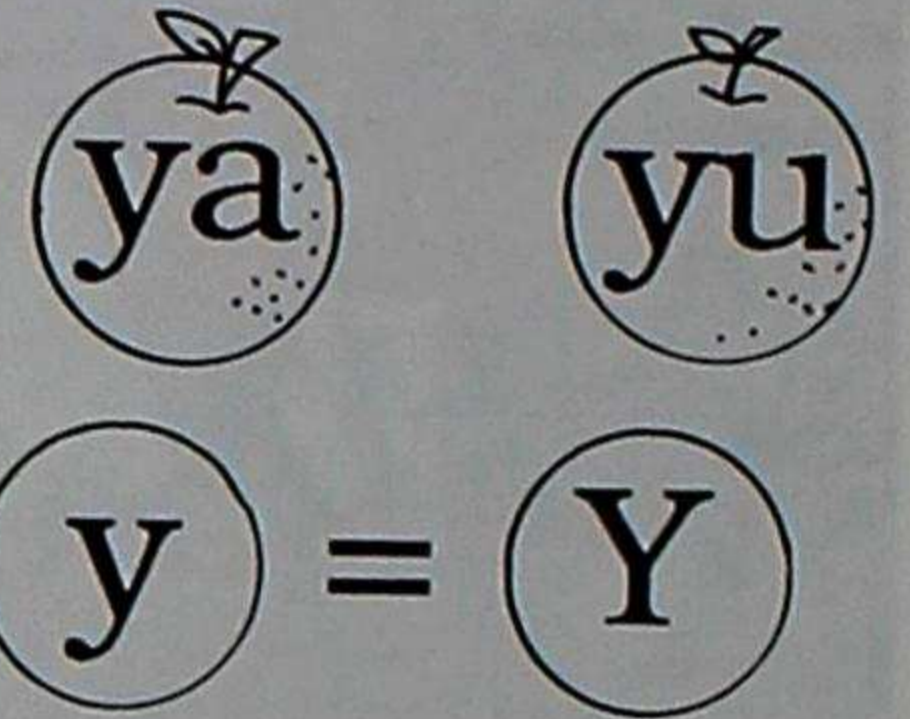

Huasi pimi mamaca yanuncapac  
quinua cutata shushunapi  
shushucun.



shushunapi  
shushuna  
shu shu na  
shu

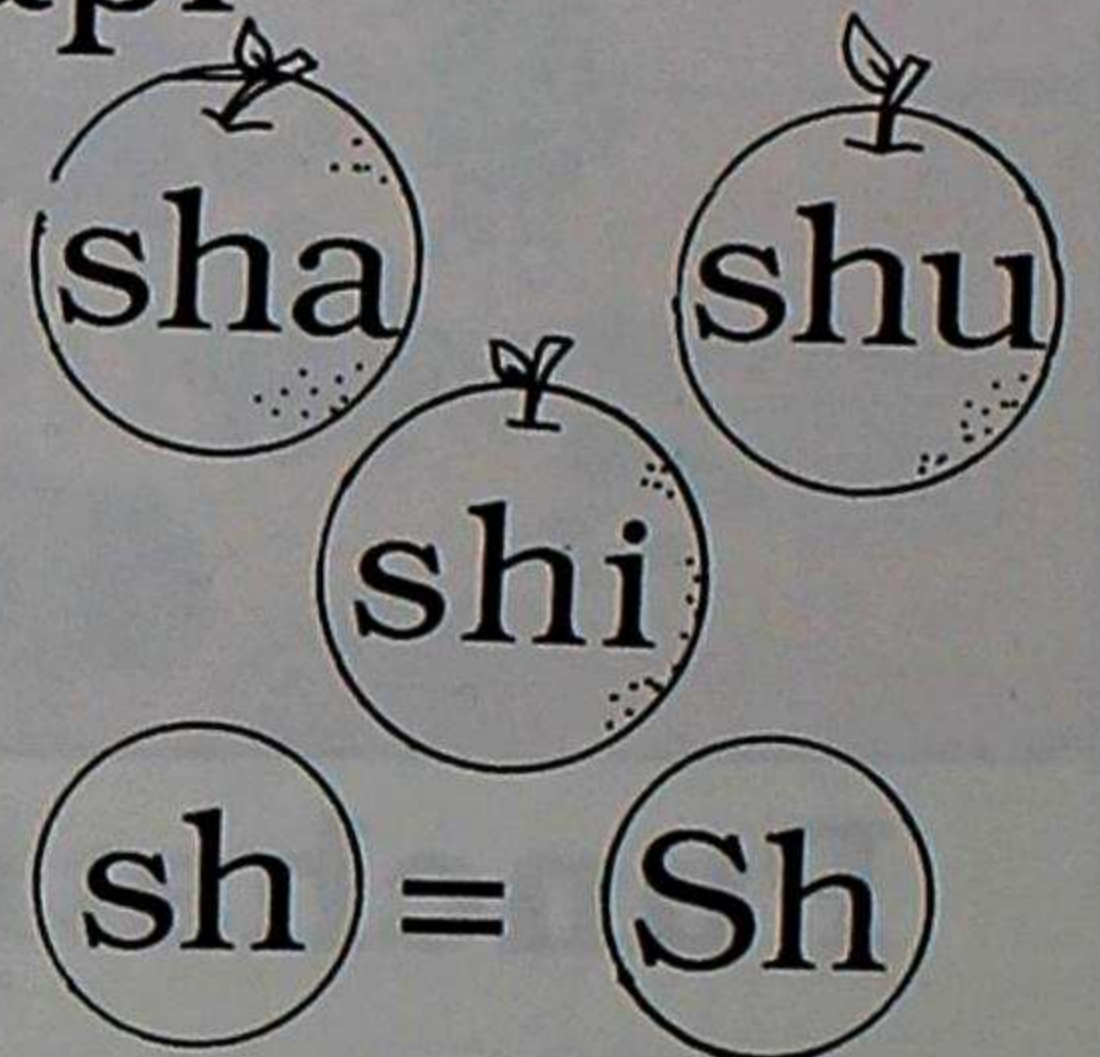

Chai punchaca quinua apita,  
aichata, jicamatapashmi  
micuncacuna.



jicamatapashmi  
jicama  
ji ca ma  
ji

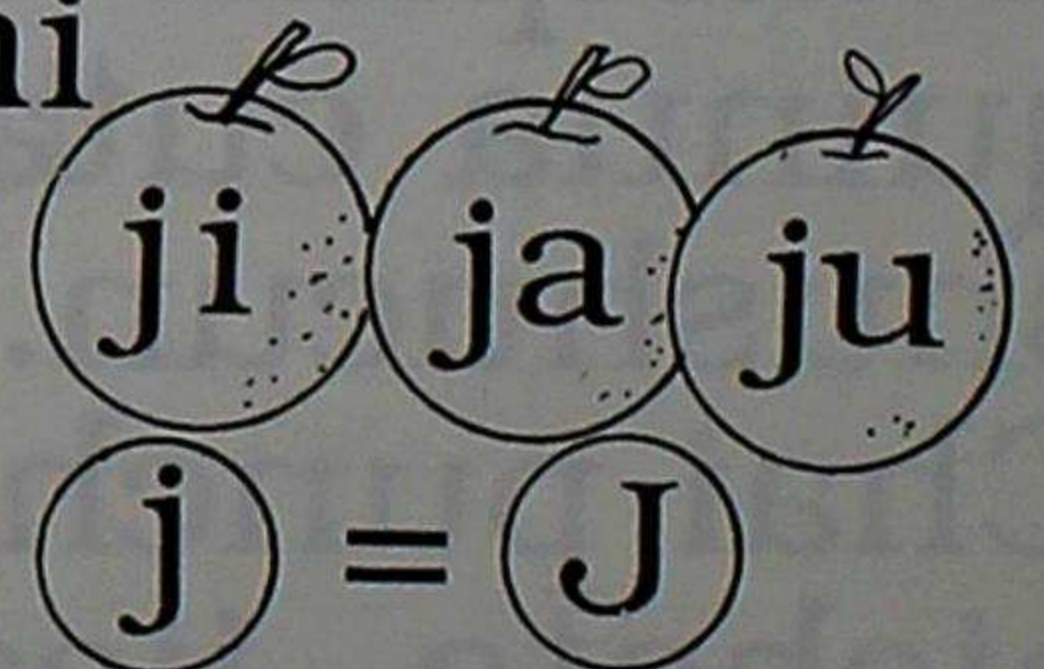

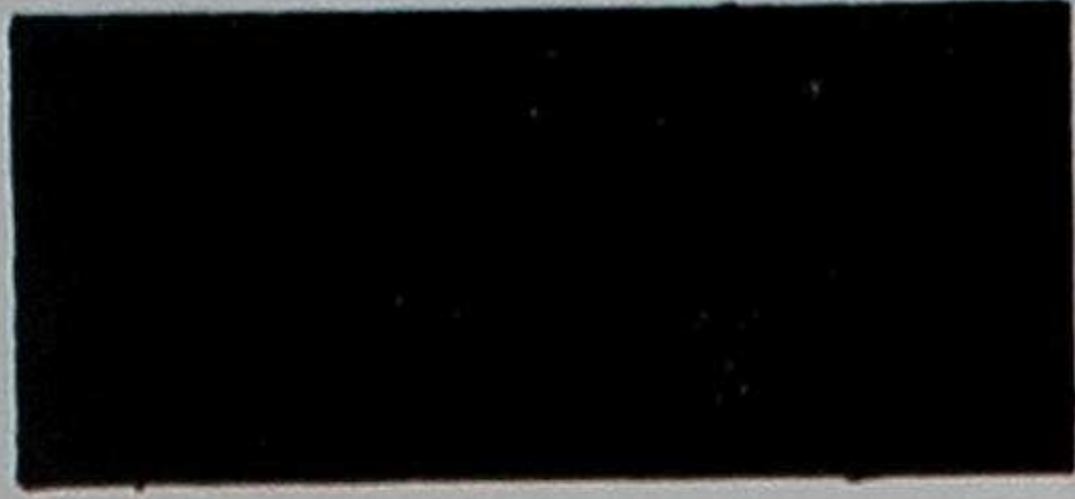

**yana**

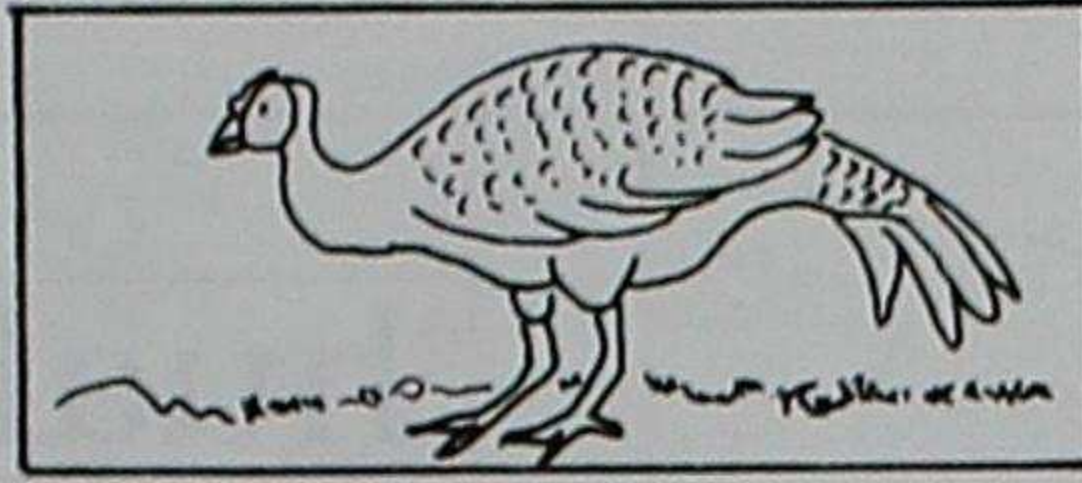

**yutu**



**yachachic**

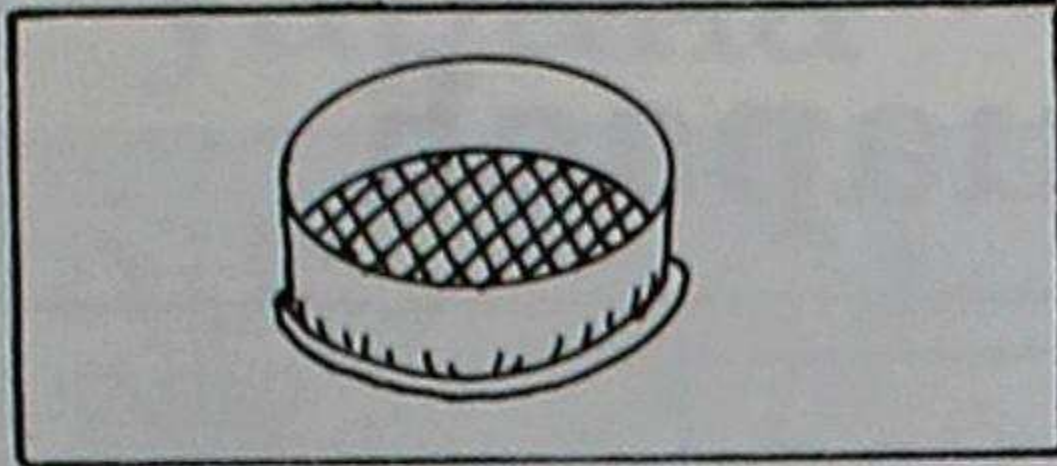

**shushuna**

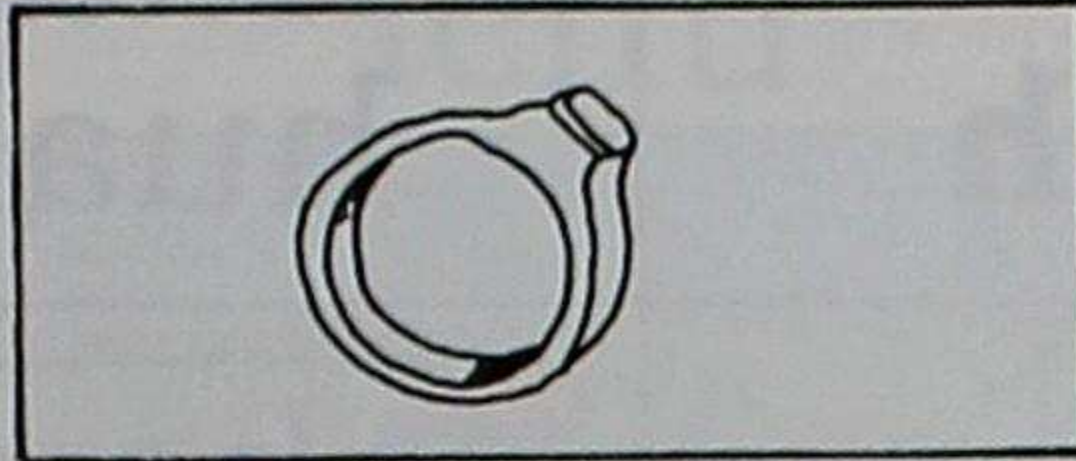

**shihui**

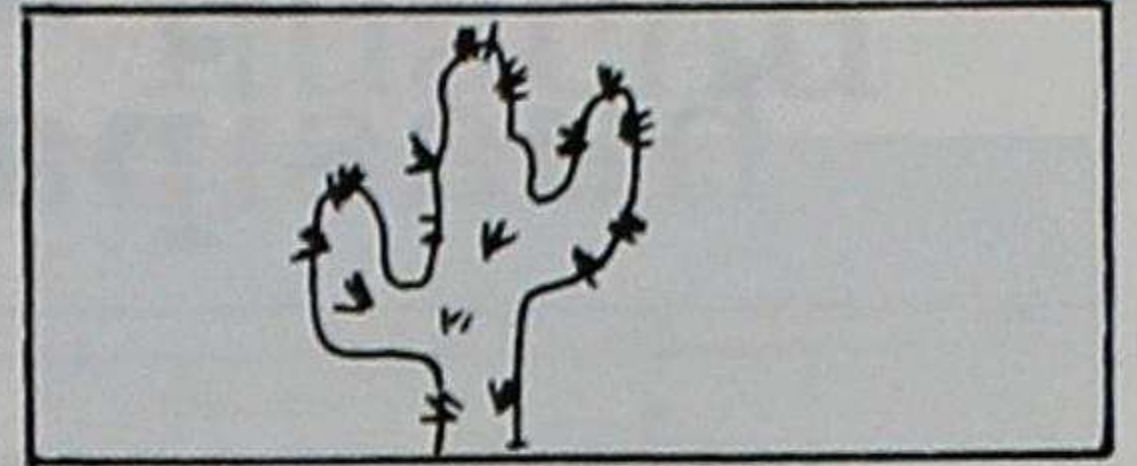

**casha**



**jita**

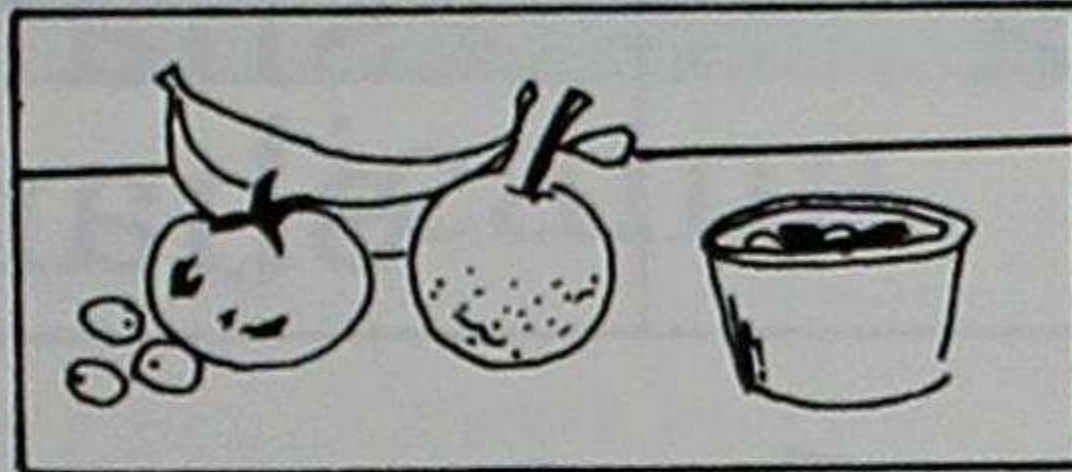

**juchu**

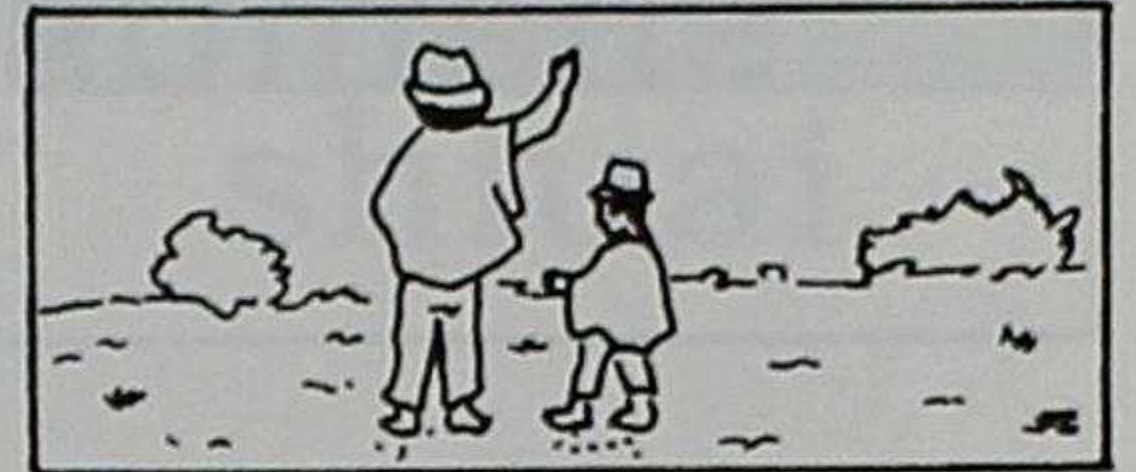

**jatun**

<p><b>yacu</b> <b>aya</b> <b>yaicui</b></p>	<p><b>yupana</b> <b>yuyu</b> <b>cuyui</b></p>	
<p><b>shayana</b> <b>quisha</b> <b>shanshi</b> <b>shaicuna</b></p>	<p><b>shuyana</b> <b>tushuna</b> <b>shuncu</b> <b>mashua</b></p>	<p><b>shimi</b> <b>mashi</b> <b>shicshi</b></p>
<p><b>jacuna</b> <b>janpatu</b> <b>jau</b></p>	<p><b>juchu</b> <b>junpi</b></p>	<p><b>jiqui</b> <b>jicyana</b></p>

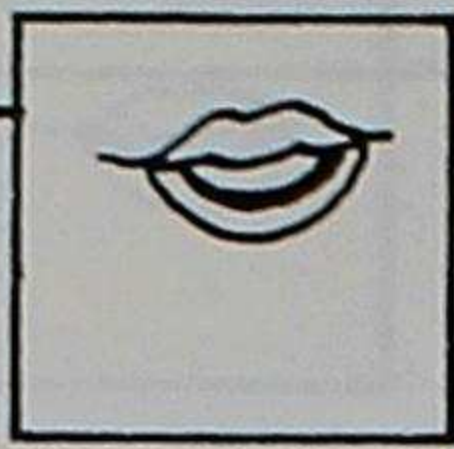

<p><b>huasi</b></p> <p>huasi<b>yuc</b> huasi<b>pash</b></p>	<p><b>huahua</b></p> <p>huahu<b>ashi</b> huahu<b>apash</b></p>
<p><b>shamuna</b></p> <p>shamu<b>sha</b></p>	<p><b>shamuna</b></p> <p>shamun<b>ashi</b> shamun<b>apash</b></p>

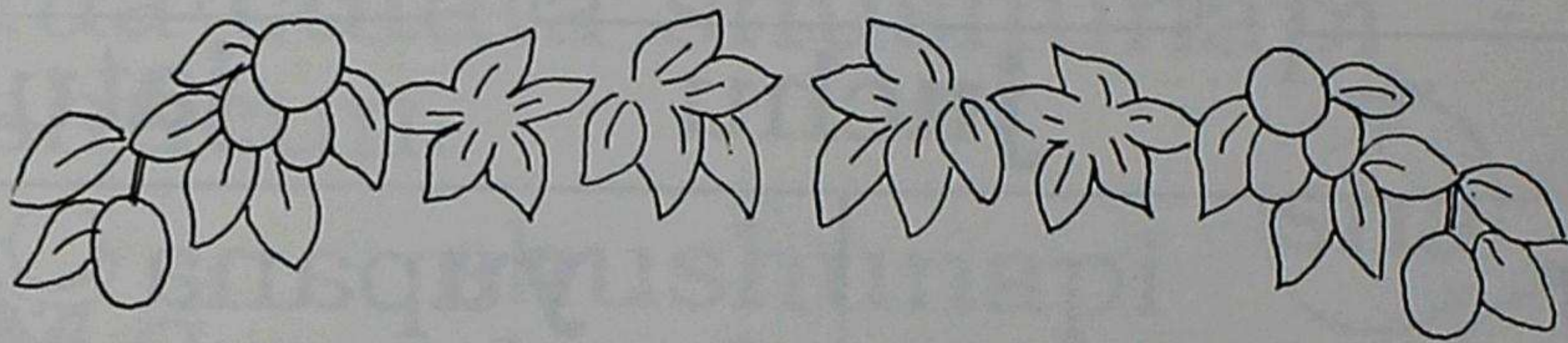

- \* Mashuaca uca shinami can.
- \* Chai yayaca huasiyucmi.
- \* Pipac cuchishi caica?
- \* Canpac taitaca shamunashi?
- \* Caya janpincapac shamusha.
- \* Caya puncha yapusha.
- \* Cai panpapica quinuata jichasha.
- \* Paica shamunapashmi.
- \* Mama, taita, ushushipashmi  
panpamanta shamunca.

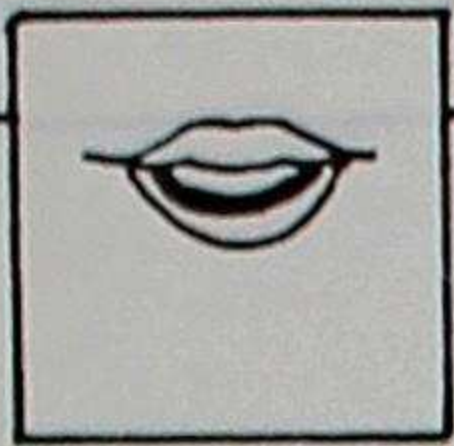

yapuna

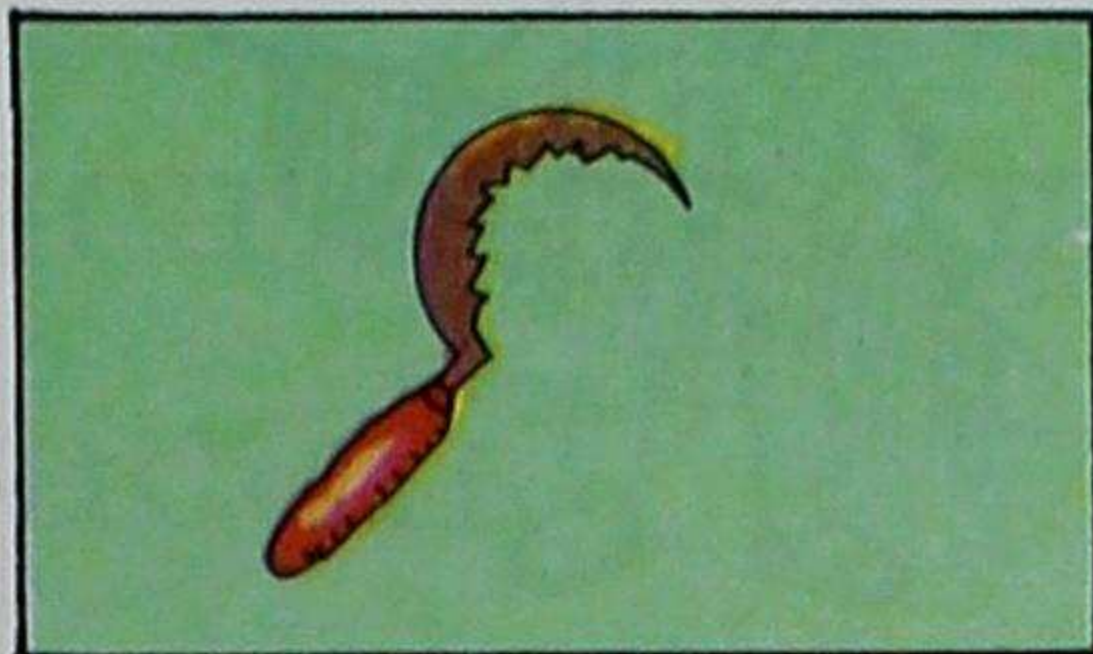

ichu

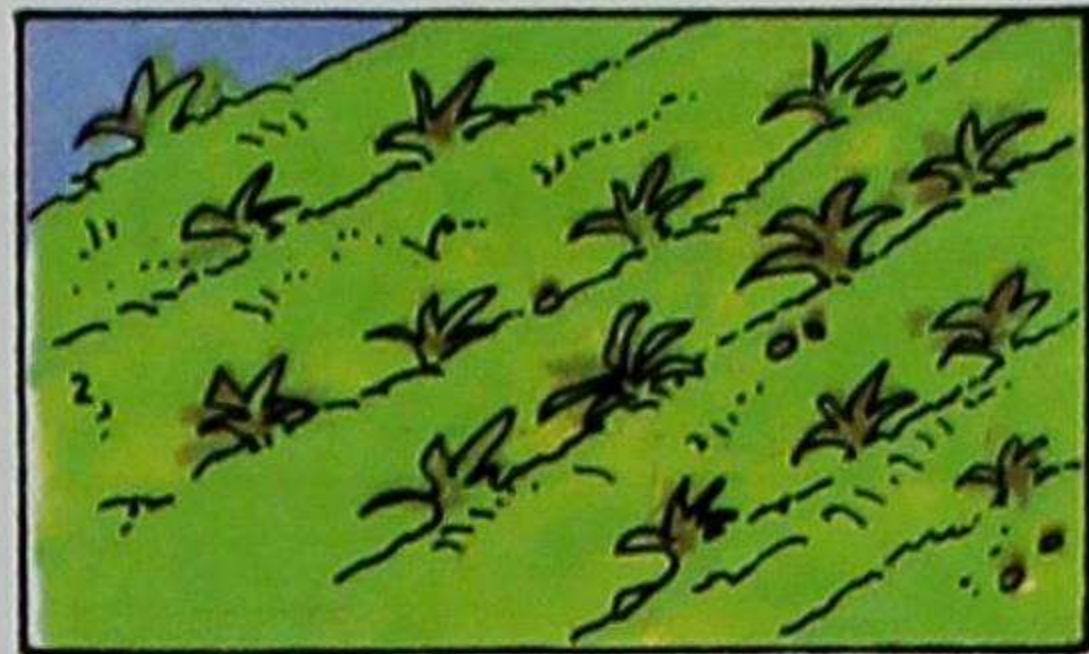

huachu

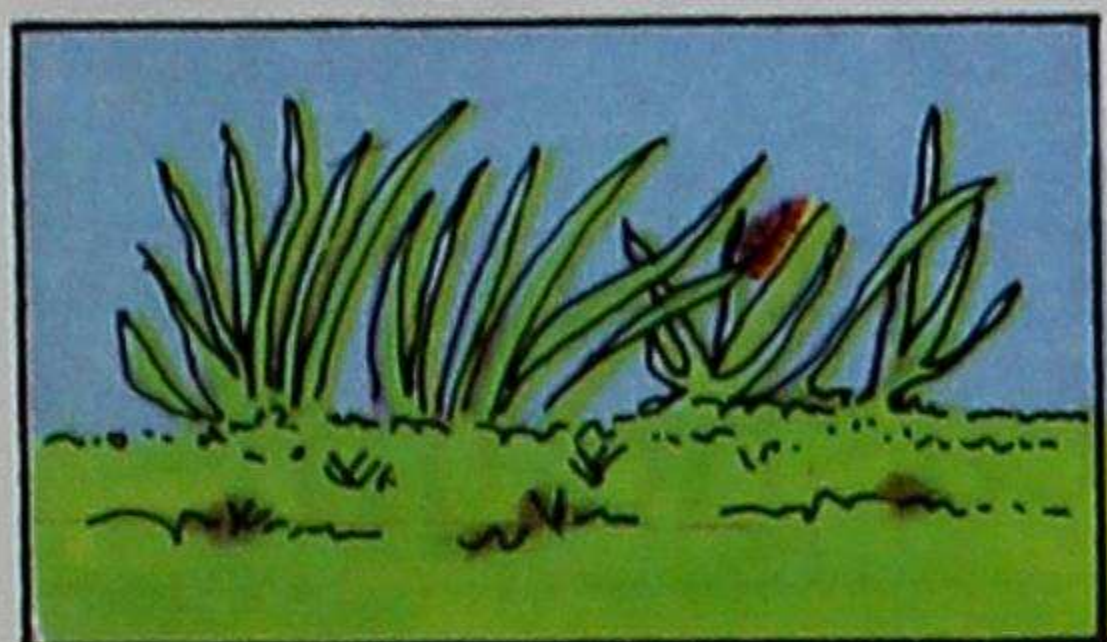

ucsha

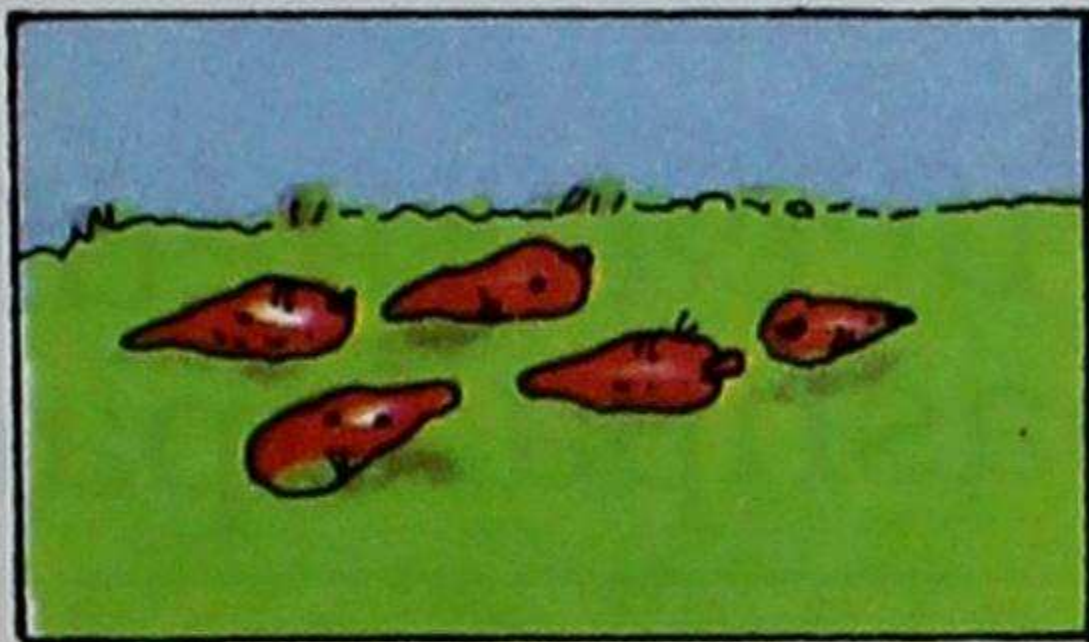

jicama

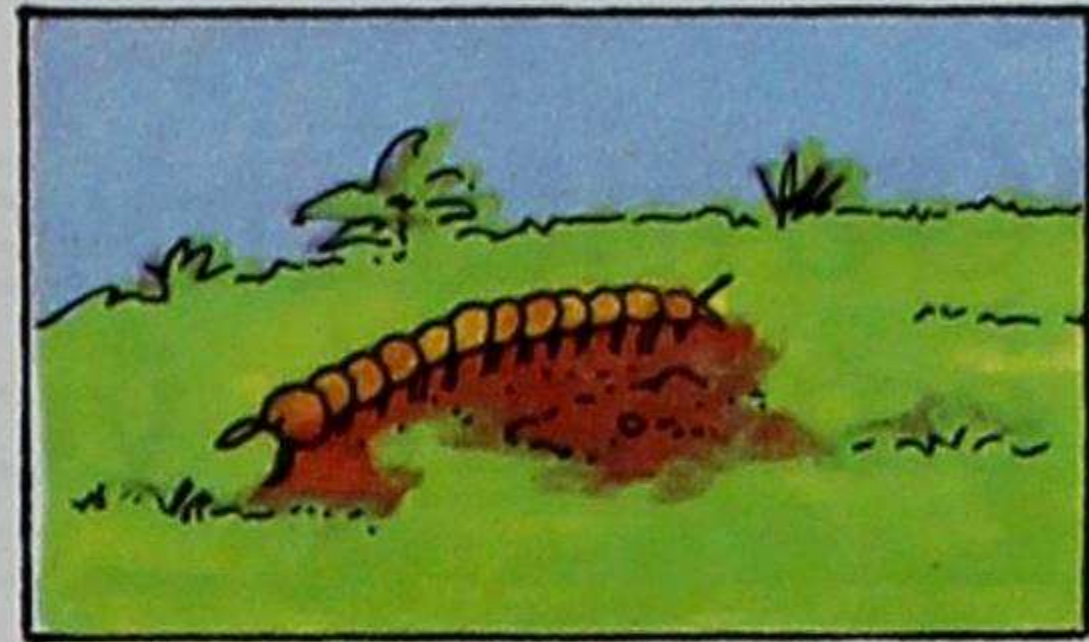

shiuai



i c h u

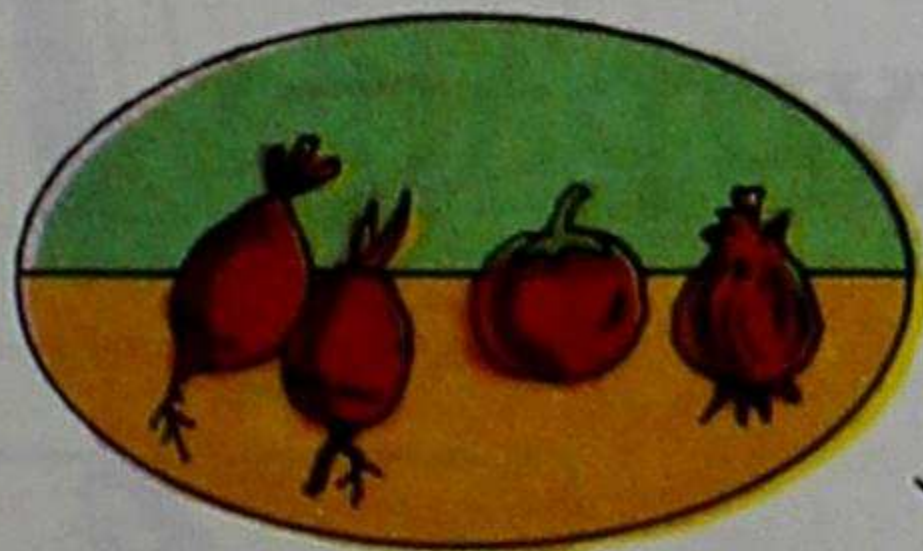

y u y u

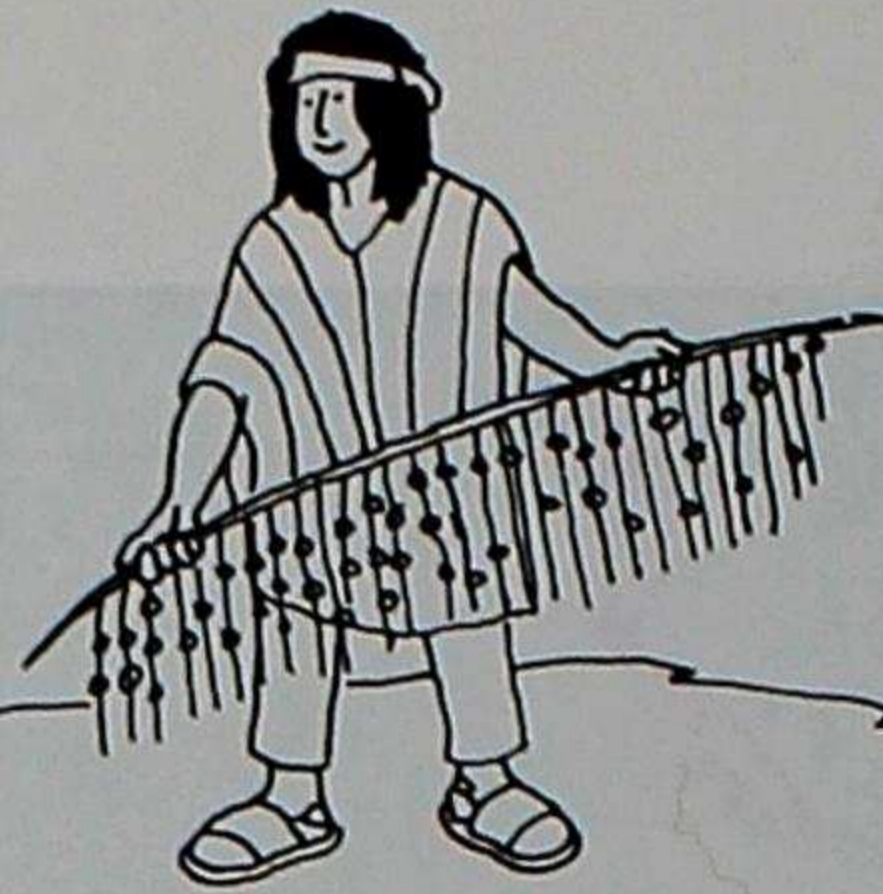
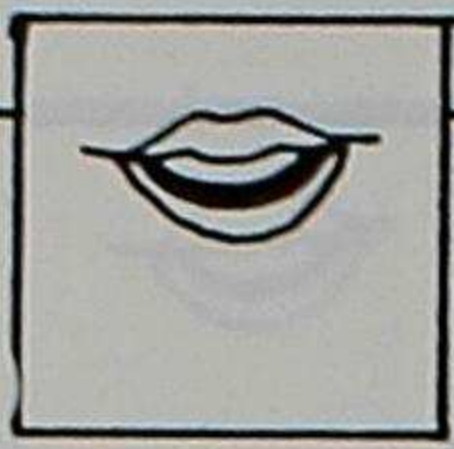

## Quipucamayucmanta

Quipucamayucca tucui incapac  
causaita yupashpa apac cashcami.

Quipucamayucca pucuc  
pachacunata, huihuacunata,  
yupashpami apac cashcami.

Quipuca shuc huatahca huasca  
mucucunahuan shinami cashca.  
Cai mucucunaca shuctac shuctac  
yupaicunapacmi cashca.

Quipucamayucca sumac yupaita  
yanapacmi cashca.

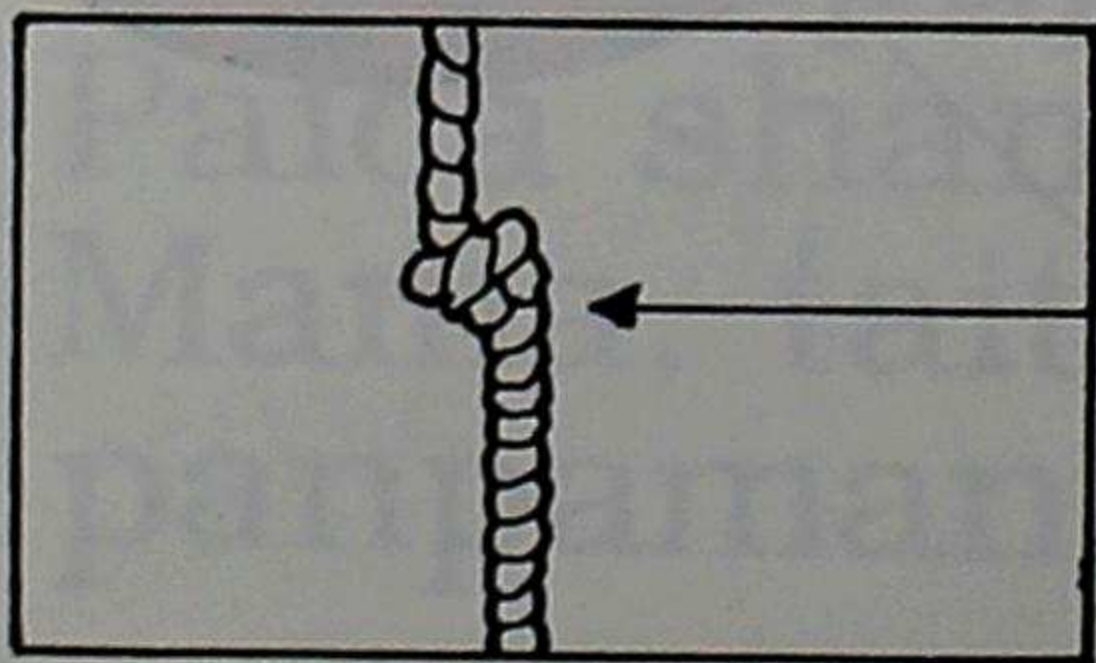

Quipumanta mucu

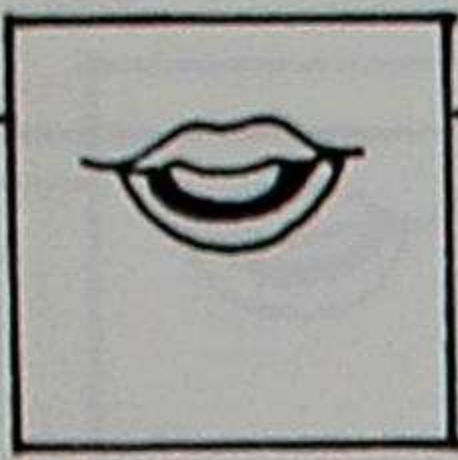

Chitaca quincha ucupimi  
shayacun.

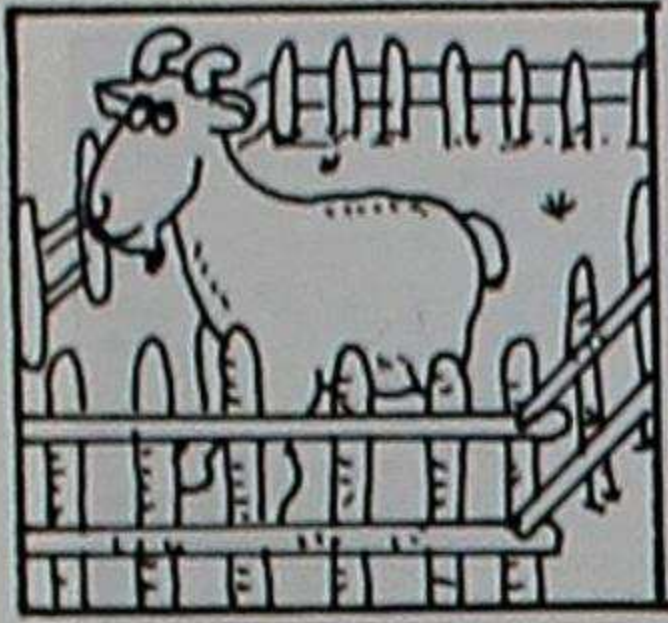

Chitaca canchapimi shayacun.

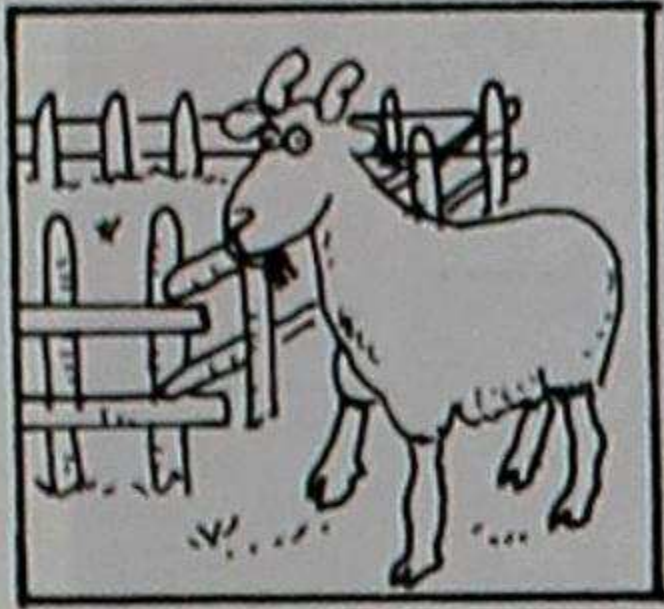

Mancapica achca papacuna  
tiyanmi.

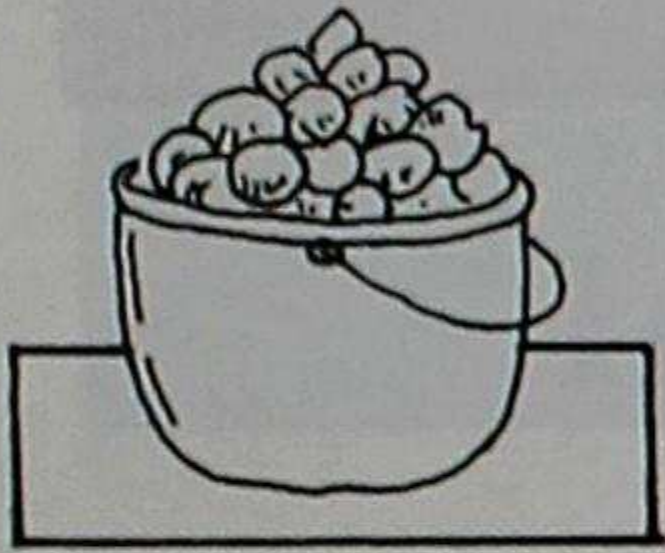

Mancapica asha papa tiyanmi.

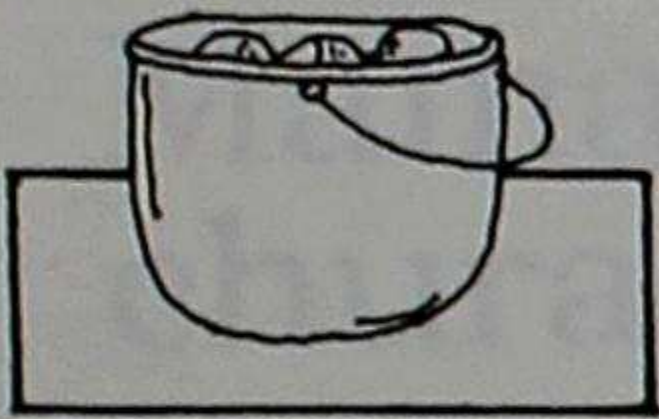

Taitaca huasiyucmi can.



Panica cuchiyucmi can.





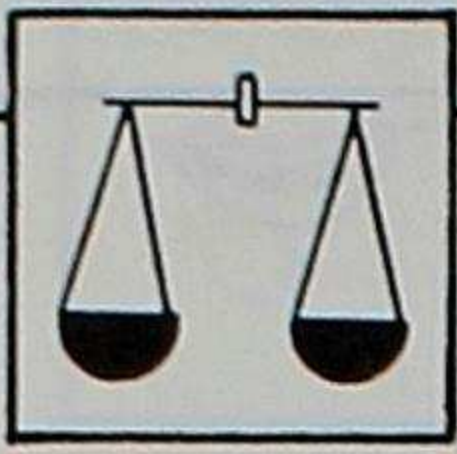

## **Huahuacunapac cushi causaimanta**

Ñucanchicca huahuacunami  
canchic.

Chaimanta taita mamacuna  
yachacchicuna, pushaccuna  
cuyaihuan yachachichun  
munanchicmi.

Mana huaccha huahua shina  
causaita munanchicchu.  
Huahuacunaca sumac cushi  
causaitami ninchic.

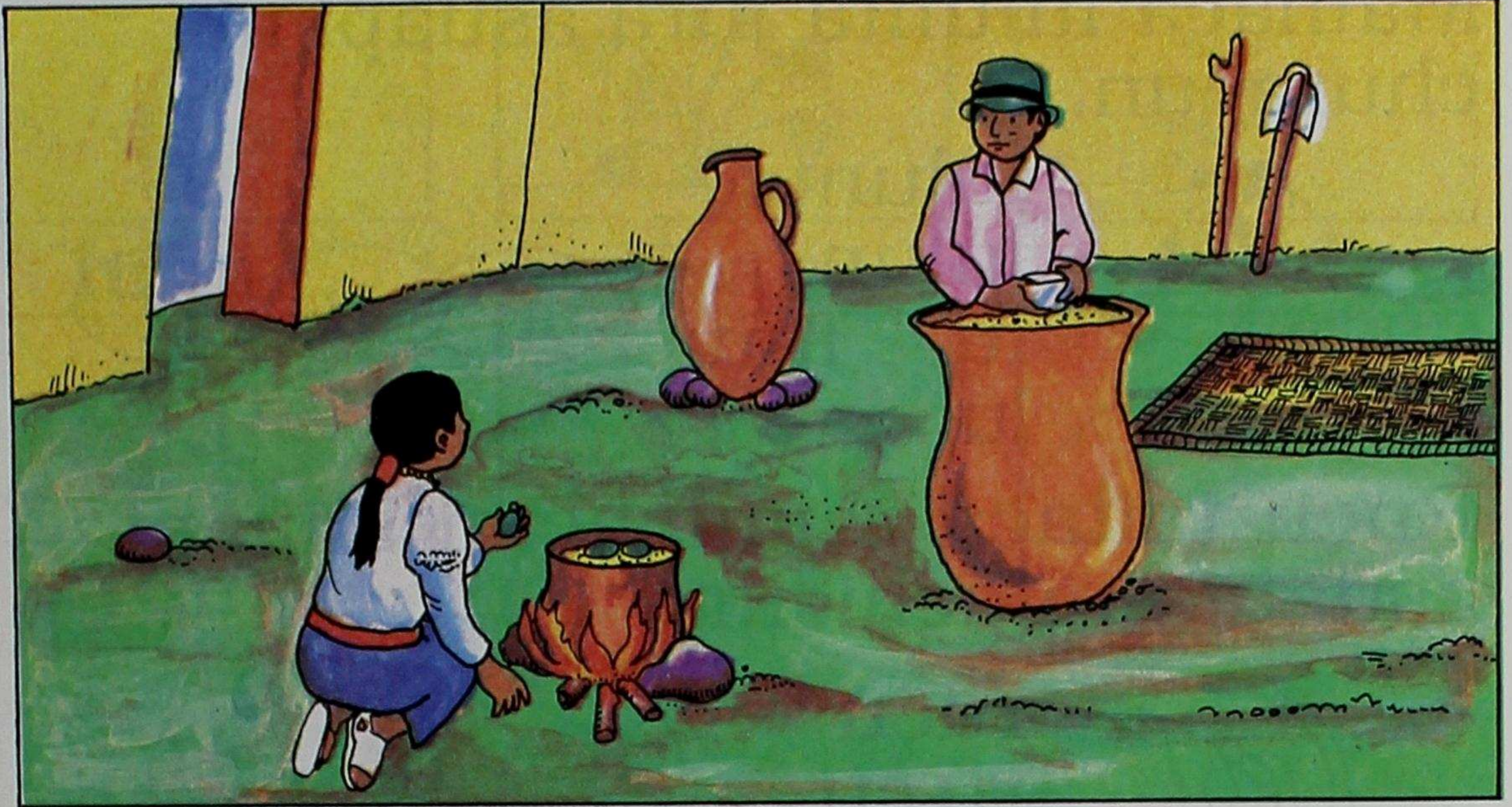
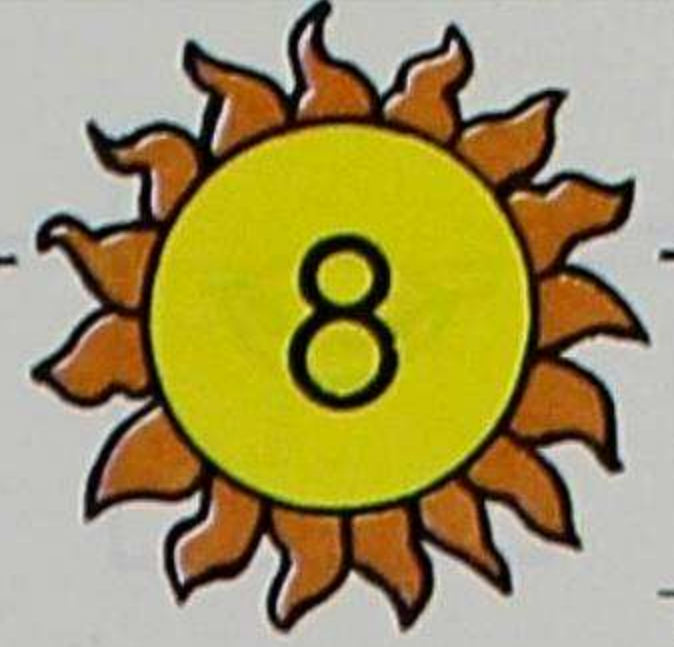
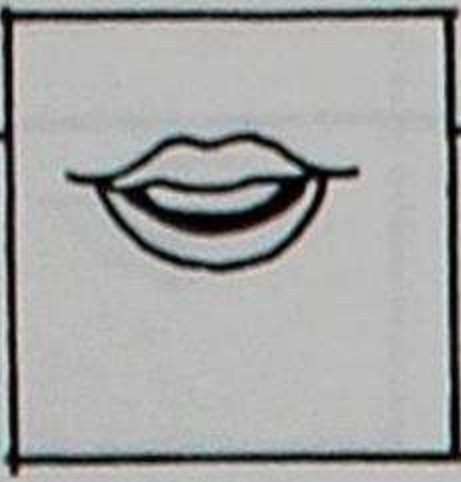

## Raimimanta

Mamaca lulunta jura asuapimi  
churacun.

Rucu taitaca raimipacmi 'shilapi  
asuata juntachicun.

Huacratapashmi raimipacca  
huañuchicun.

Huanpracunaca huancar,  
quipatapash taquicrin.

Chasnami raimipica sumacta  
tushucrin, asuatapash  
upiacrincuna.

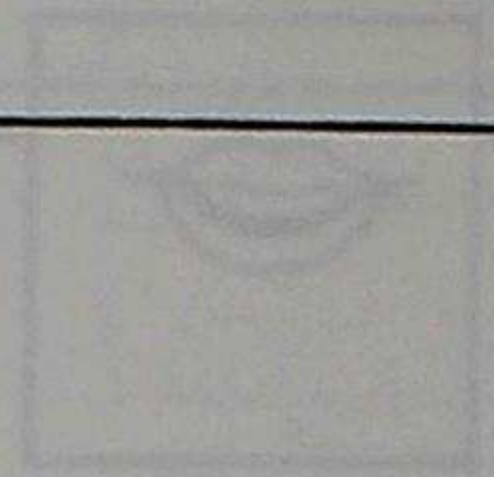
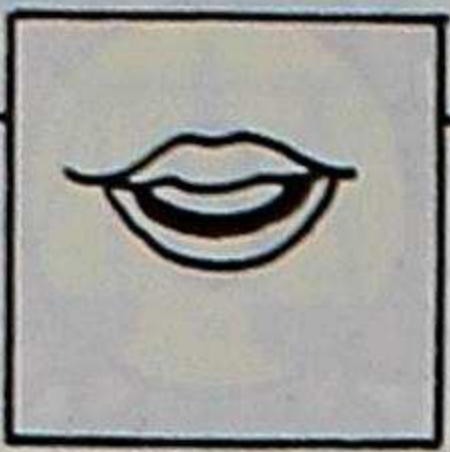

Mamaca lulunta jura asuapimi  
churacun.



lulunta  
lulun  
lu lun  
lu

lu li la  
[l] = [L]

Rucu taitaca raimipacmi shilapi  
asuata juntachicun.



rucu  
ru cu  
ru

ru ra ri  
[r] = [R]

Huacratapashmi raimipacca  
huañuchicun.

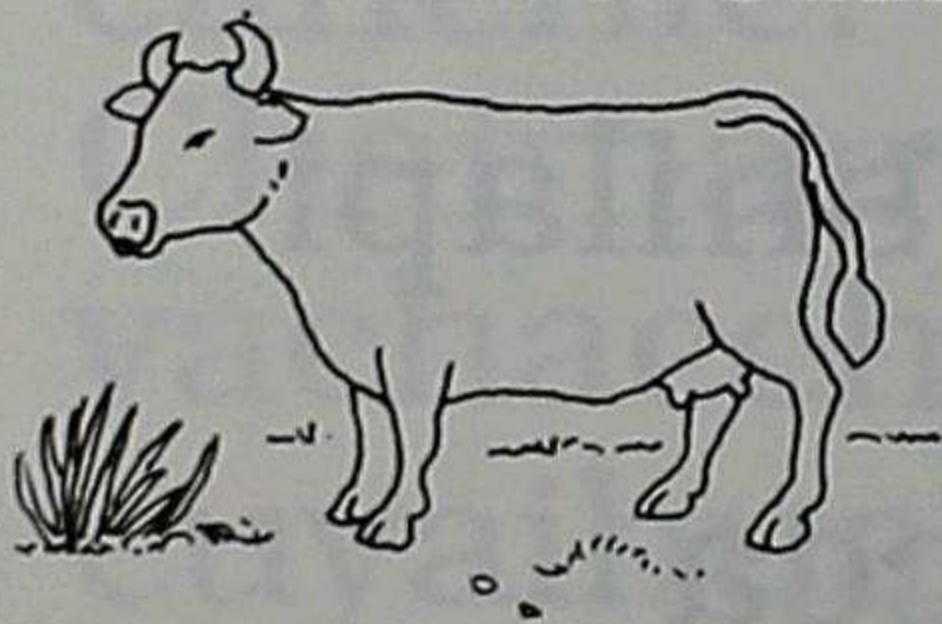

huacratapashmi  
huacra  
hua cra cra cri cru  
cra

Huanpracunaca huancar,  
quipatapash taquicrin.



huanpracunaca  
huanpra  
pra

pra

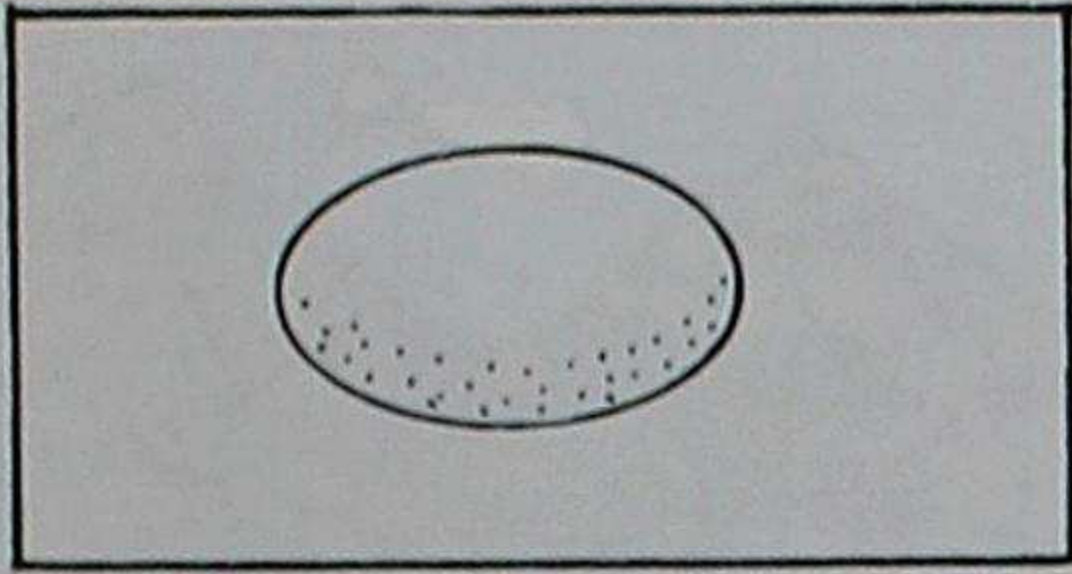
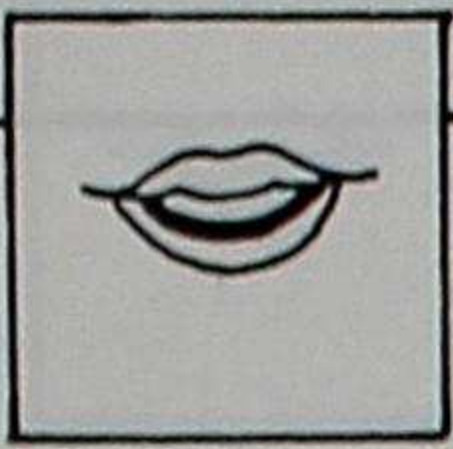

**lulun**

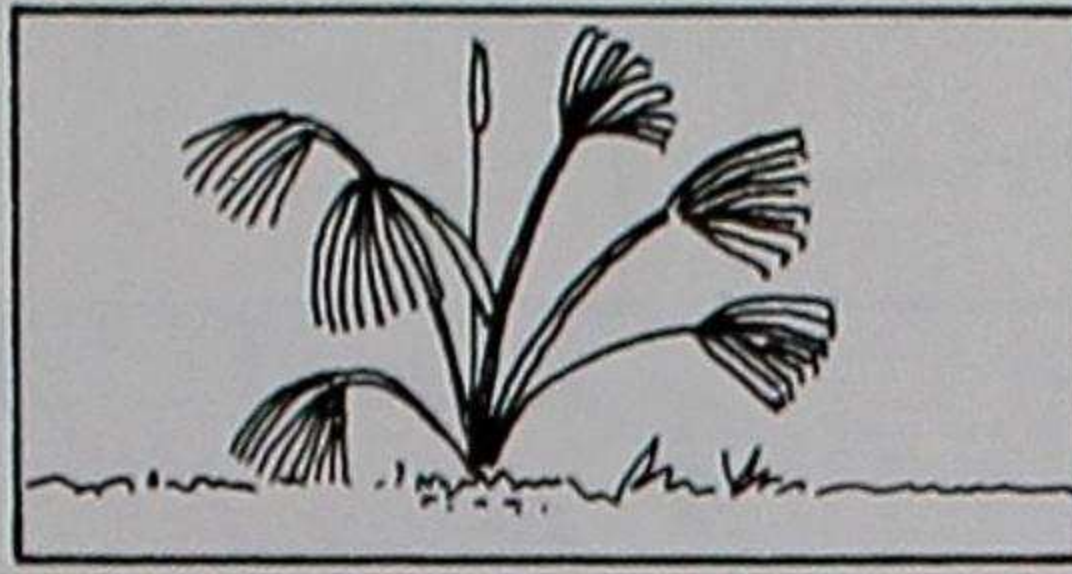

**lisan**

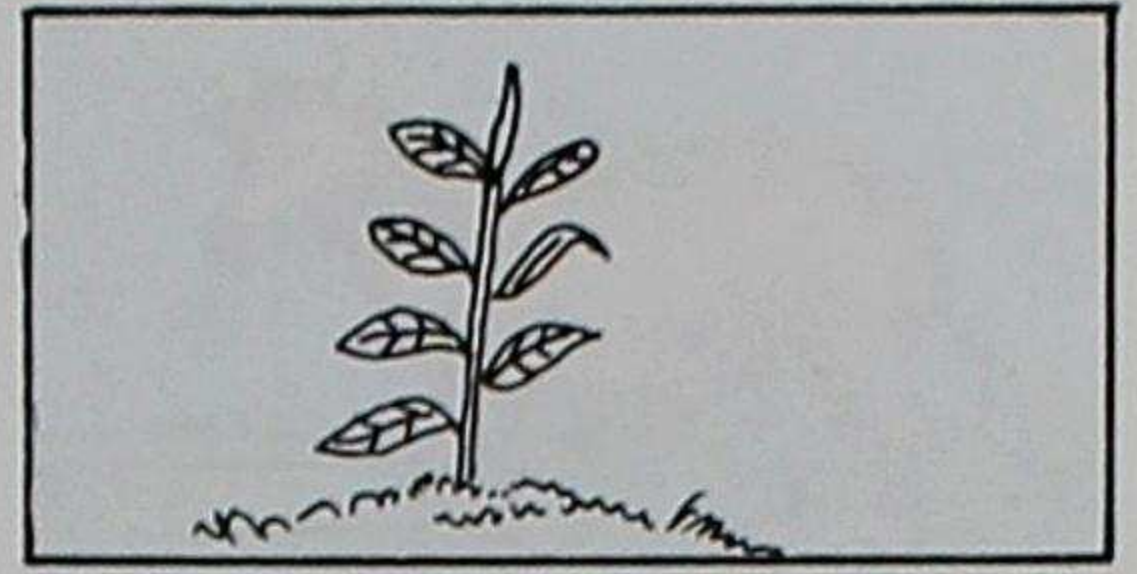

**lalu**

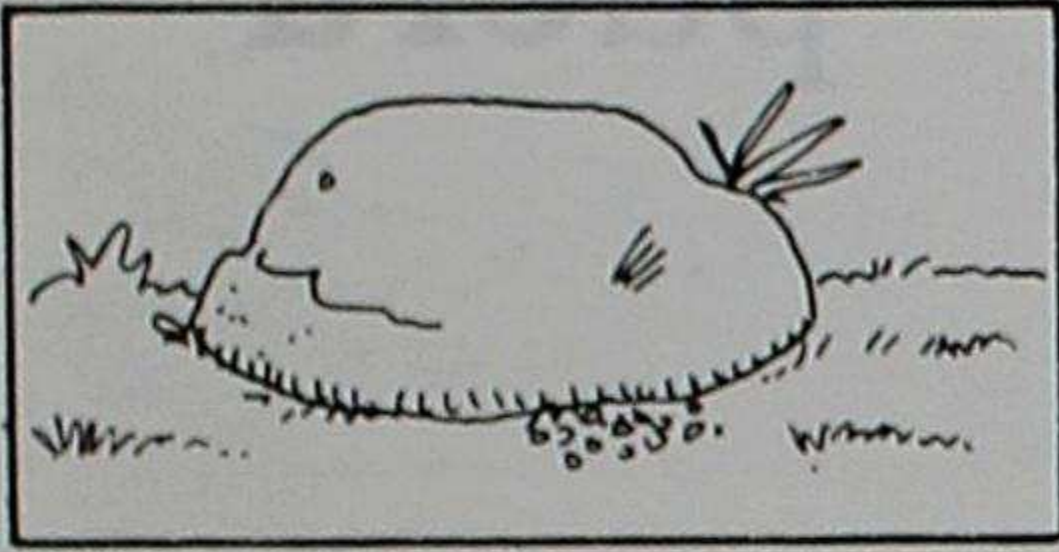

**rumi**

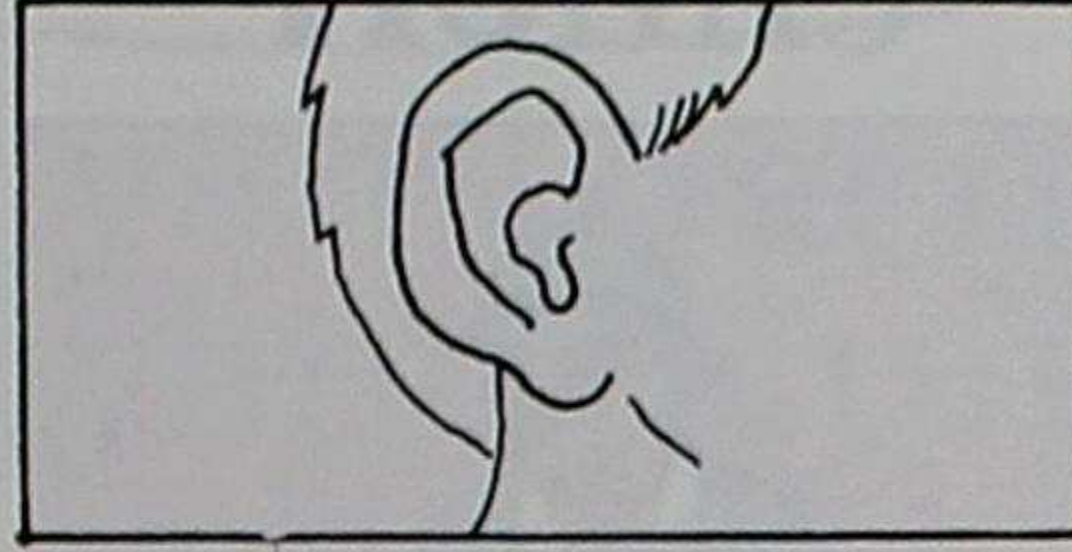

**rinri**

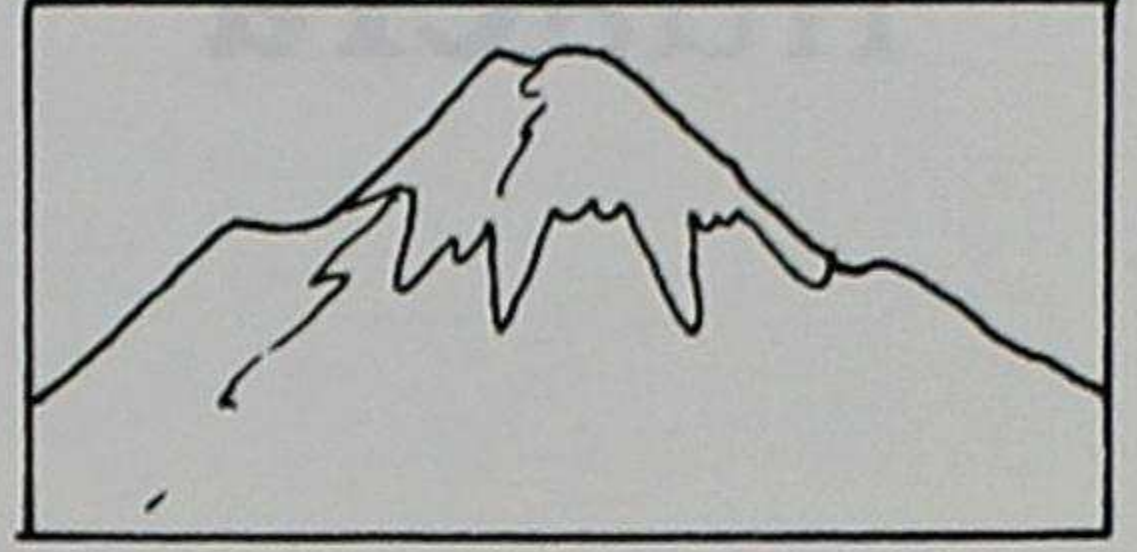

**rasu**

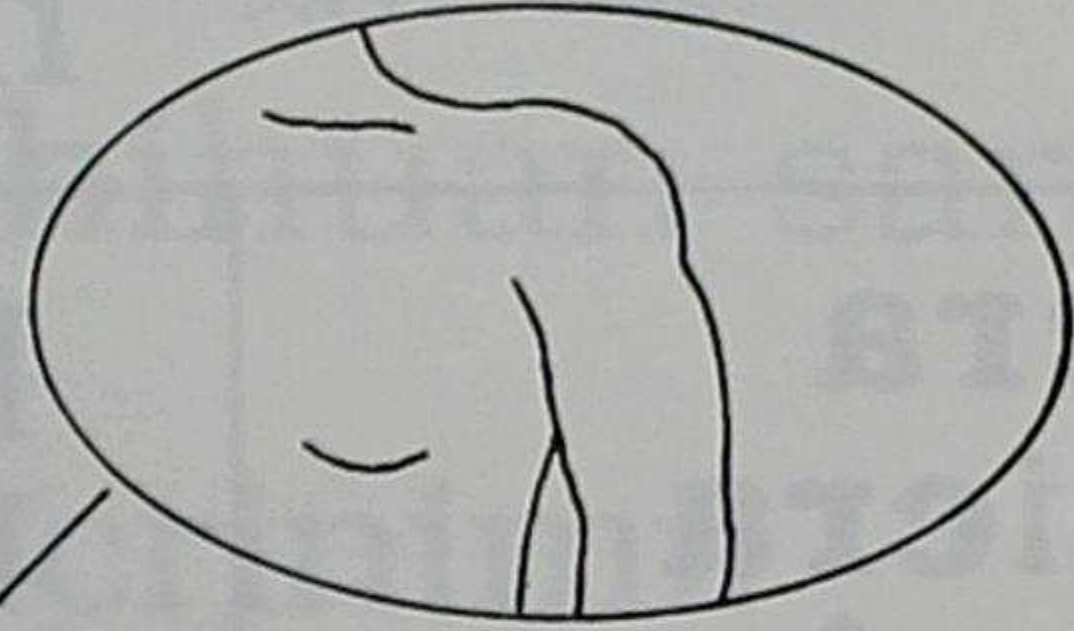
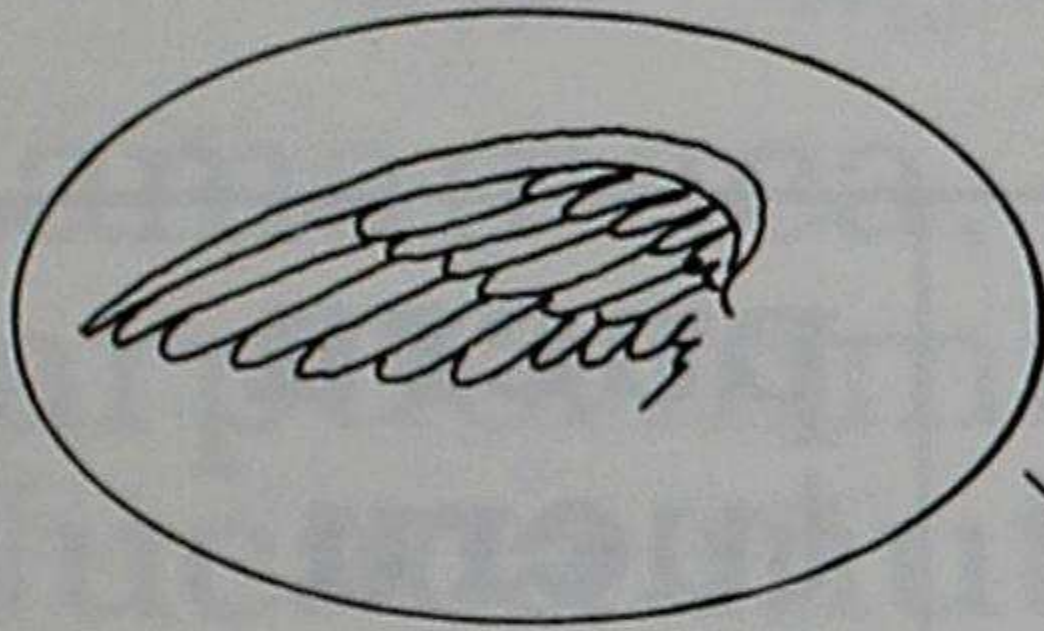

r i c r a

<b>lumu</b> <b>palu</b> <b>lulun</b> <b>culta</b>	<b>lisan</b> <b>quilicu</b> <b>linchi</b>	<b>lamama</b> <b>palanta</b> <b>palta</b> <b>laichu</b>
<b>ruca</b> <b>piruru</b> <b>runtu</b> <b>cururui</b>	<b>rimana</b> <b>curi</b> <b>rirpu</b> <b>chapariana</b>	<b>rasu</b> <b>yura</b> <b>rantina</b> <b>raimi</b>

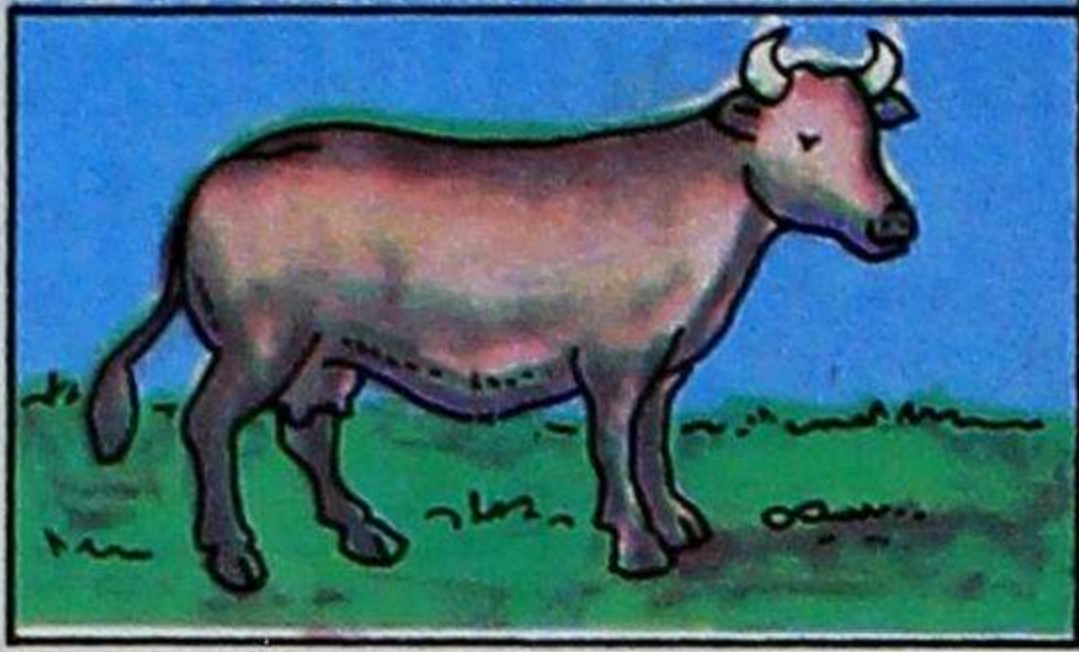
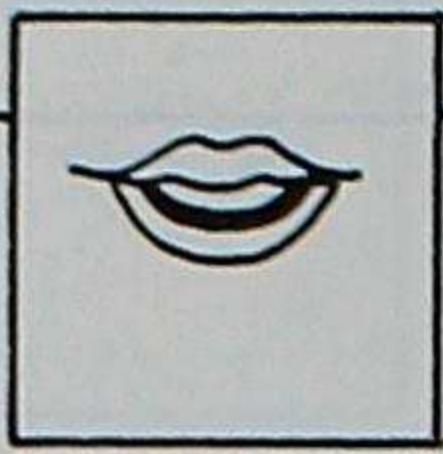

huacra

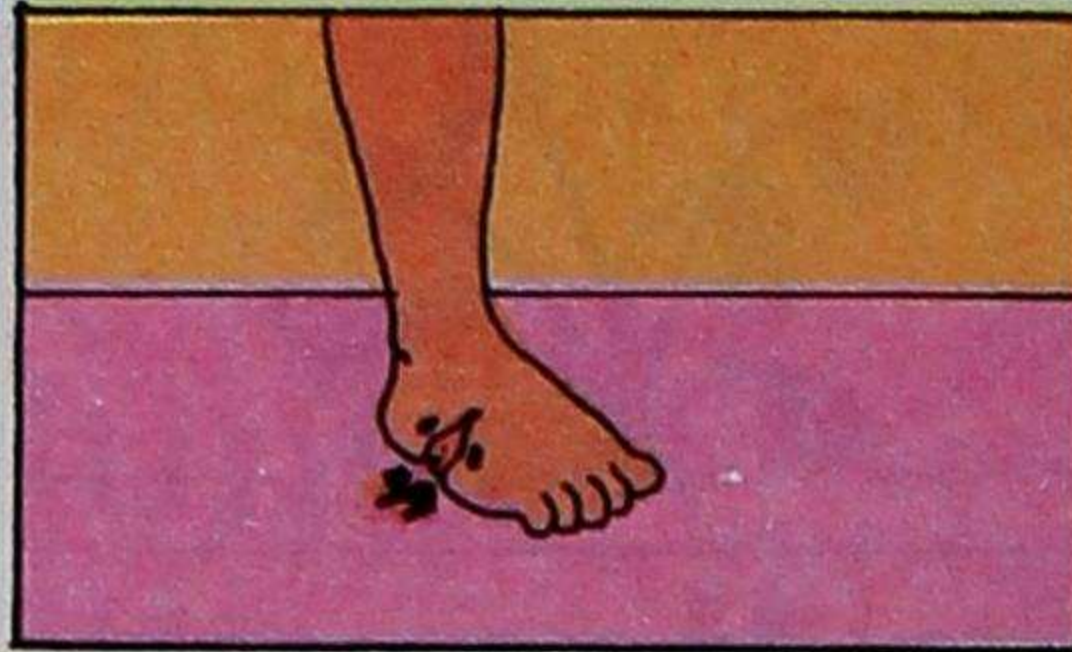

chucri

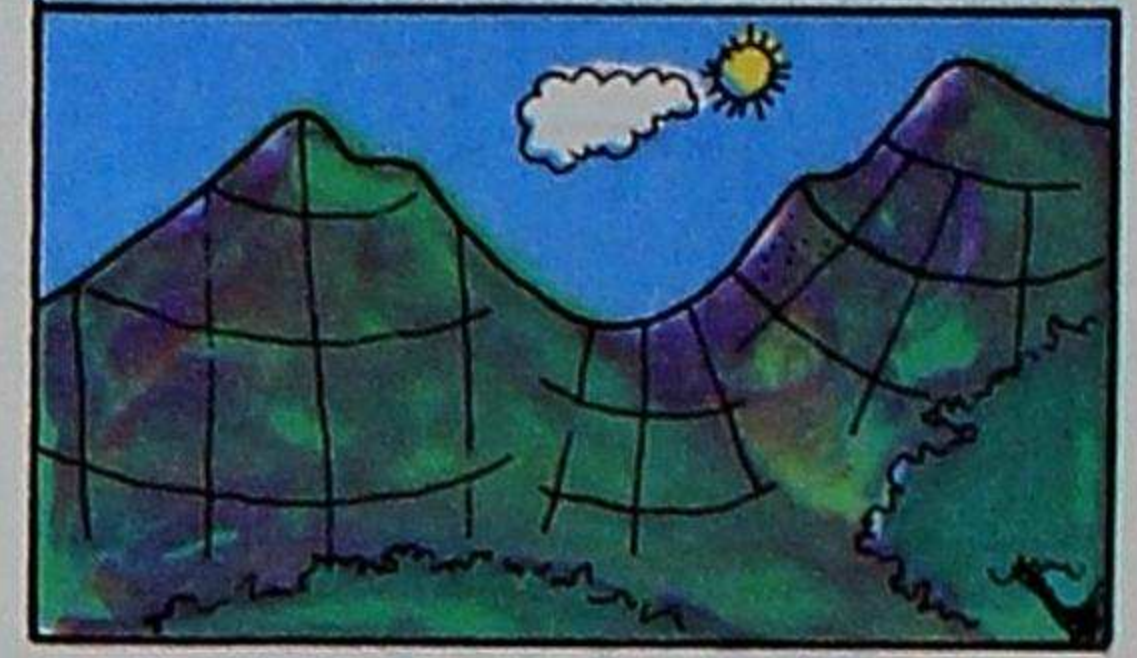

pucru



huanpra

<p>ricra shicra ticrai</p>	<p>puñucrí micucrí</p>	<p>pucru tucru</p>
------------------------------------	----------------------------	------------------------

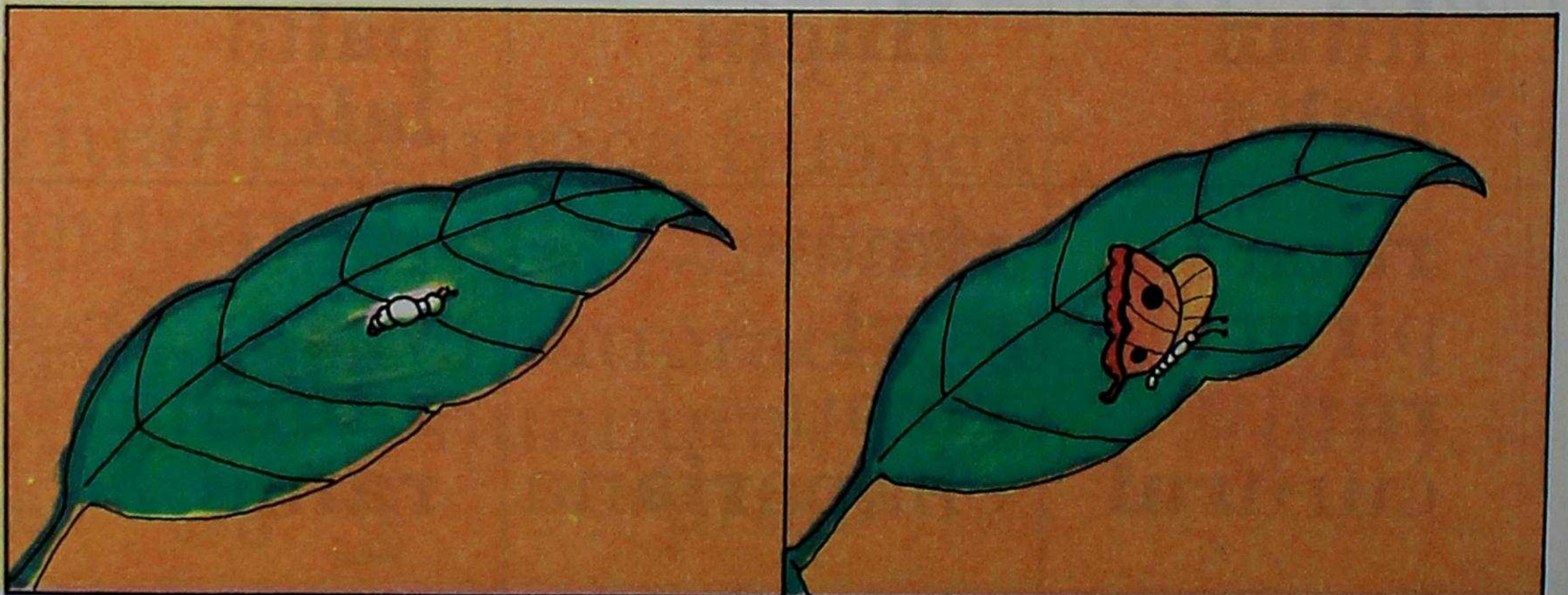
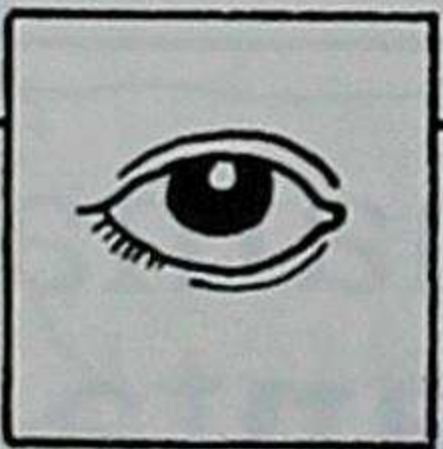



mama

**lamama**

yanuna

yanur**iacun**

yanur**icun**

yanur**cri**



- \* Lamamaca, laushushihuan sarata tarpucrinmi.
- \* Ñucaca mutita yanucrinimi.
- \* Chacrataca tucui punchami ricuriani.
- \* Mancapimi taurica yanuricun.



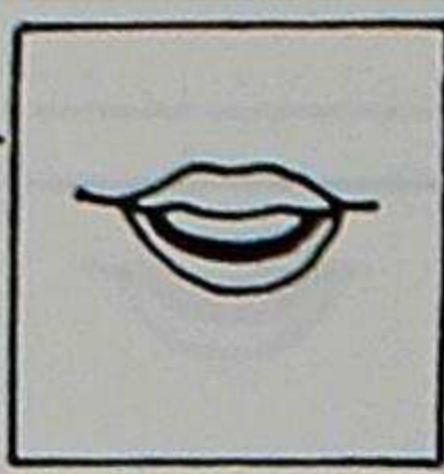

# yacumanta

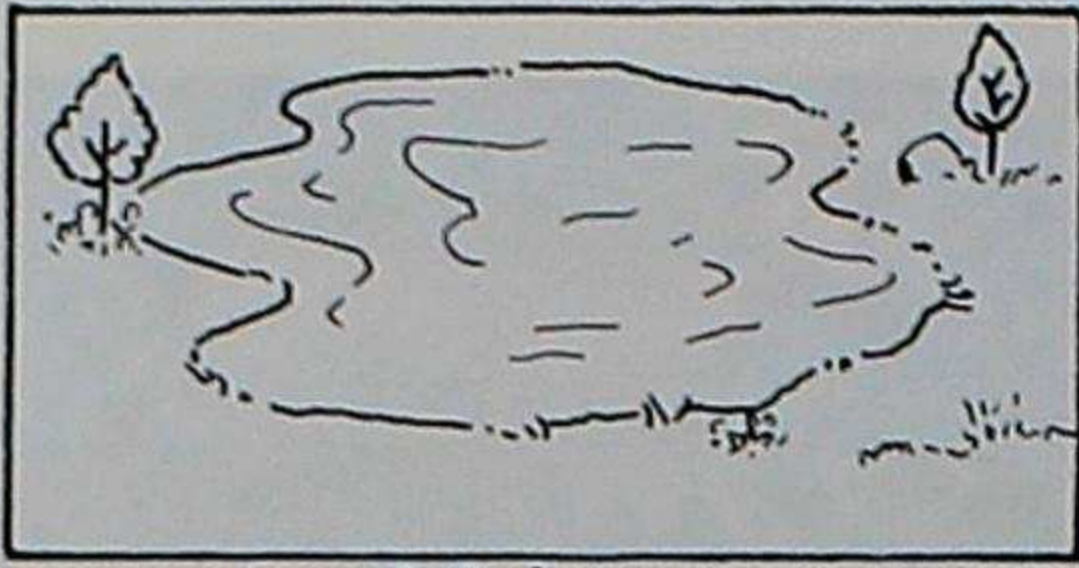

jita

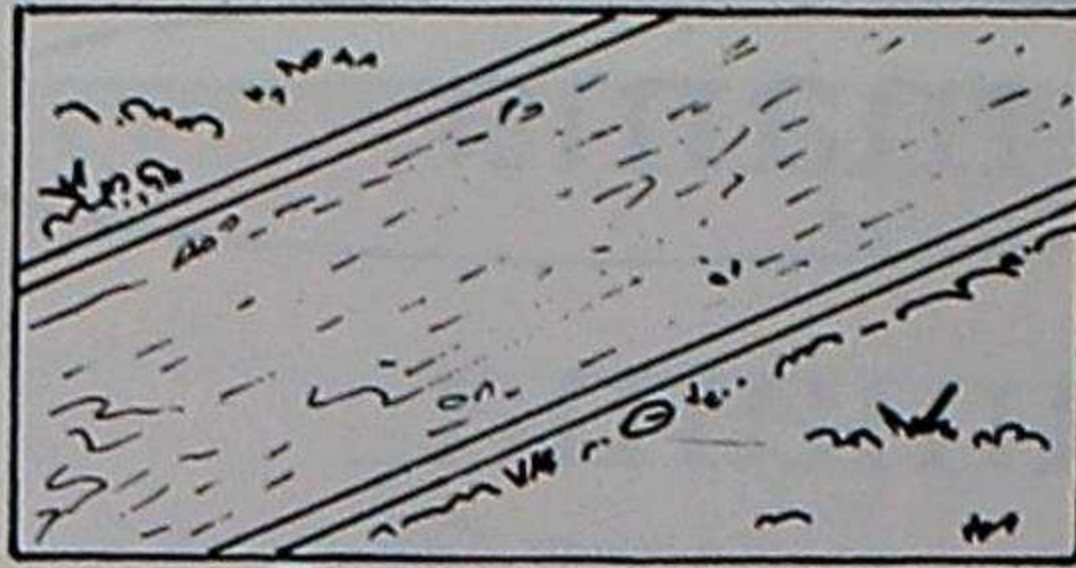

larca



mayu



mama cucha

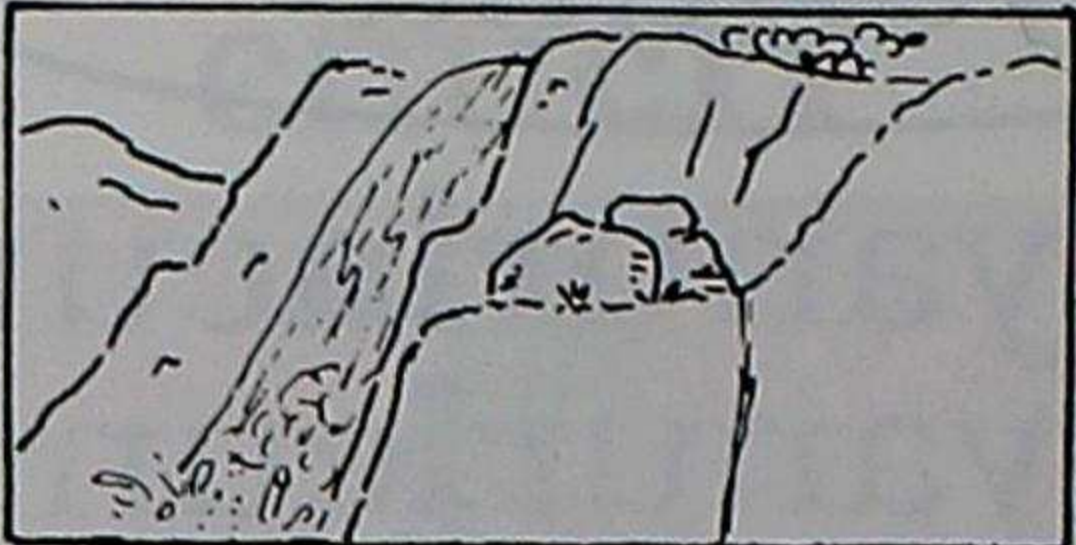

paccha

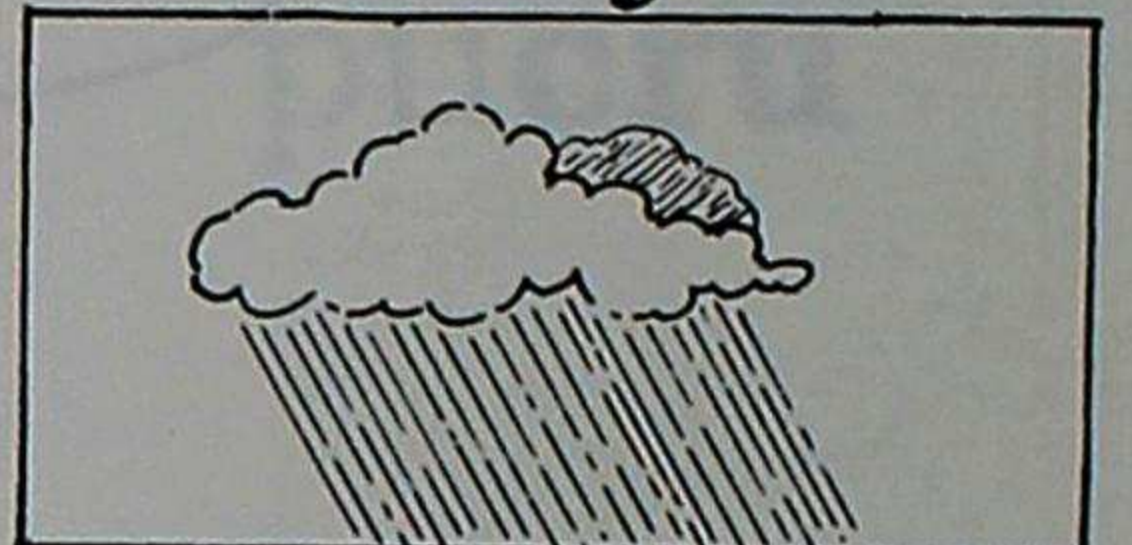

tamia

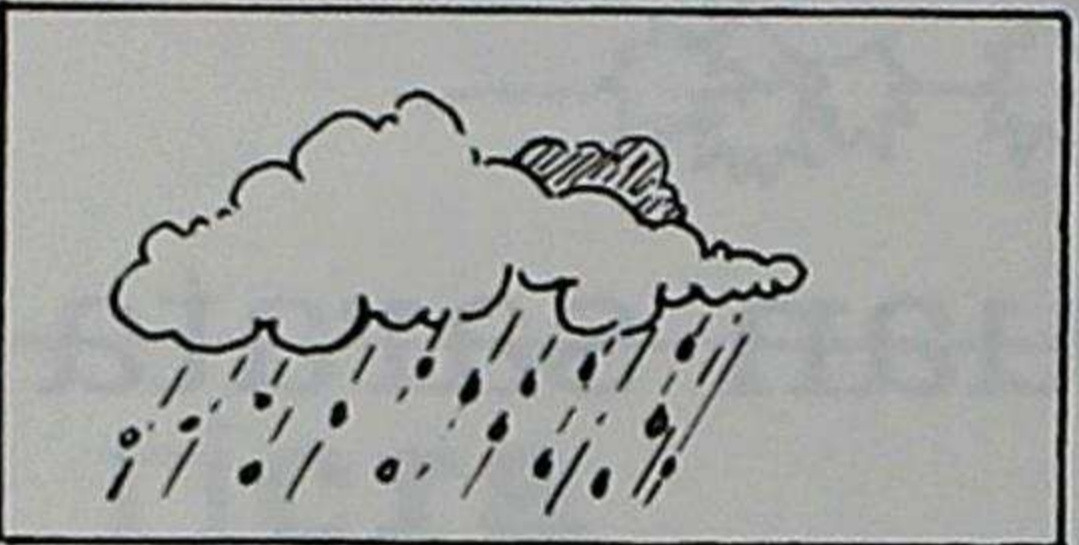

runtu

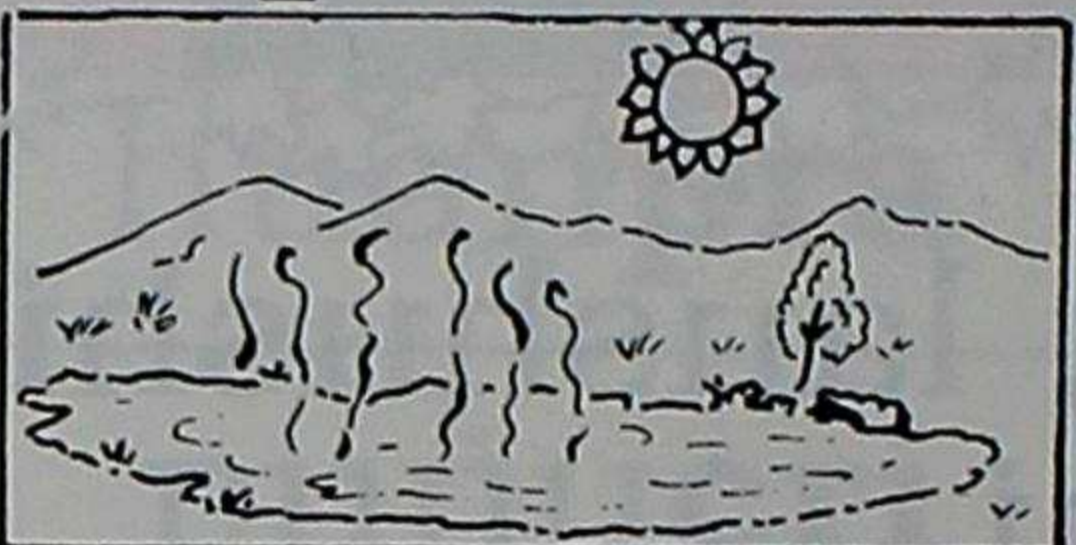

samai

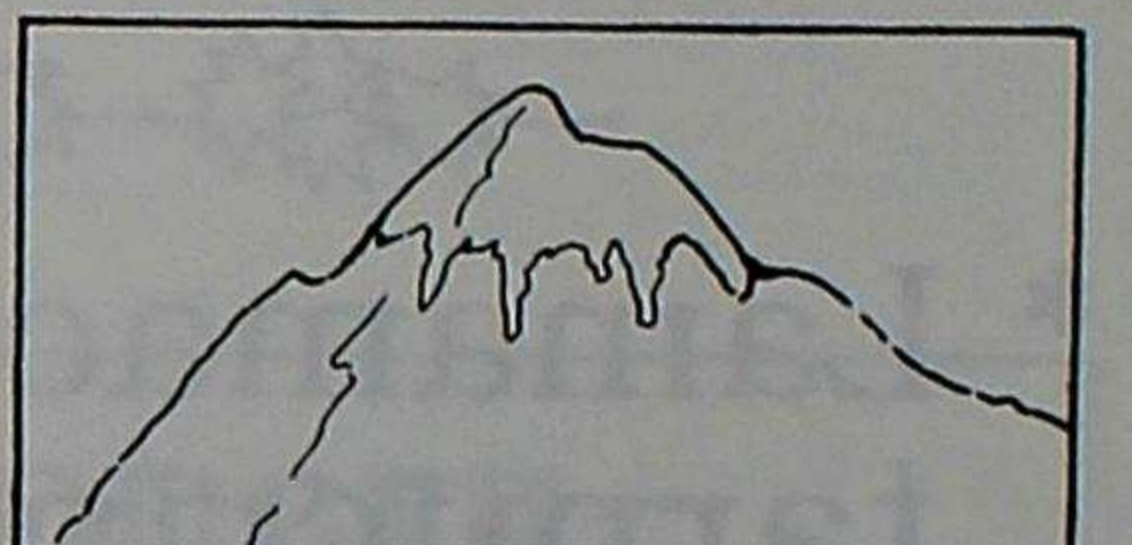

rasu

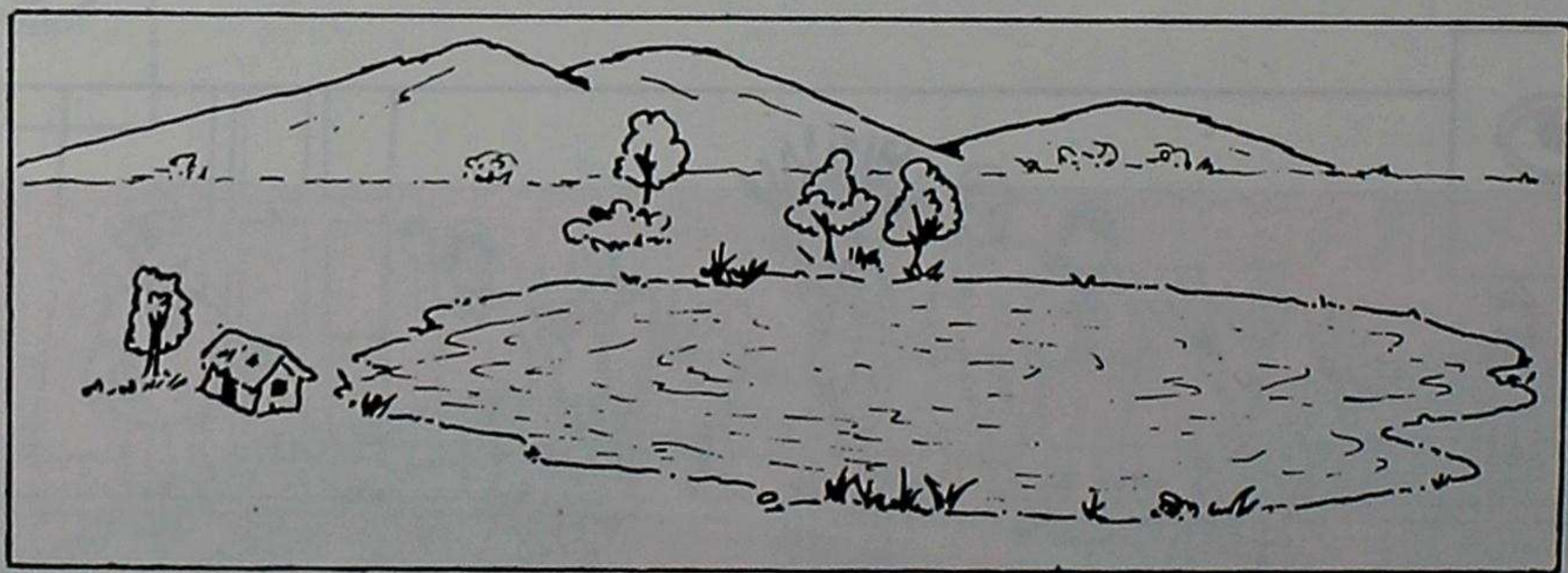
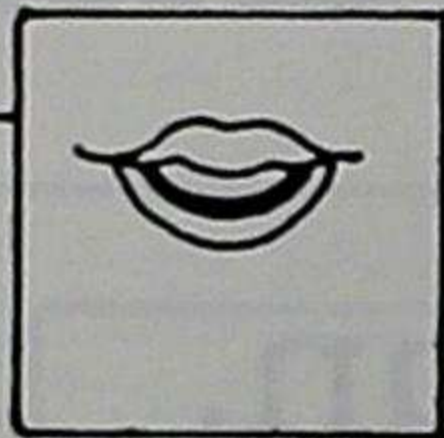

cucha

jita

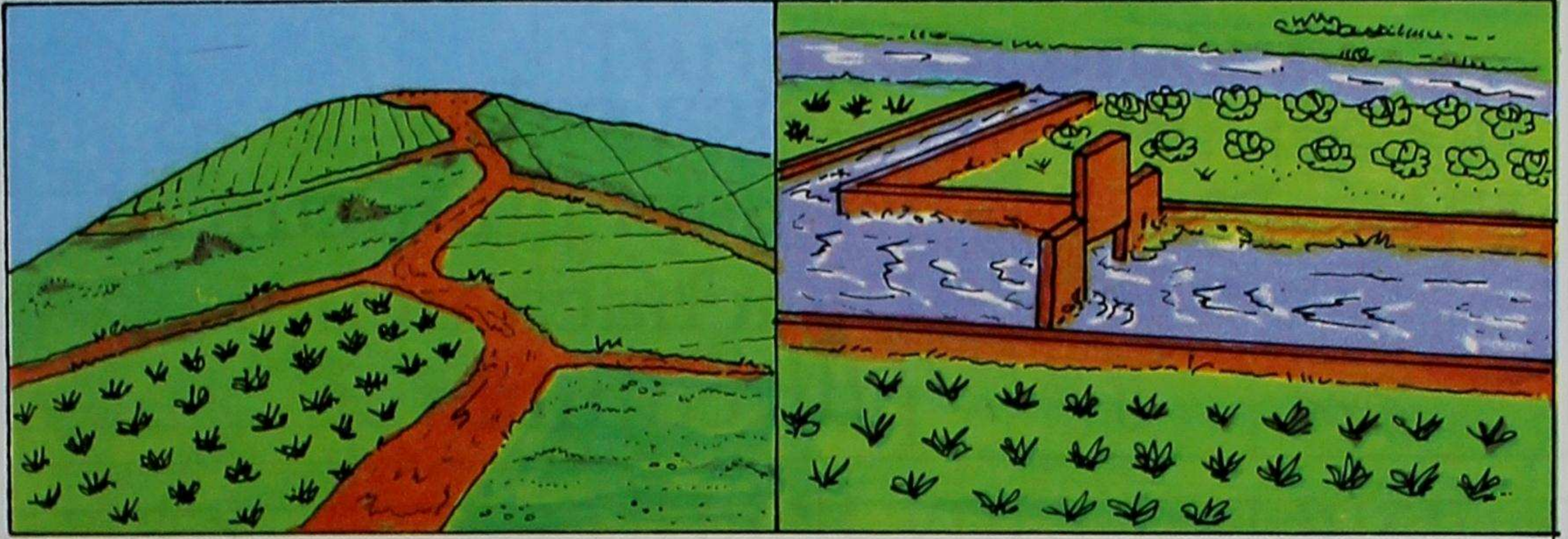

Ñaupa  
pachamanta

Cunan  
pachamanta

Ñucanchic ñaupa yayacunaca jatun  
larcacunatami rurashpa charic cashca.  
Incacuna huiracuchacunapash cai  
larcacunata ricushpaca mancharishpa  
saquirishcami.

yacuca cuchamanta, pucyumanta,  
mayumantapashmi parcuncapac  
apamuccuna cashca.

Shinami murucunataca sumacta  
pucuchiccuna cashca.

Cai larcacunapi, yacuta apamushpami,  
cunan pachacunapash jichanchic.



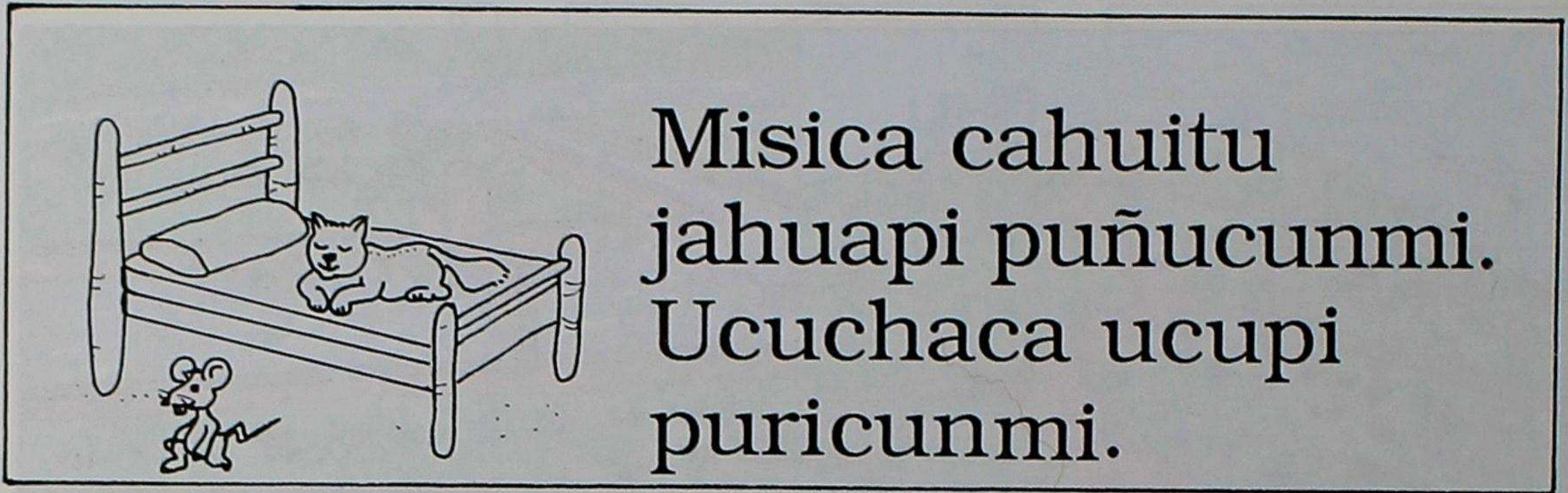
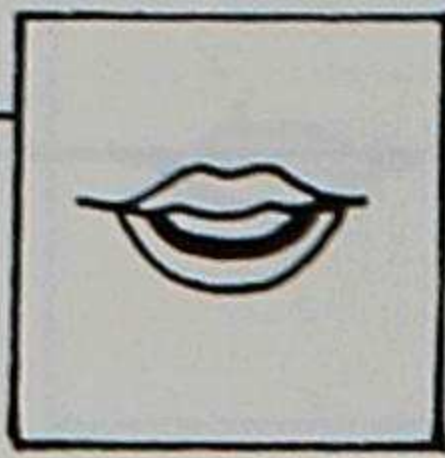

Misica cahuitu  
 jahuapi puñucunmi.  
 Ucuchaca ucupi  
 puricunmi.

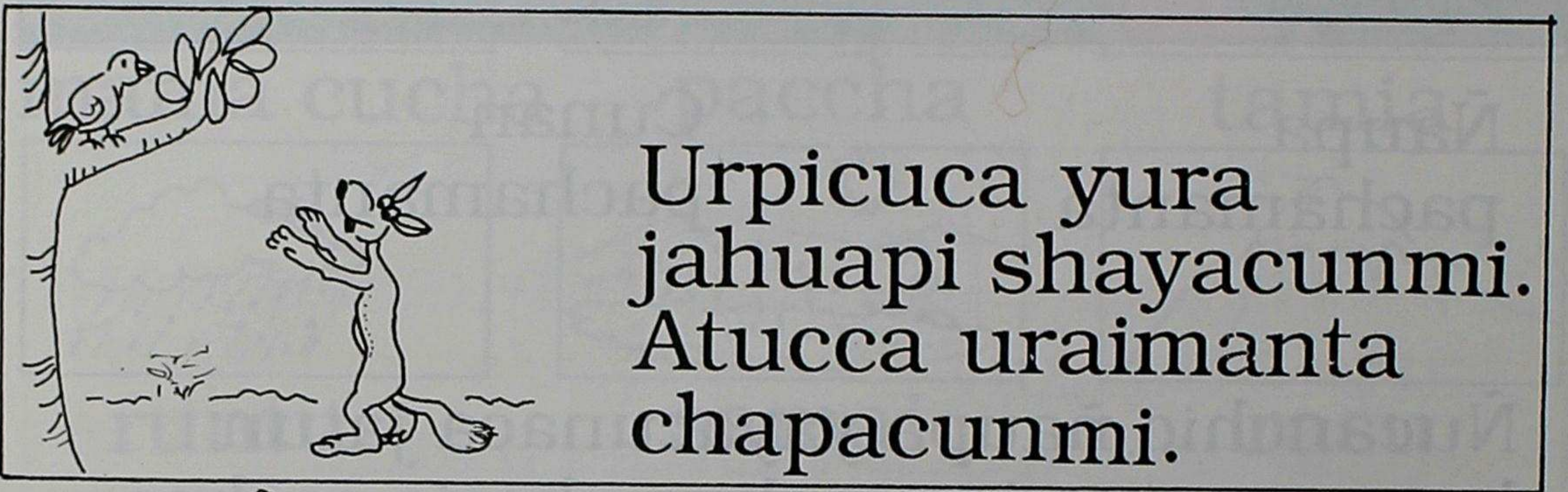

Urpicuca yura  
 jahuapi shayacunmi.  
 Atucca uraimanta  
 chapacunmi.

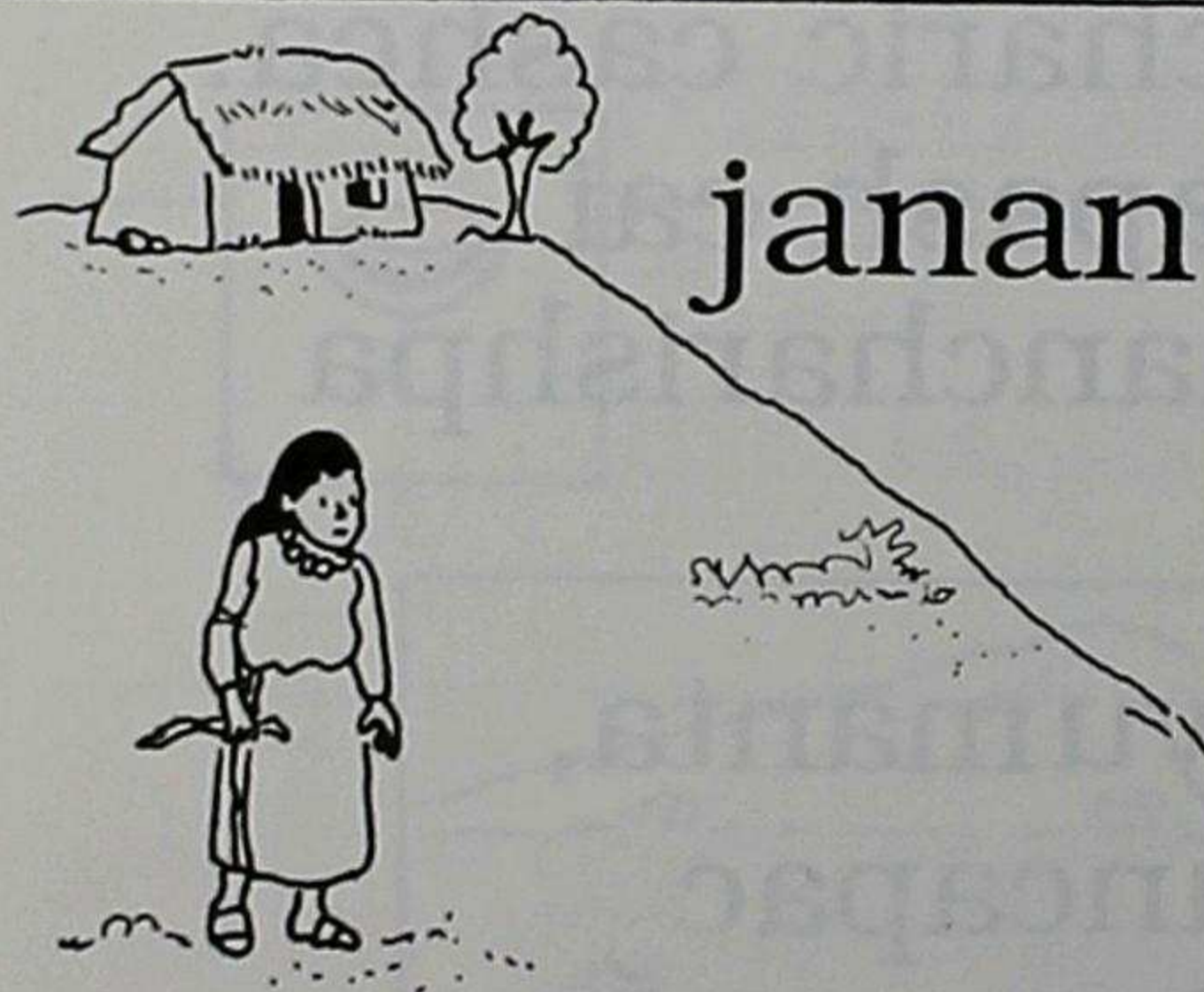

janan

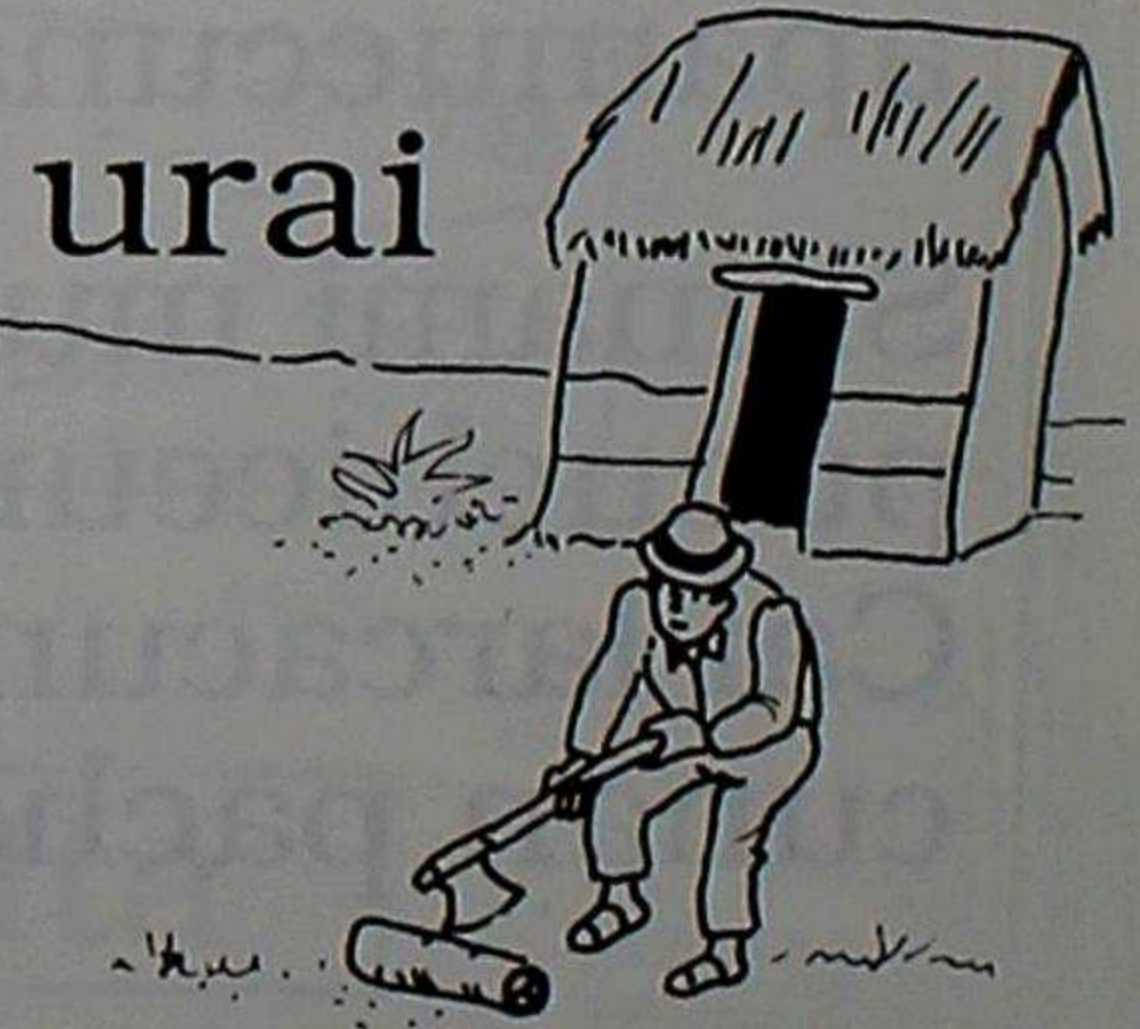

urai

Mamaca janana huasipimi  
 causan.  
 Churica urai huasipimi  
 causan.

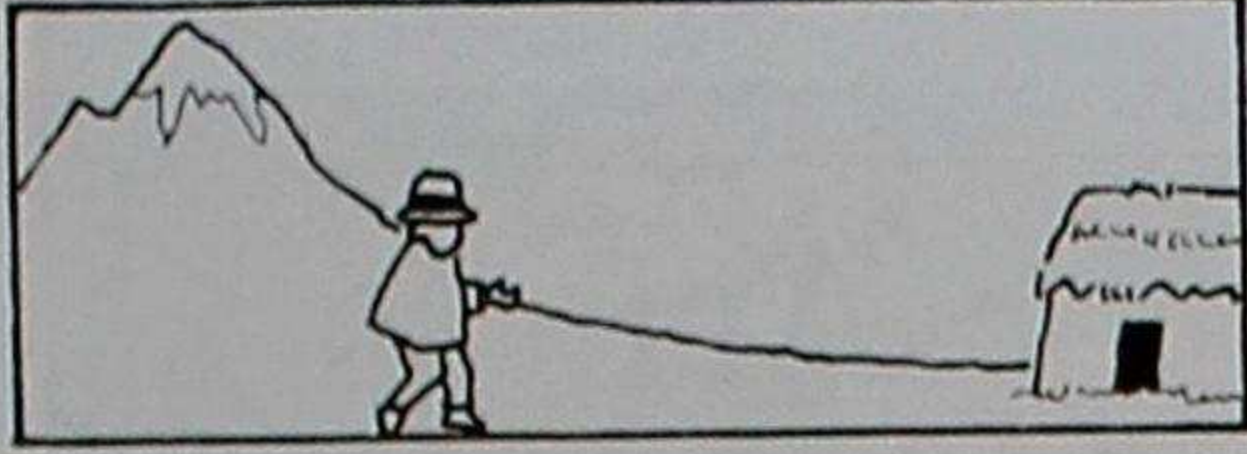
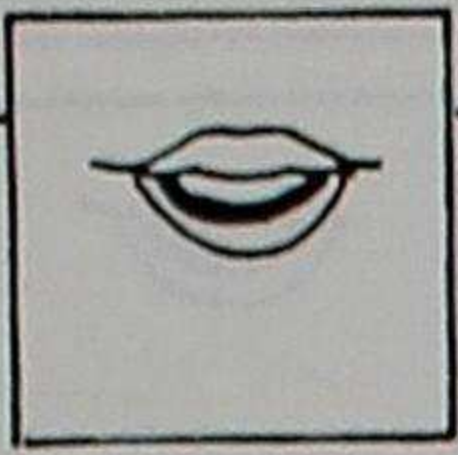

Turica urcumanta  
huasiman rin.

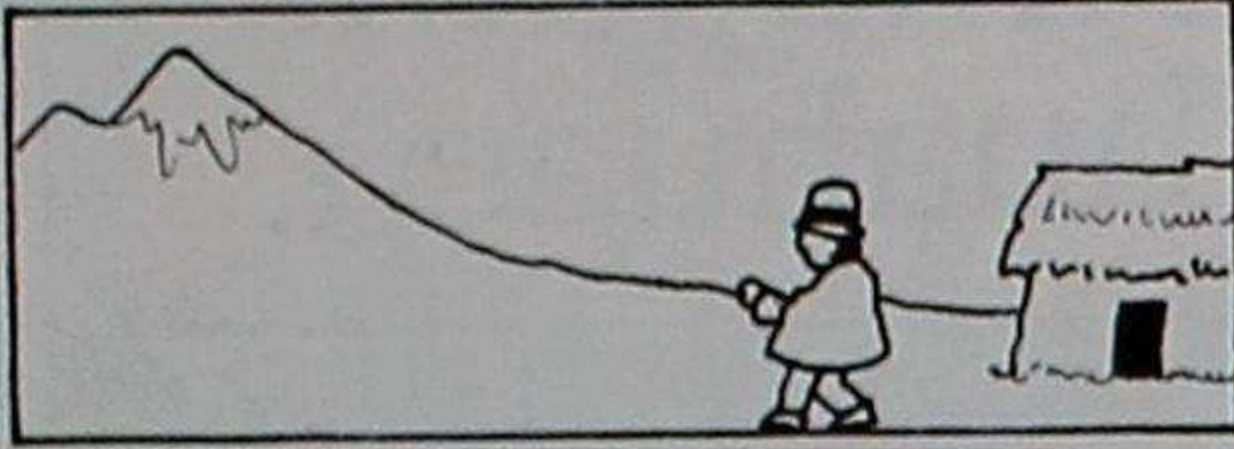

Turica huasimanta  
urcuman rin.

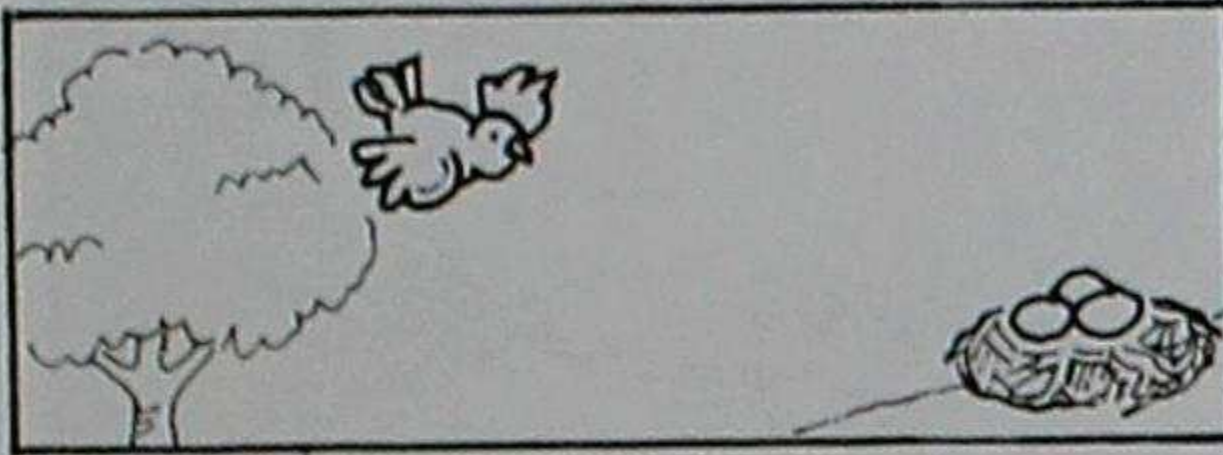

Urpica yura umamanta  
quishaman pahuan.

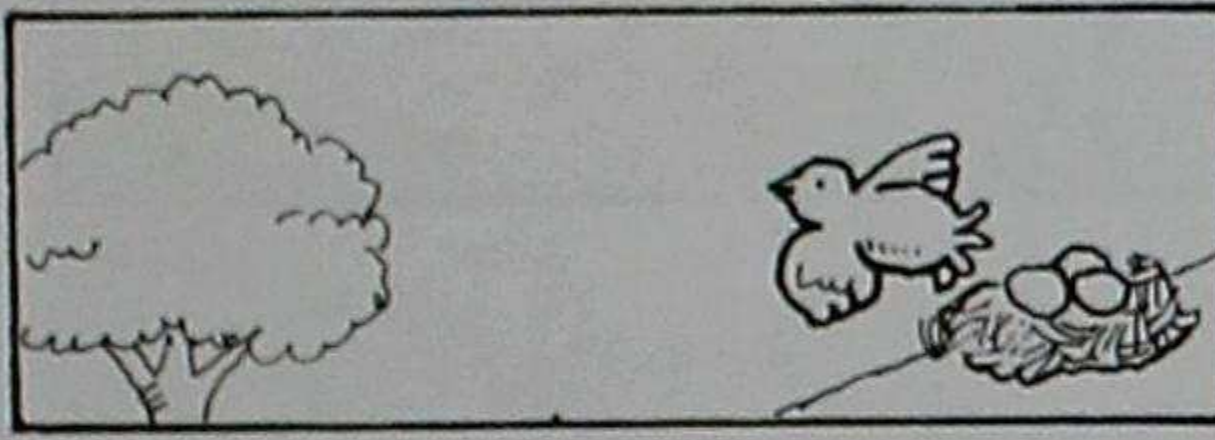

Urpica quishamanta  
yura umaman pahuan.

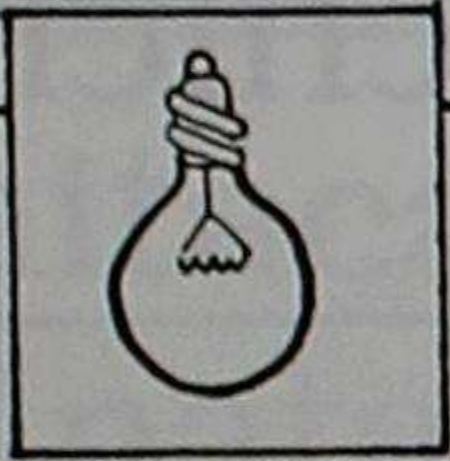

## Imashi imashi?

Rupaimantami samai tucuni.

Shinami jahuaman rini.

Puyumanta tamia tucushpami  
uraiman urmamuni.

Chirimanta rasu runtupash tucuni.

Mayuta cuchatapash ruranmi.

Runacunata, huihuacunata,

yuracunata, tucui

causaccunatapash yanapani.

Imashi cani?

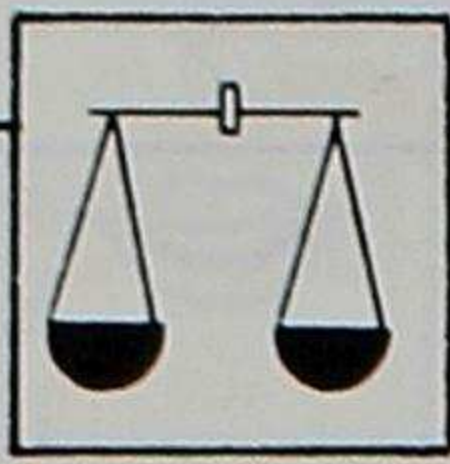

# Rimaimanta

Ñucapac  
yuyaita rimasha  
nini.

Ari,  
rimapailla  
huahuacu.



Ñucanchic yuyaicunata  
rucucunaca uyachun munanchicmi.

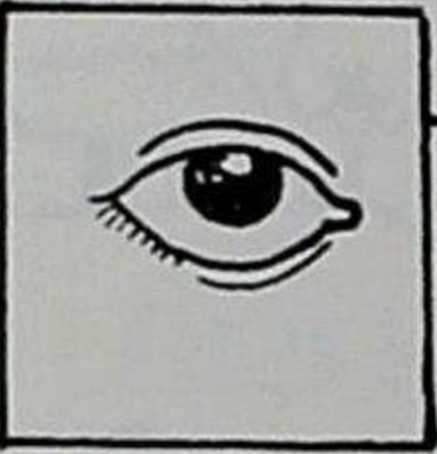

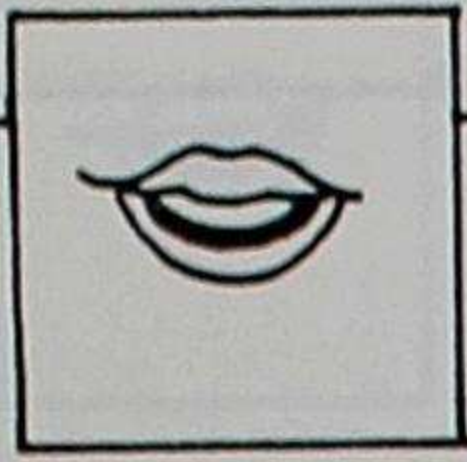

# Yanapaimanta

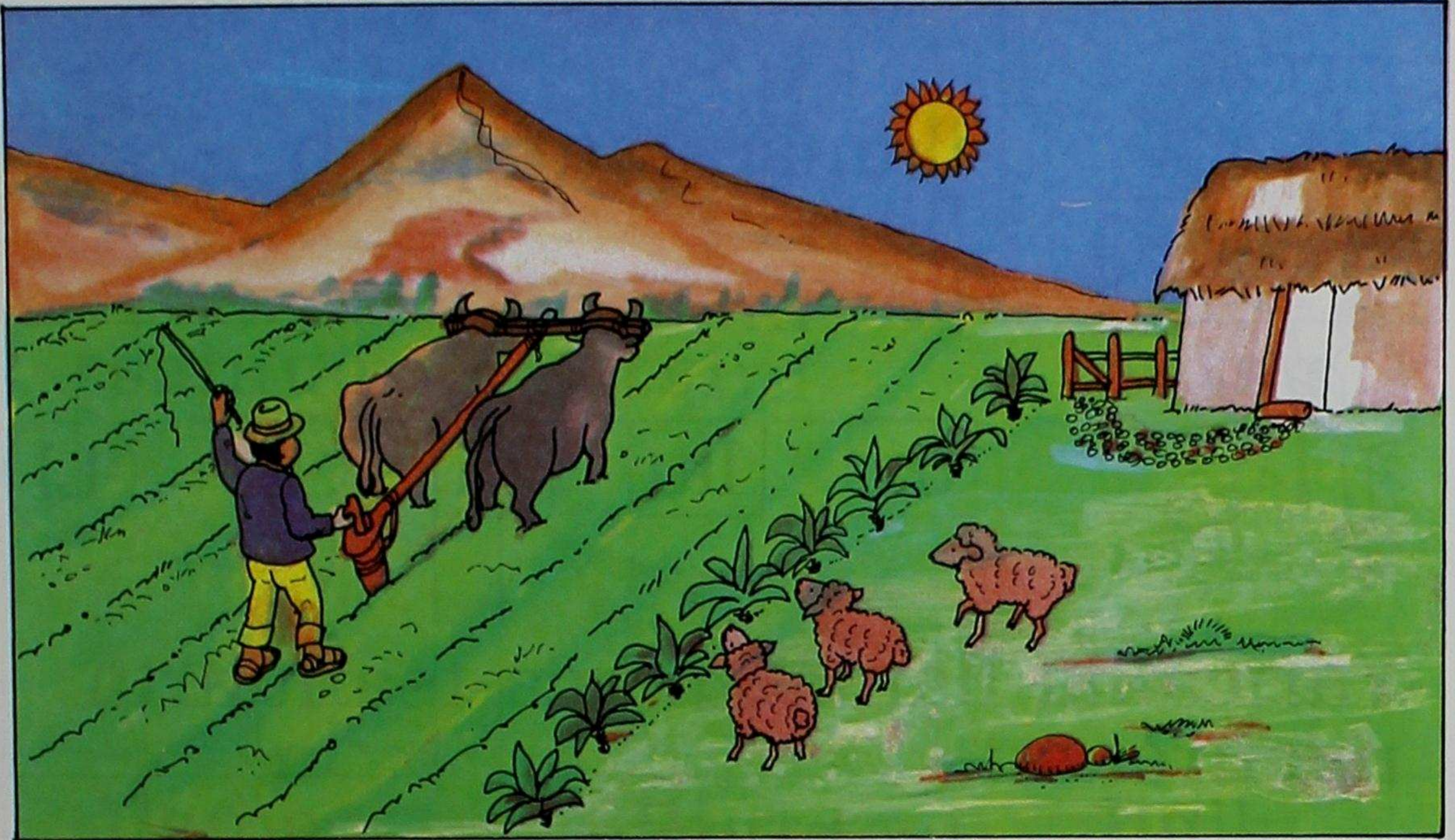

Taitaca tutamanta jatarishpami  
allpata yapuncapac rirca.  
Paica llamacunatapash apashpami  
rirca.

Yaricailla llamacunaca tsahuarta  
micurcami.

Allpata yapucpica cuzucunami  
llucshishca.

Chai punchaca tucuicunami  
yanapanacurca.

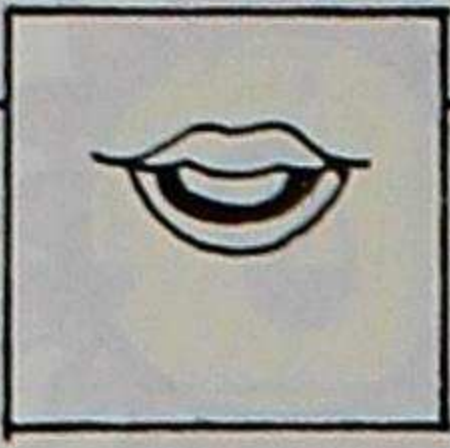

Paica llamacunatapash apashpa  
rirca.



llamacunatapash  
llama  
lla ma

lla

llu

lli

ll = Ll

Yaricailla llamacunaca tsahuarta  
micurcami.

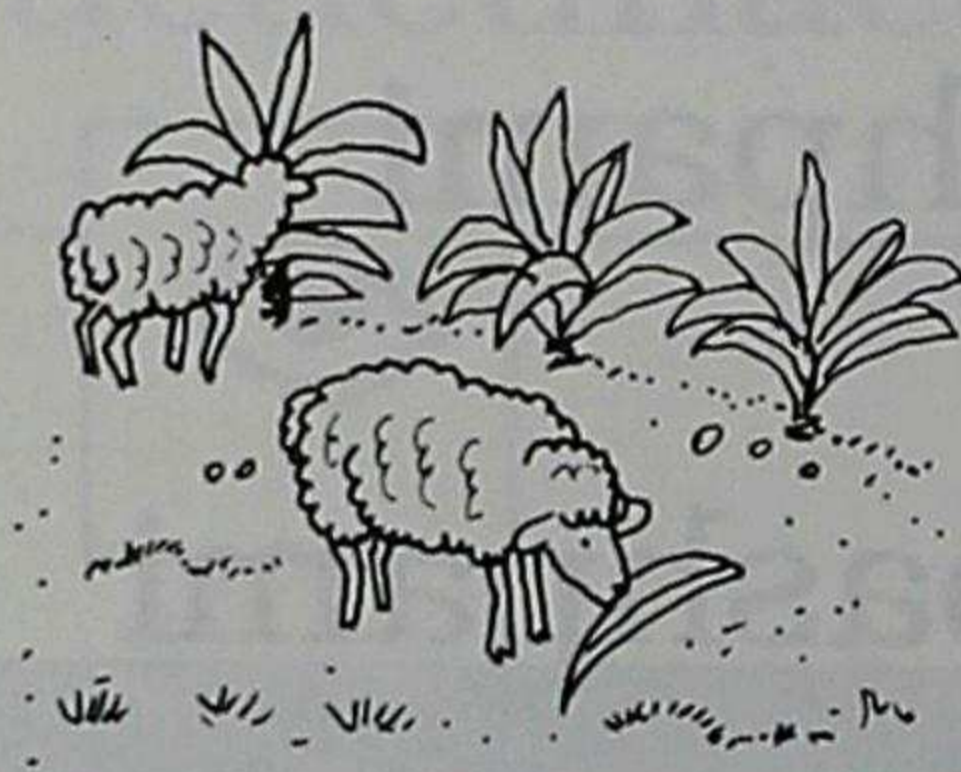

tsahuarta  
tsahuar  
tsa huar

tsa

tsi

tsu

ts = Ts

Allpata yapucpica cuzucunami  
llucshishca.

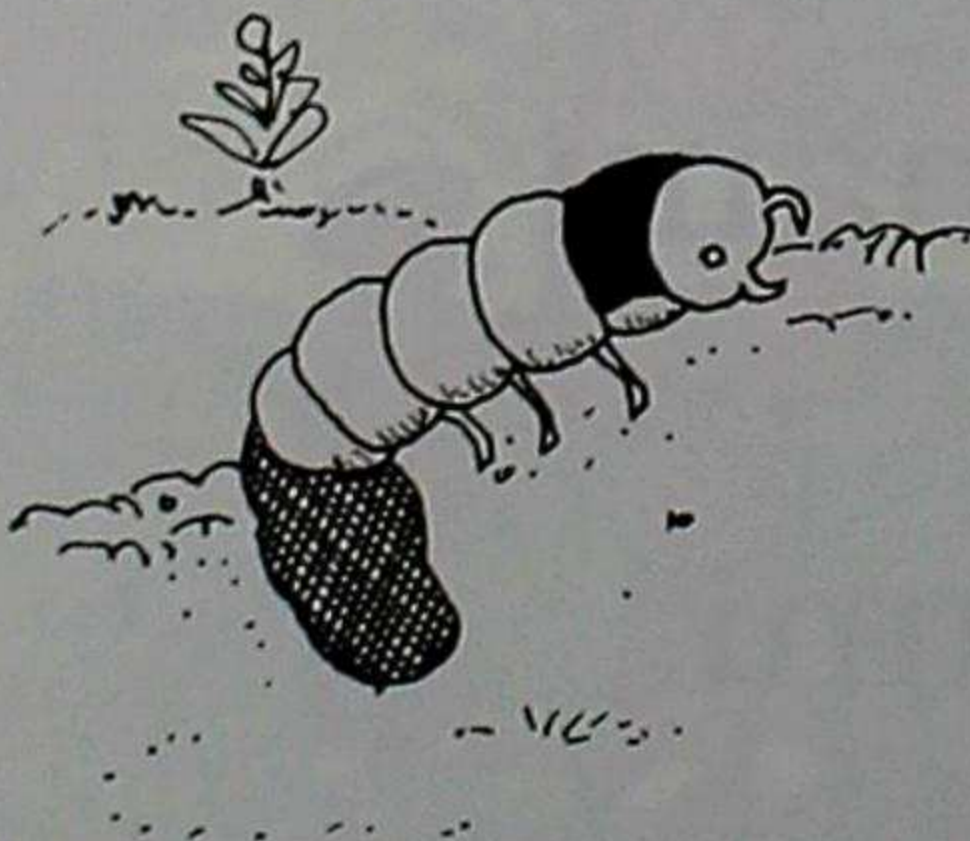

cuzucunami  
cuzu  
cu zu

zu

za

zi

z = Z

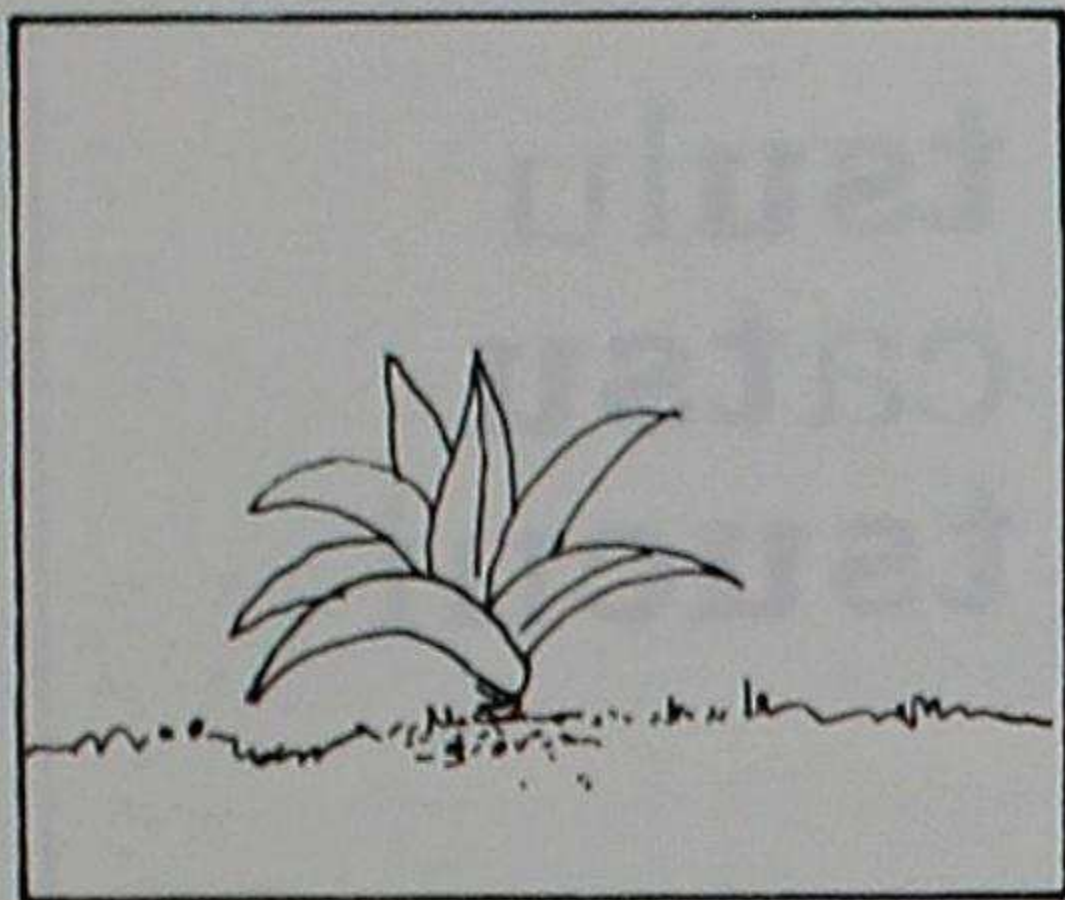
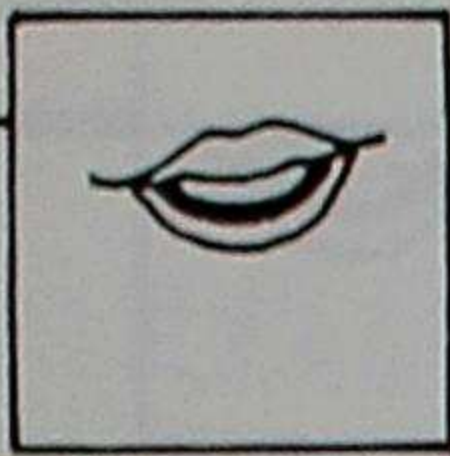

**tsahuar**

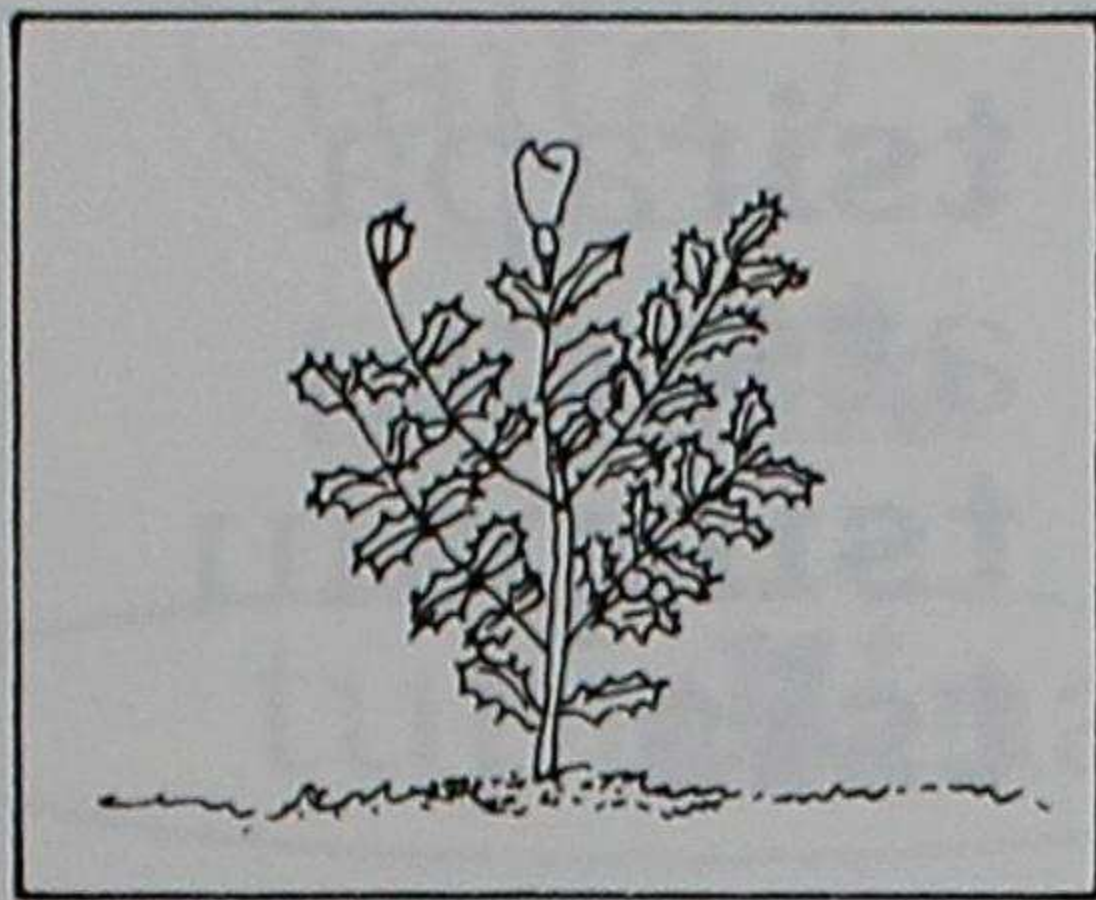

**tsini**

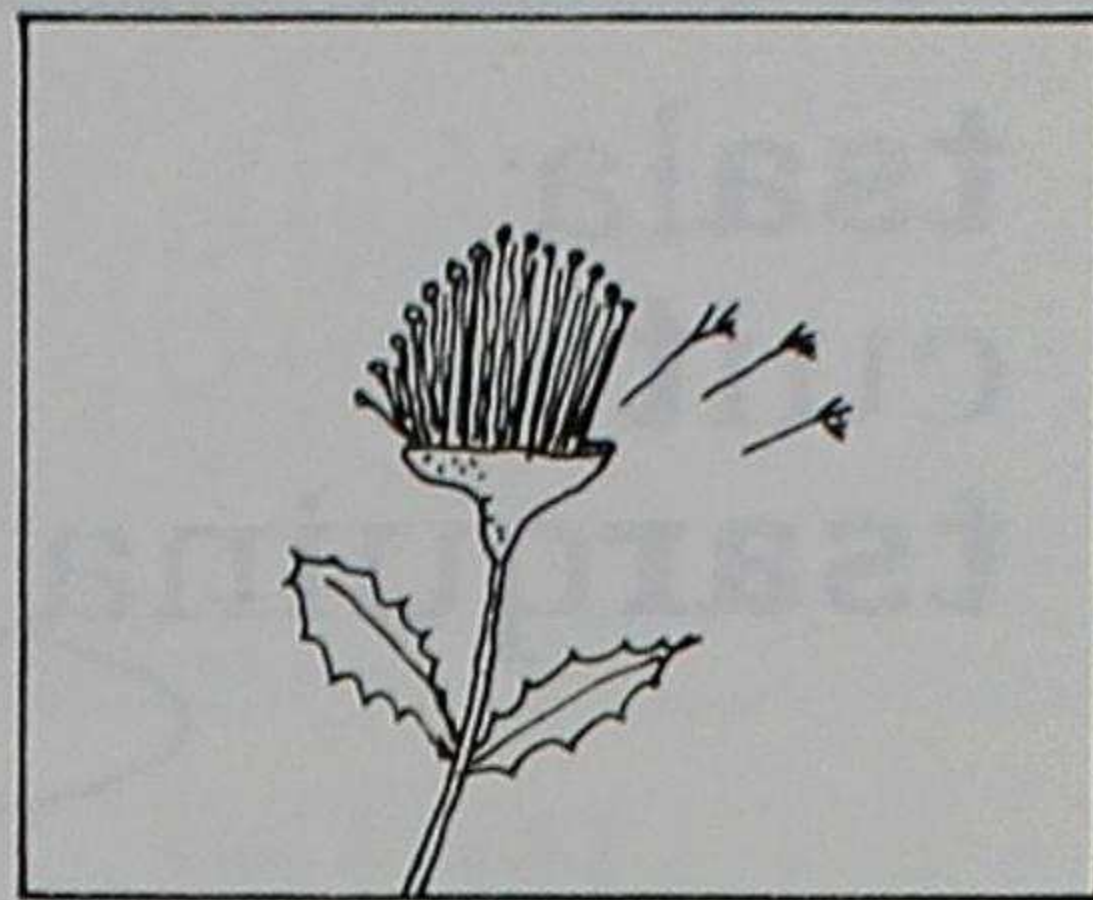

**putsu**

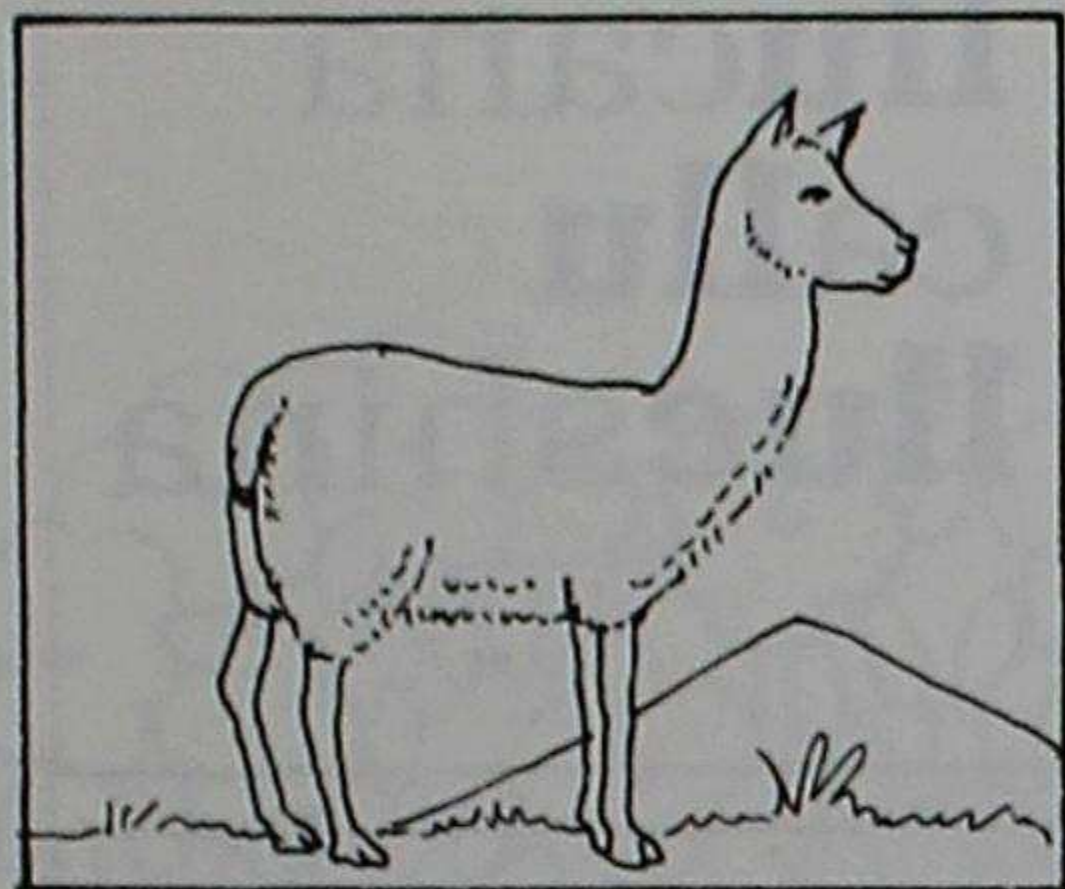

**llama**

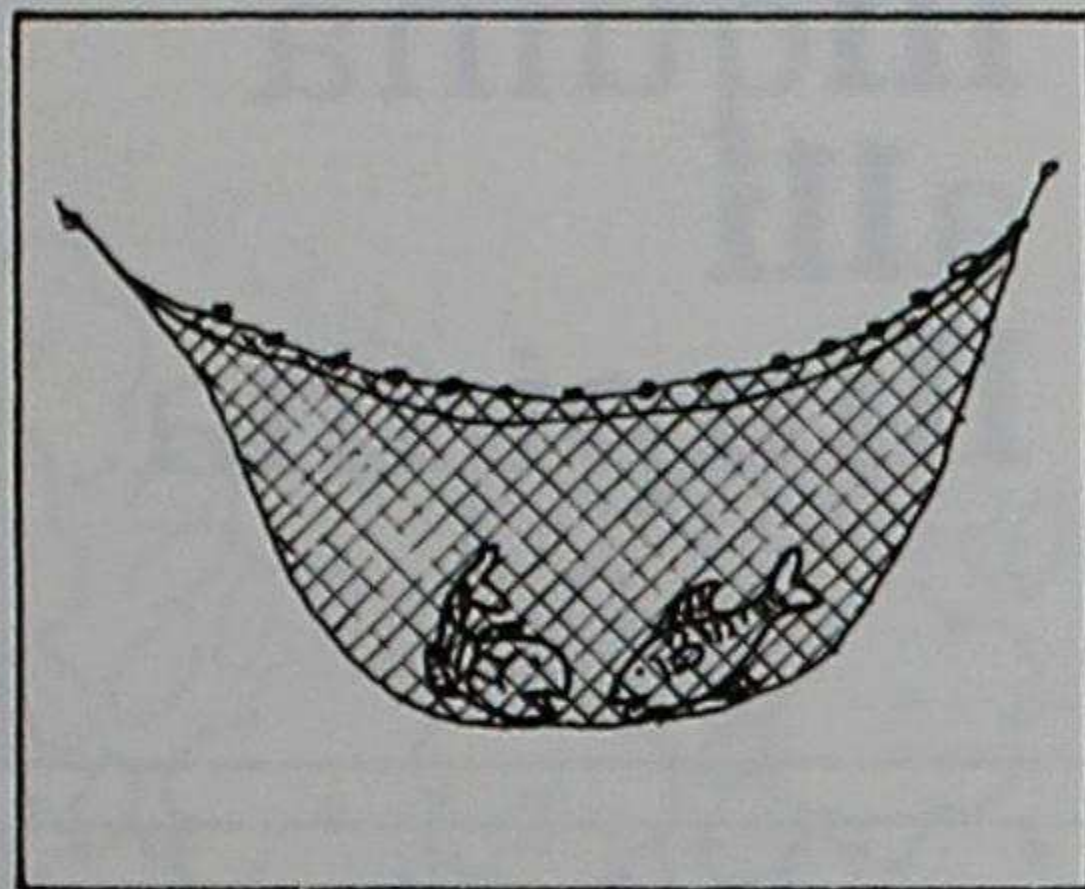

**llica**

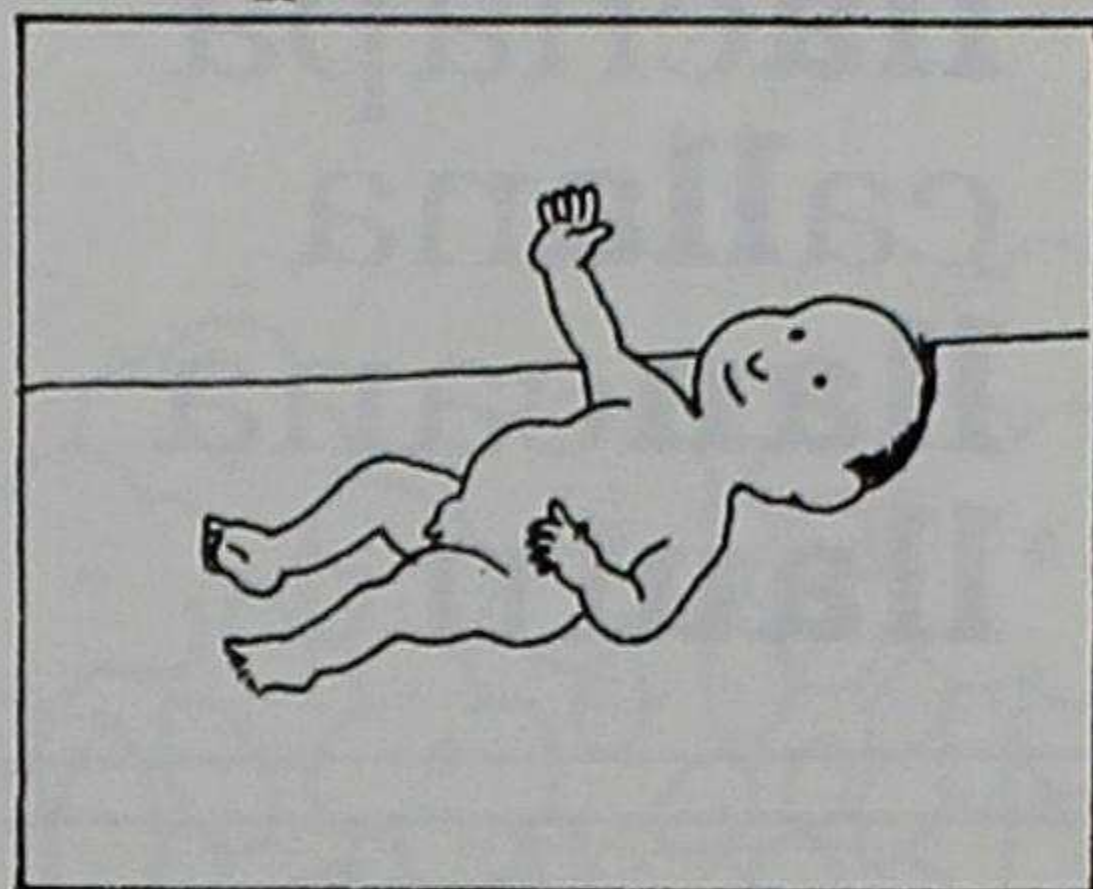

**llulu**

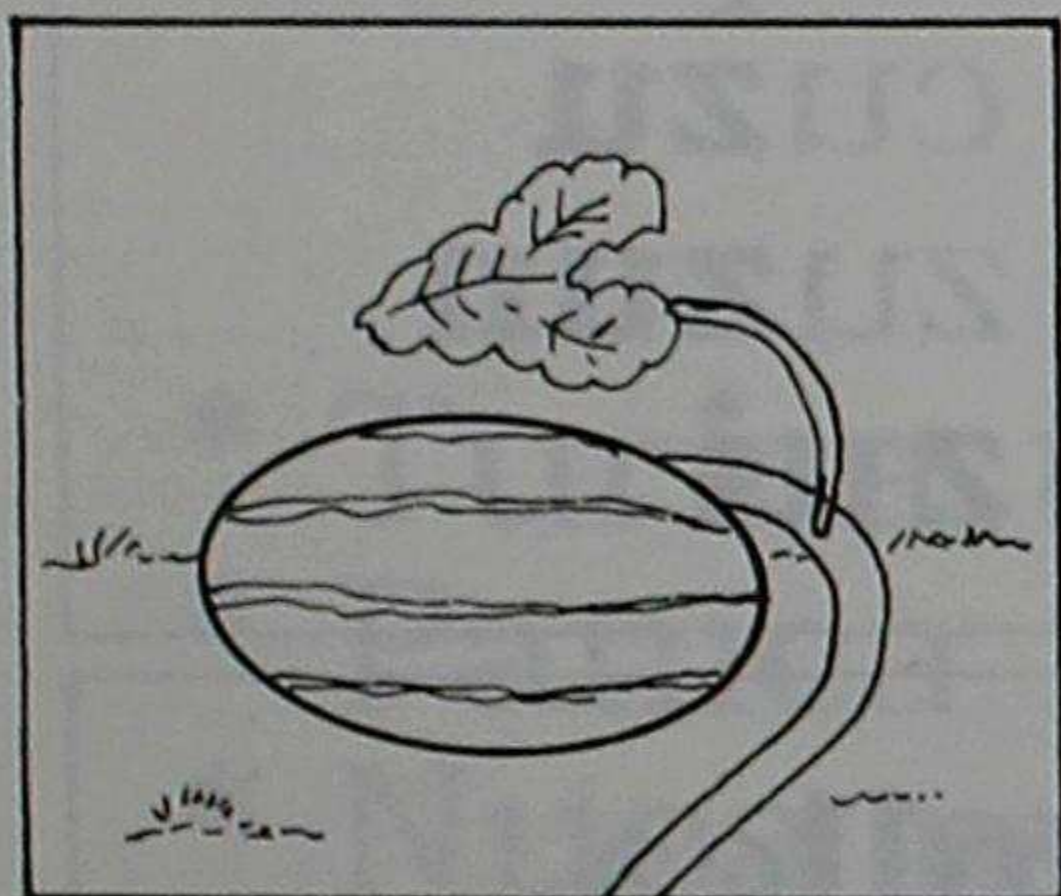

**zanpu**

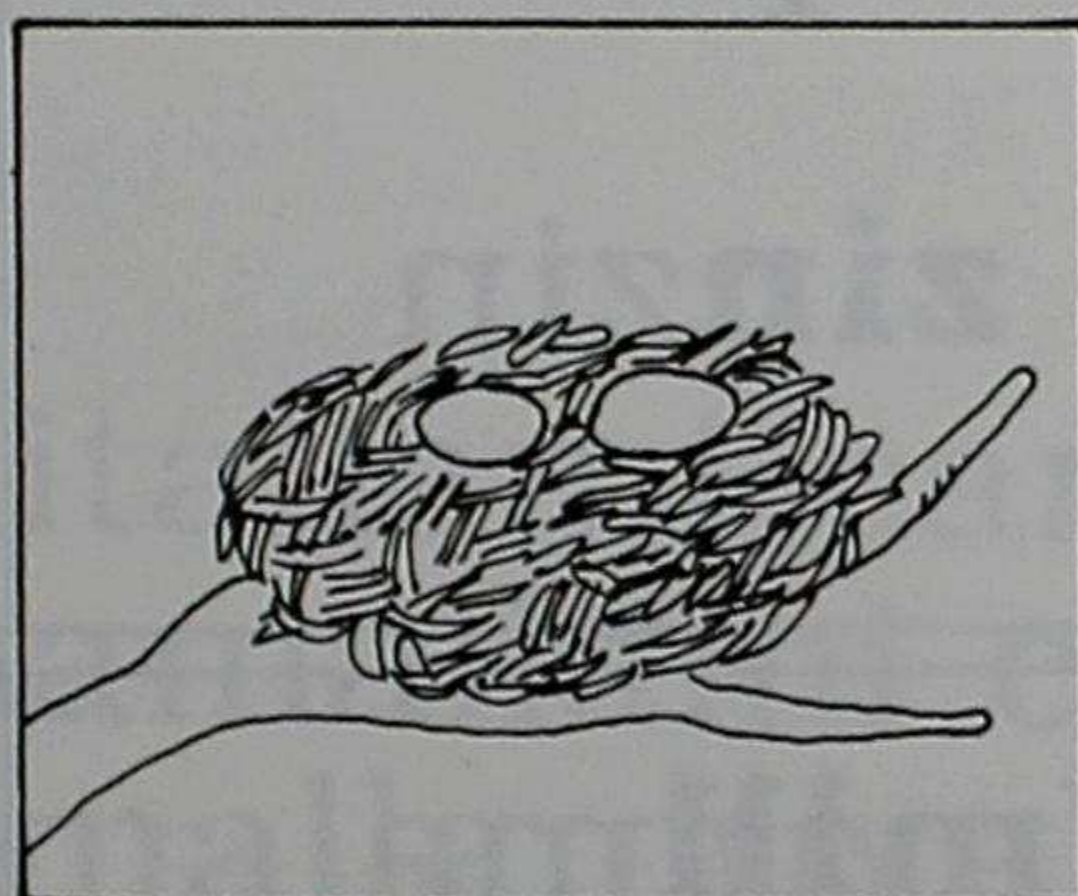

**tazin**

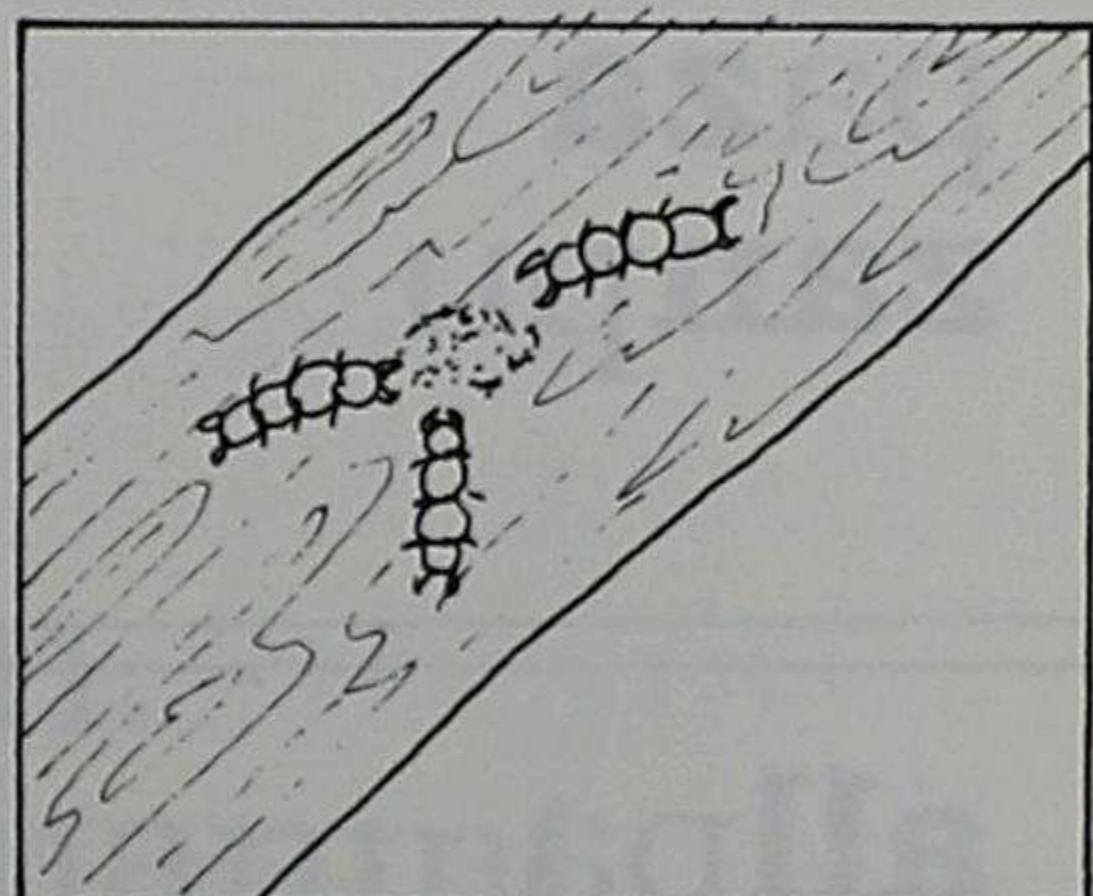

**zuzun**

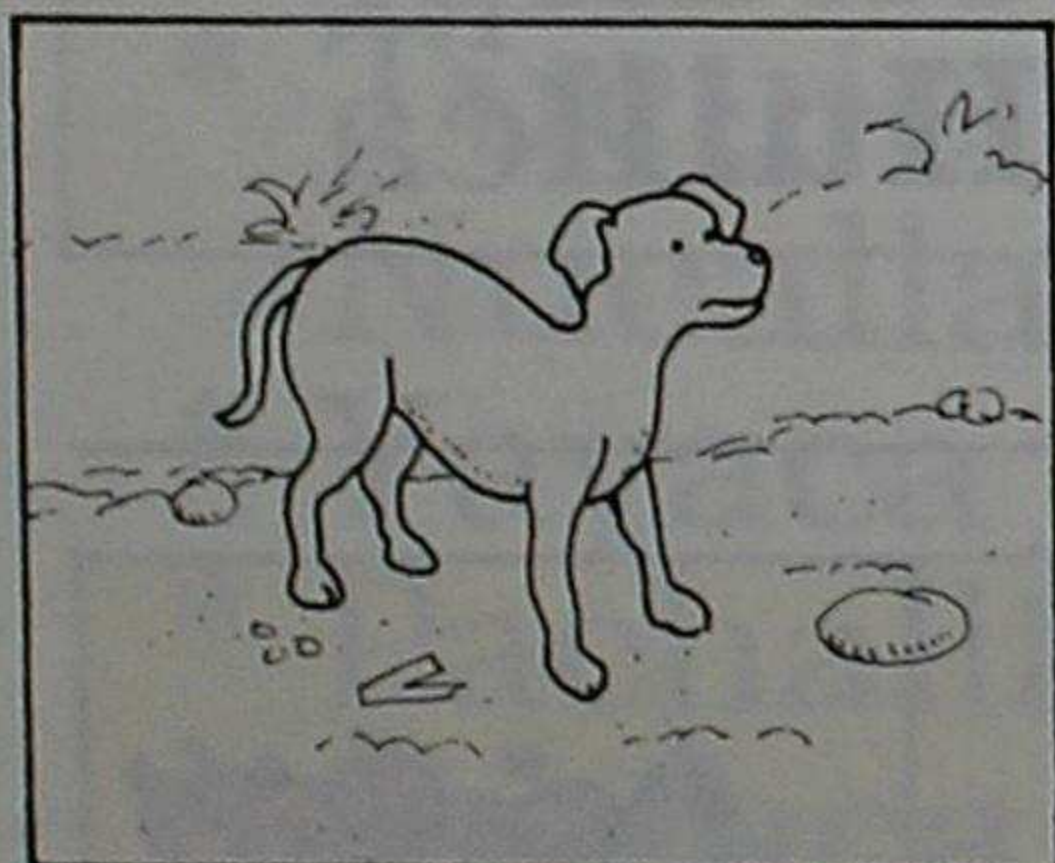

**allcu**

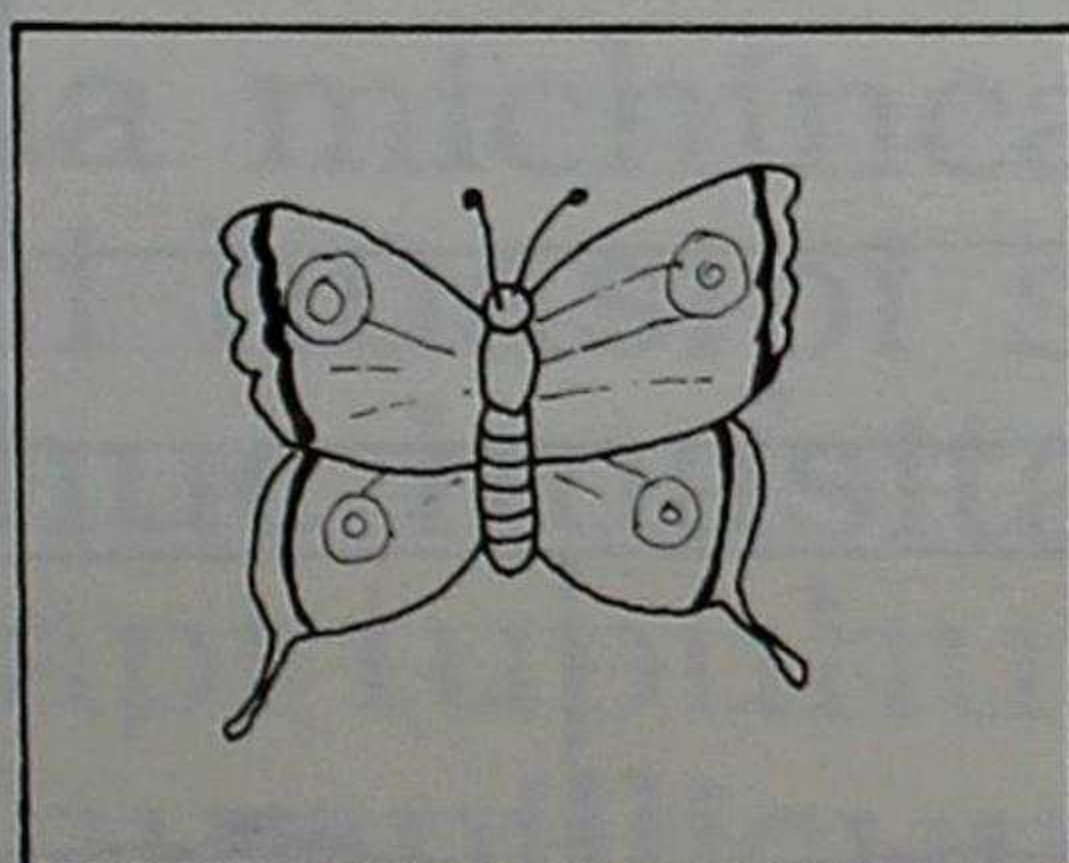

**pillpintu**

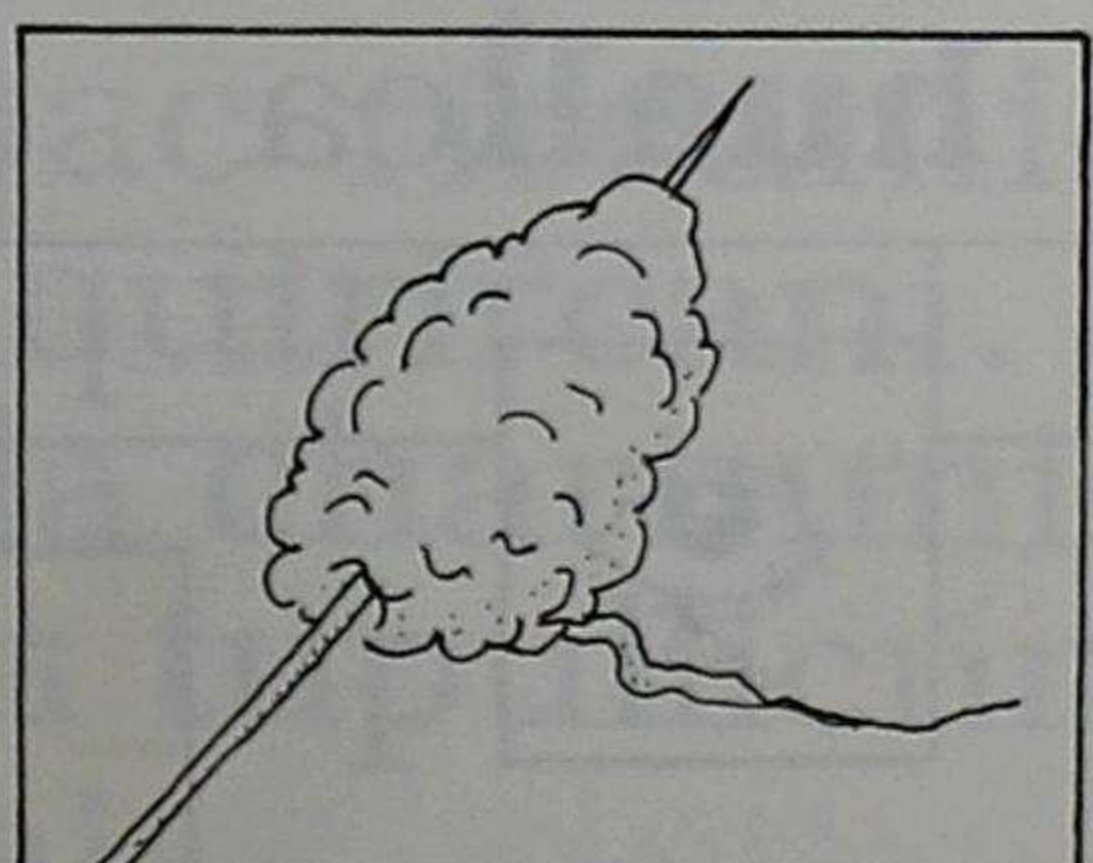

**ullca**

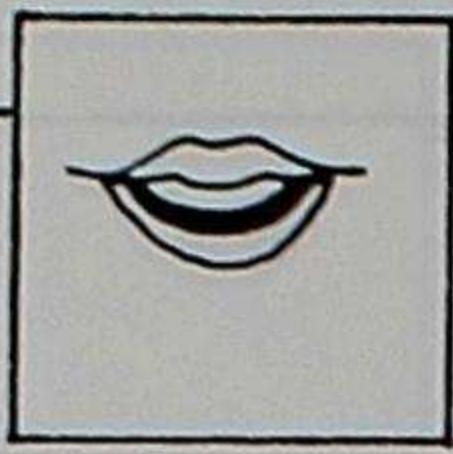

<b>tsala</b> <b>cuitsa</b> <b>tsarquina</b>	<b>tsirapa</b> <b>atsira</b> <b>tsinpalu</b> <b>tsia</b>	<b>tsulu</b> <b>catsu</b> <b>tsucni</b>
<b>llachapa</b> <b>callana</b> <b>llancana</b> <b>llautu</b>	<b>lliquina</b> <b>alli</b> <b>llinpiana</b>	<b>llucana</b> <b>callu</b> <b>llucshina</b>
<b>zacra</b> <b>paza</b> <b>zanpu</b>	<b>zipi</b>  <b>zinzin</b>	<b>zupu</b> <b>cuзу</b> <b>zuzun</b> <b>zui</b>
<b>allpa</b> <b>atallpa</b> <b>huallca</b>	<b>millma</b>	<b>ullca</b> <b>chullpi</b> <b>Huillca</b>

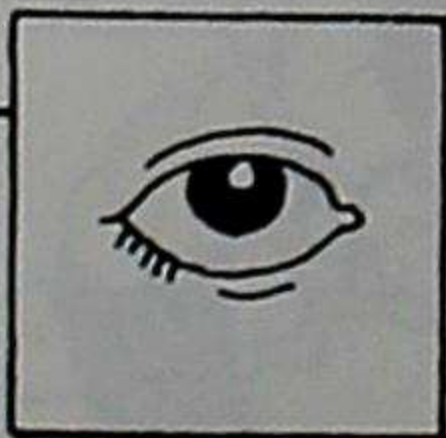

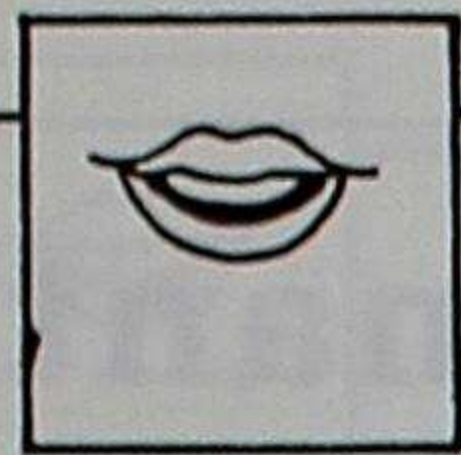

taita

taitalla

tupullina

tupullini

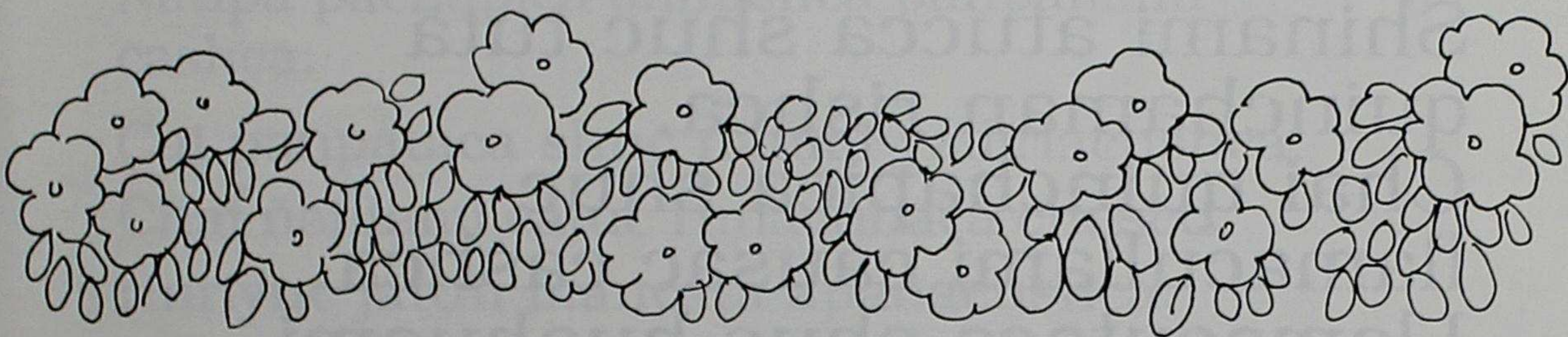

- \* Turica taitallami can.
- \* Panica mamallami can.
- \* Ñuca mamalla cuyahuanmi
- \* Ñuca allculla chincarishcami.
- \* Tucucicuna michincapac rircami.
- \* Ñucallami huasipi saquirircani.
- \* Yayaca shuc huasitalla charinmi.
- \* Pachallinapi tupuhuan tupullicunmi.
- \* Ñañaaca chunpillicunmi.



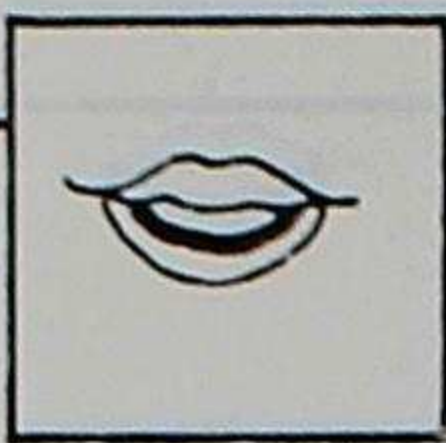

## Llama shua atucmanta

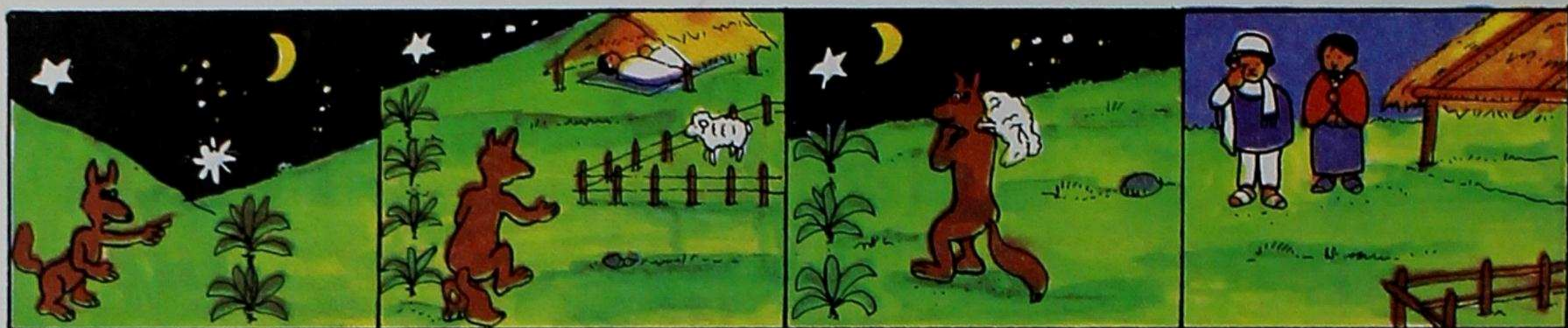

Urcupimi, shuc chupasapa atuc  
llamacunallata micushpa causac  
cashca.

Shinami atucca shuc tuta  
quinchaman rishca.

Chai quinchapica shuc  
llamacullami causac cashca.

Llamacutaca shuc huahuami  
ricuna cashca.

Cai huahuaca ninan puñuisiquimi  
cashca.

Chaicamanca cai atucrucuca  
llamacutaca cuncamanta japishpa,  
ricraman shitashpa paipac causac  
utcuman apashpami micushca.

Huahuaca cayantin llamacu illacta  
ricushpaca, achcatami llaquirishpa  
huacashca.

Chaimanta ninan puñuisiqui  
canaca mana allichu.

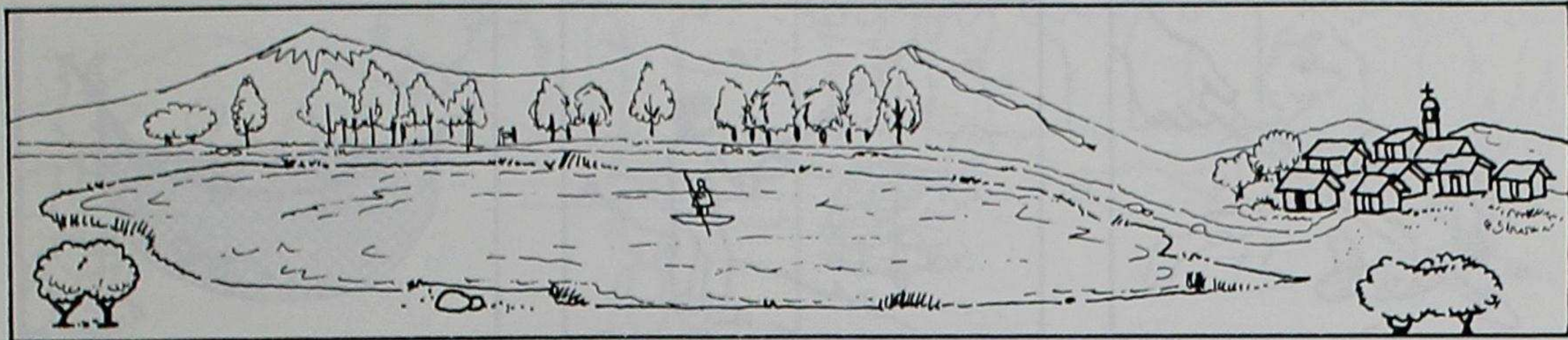
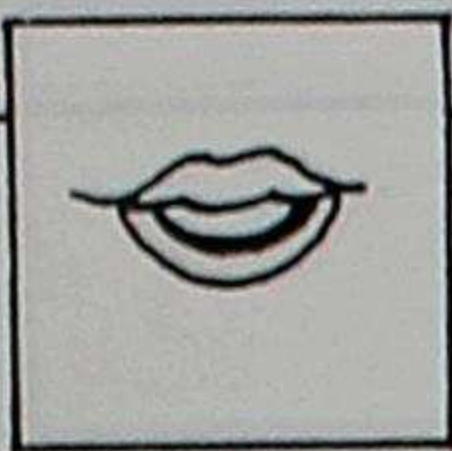

## Culta cuchamanta

Ñaupapachapica shitashca panpallami cashca.

Caipanpataca shuc ñanmi yalliriacushca.

Chai ñantami catuc runacunaca chuscuringriyuc jatun mancata apanacushca.

Runacunaca shaicushpami caipanpapi samancapac tiyarishca.

Samanacucpica tamiashpami mancapi yacujuntai callarishca.

Caiyacuta jichaitaca mana ushashcacunachu.

Chaimanta mancharishpa Liripanpa cushipatacunaman huillancapac rishca.

Runacuna cushipatacunantin ticranuncacamanca ñamichuchatucushca cashcainin.

Chai cuchapica achca cultacunami causai callarishca. Chaimantami Culta cuchata shutichishca.

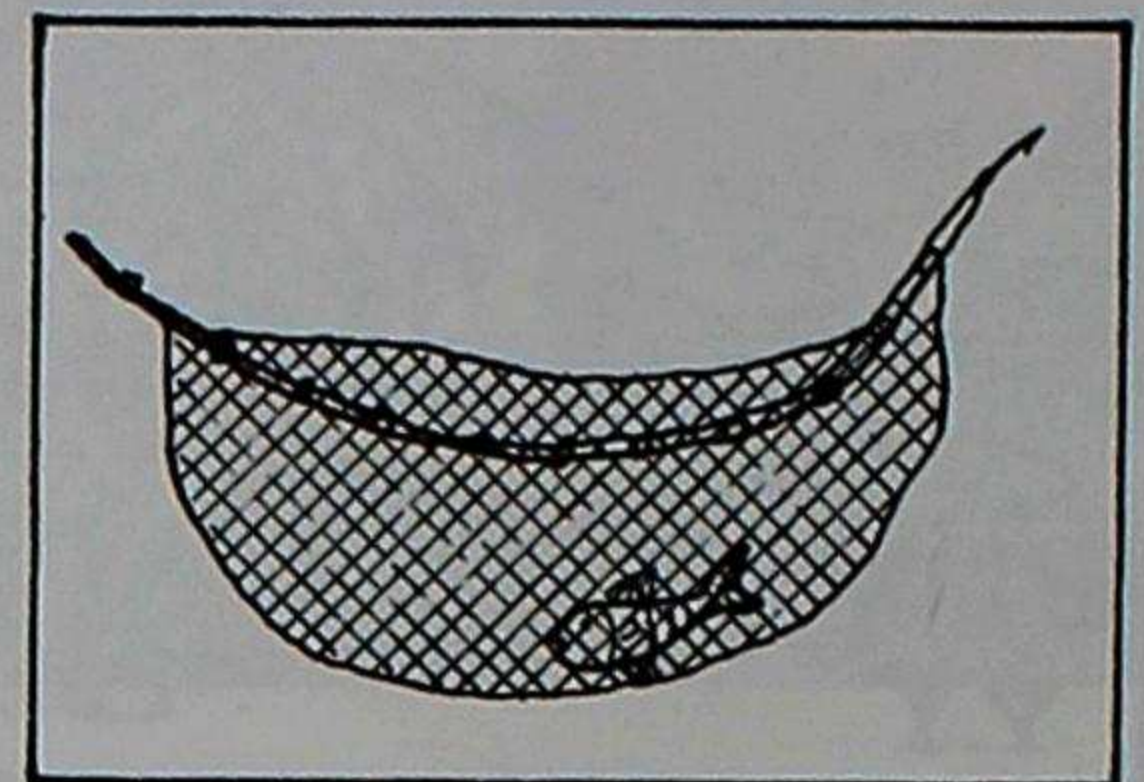
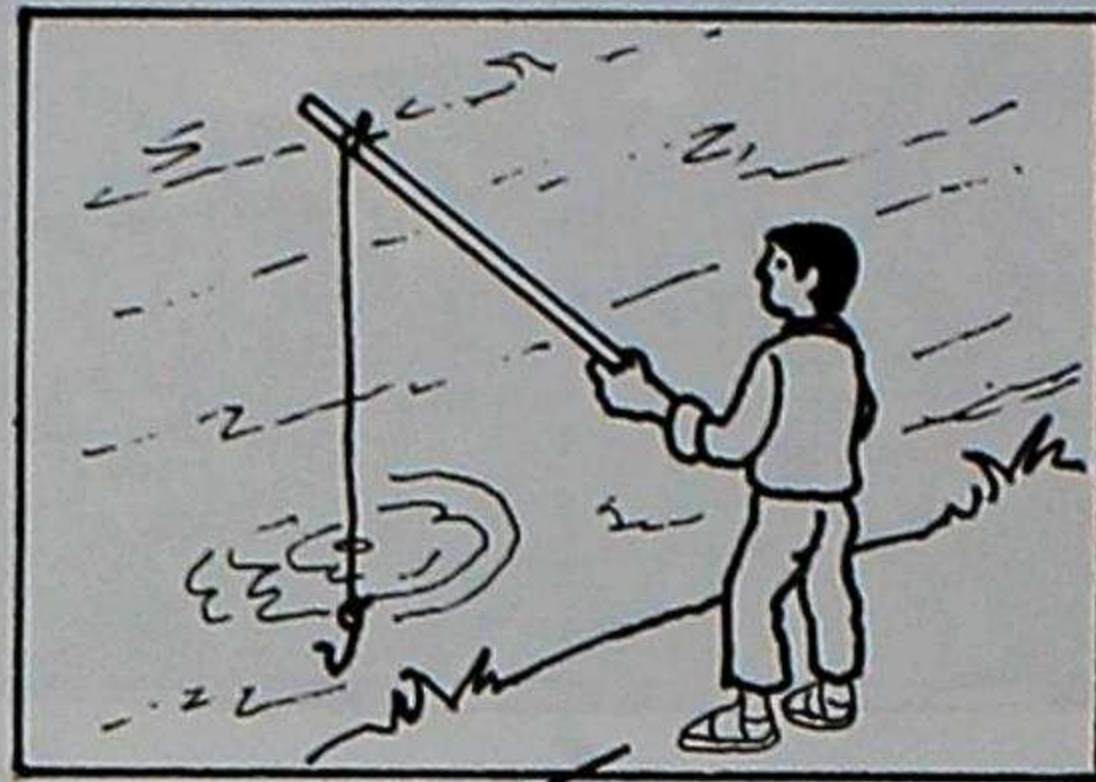
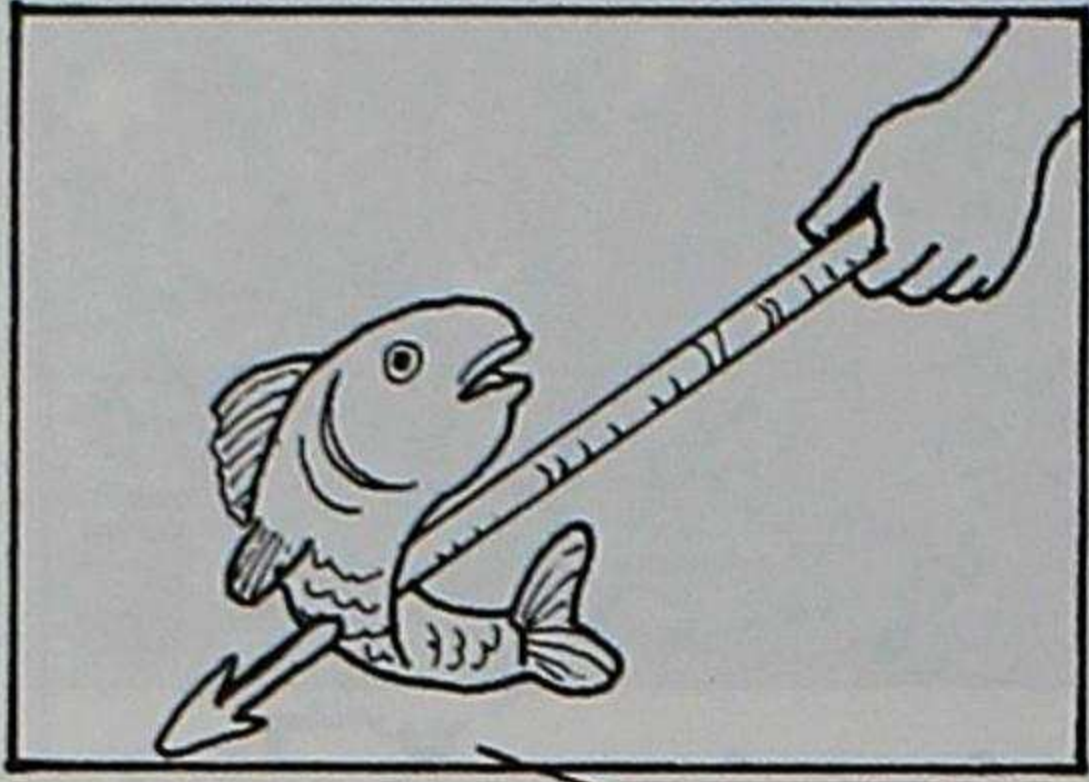
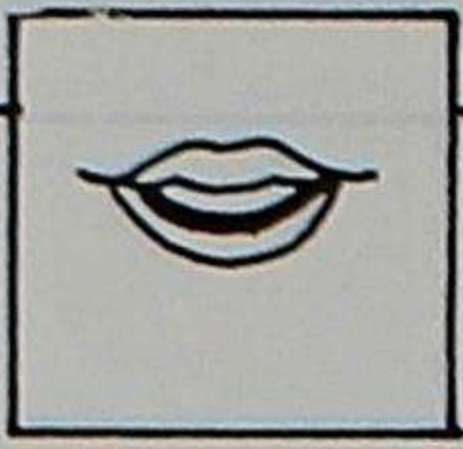

huachi

lica

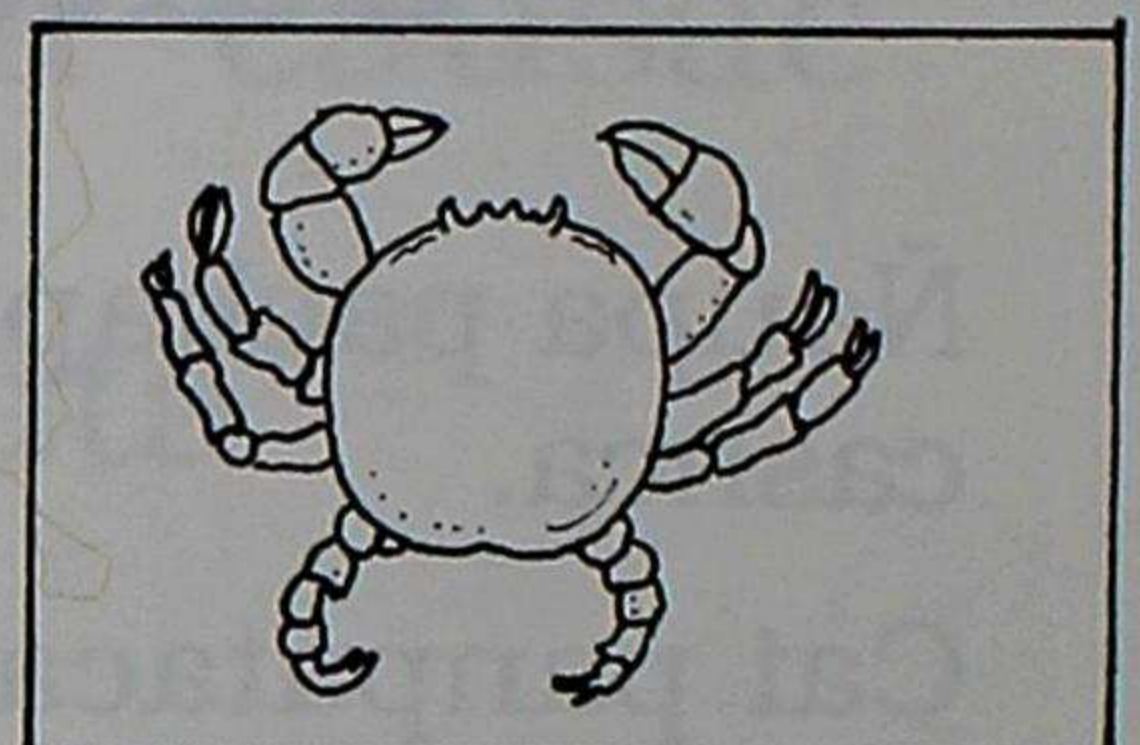
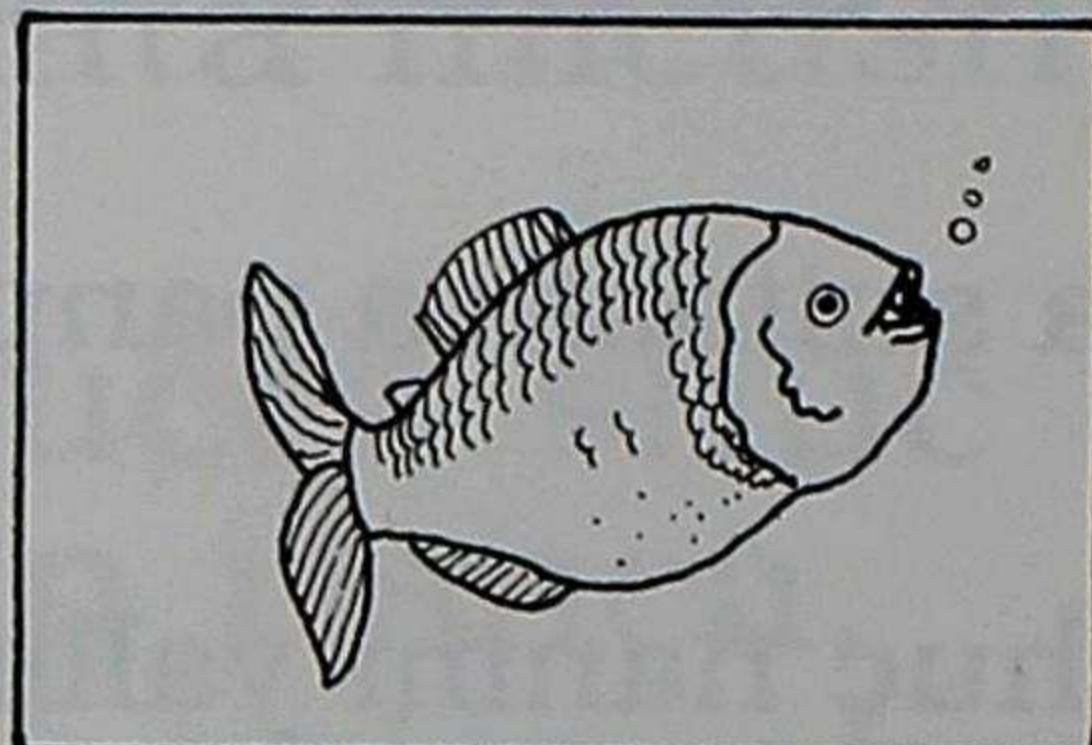
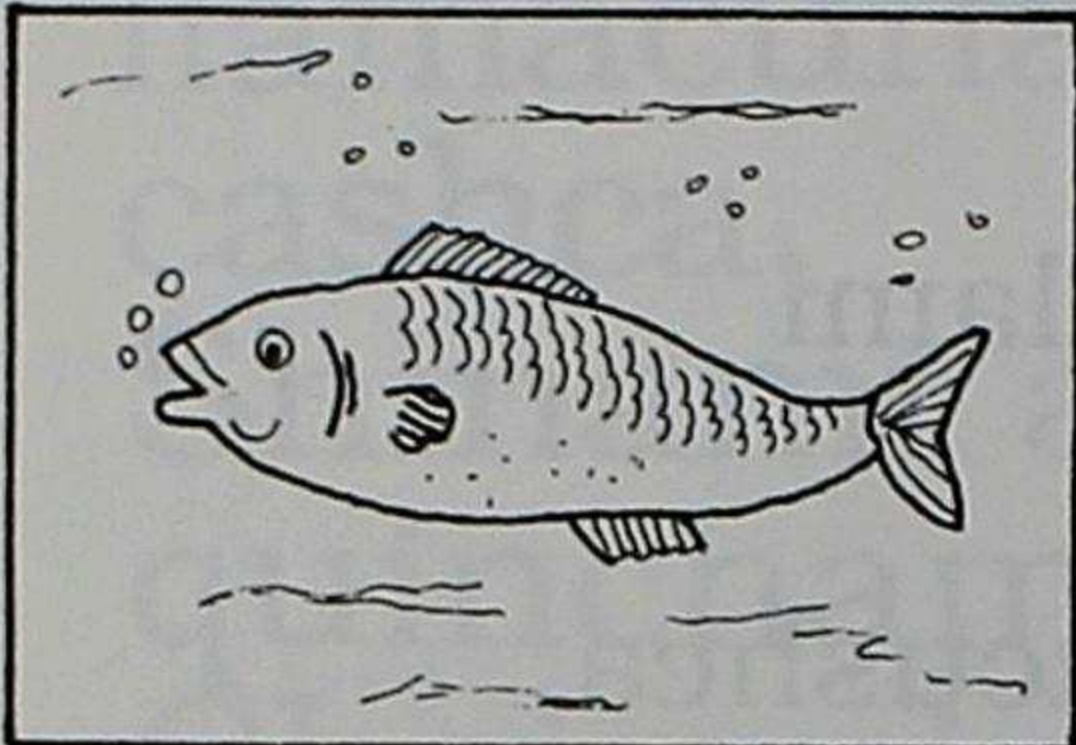

challhua

pañã

apancura

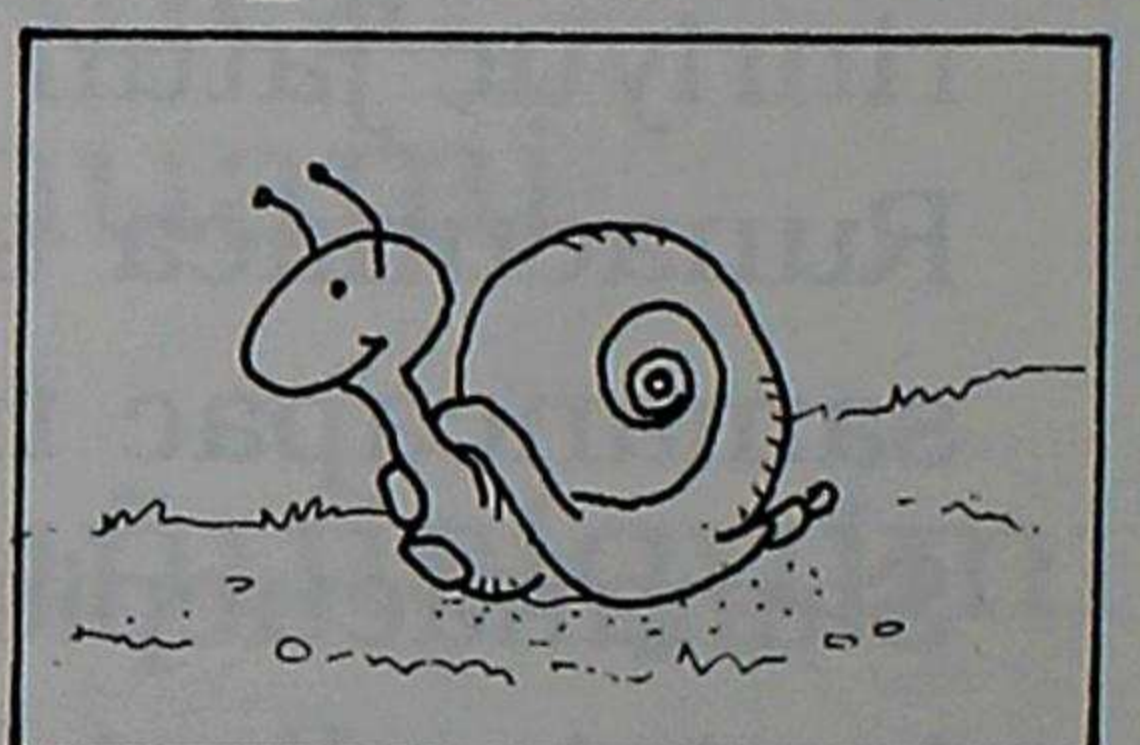
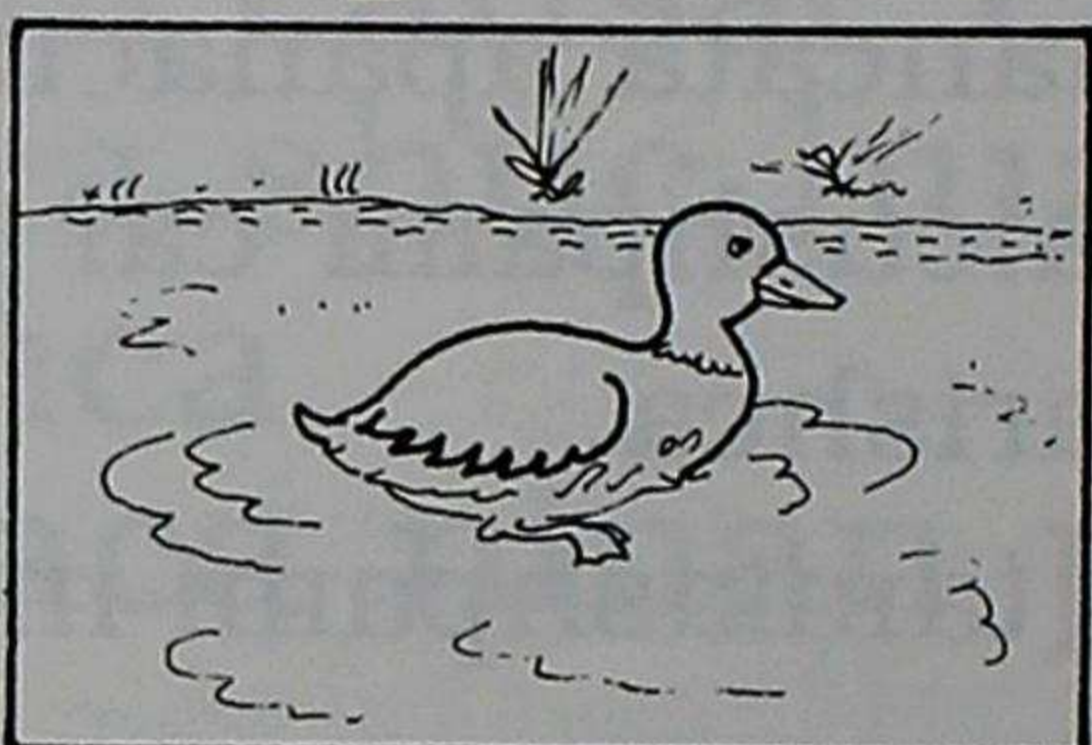
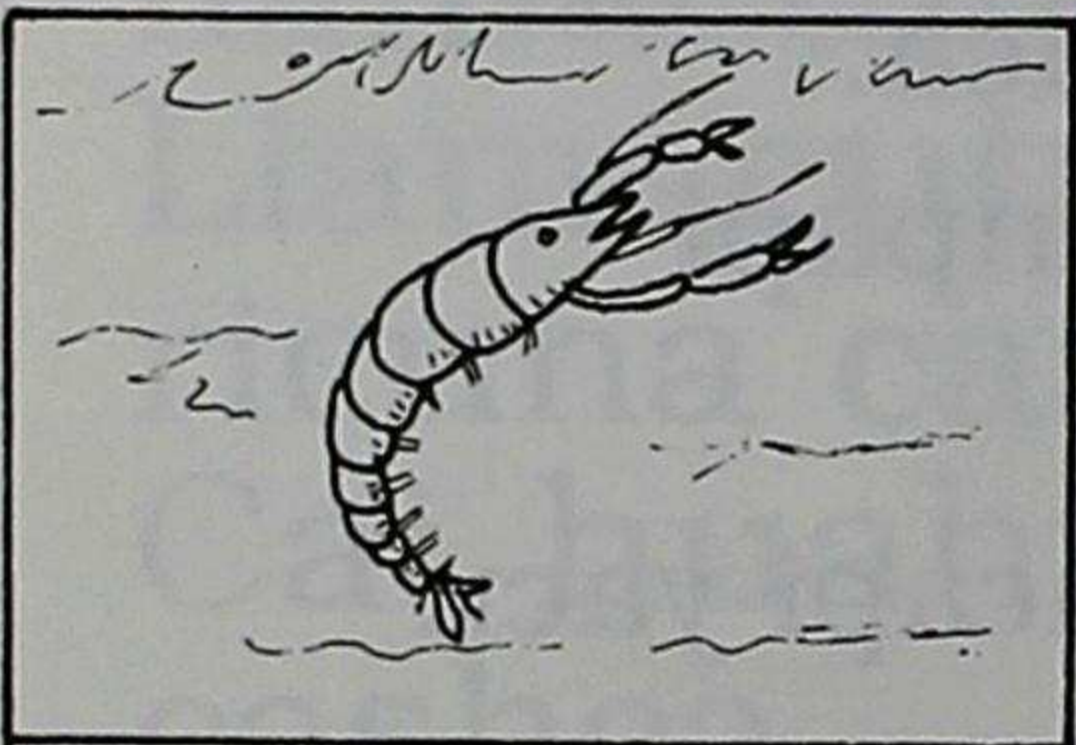

lluchunca

culta

churu

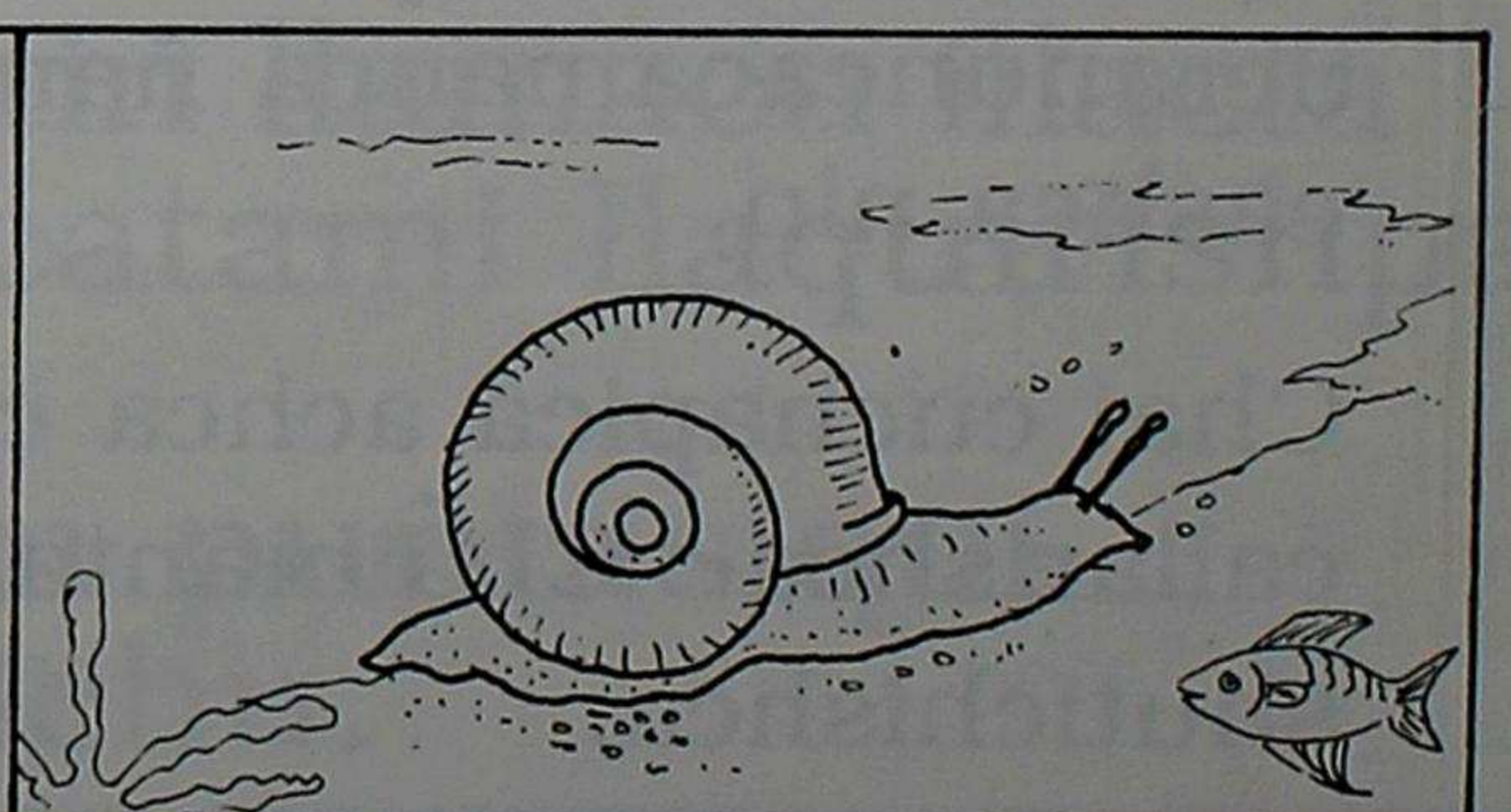
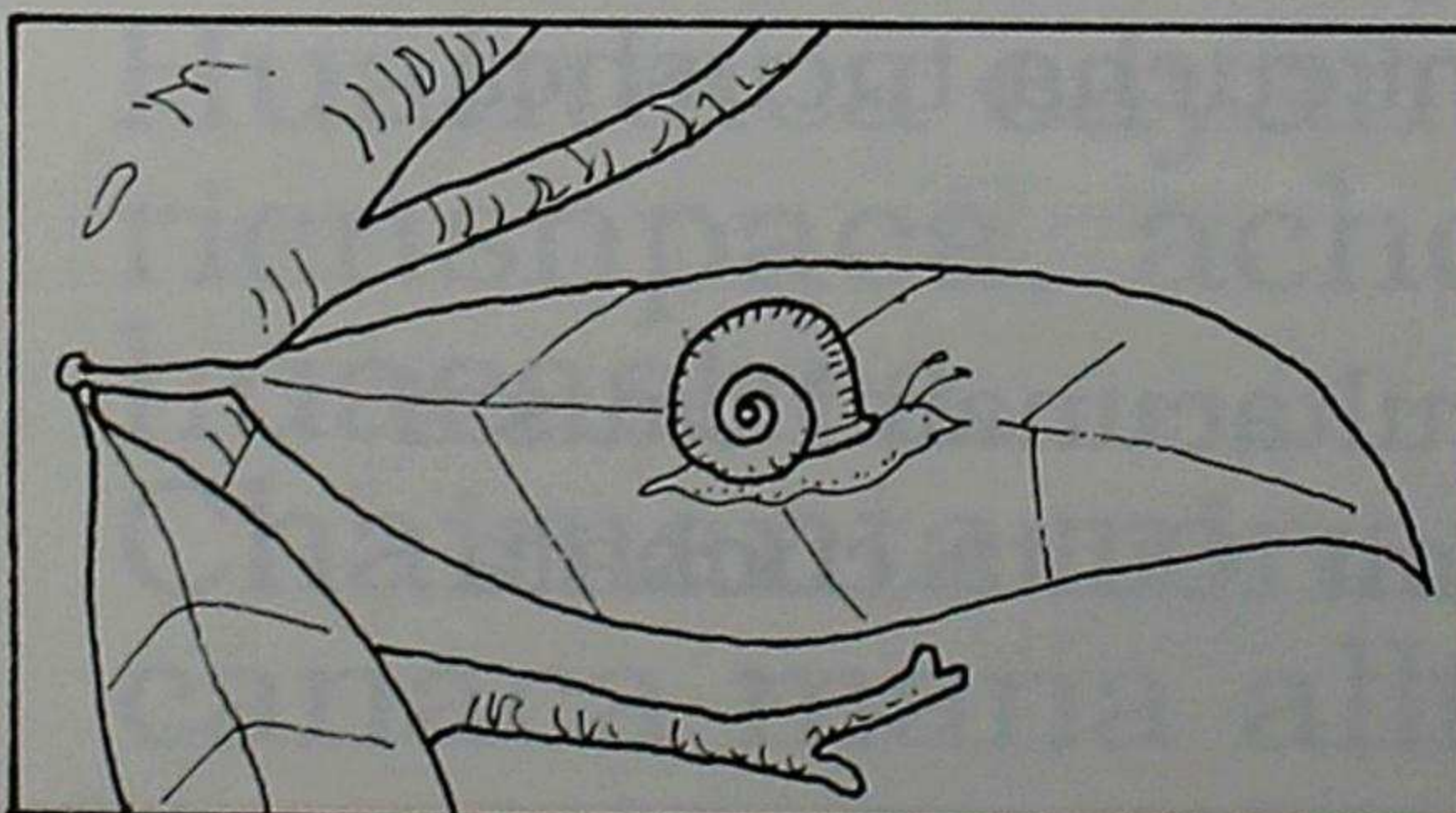
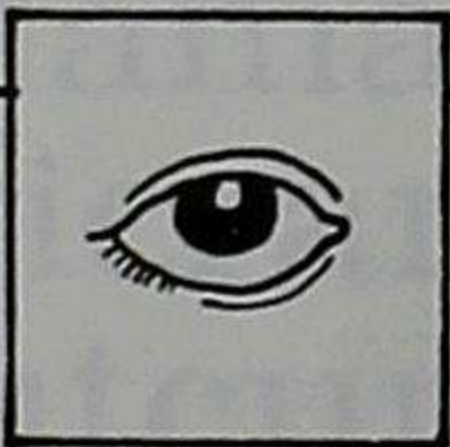

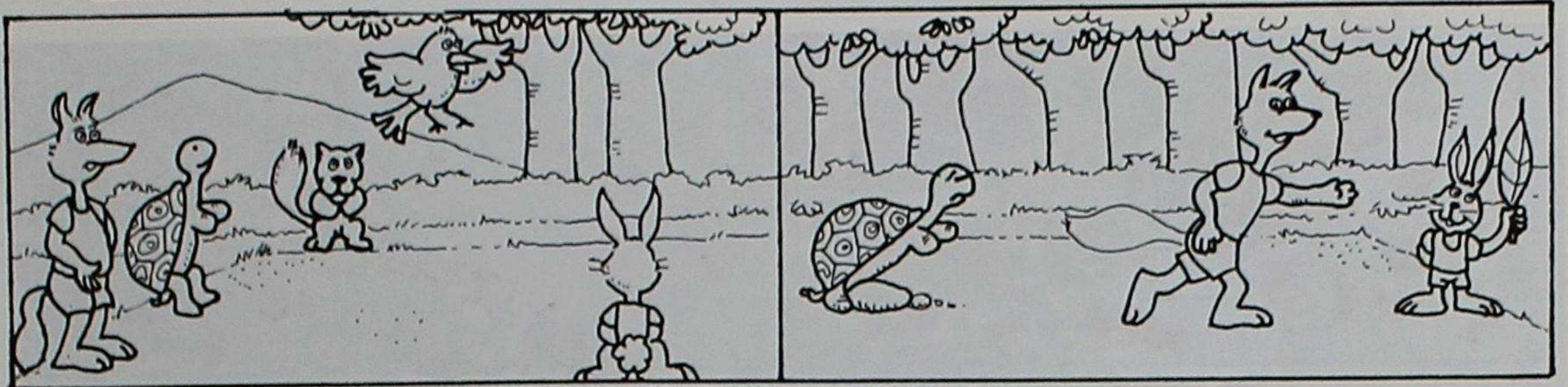
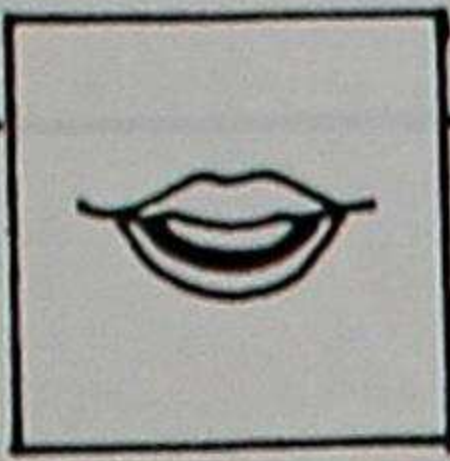

## Callpaimanta

Shuc yahuatimi shuctac huihuacunamanca nin:

- Cai chupasapa allcurucutaca ñucami callpancapacca yallini nishpaca purishca.

Chaita uyashpami allcuca nin:

- Callpashpa ricushun nishca.

Chashnami shuc punchaca tucui huihuacuna cai jatun callpaita ricuncapac tantanacushca.

Yahuatica allillami callpashca, cutin allcuca ucta, uctalla callpashpami yahuatitaca mishashca.

Yahuatica pincaihuanmi llucshishpa rishca.

Chaimantami imatapash mana ushashpaca, mana chaitaca ushanimi ninallachu canchic.

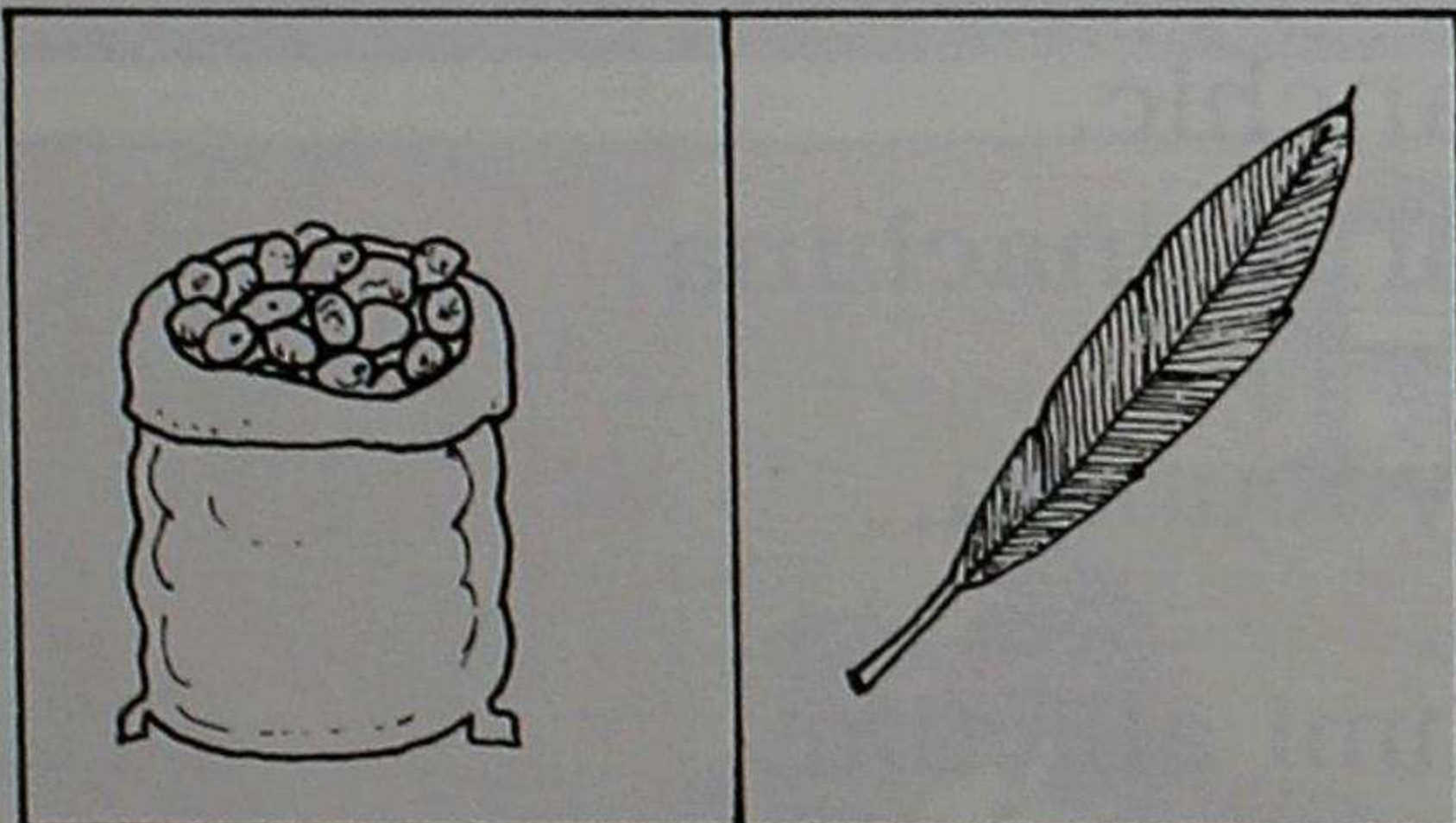

llashac pancalla

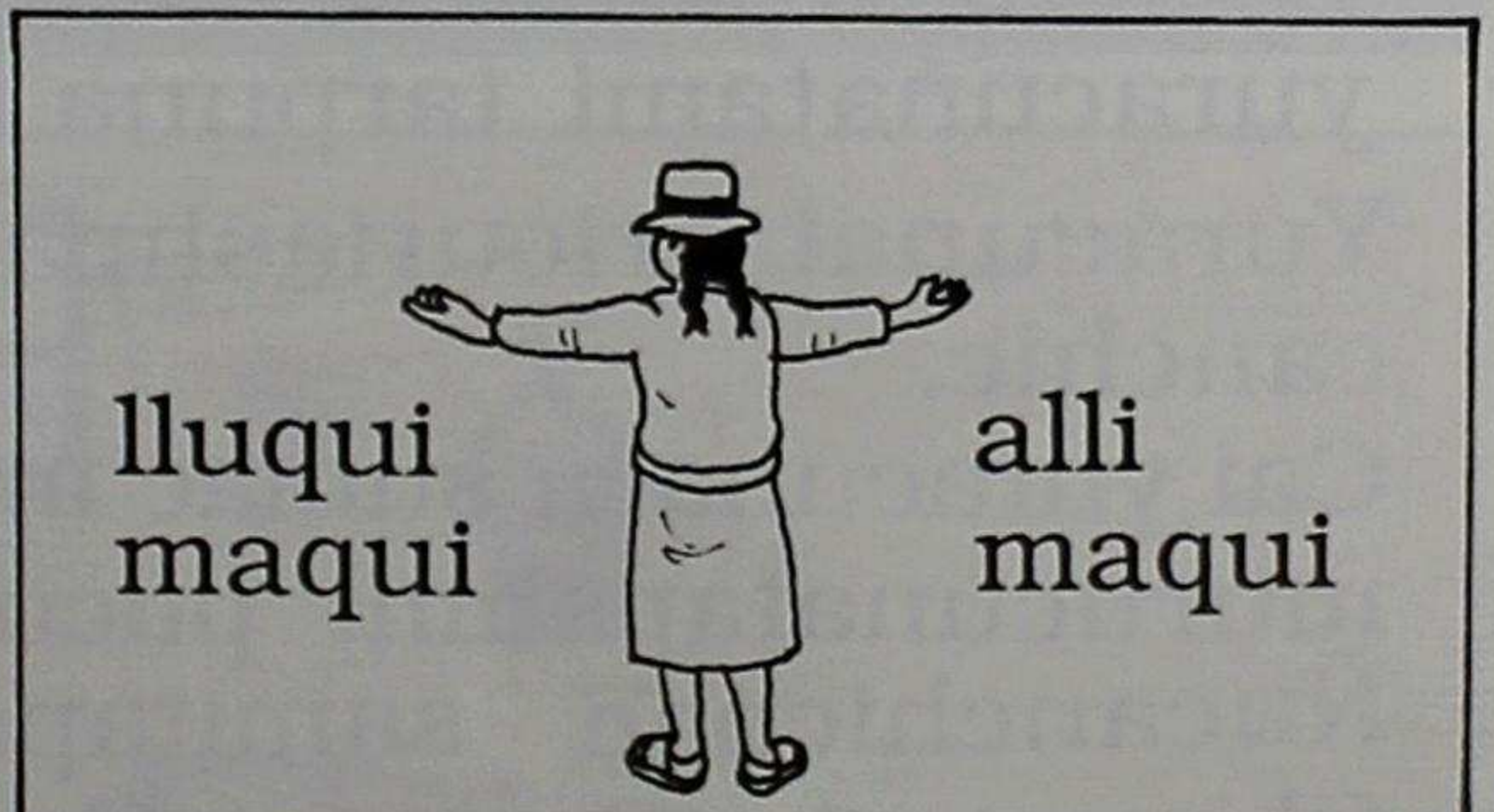

lluqui  
maqui

alli  
maqui

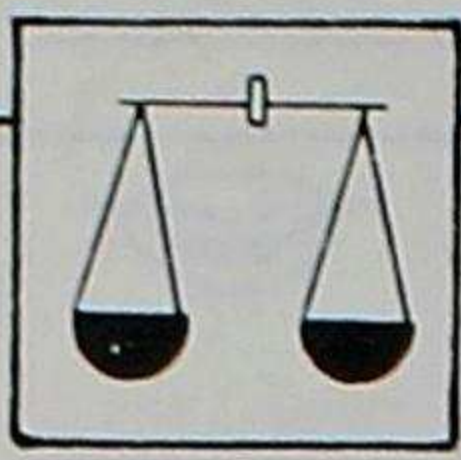

## Huallichicmanta



Cunan pachapica runacunaca tucui yuracunatami cuchushpa shitancuna.

Chaipi tiyac pishcucuna, curuna, tucui huihuacunatapashmi huañuchincuna.

Shina cai sumac allpacunaca huacllirishpca catincuna.

Chaimanta cai allpacuna ama huacllirichunca tucucuna tantanacushpa yanapana canchic.

## Sumac yuracunata tarpunamanta



Jatun yuracunata cuchushpaca shuc mushuc yuracunatami tarpuna canchic.

Yuracunata ricuriashpami huiñachina canchic.

Cai yuracunaca sumac muyucunata, murucunatapashmi pucun.

Nucanchicpac samitapashmi allichin.

Chasnami cai sumac causaipachataca allichishpa catina canchic.

# Churanamanta

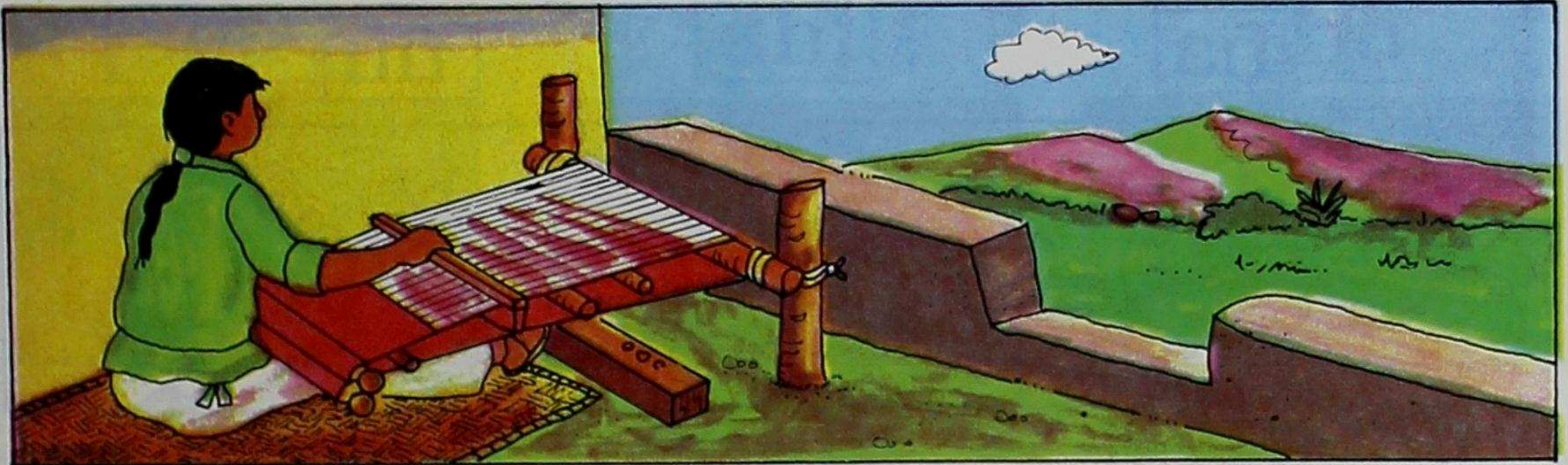



hua

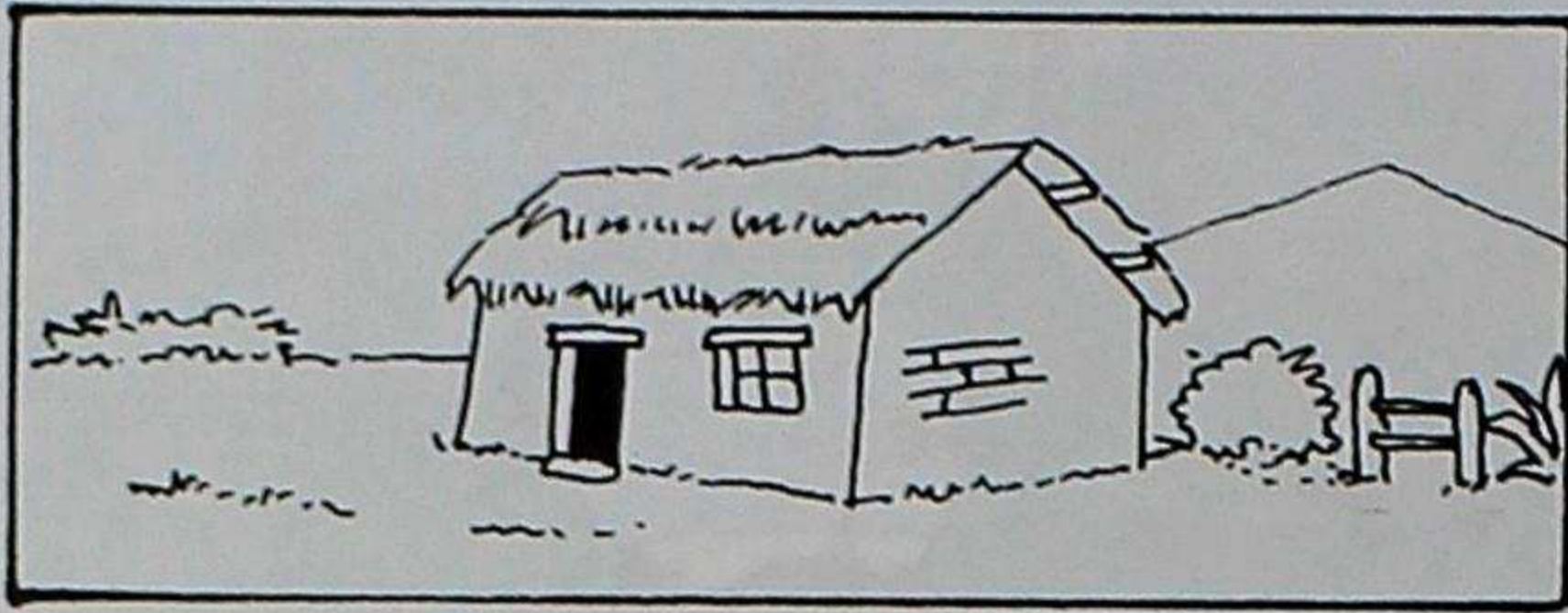

**huasi**

hui

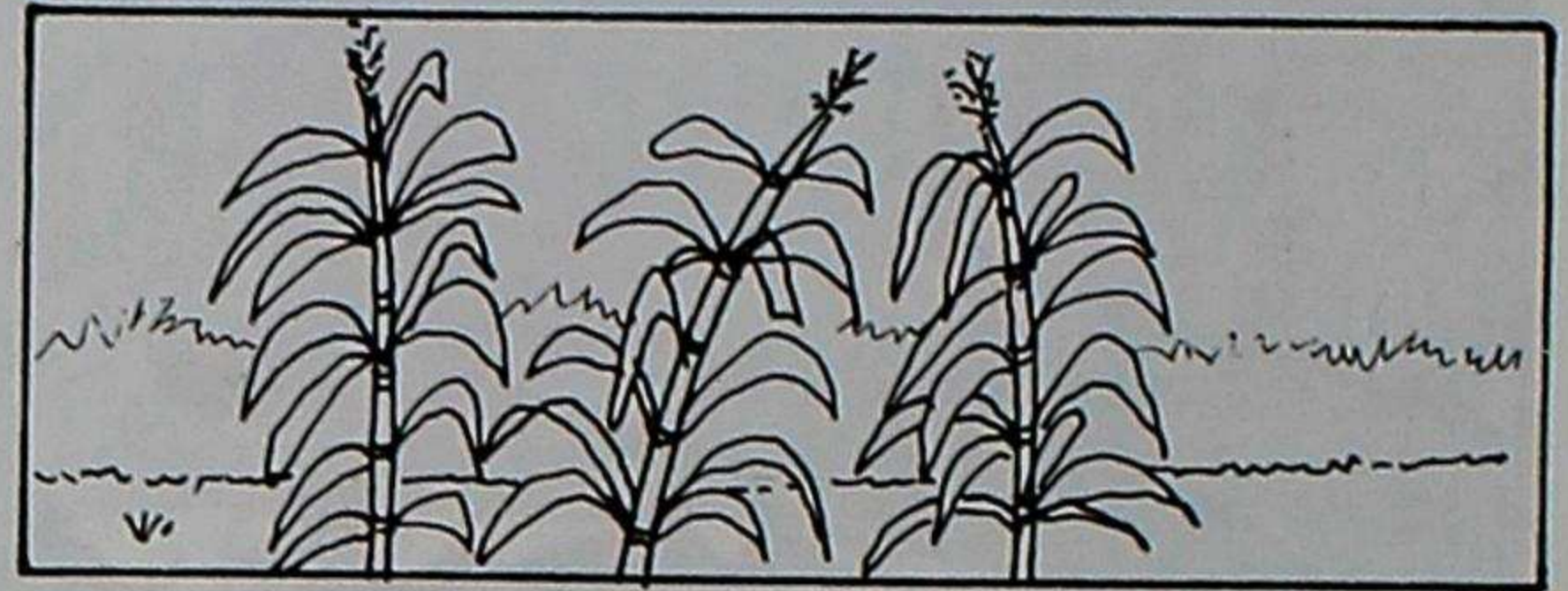

**huiru**

huai

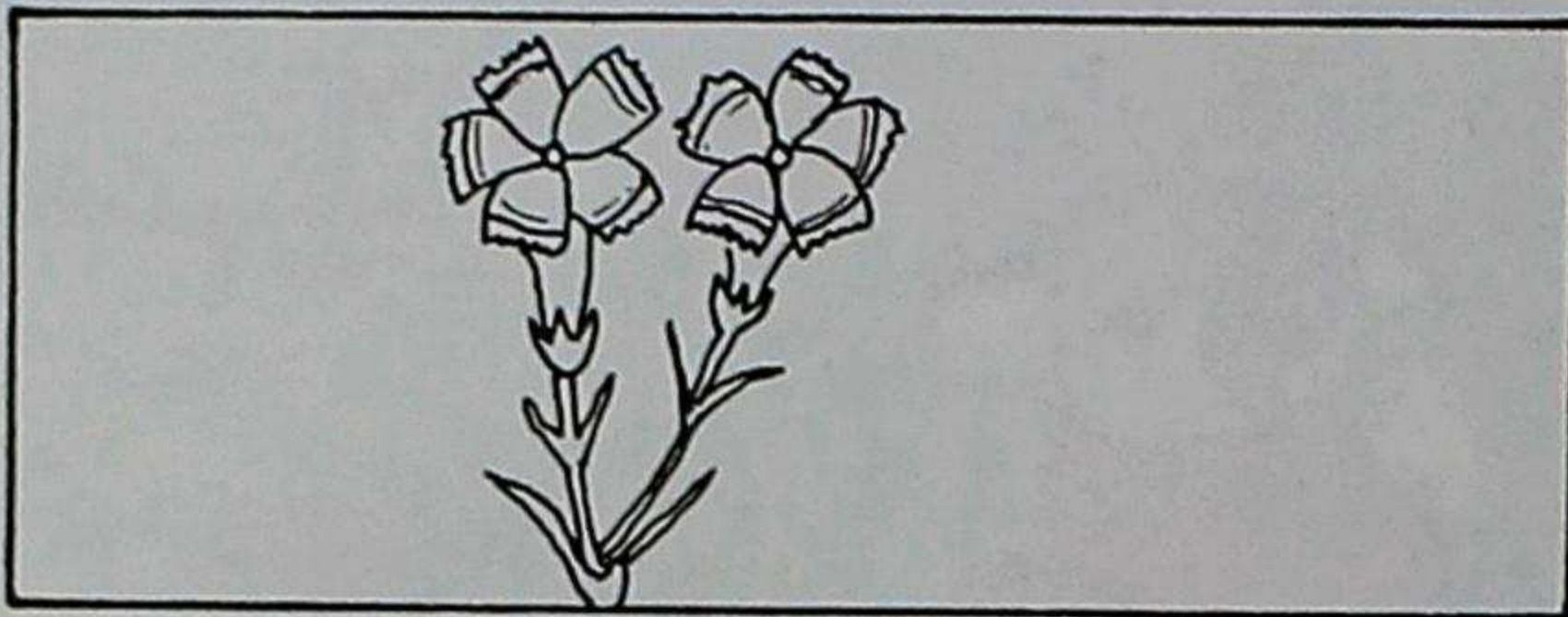

**huaita**

huau

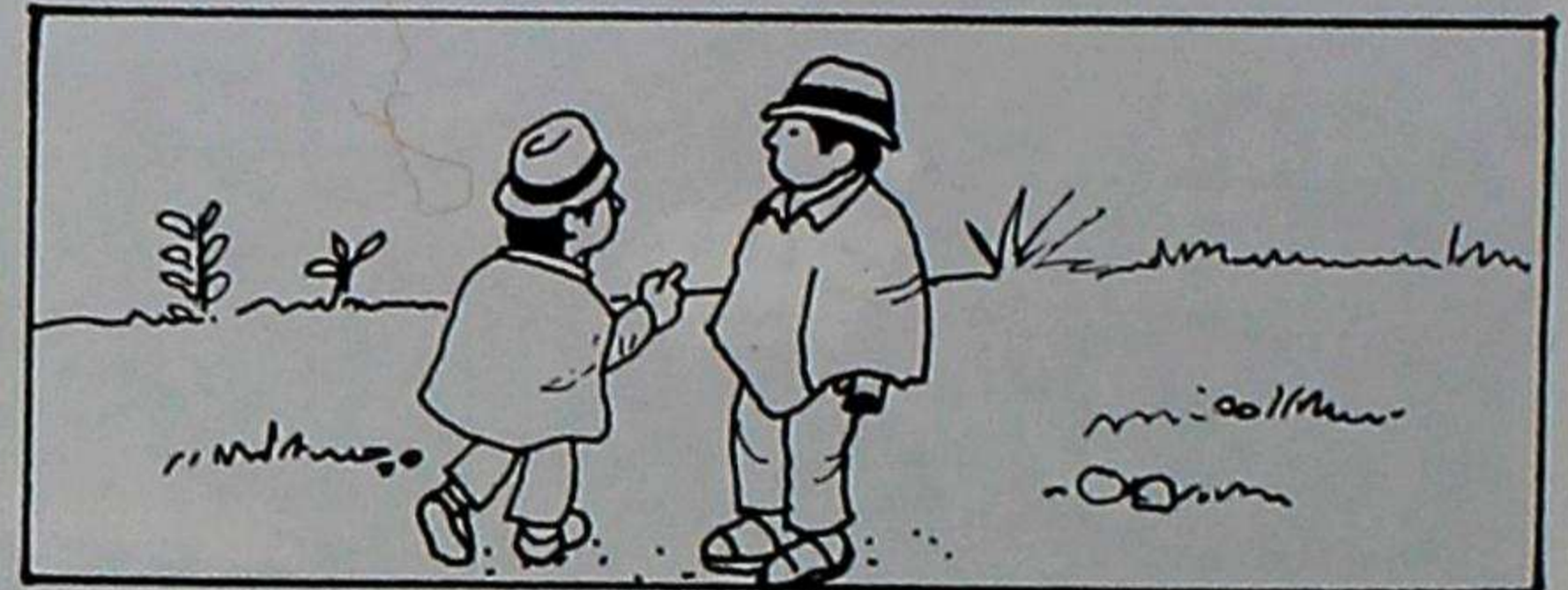

**huauqui**

ña



**ñaña**

ñu

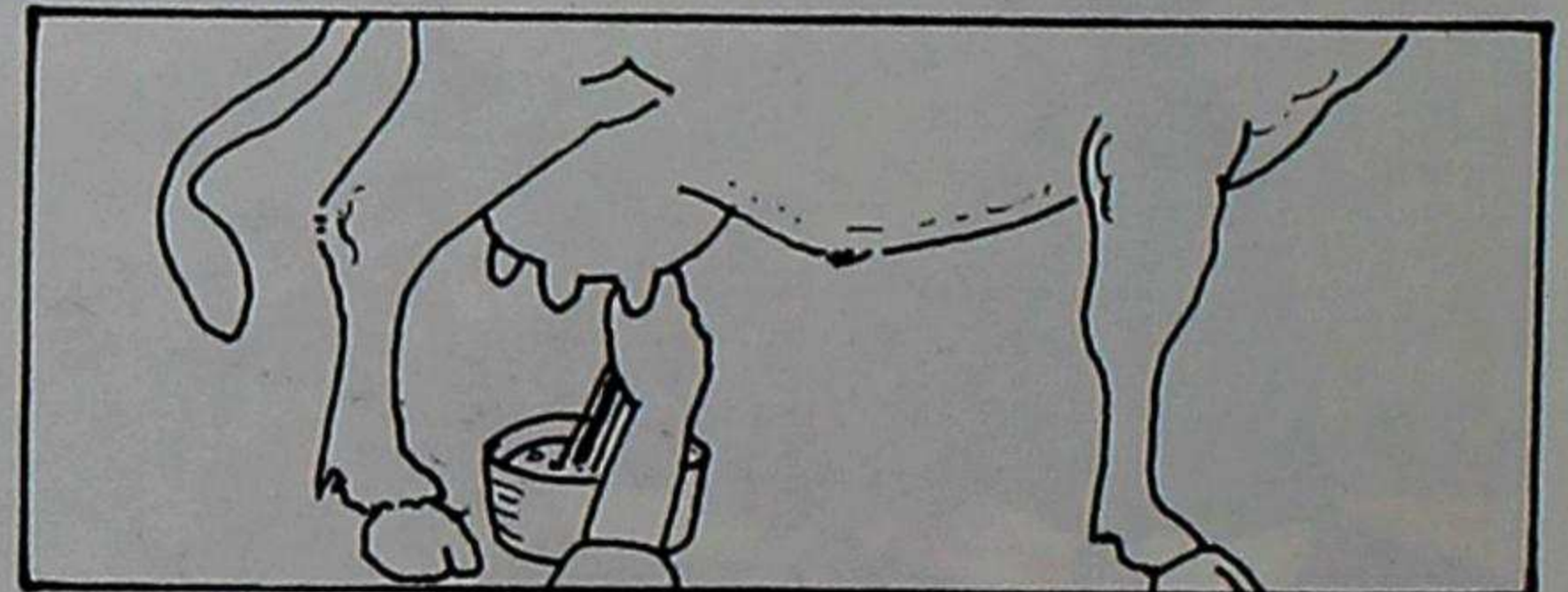

**ñuñu**

qui

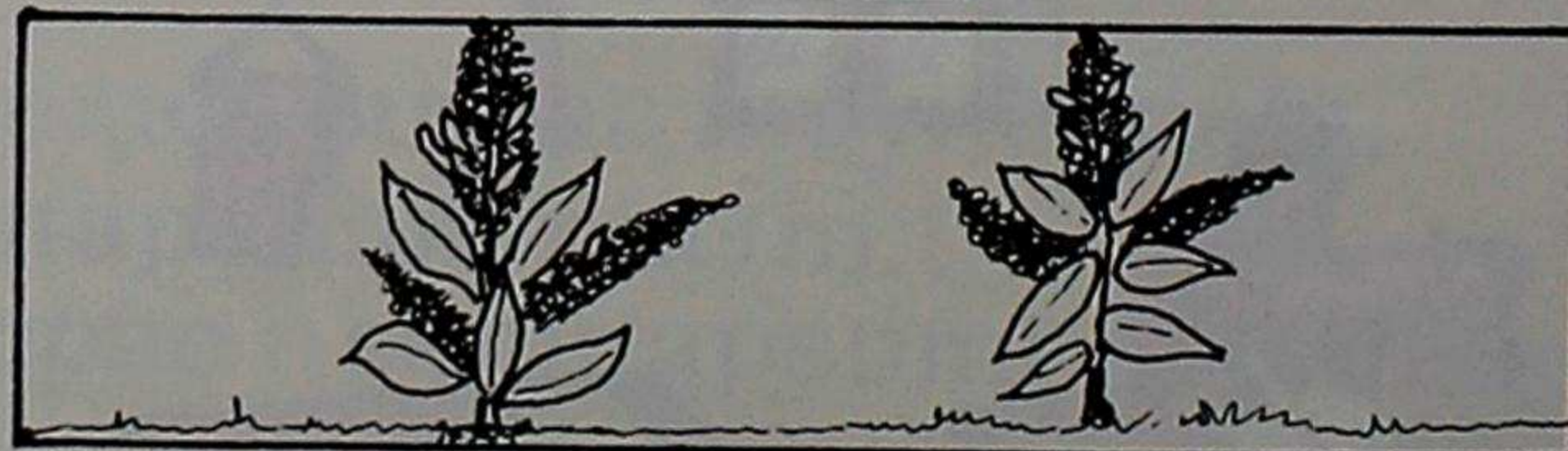

**quinua**

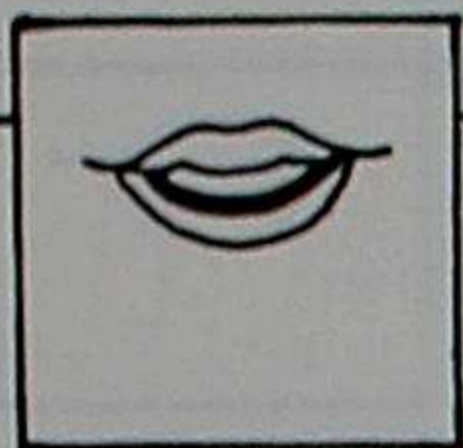

ya

yu

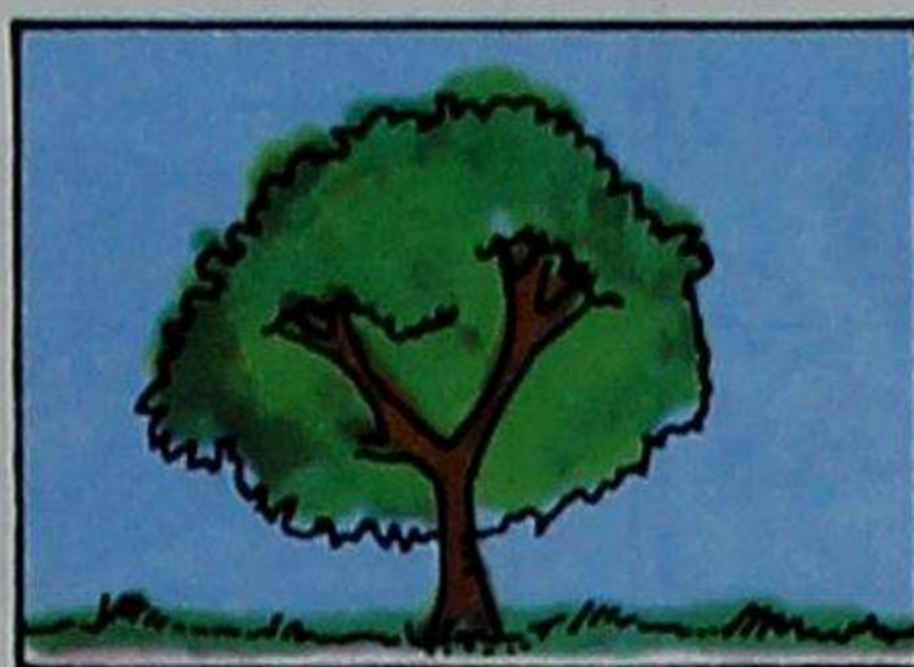
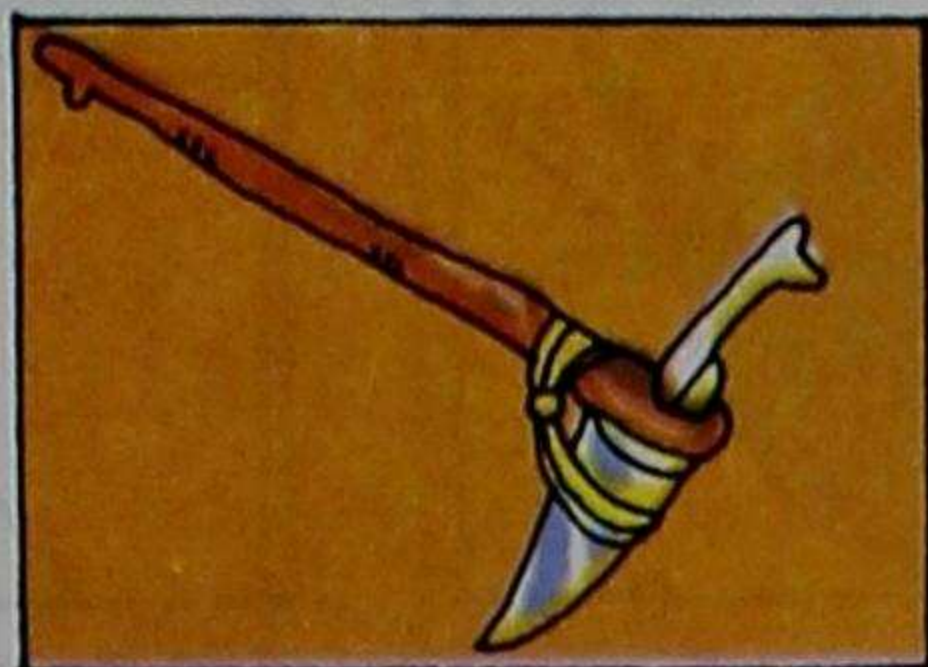

yapuna

yura

ja

ji

ju

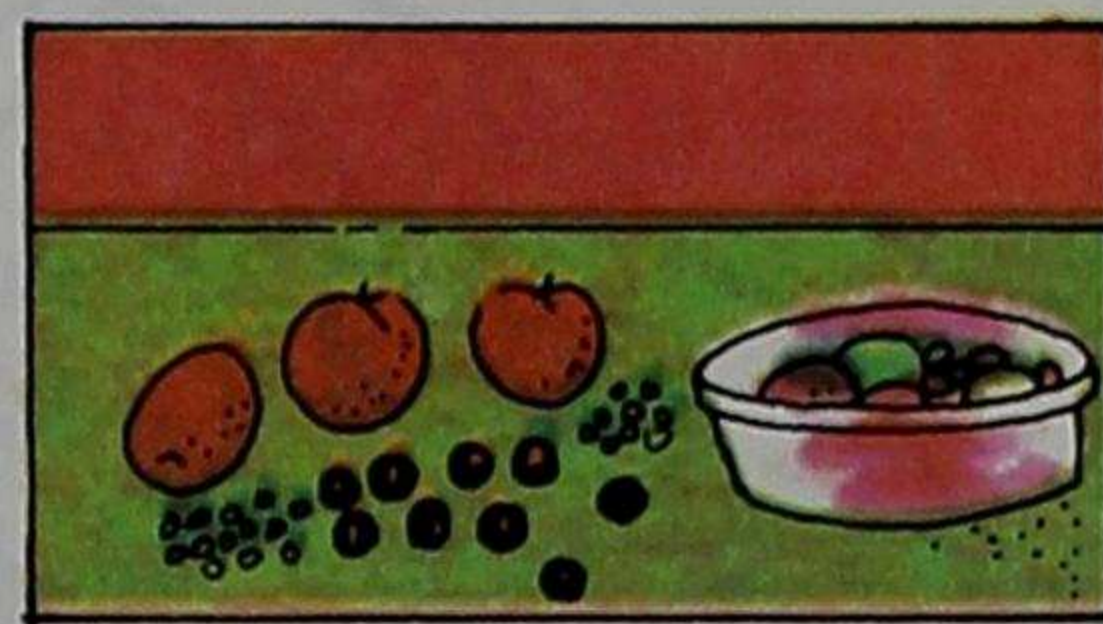
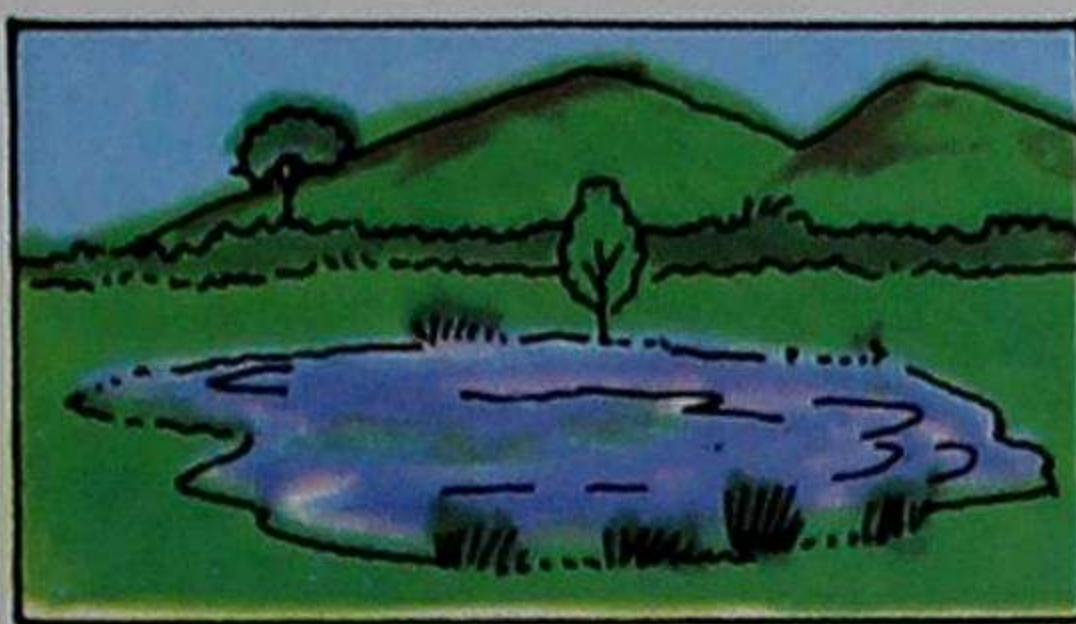
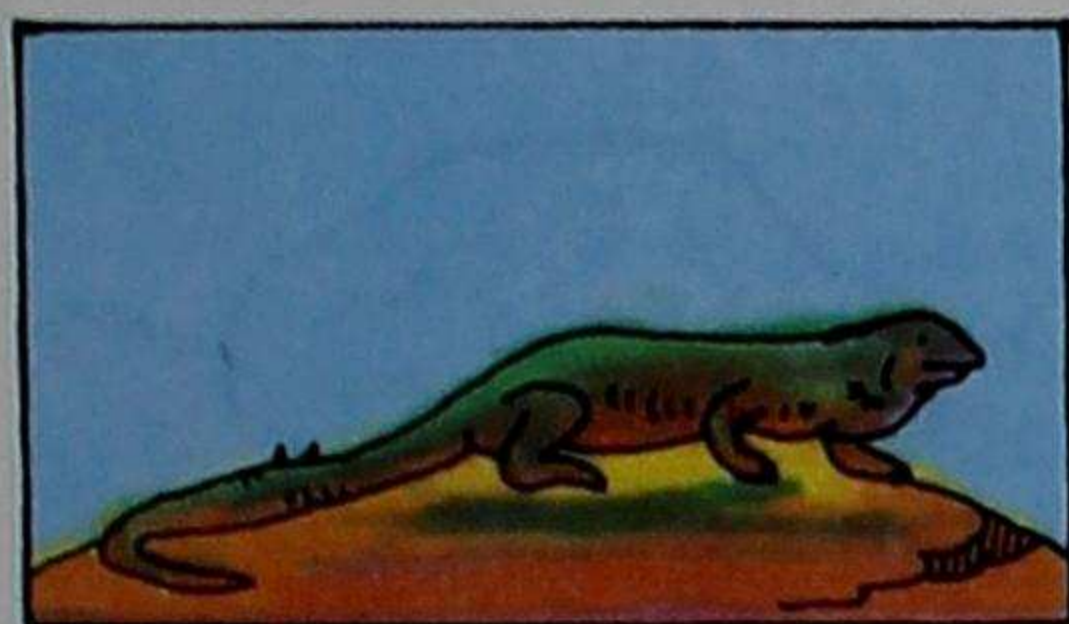

jayanpi

jita

juchu

sha

shi

shu

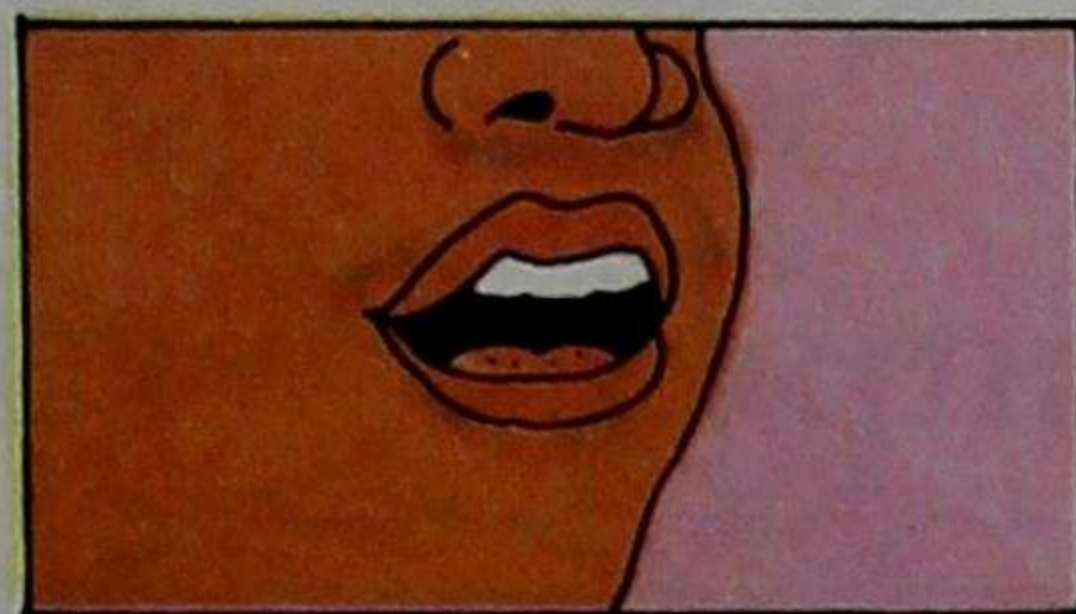

shañu

shimi

shushuna

la

li

lu

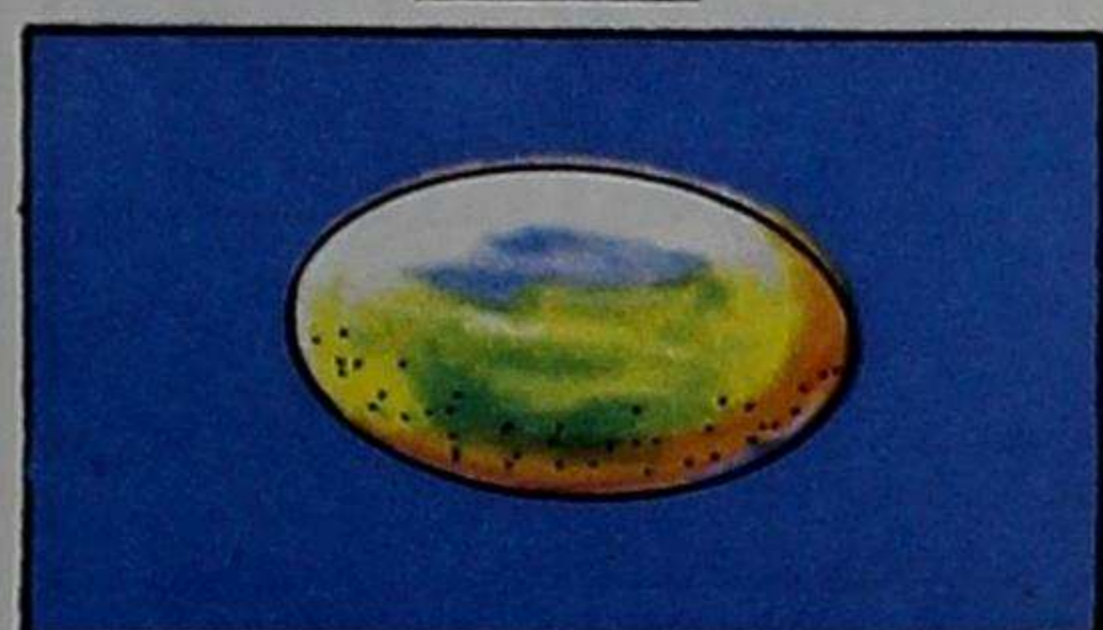
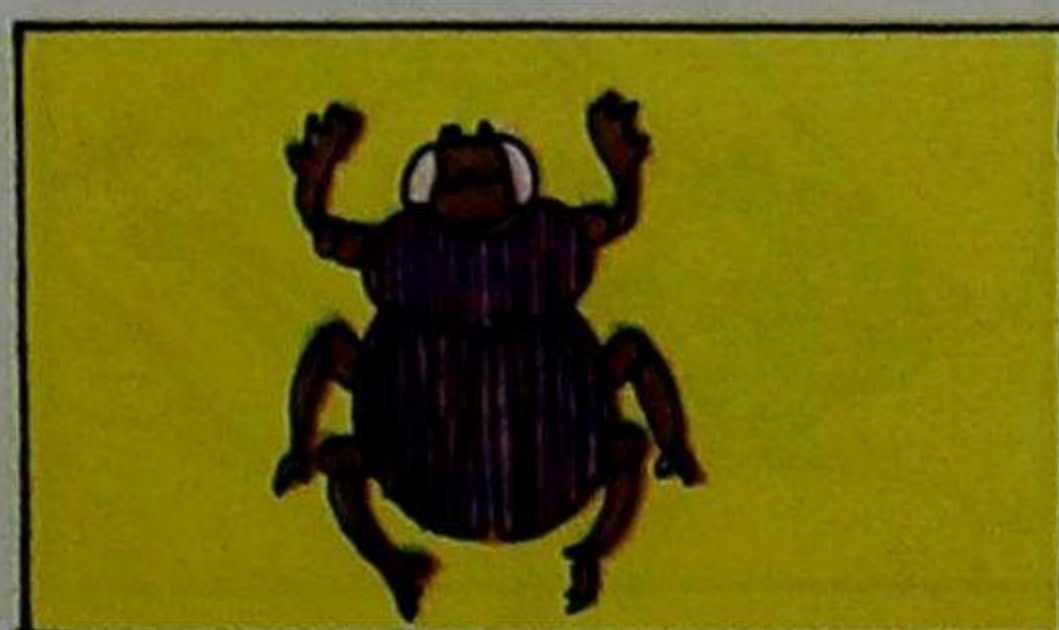

lamama

lihuar

lulun



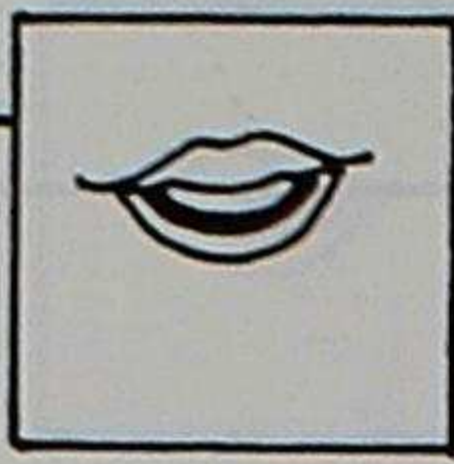

lla

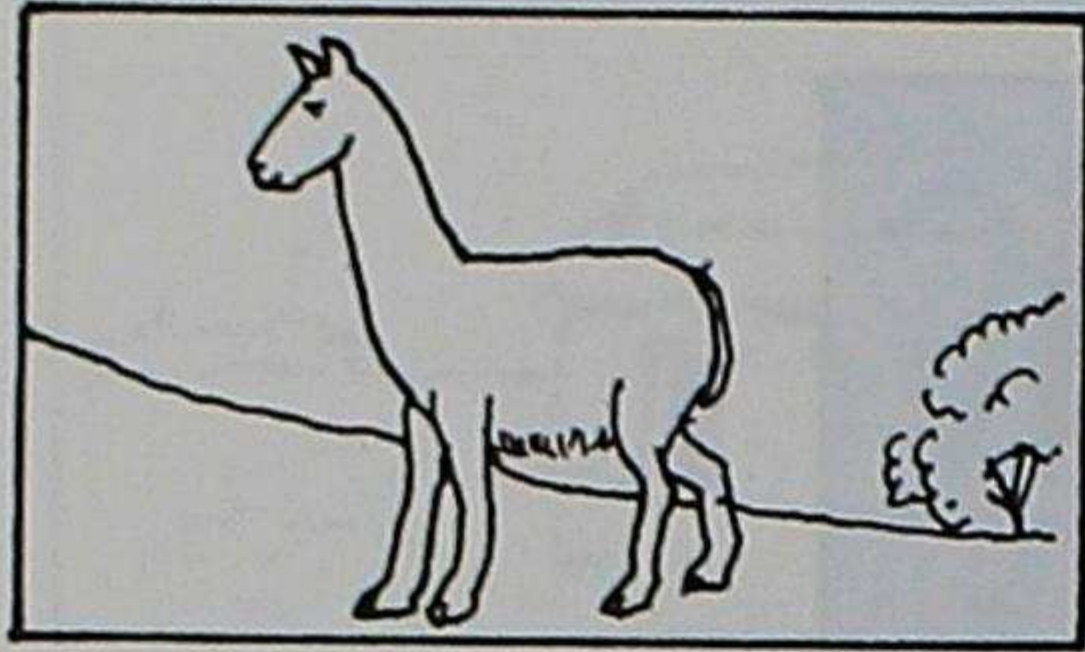

**llamincu**

lli

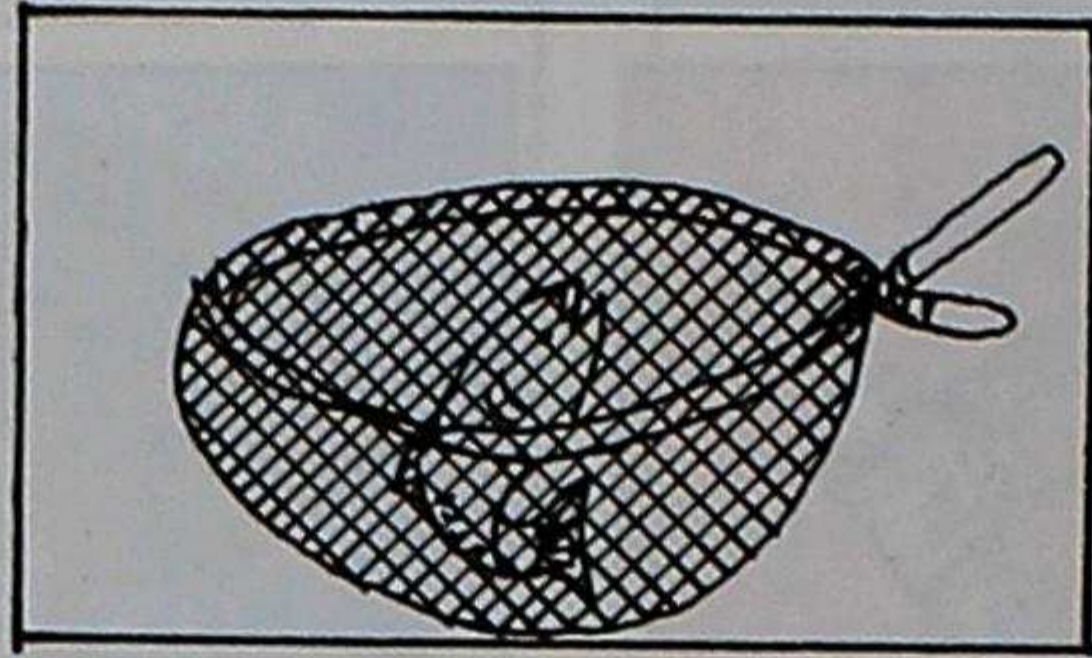

**llica**

llu

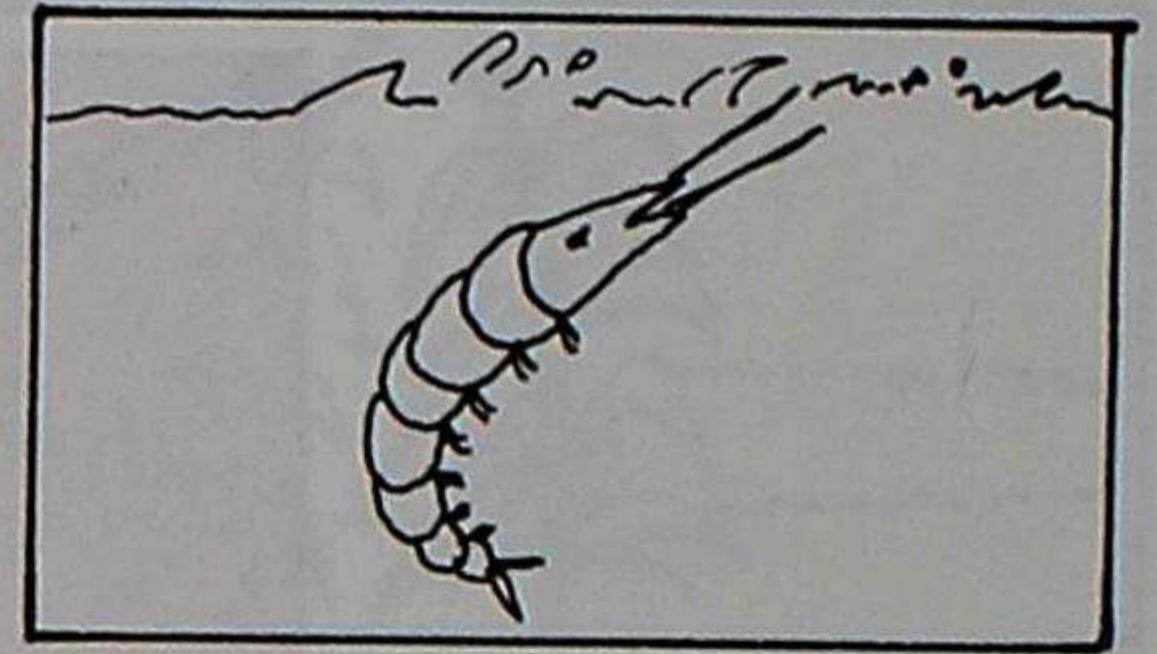

**lluchunca**

ra

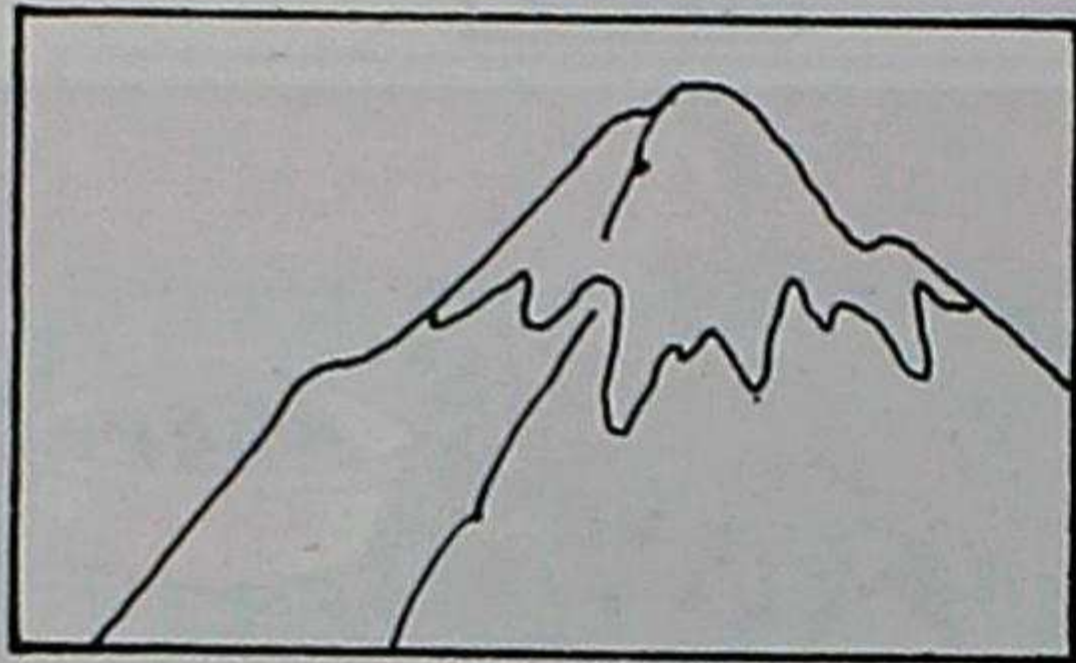

**rasu**

ri

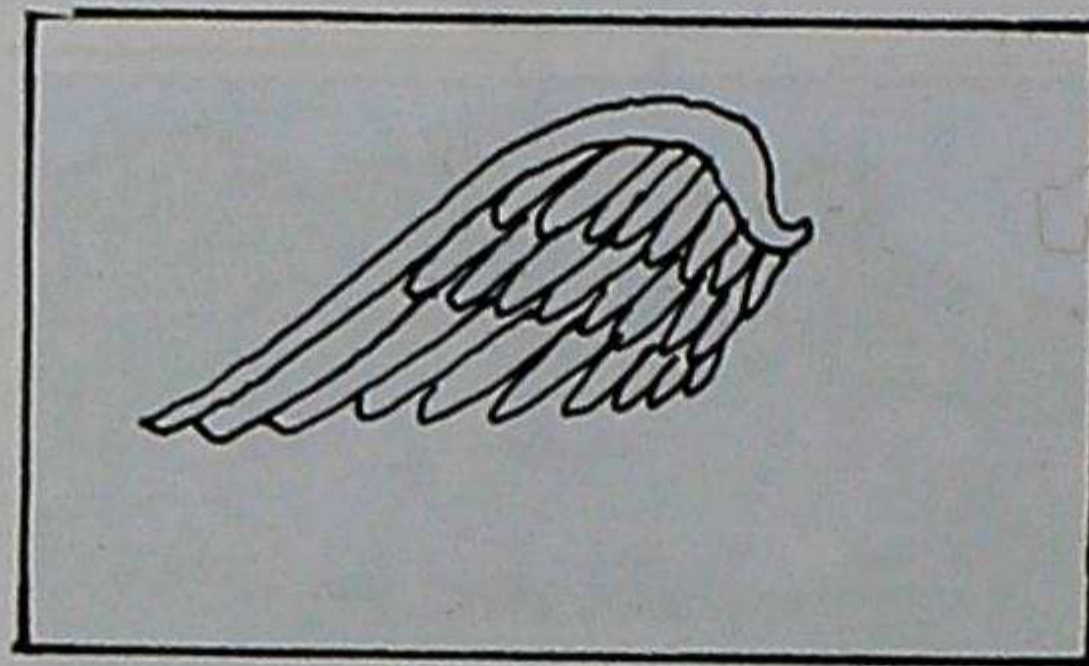

**ricra**

ru

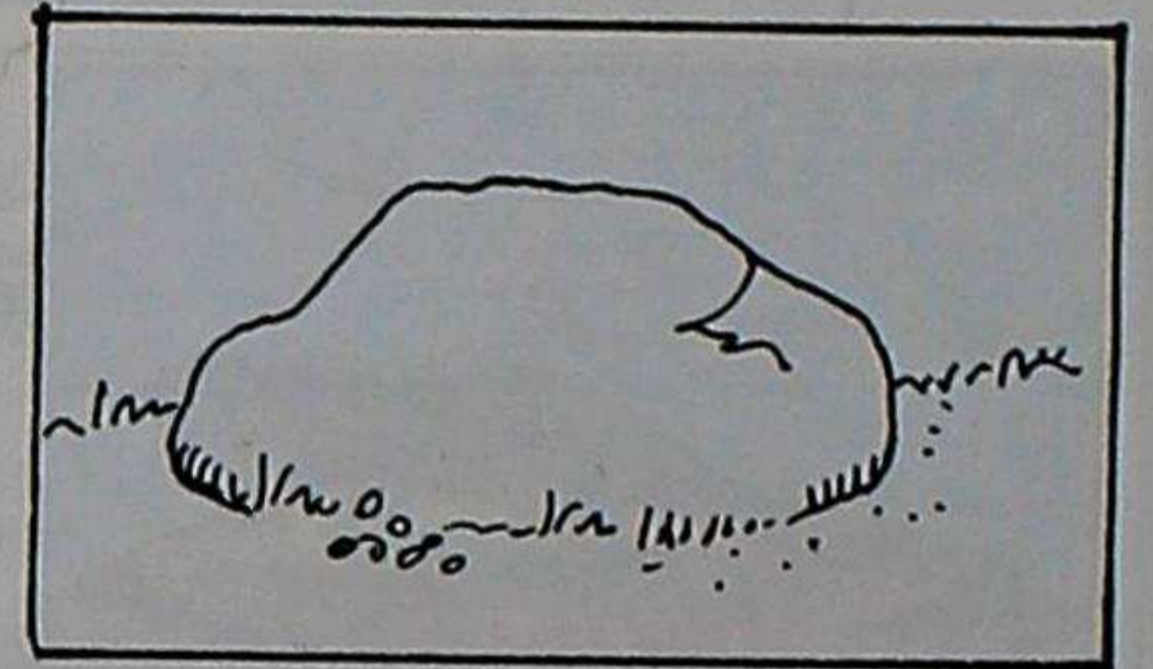

**rumi**

tσα

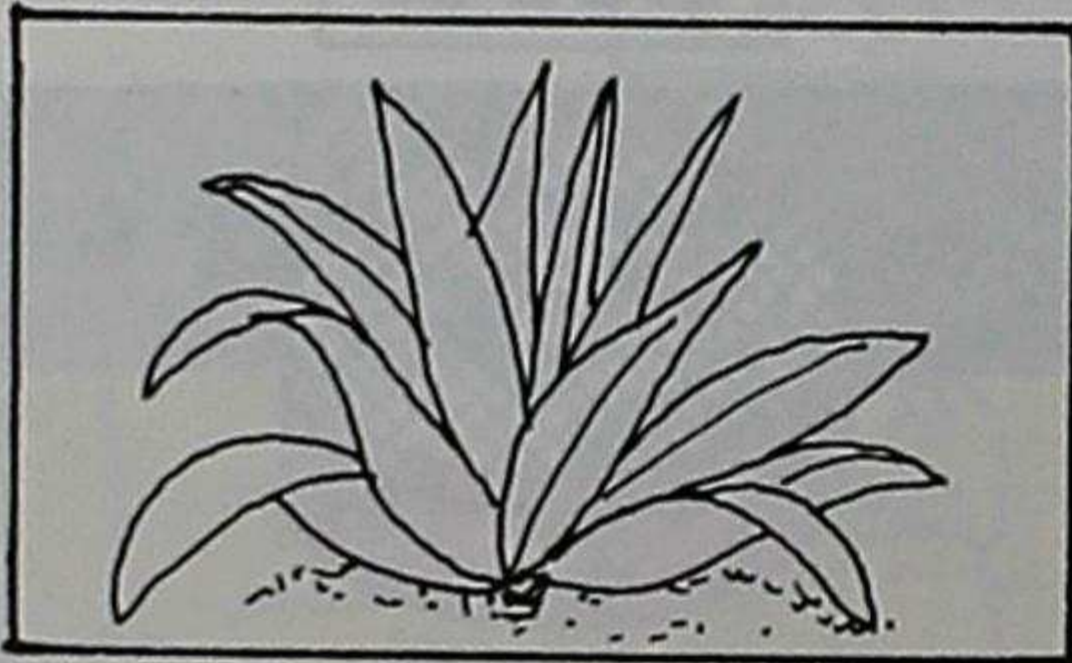

**tsahuar**

tsi

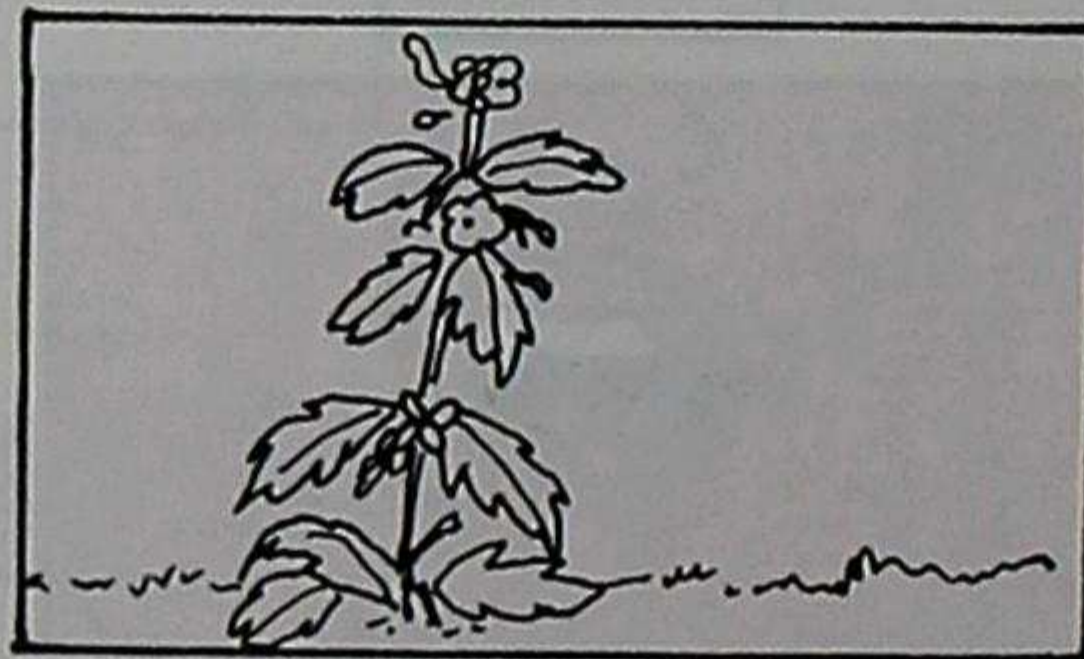

**tsini**

tsu

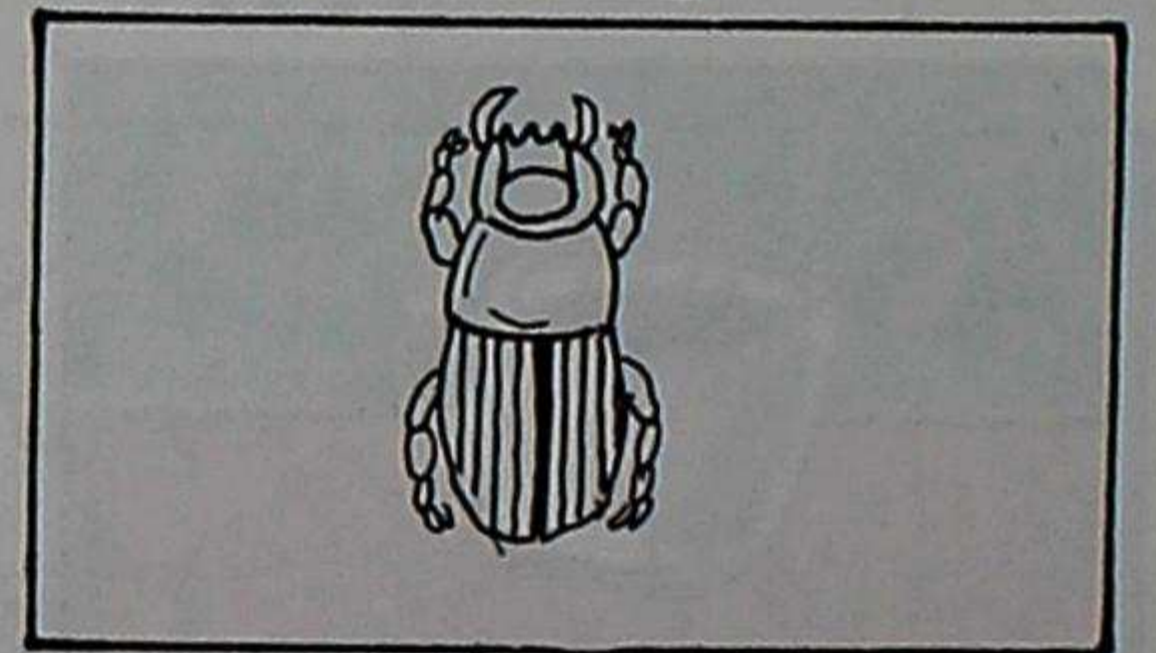

**catsu**

za

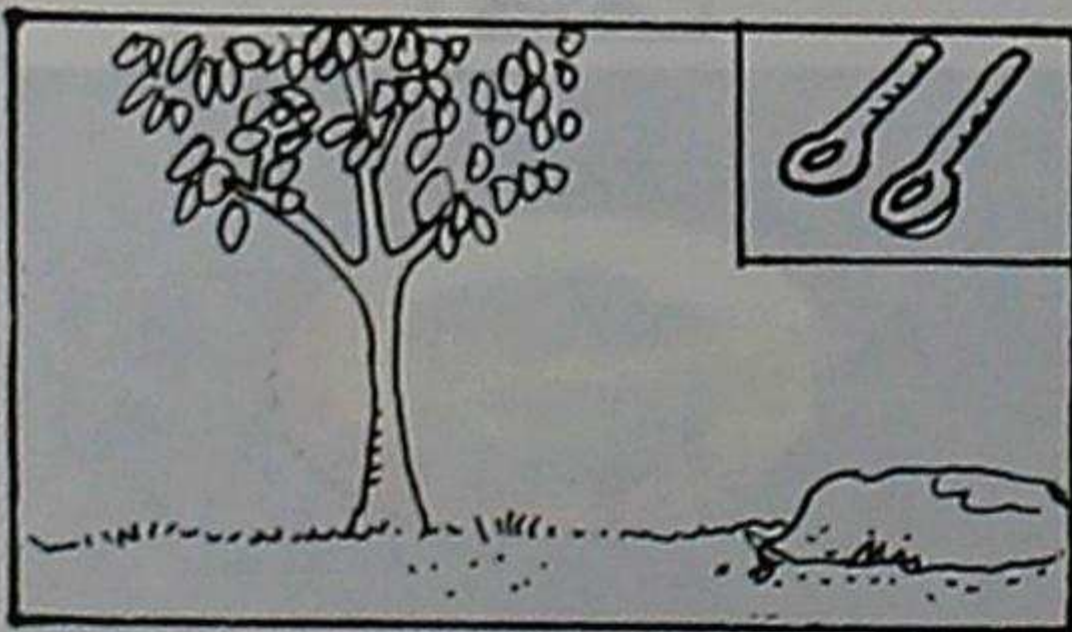

**zañas**

zi

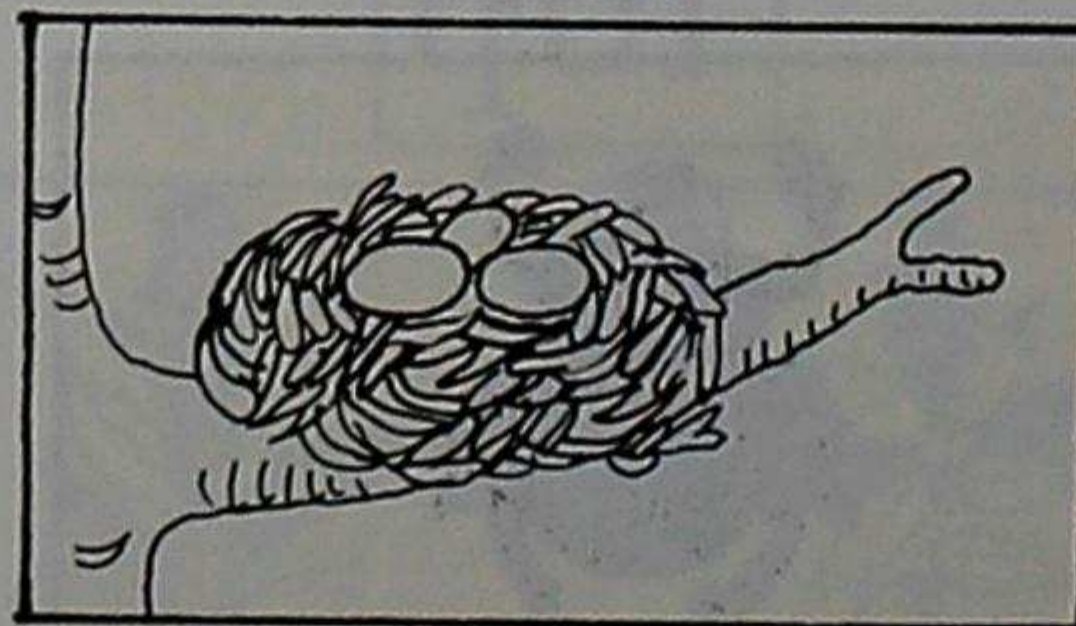

**tazin**

zu

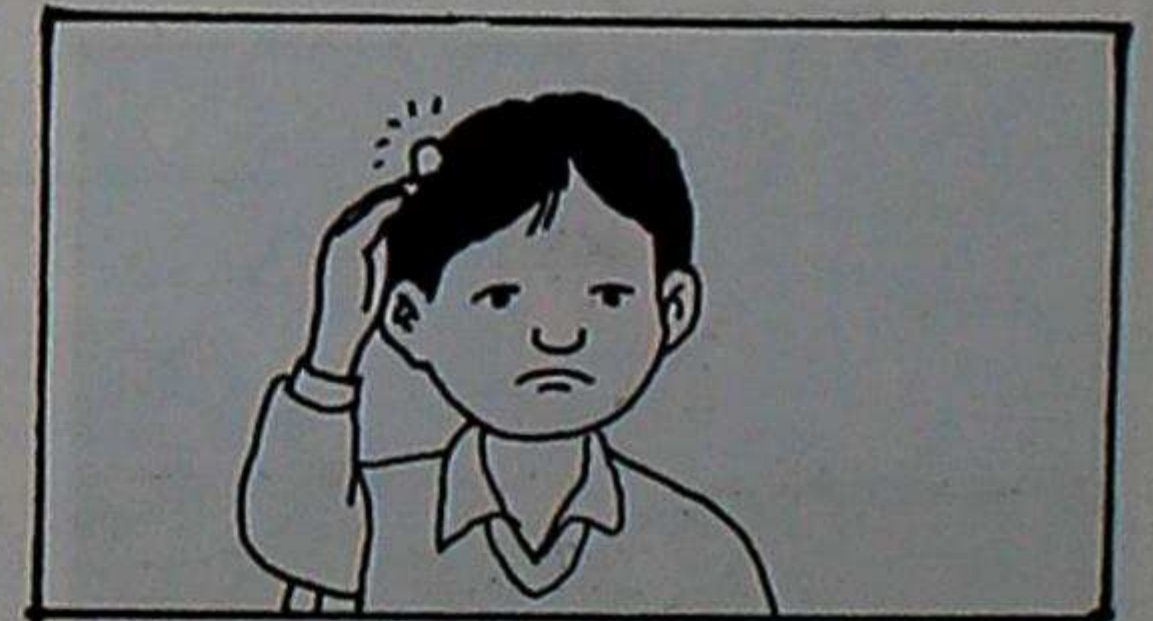

**zupu**

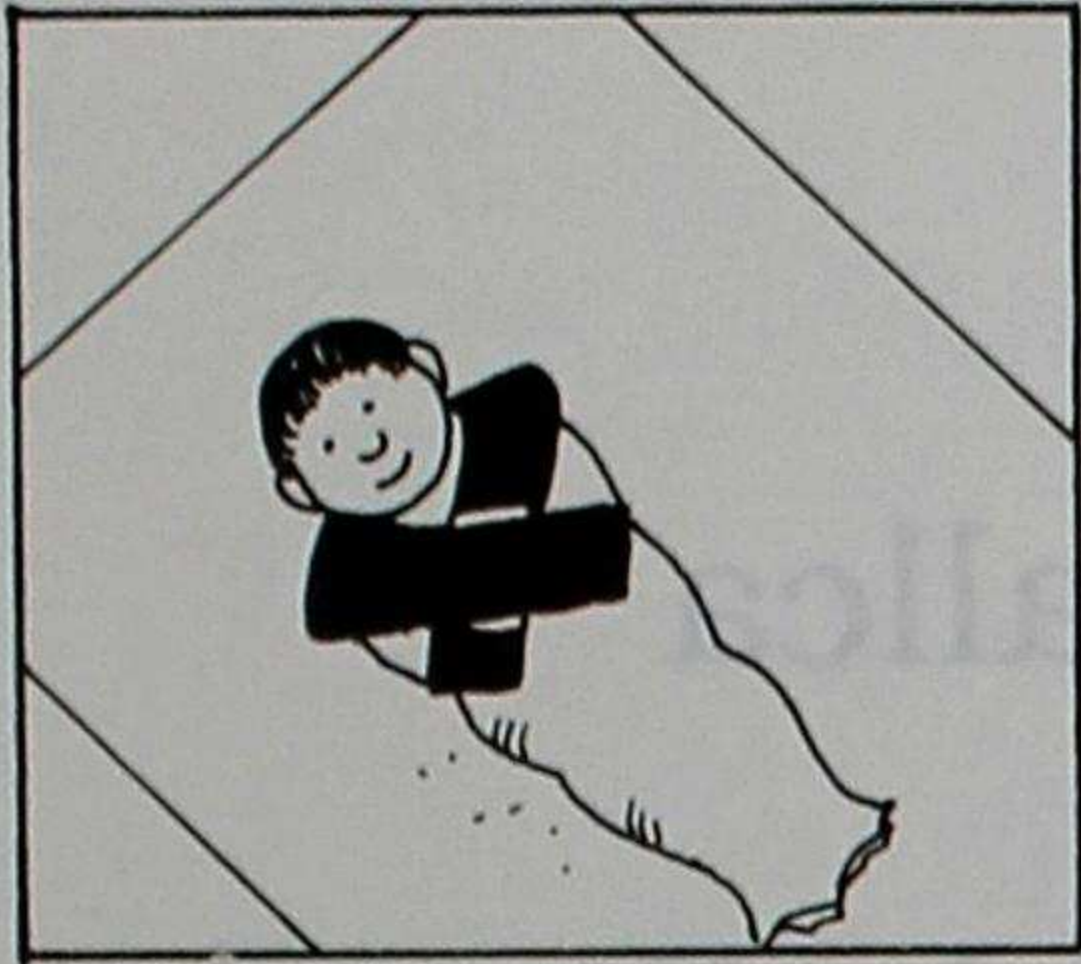
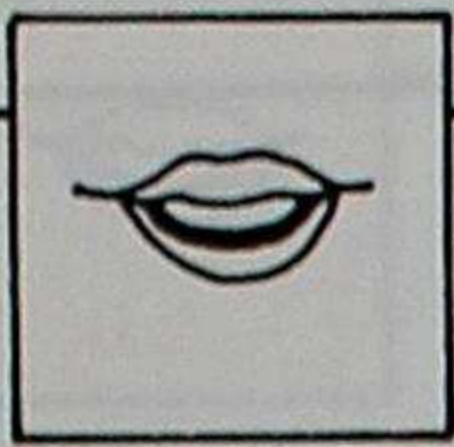

cunca



tuncu

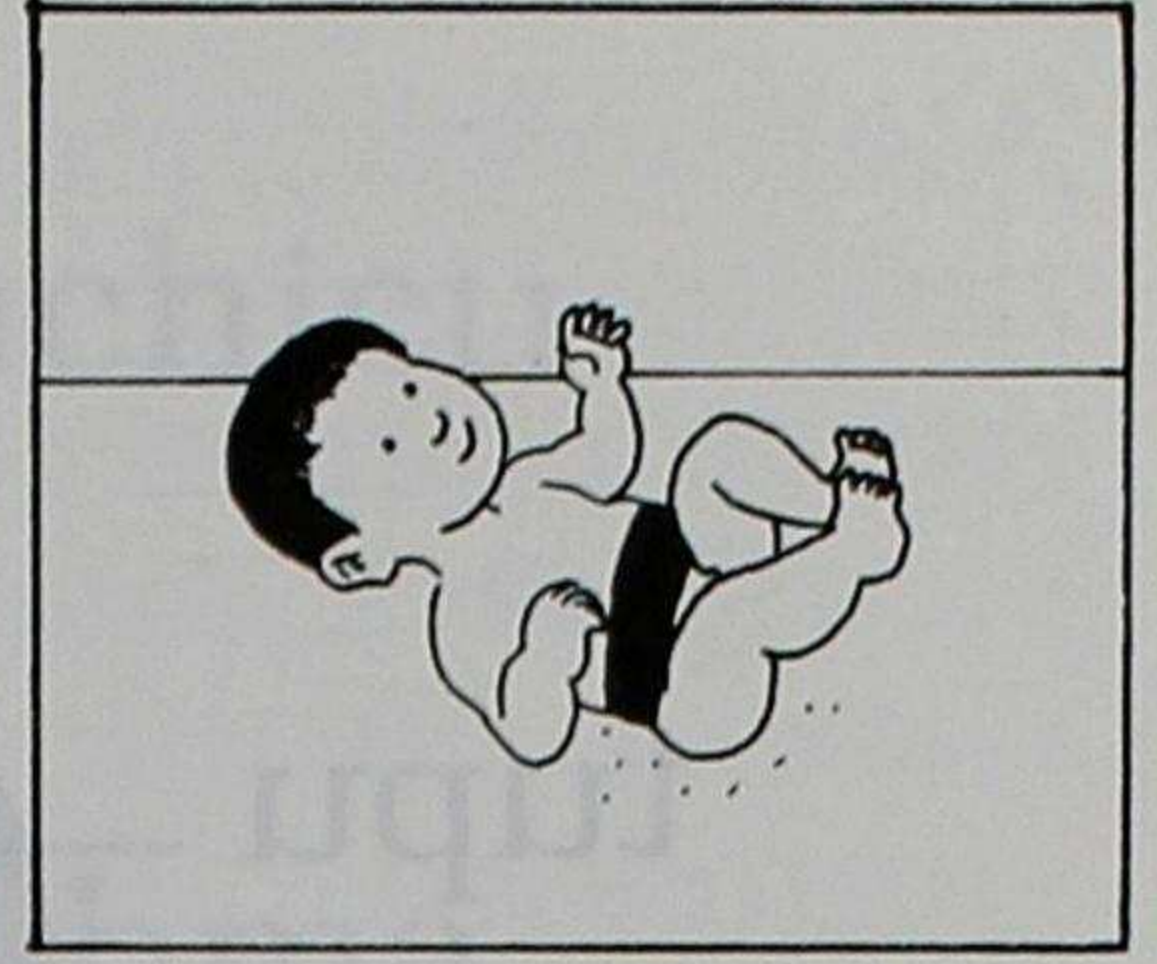

pupuchunpi

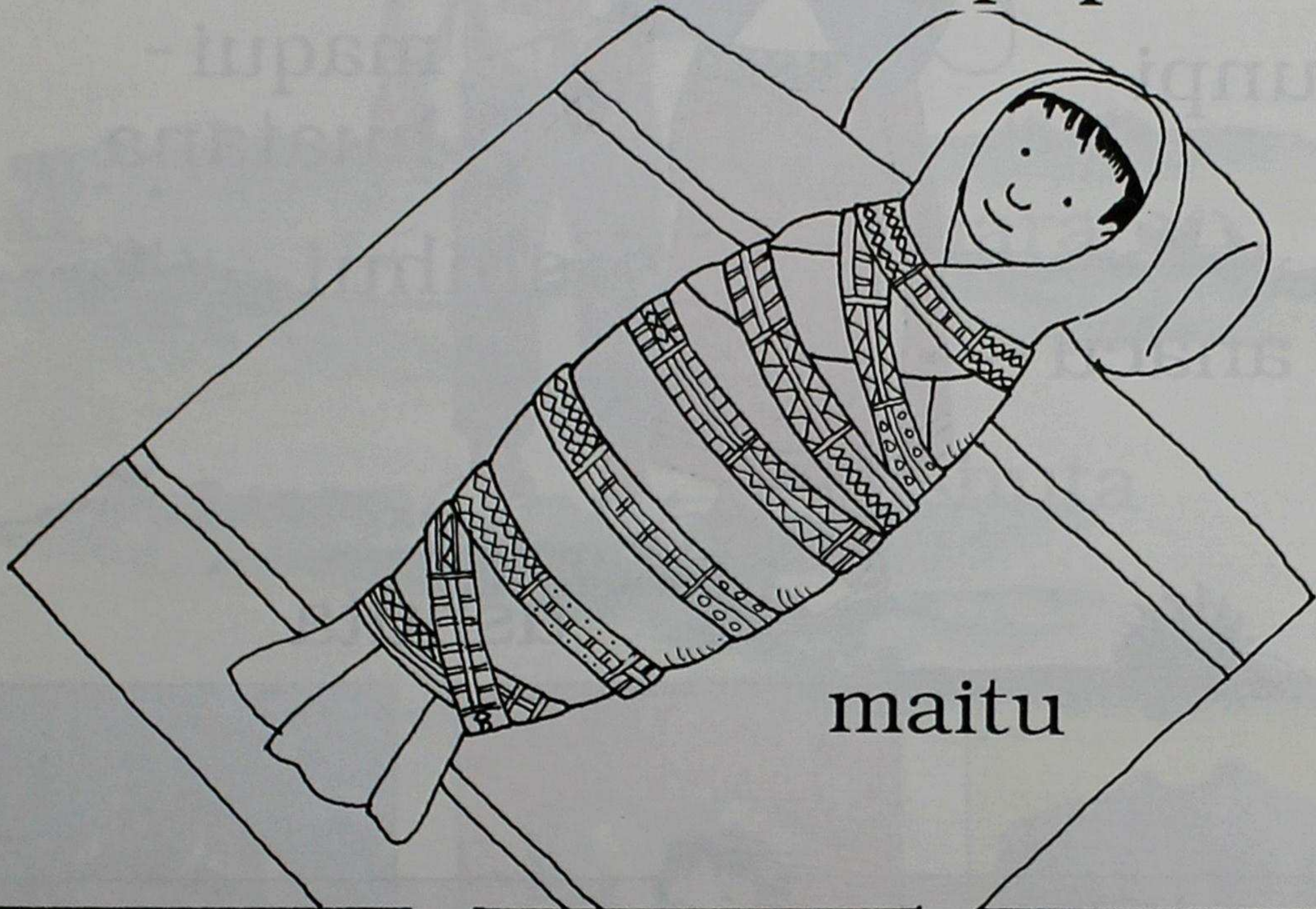

maitu



siquipilluna

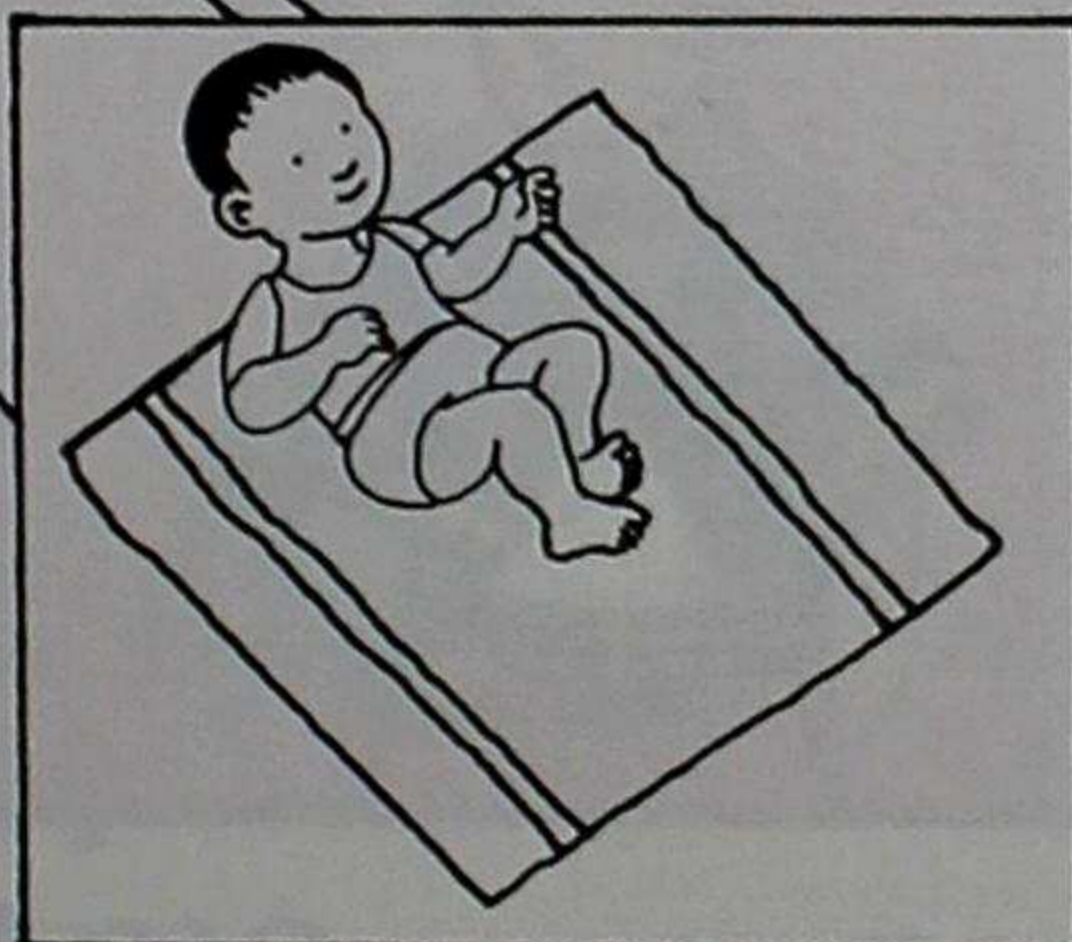

maituna

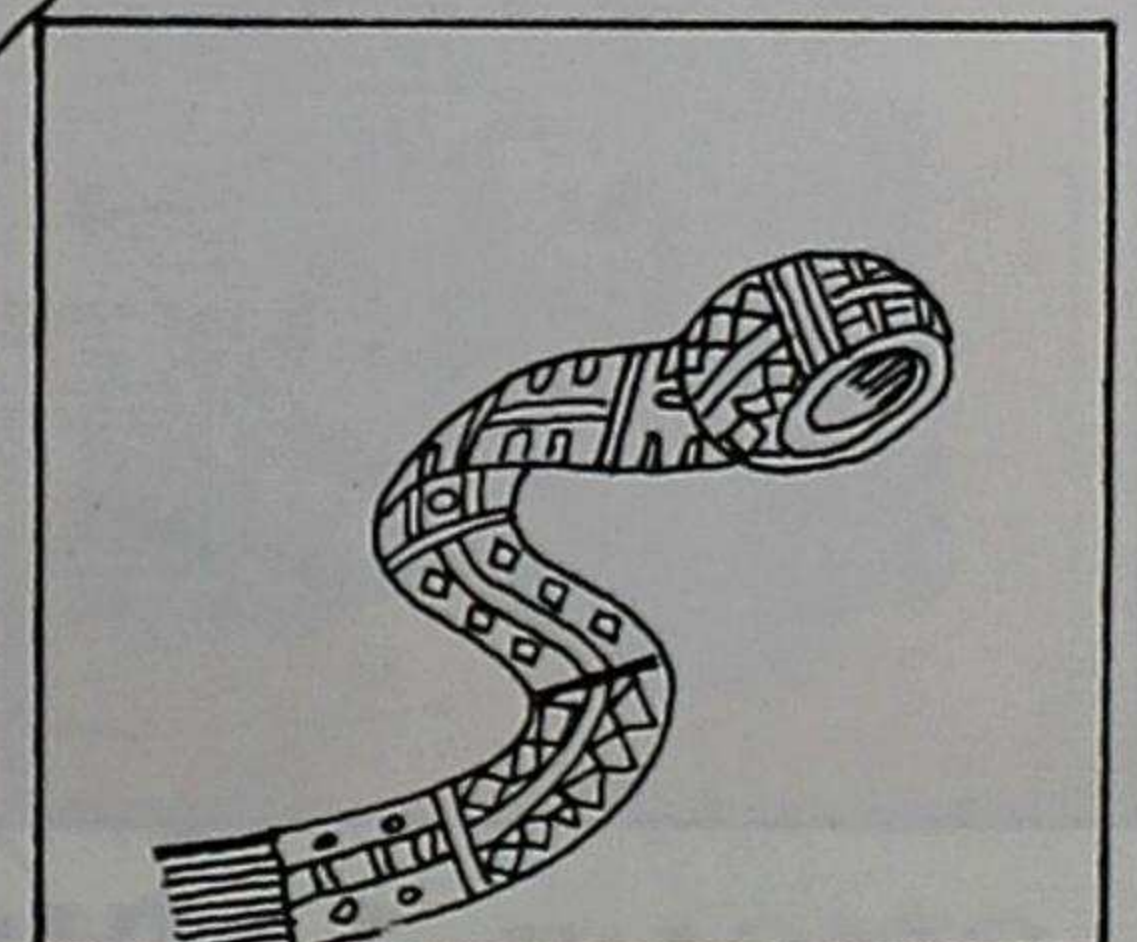

chunpi

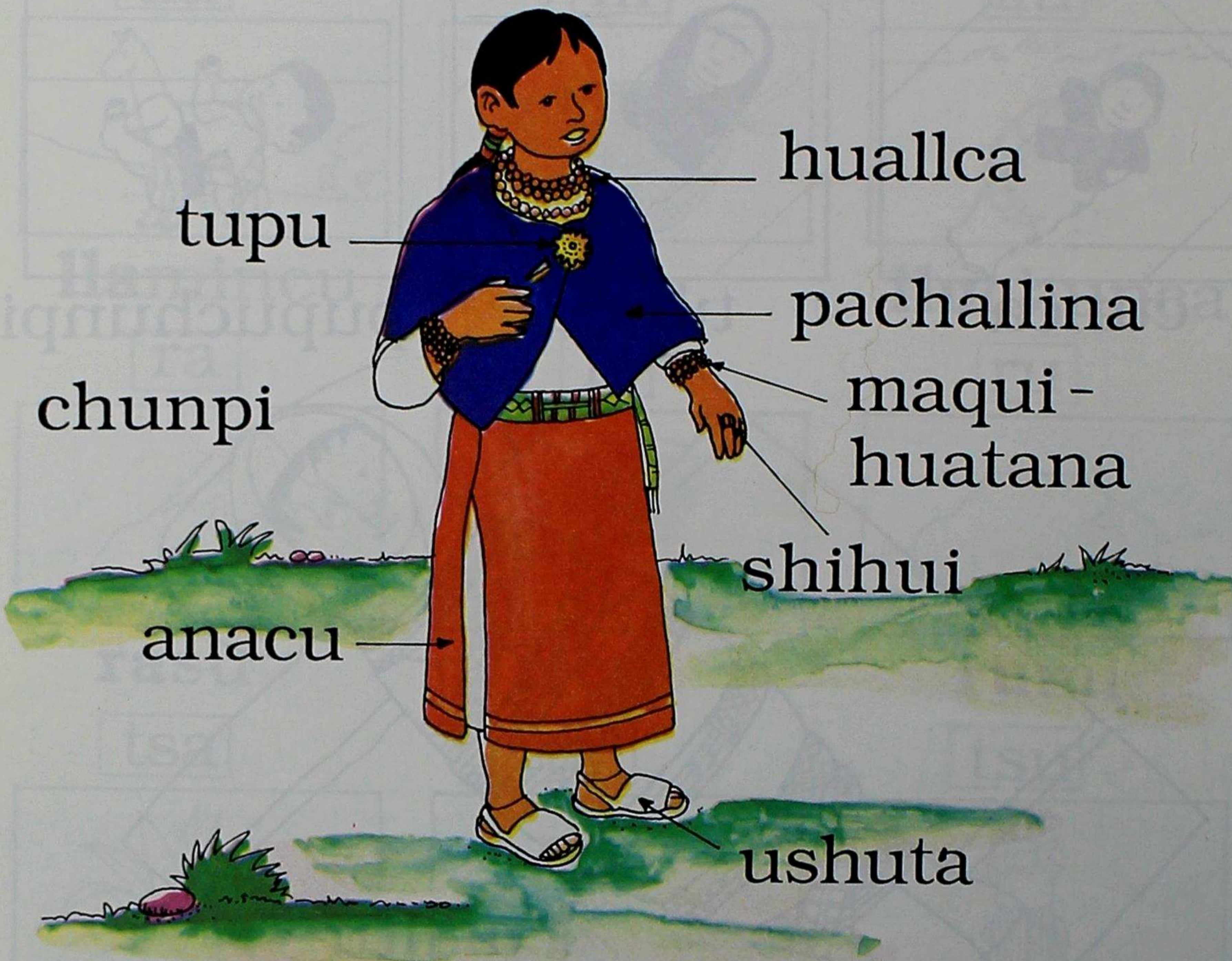
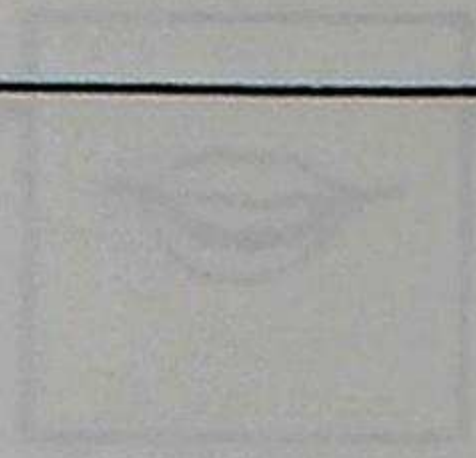
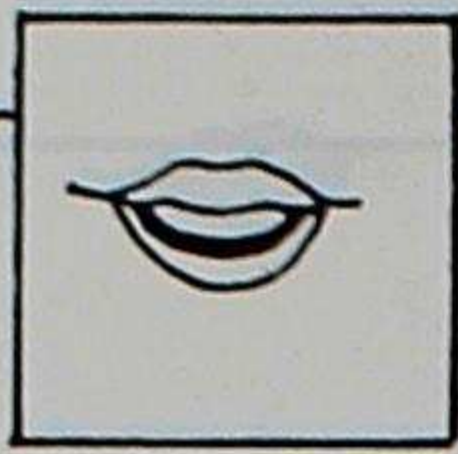

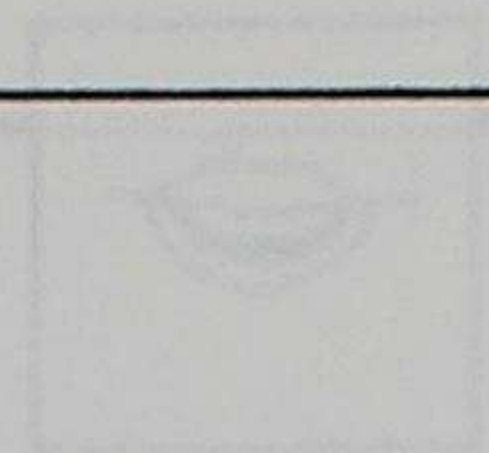
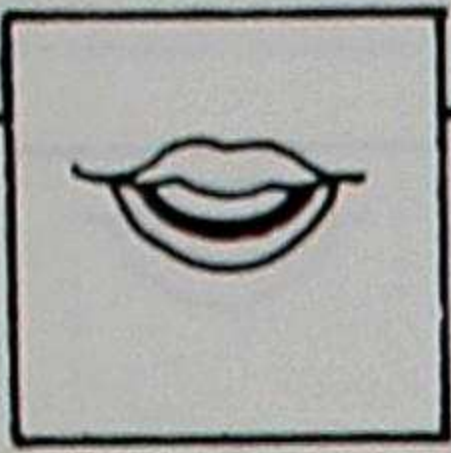

muchicu

cushma

huara

ushuta

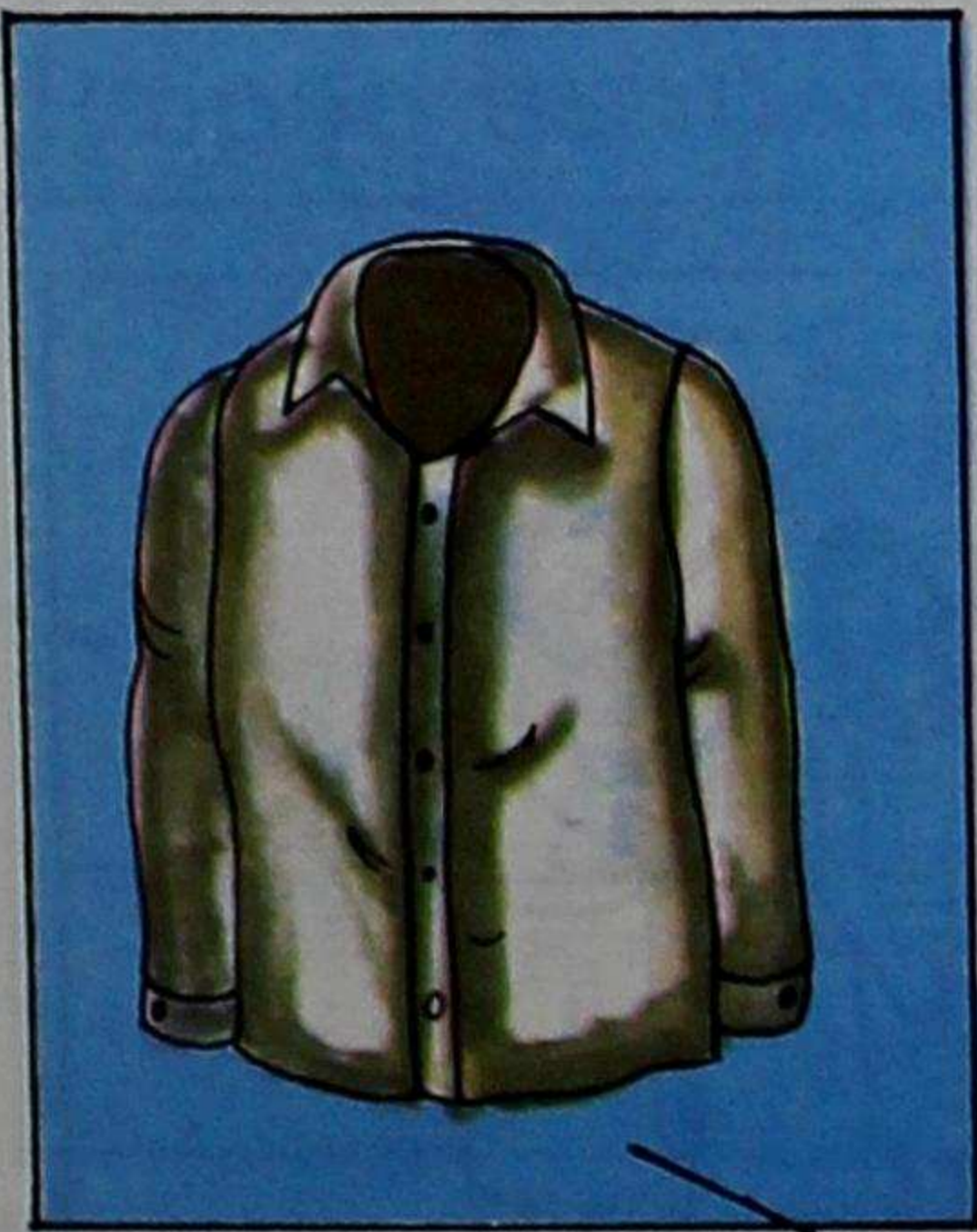

cushma

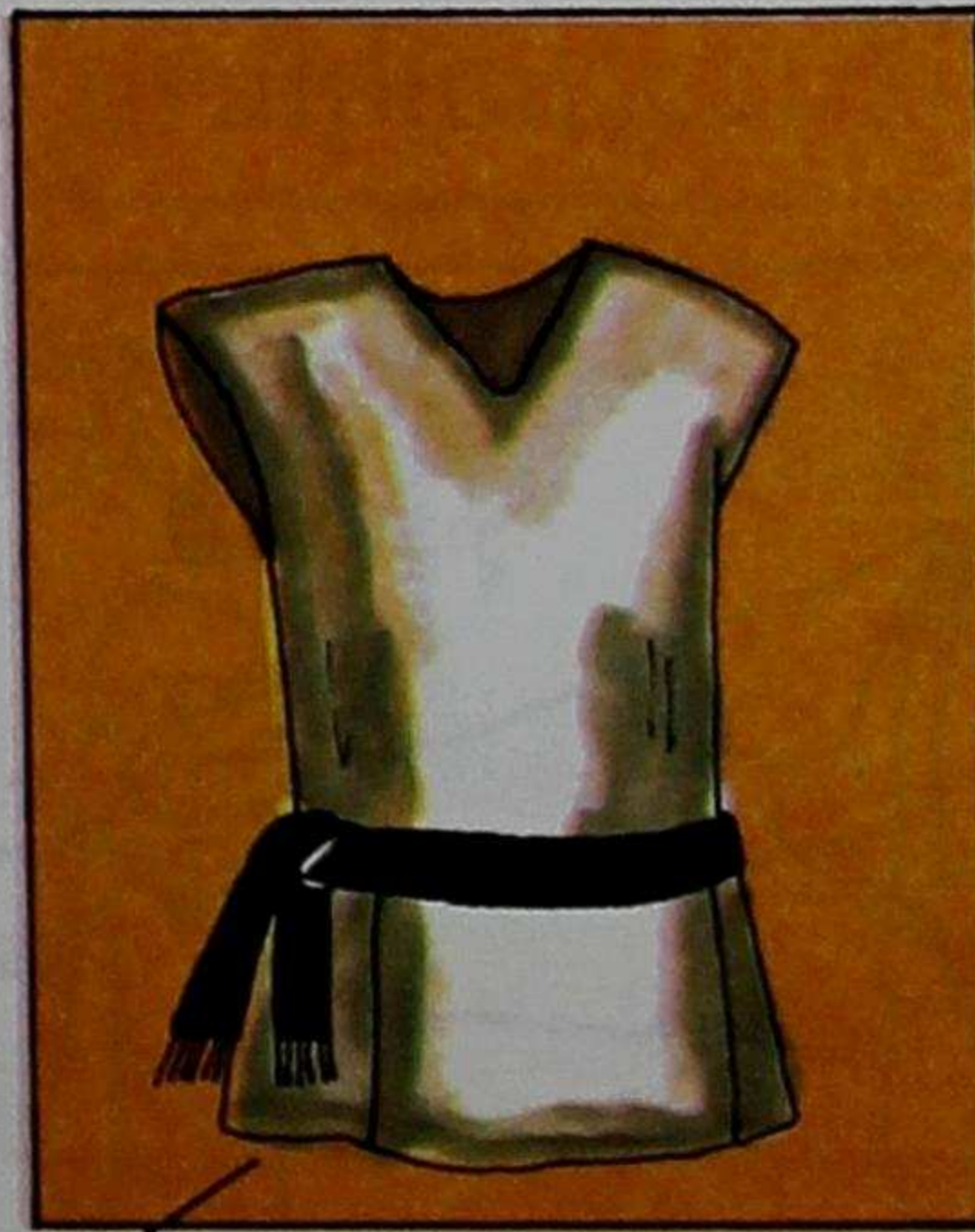

punchu

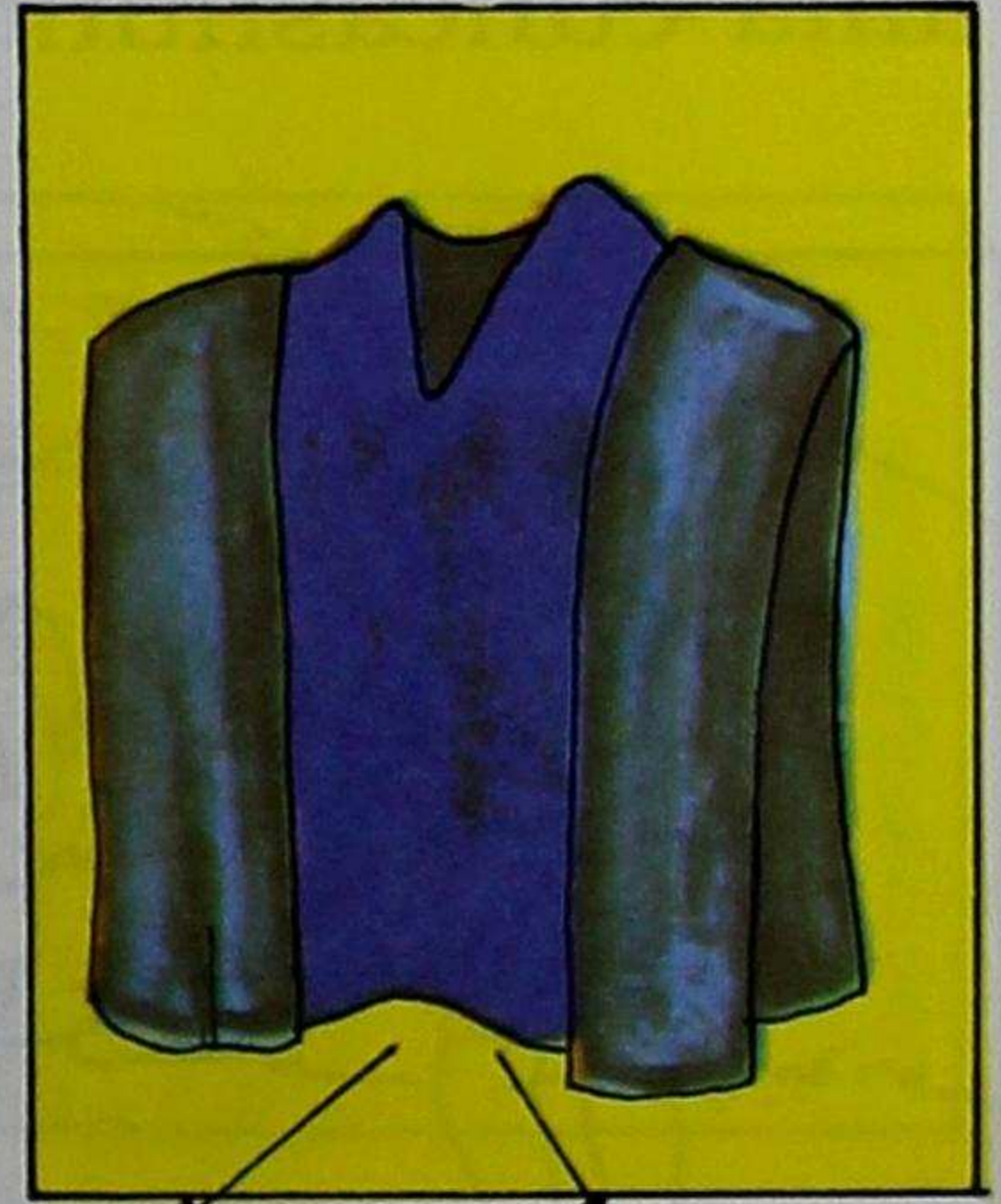

ruana

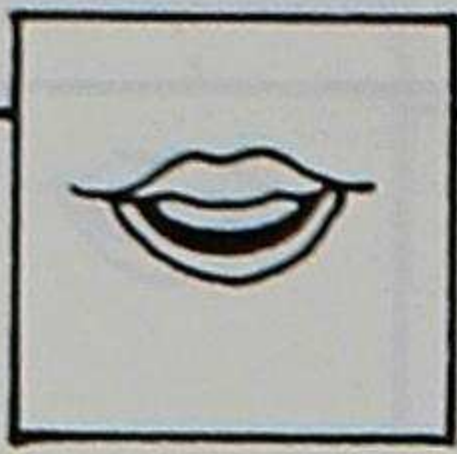

## Atahualpapak churarinamanta

Atahualpa inca huishcashca cACPica,  
quillcac Pizarroca ricuncapac shamushca nin.  
Atahualpapak churanata  
ricushpaca mancharishcami nin.  
Canpac churacushcataca picunatac  
canmanca camarin nishpami  
Pizarroca tapushca.

Ñucamanca Tumbezmanta runacunami cai  
ahuashcataca camarihuan, nishpami  
Atahualpaca cutichishca.

Cai churanaca mashu millmahuanmi  
ahuashca cashca, shinallatac, sumaclla  
saquirichunca curihuan, antahuan,  
cullquihuanpash allichishcami cashca.

Cunan pachapica mushuc ahuanacunapimi  
millmahuan, utcuhuan, shuctac  
pushcacunahuanpash ahuncuna.

Shinaca, ñucanchic sumac churanacunataca  
ama cuncashunchic.

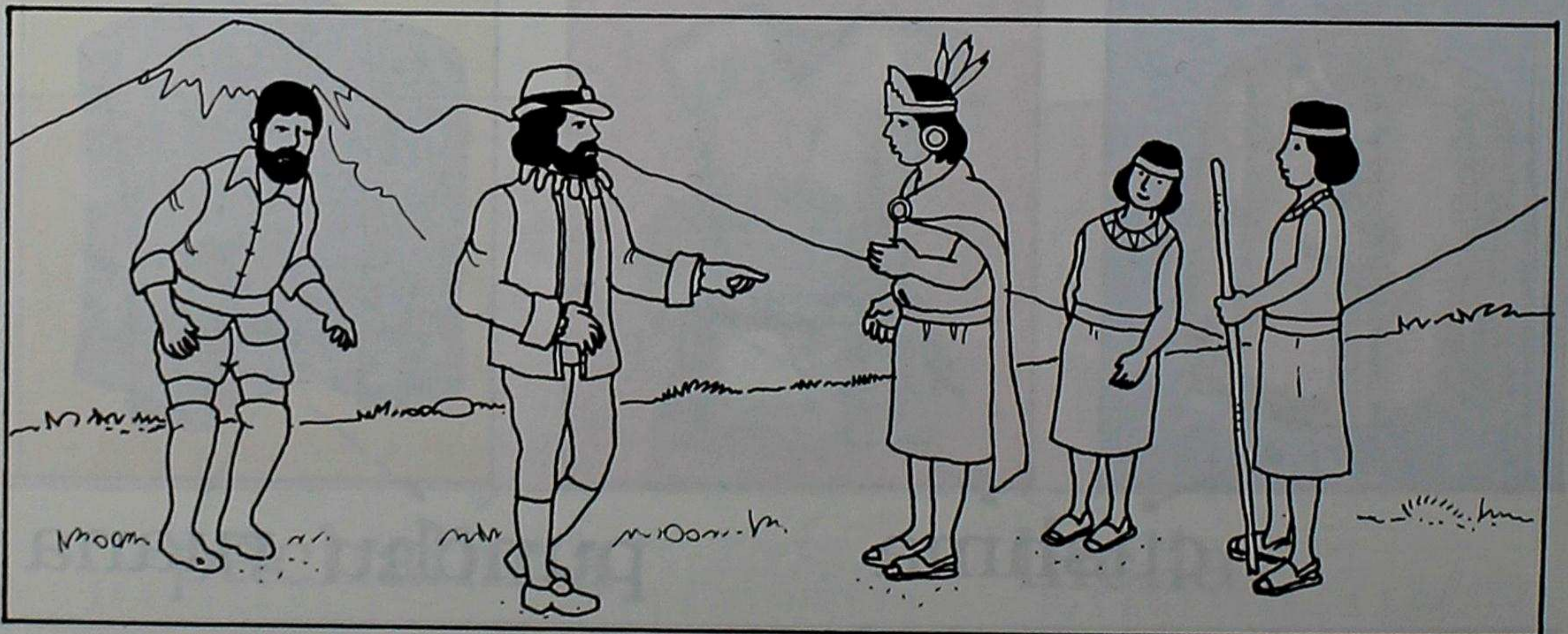

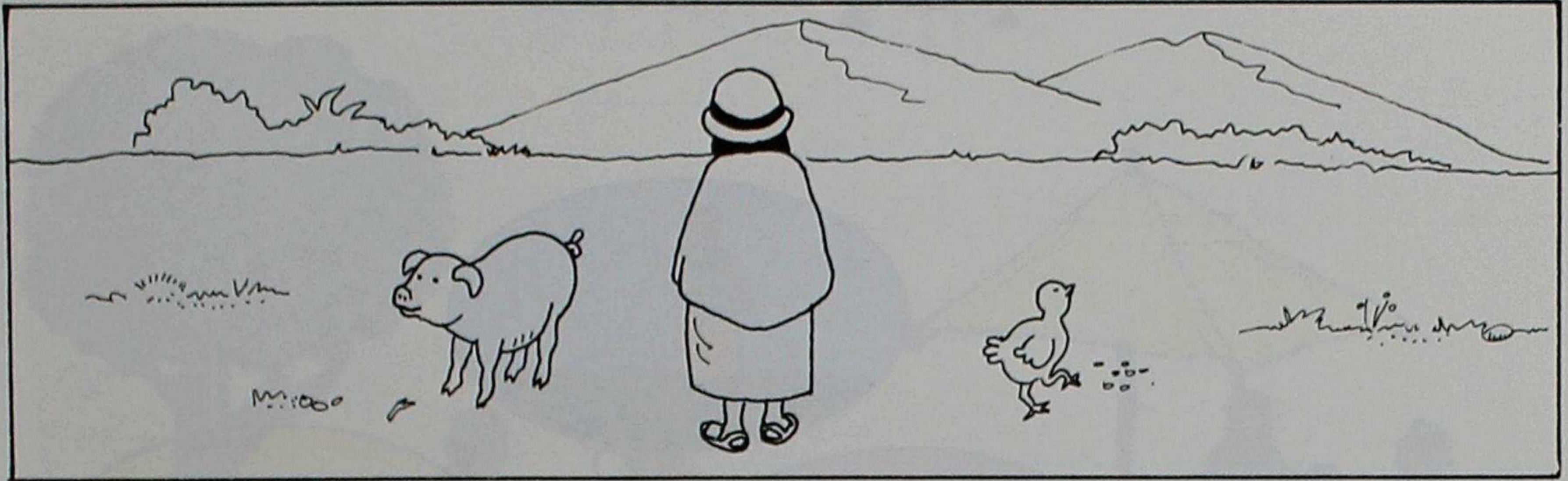
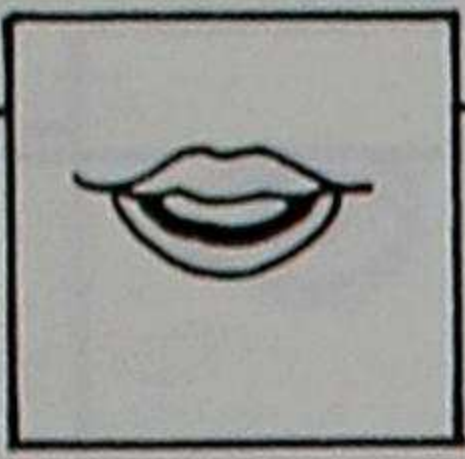

Cuchica lluqui maquiman saquirinmi.  
Chuchica alli maquiman saquirinmi.

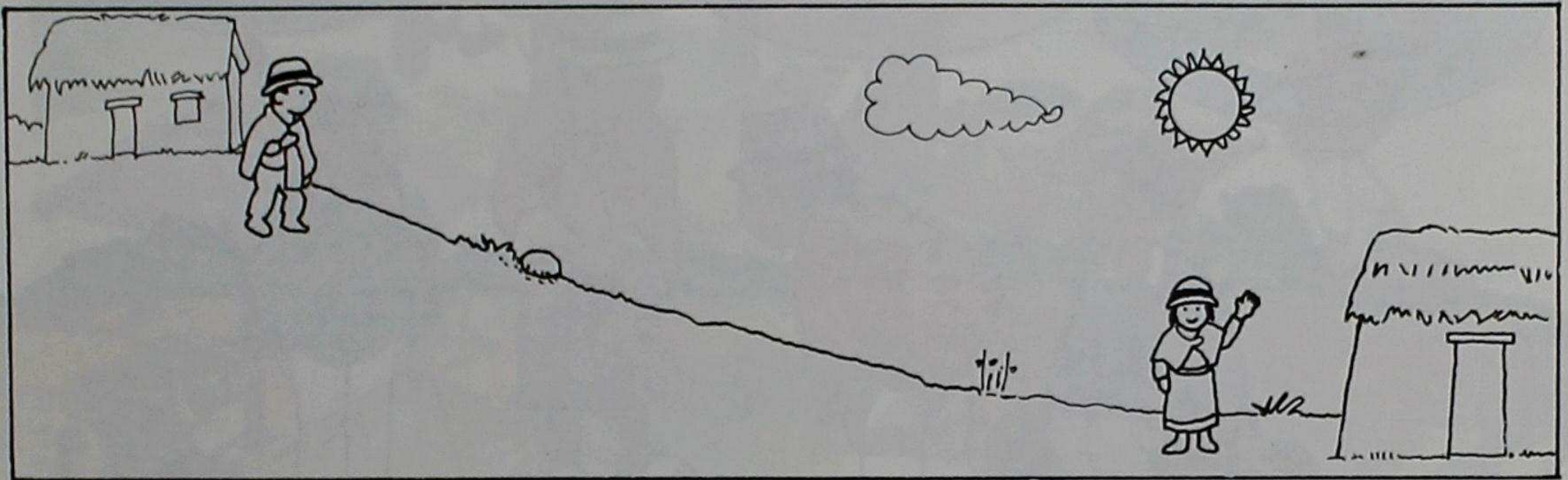

Taitaca jananpimi causan.  
Paipac ushushica uraipimi causan.

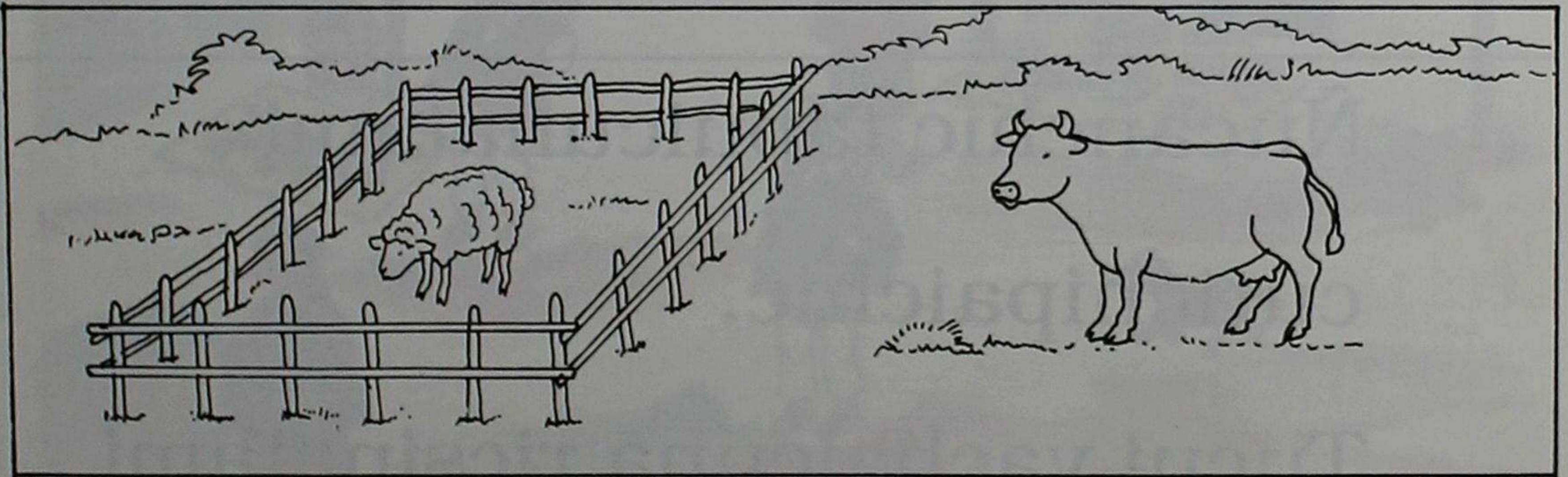

Llamaca quincha ucupimi can.  
Huacraca quincha canchapimi can.

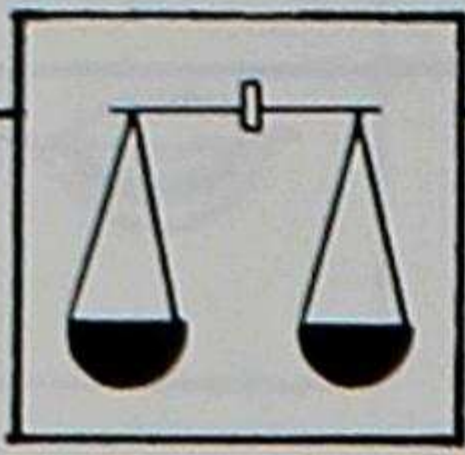

Ñucanchic tapuicunatami  
cutichipaichic.

Tucui yachaicuna ricsinatami  
munanchic.

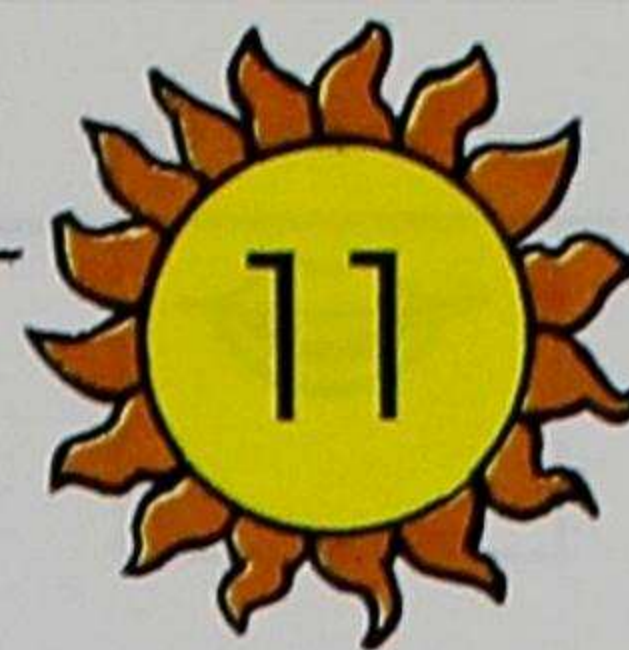
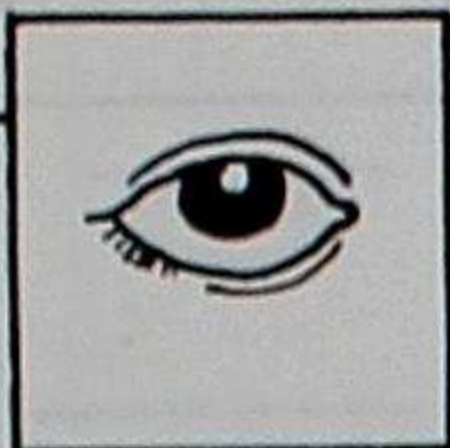

# Catuna panpa





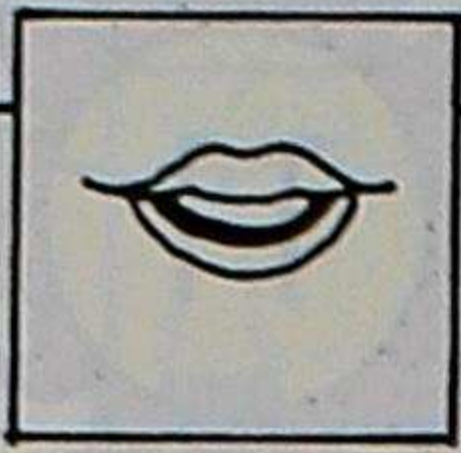

# Tupumanta

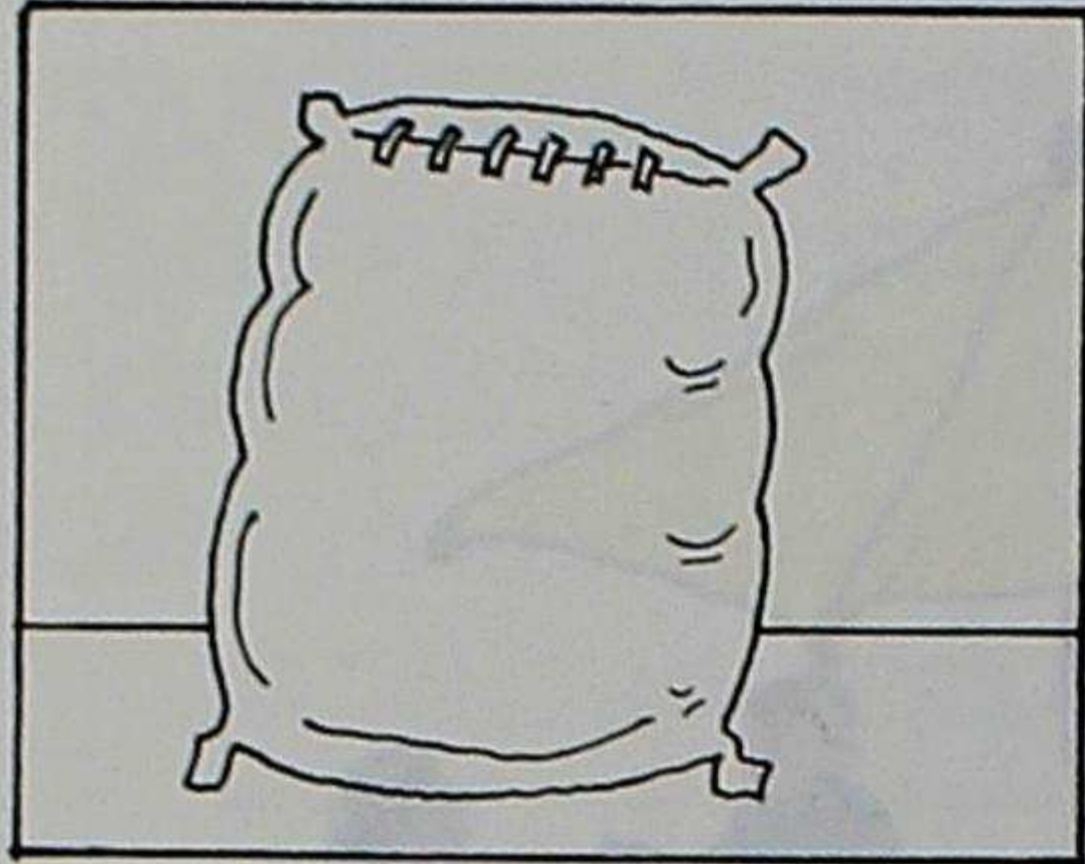

puccha



miclla



maqui

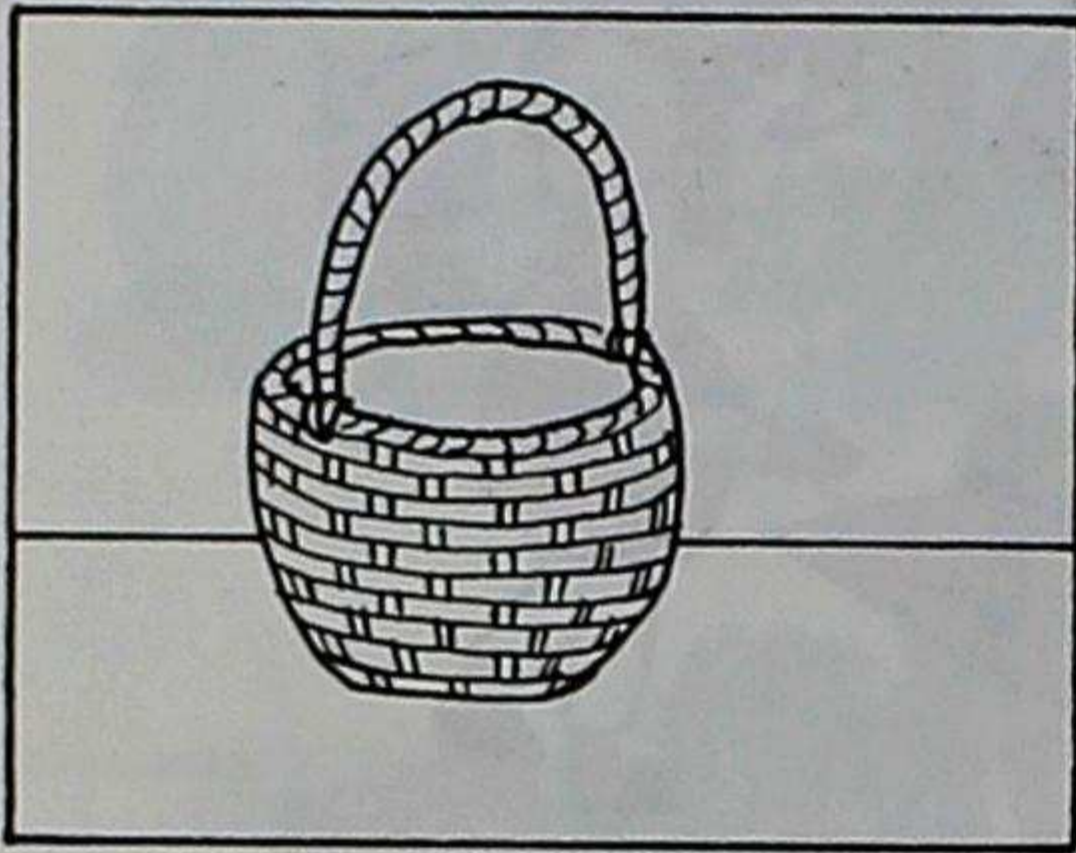

taza

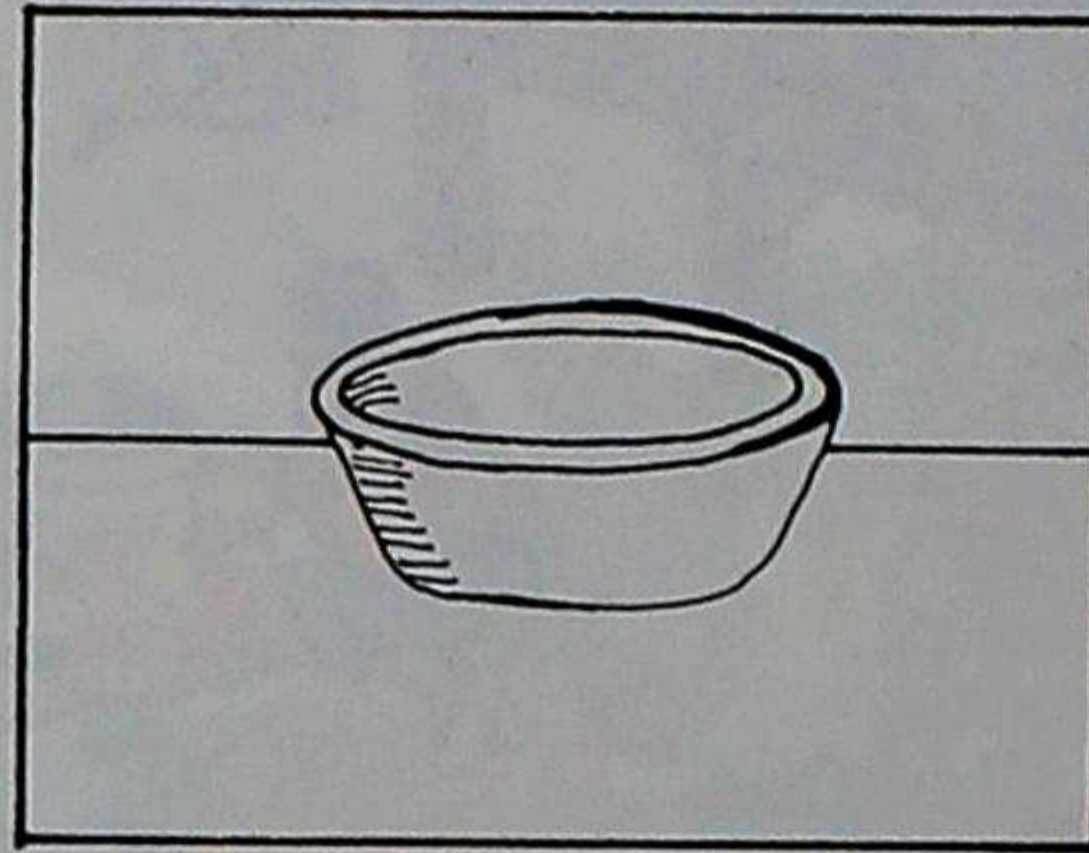

pucu

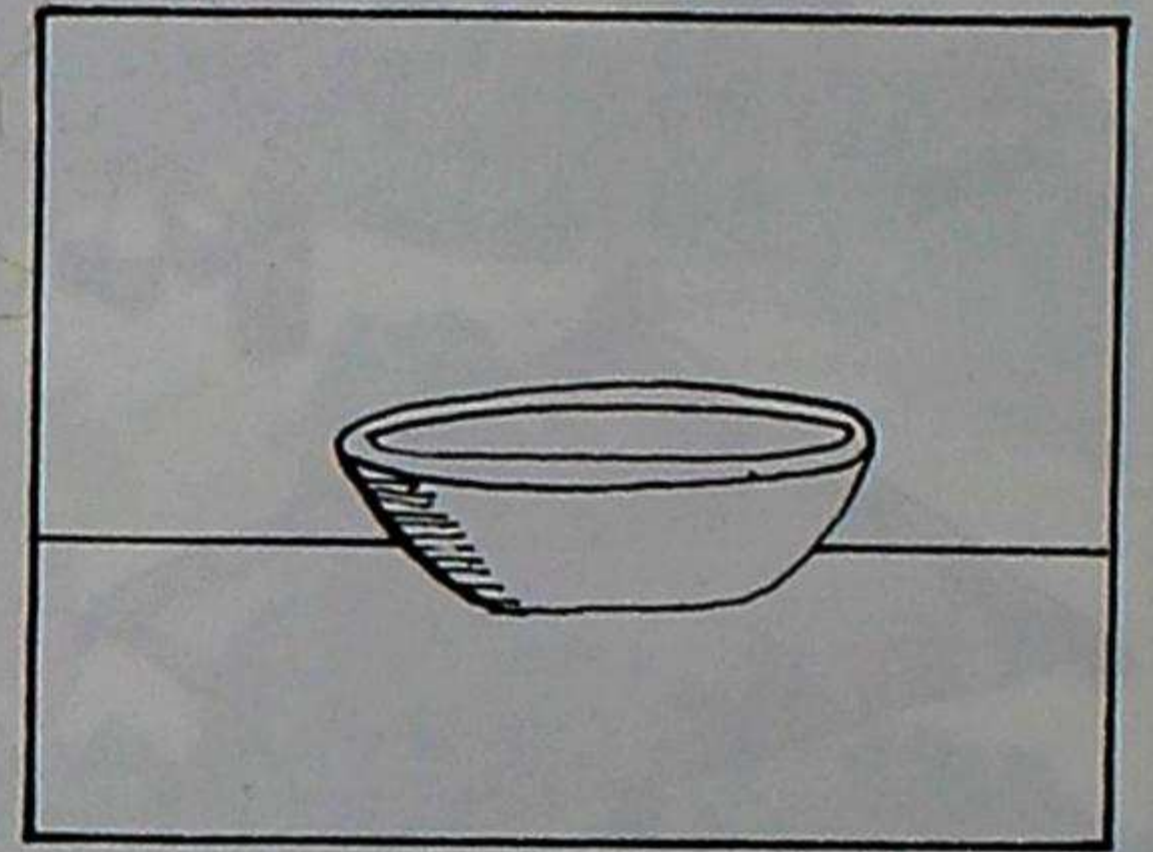

canu

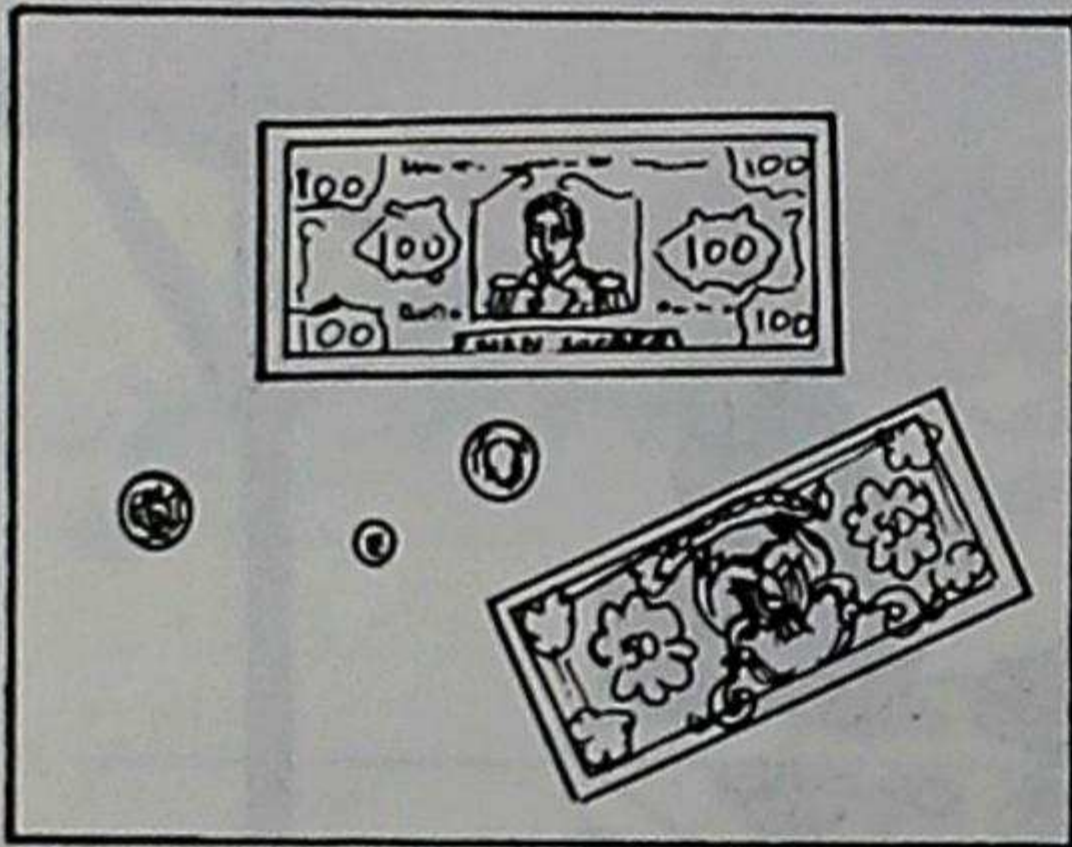

cullqui

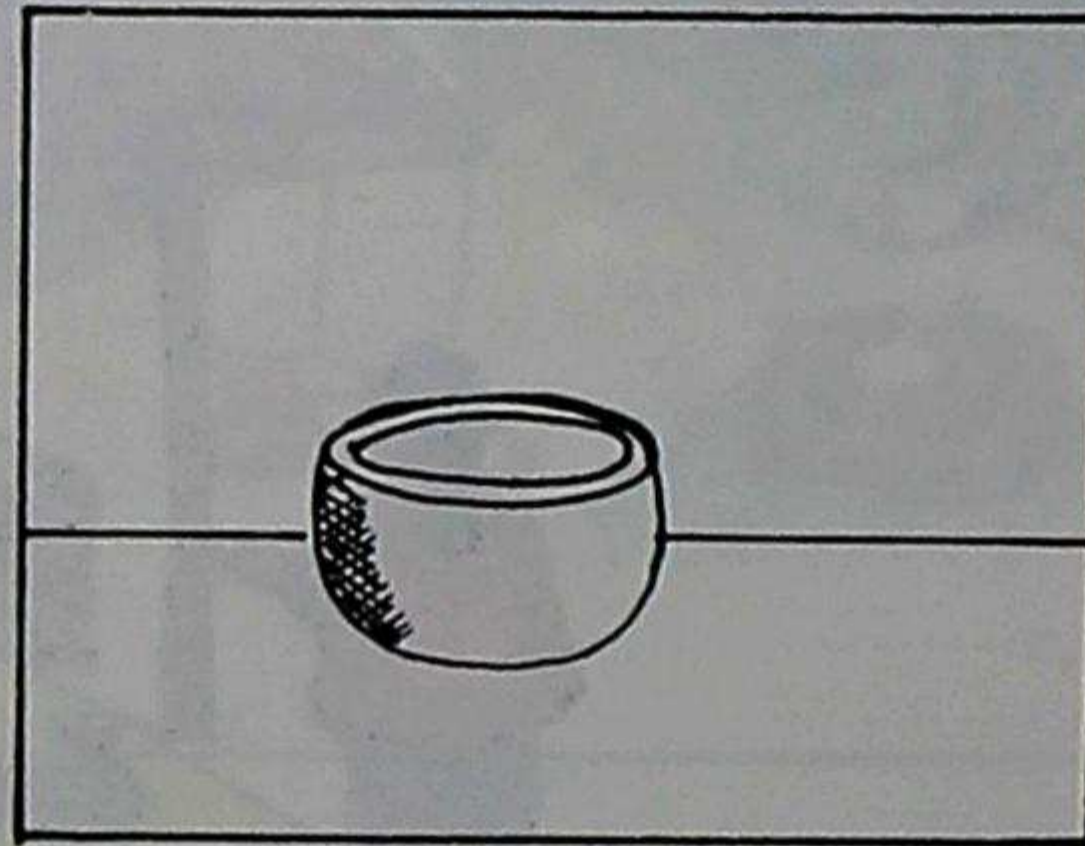

pilchi

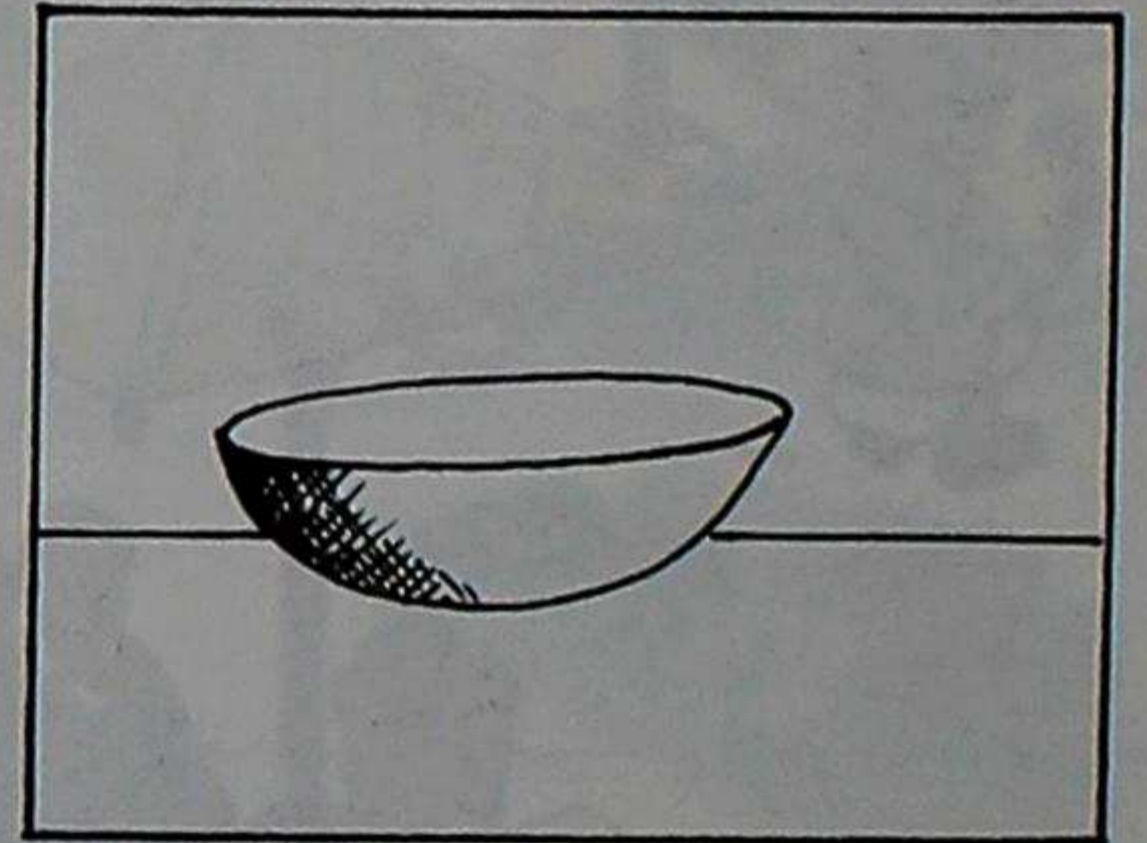

mati

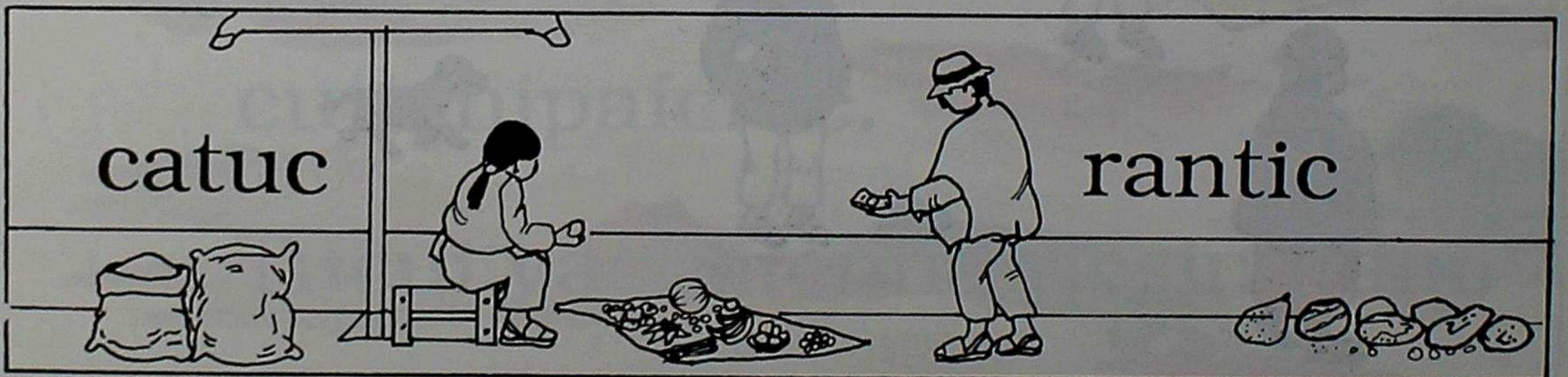

catuc

rantic

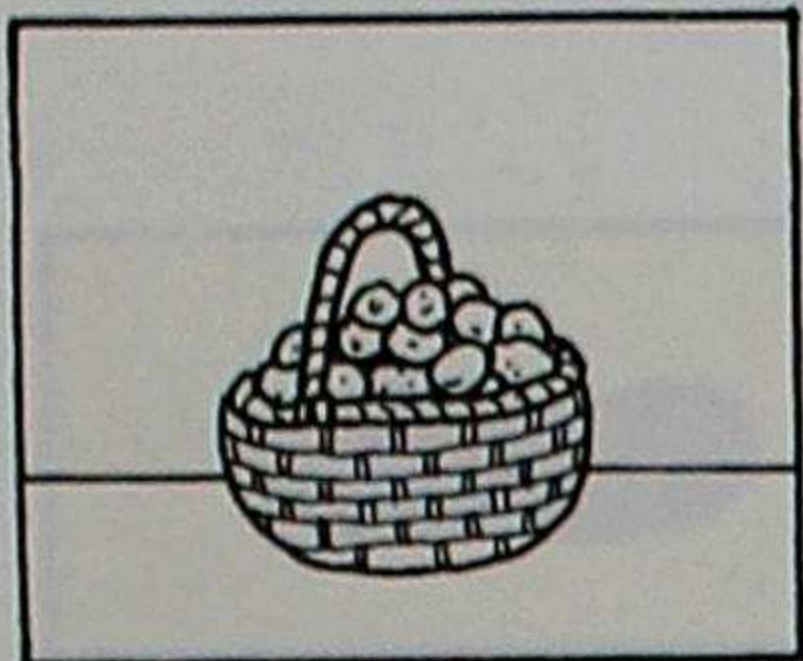
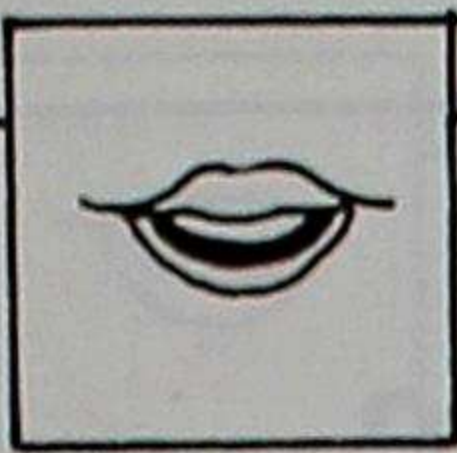

Tazaca papa juntami.

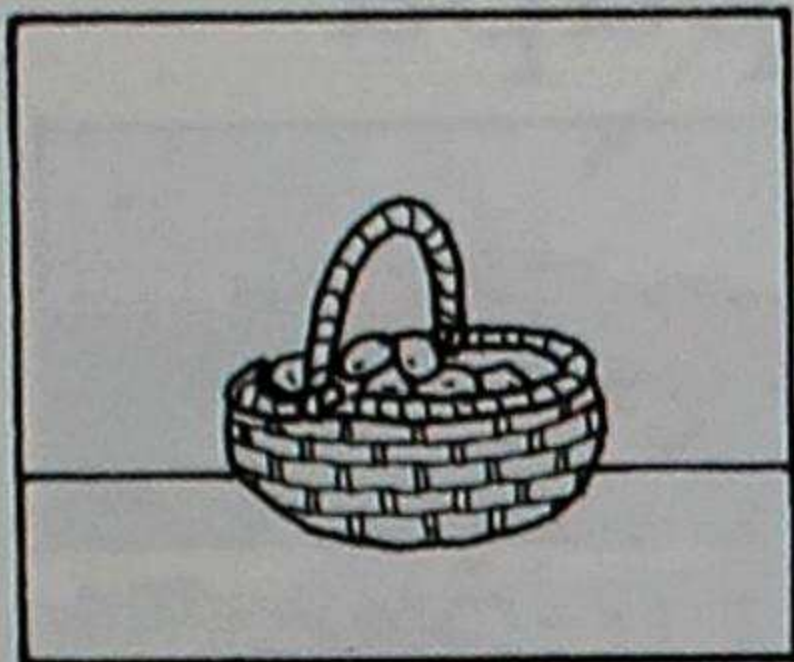

Tazaca asha papahuanmi.

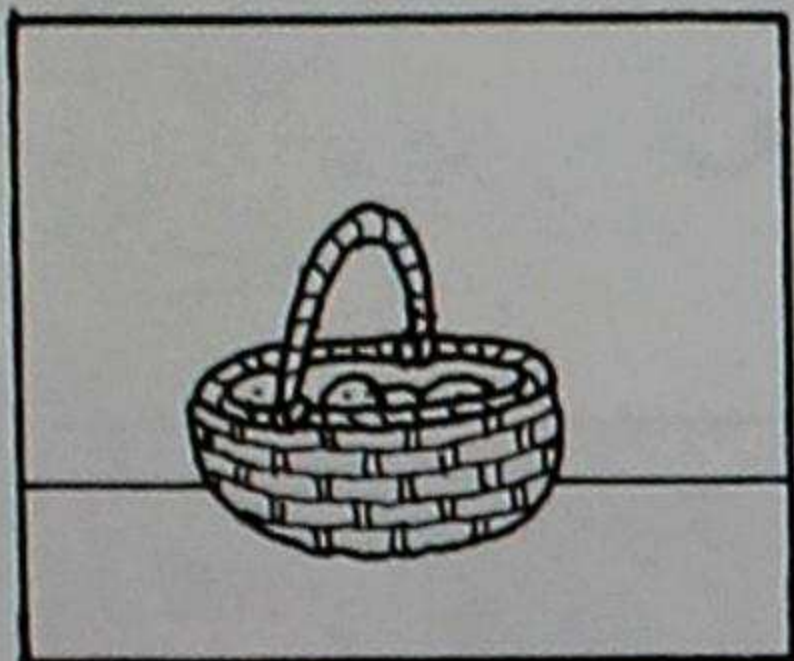

Tazaca chushacmi.

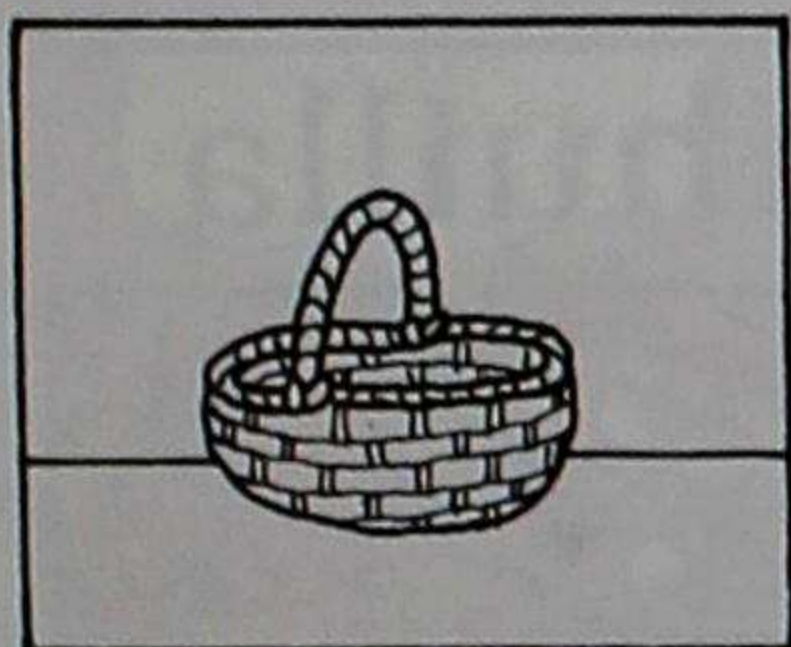

Tazaca papa illacmi.

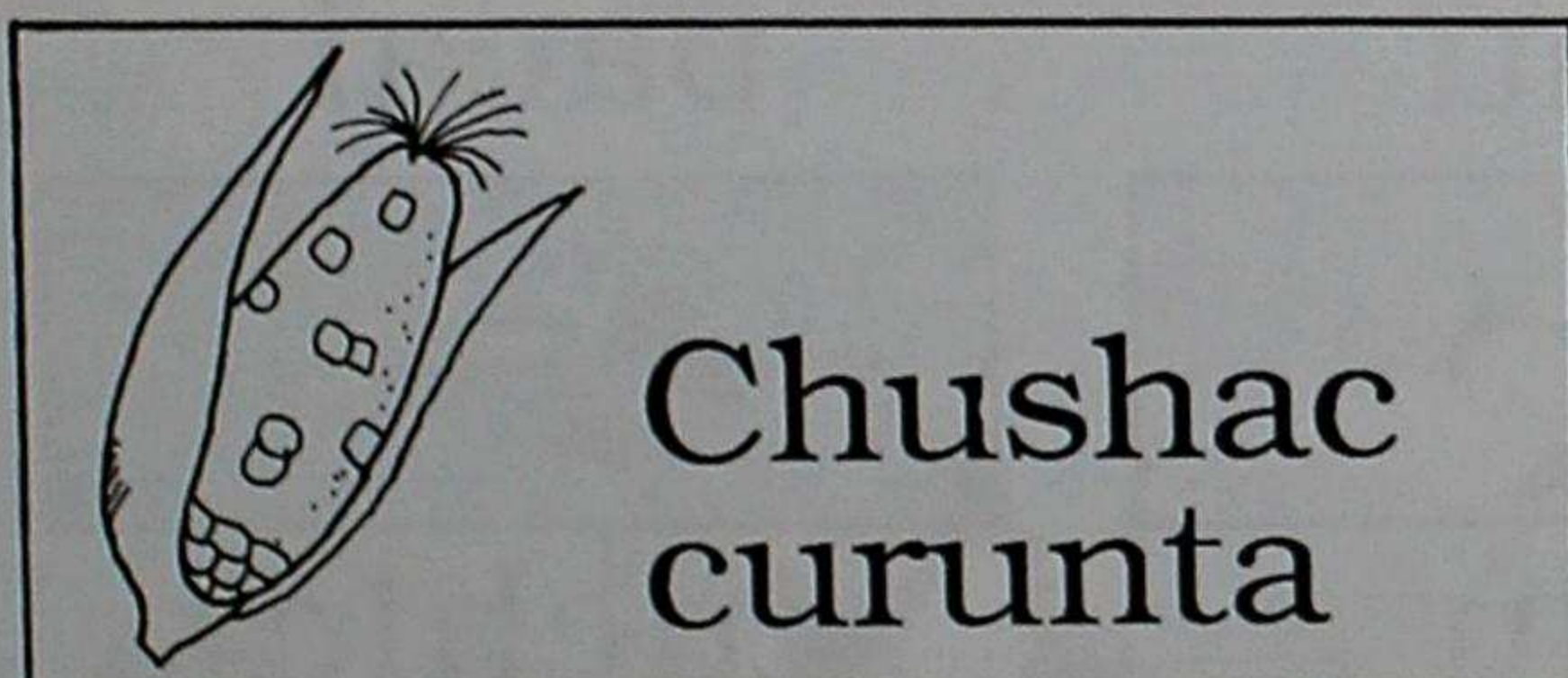

Chushac  
curunta

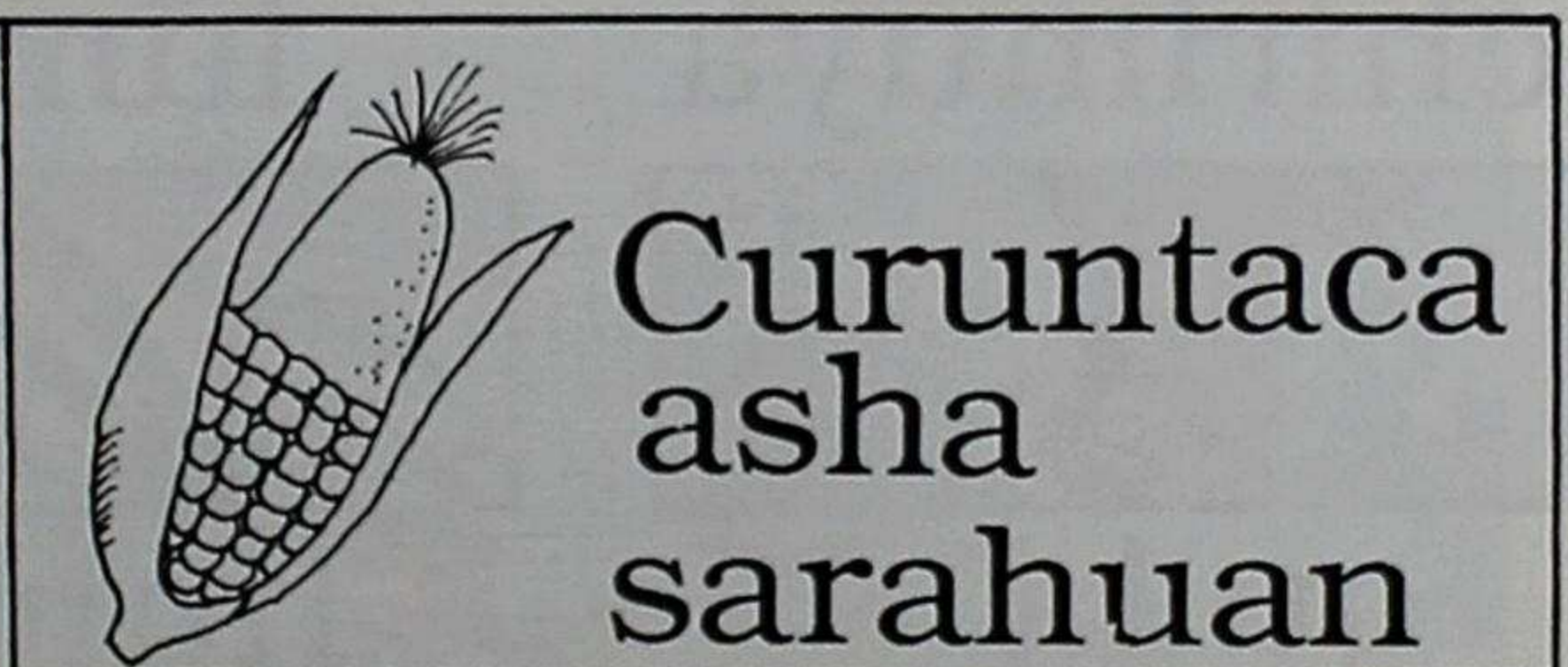

Curuntaca  
asha  
sarahuan

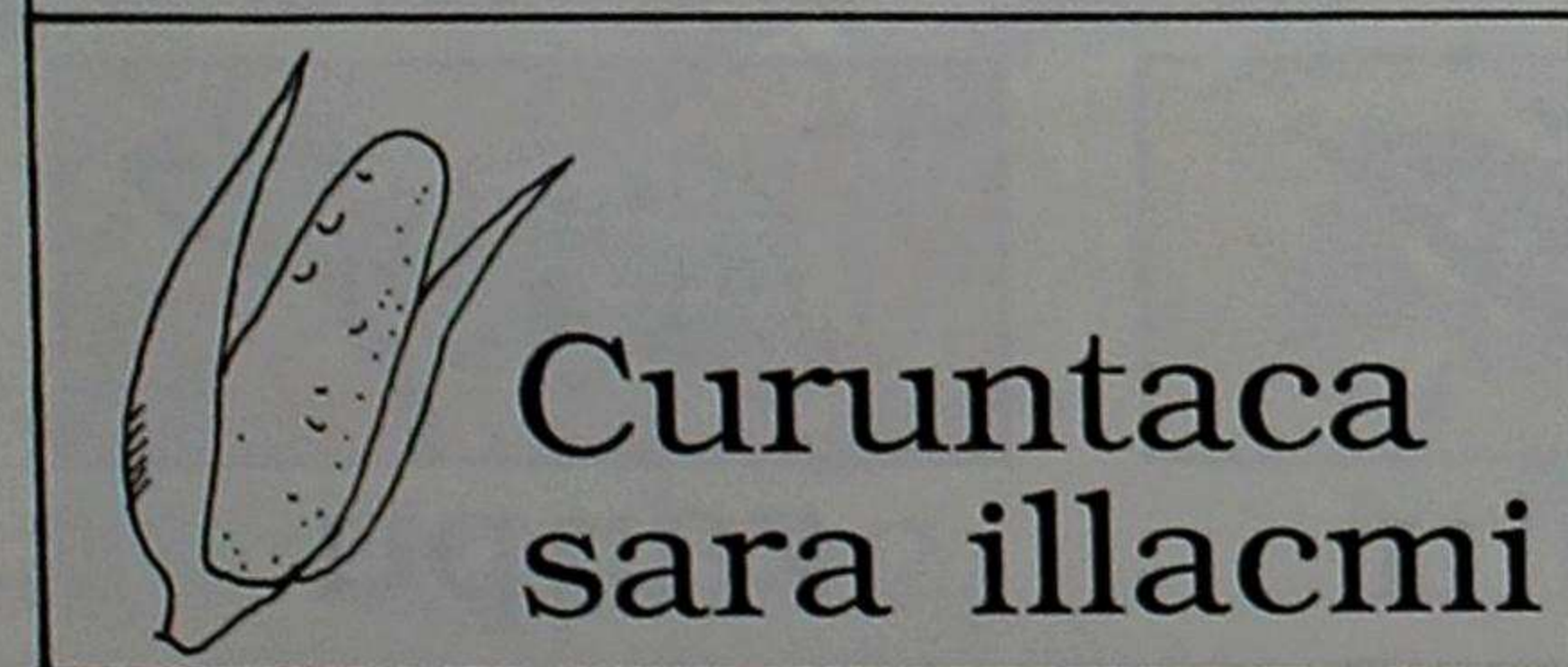

Curuntaca  
sara illacmi

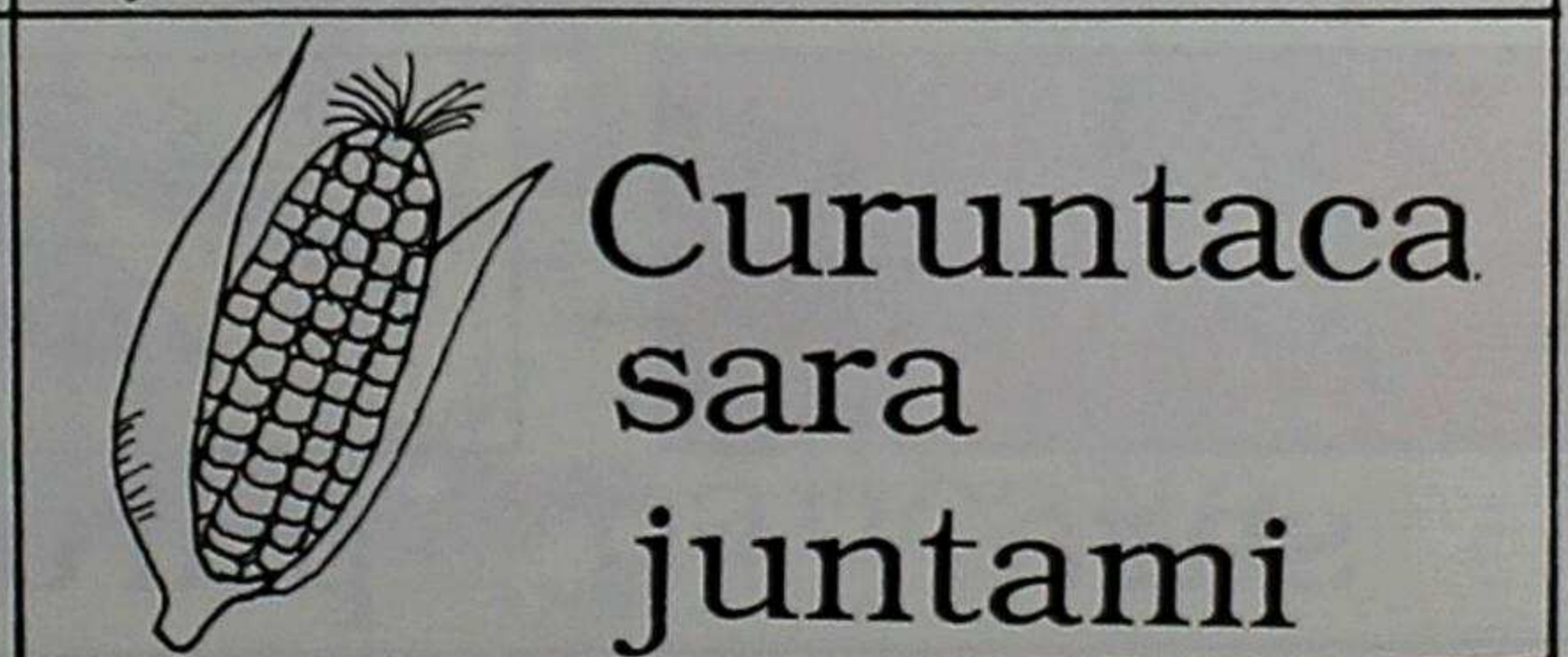

Curuntaca  
sara  
juntami

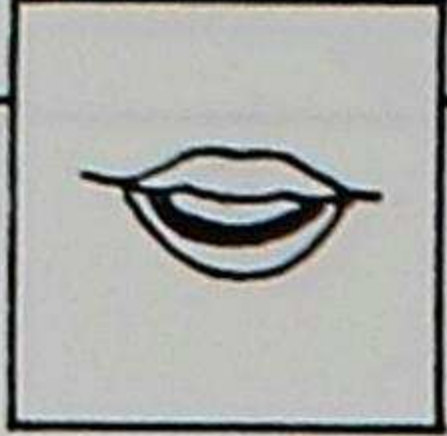

## Jahua allpapi pucuc murucunamanta

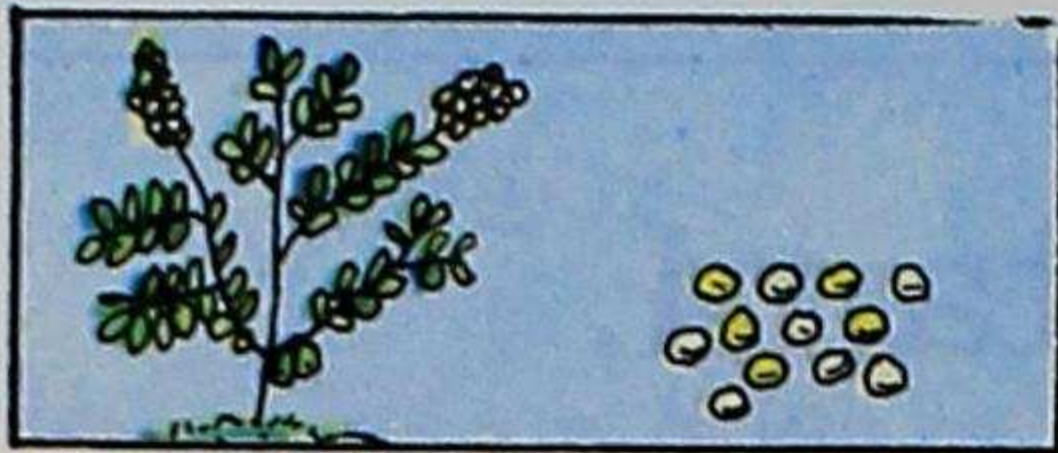

tauri

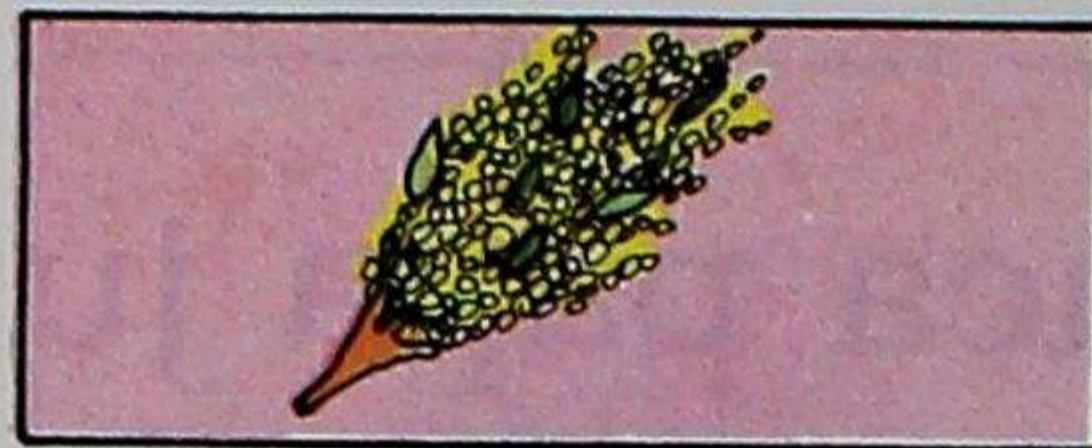

quinua

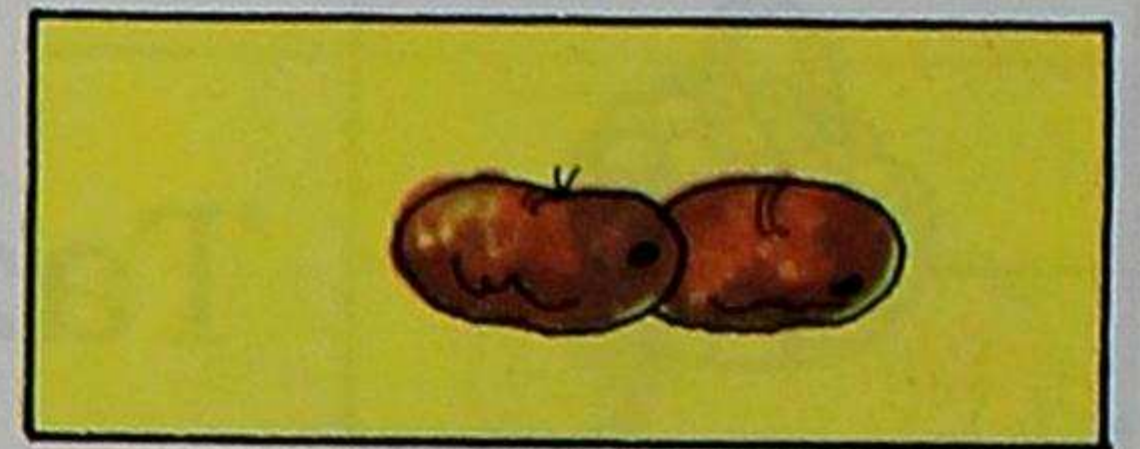

papa

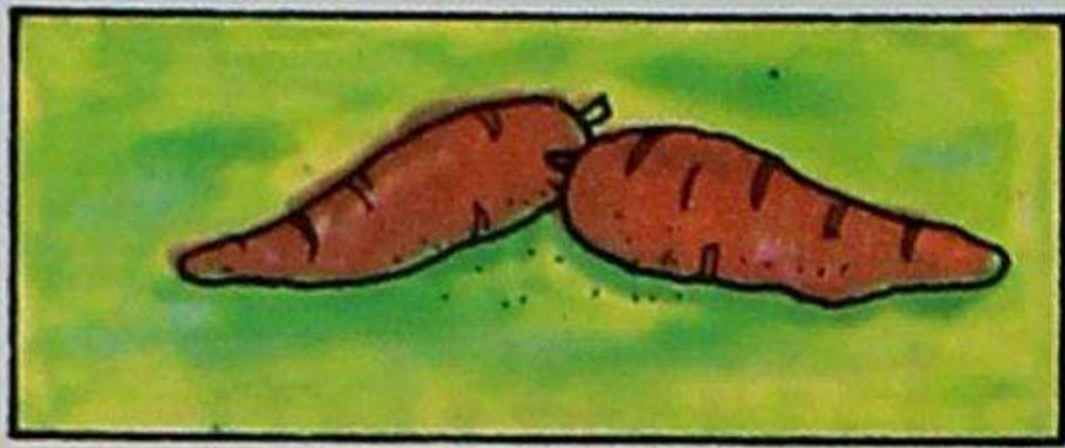

mashua

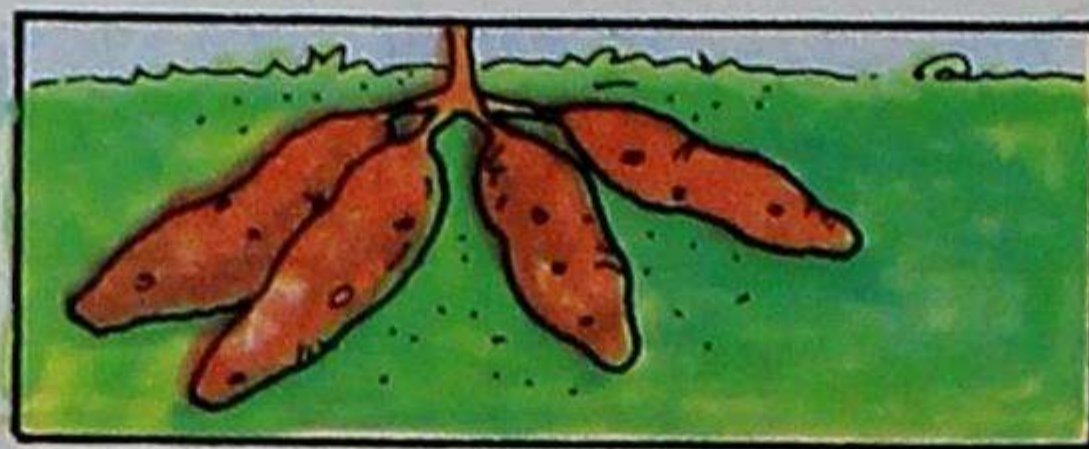

jicama

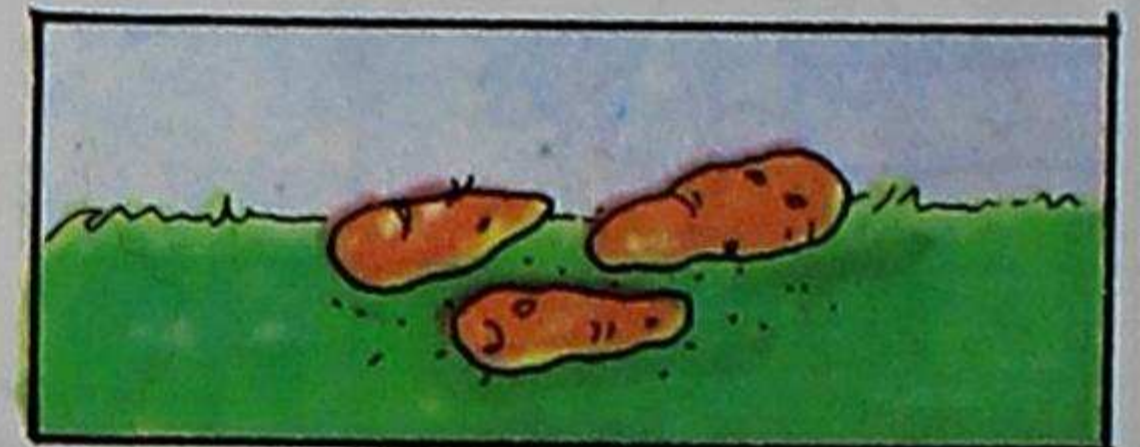

uca

## Yunca allpapi pucuc murucunamanta

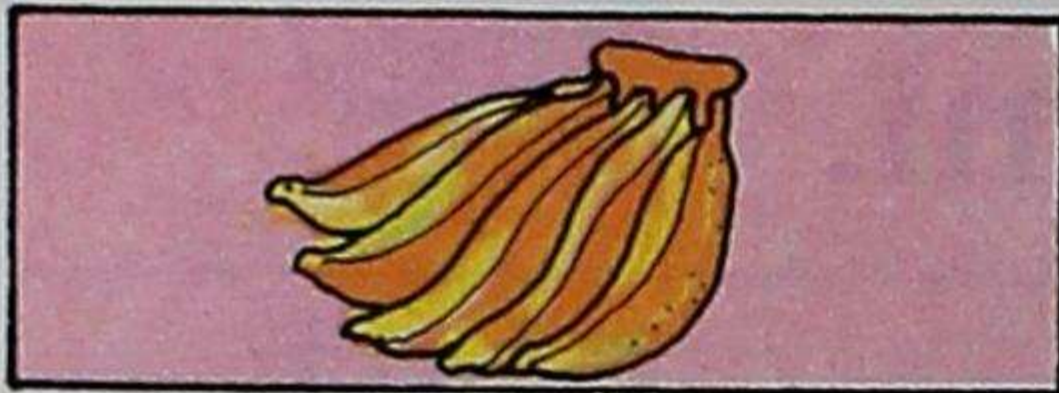

palanta

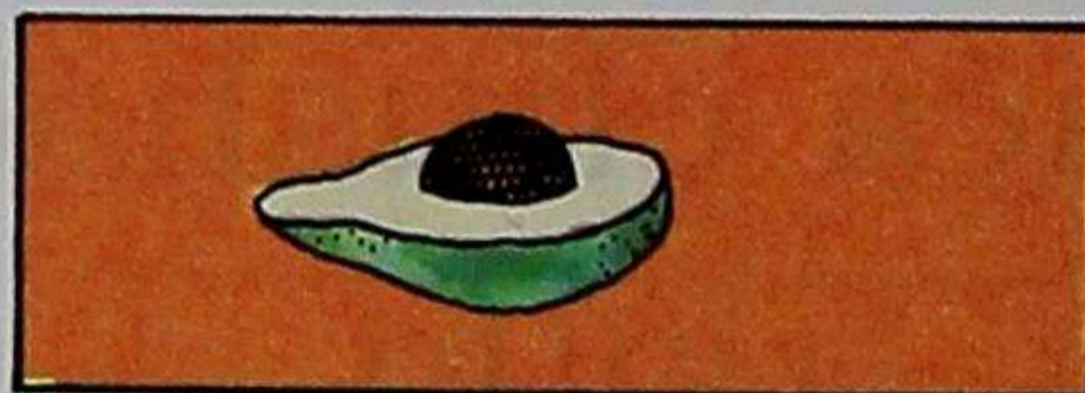

palta

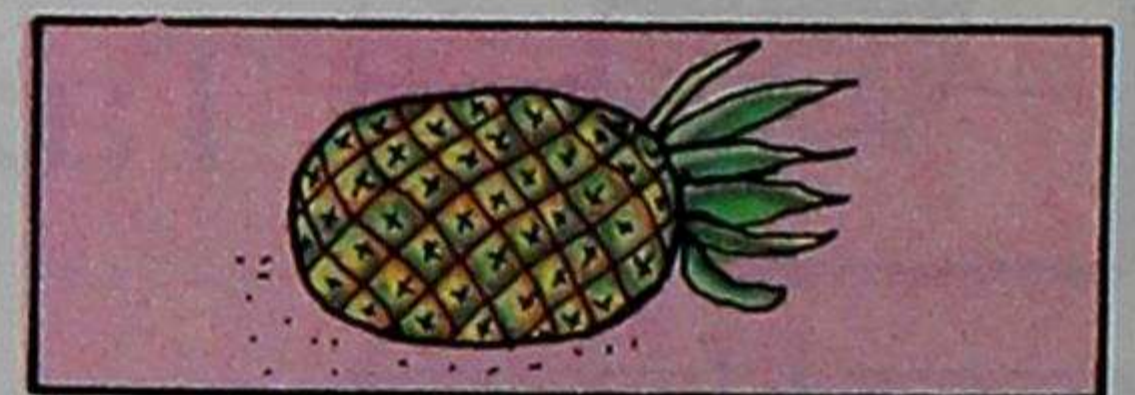

chihuilla

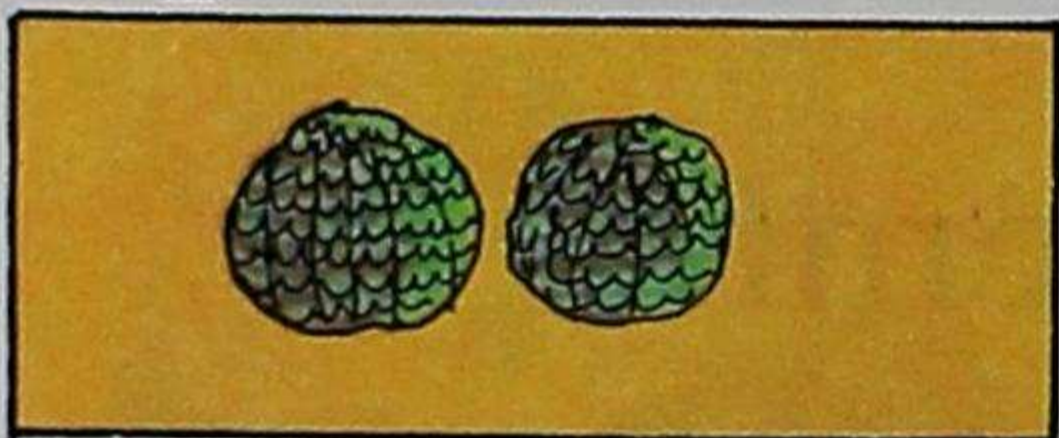

chirimuya

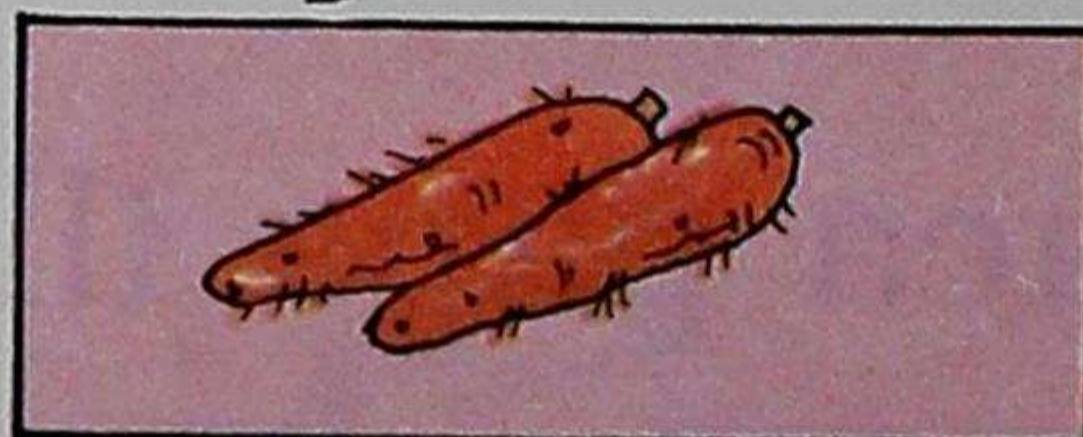

lumu

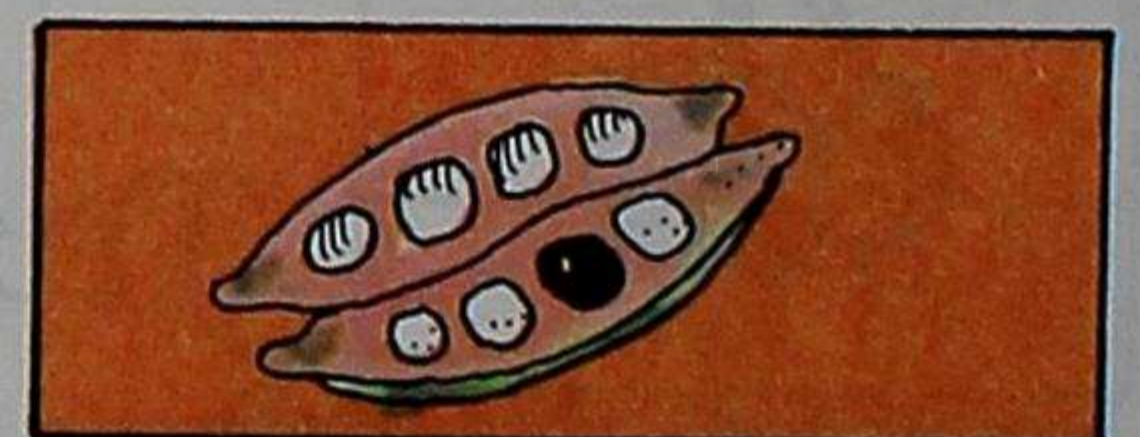

pacai

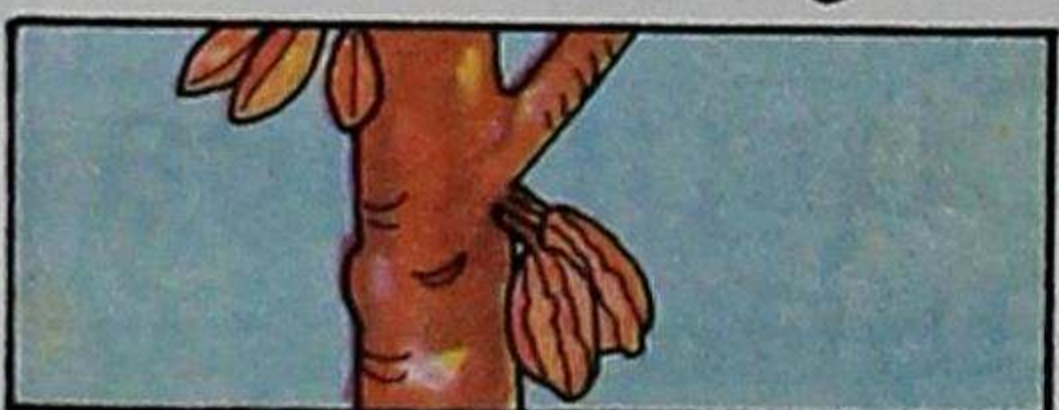

quila

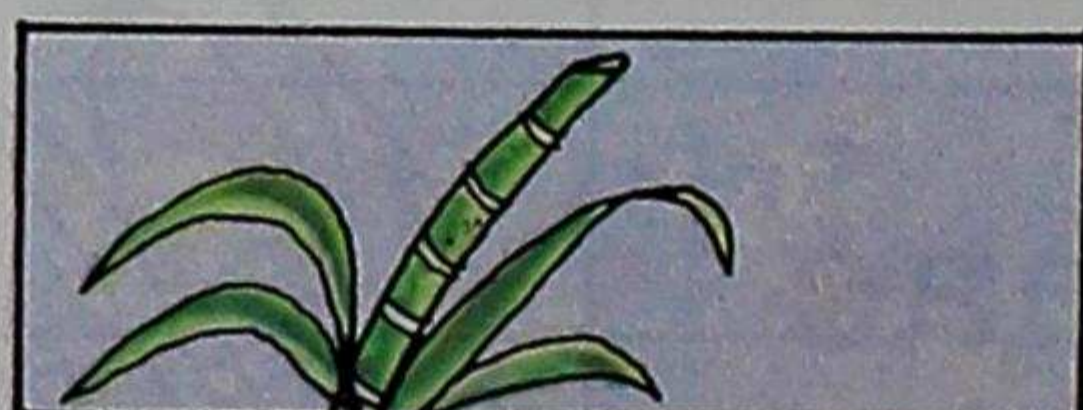

huiru

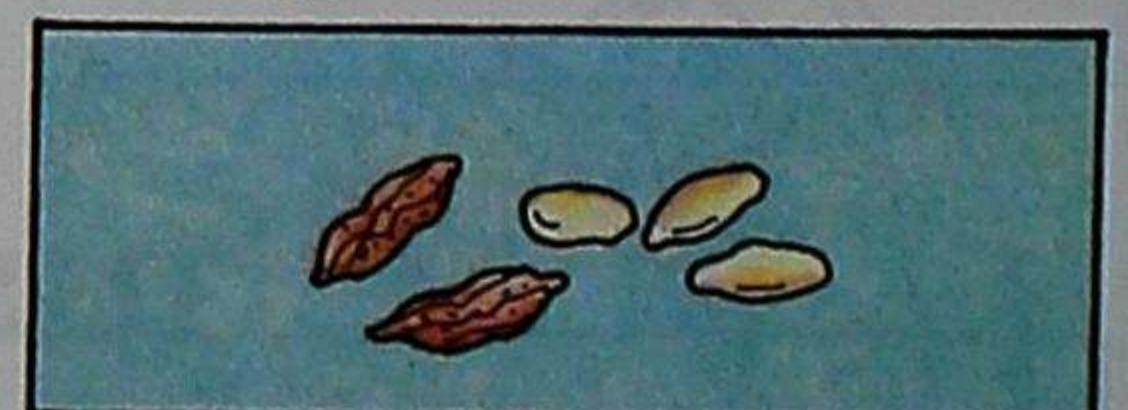

inchic

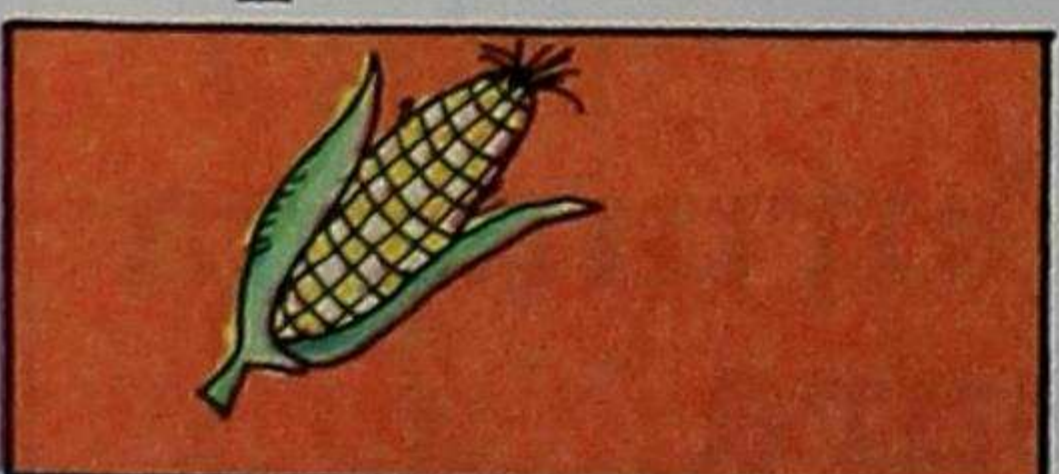

sara

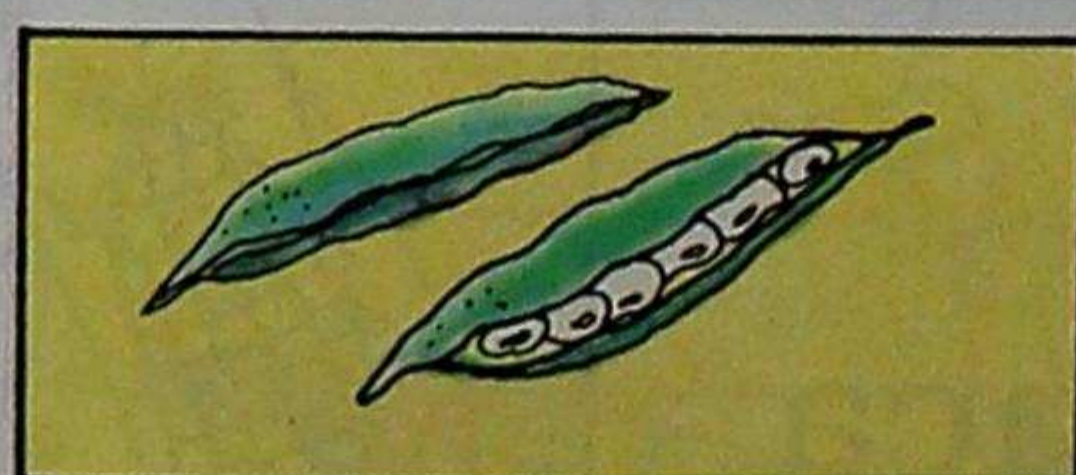



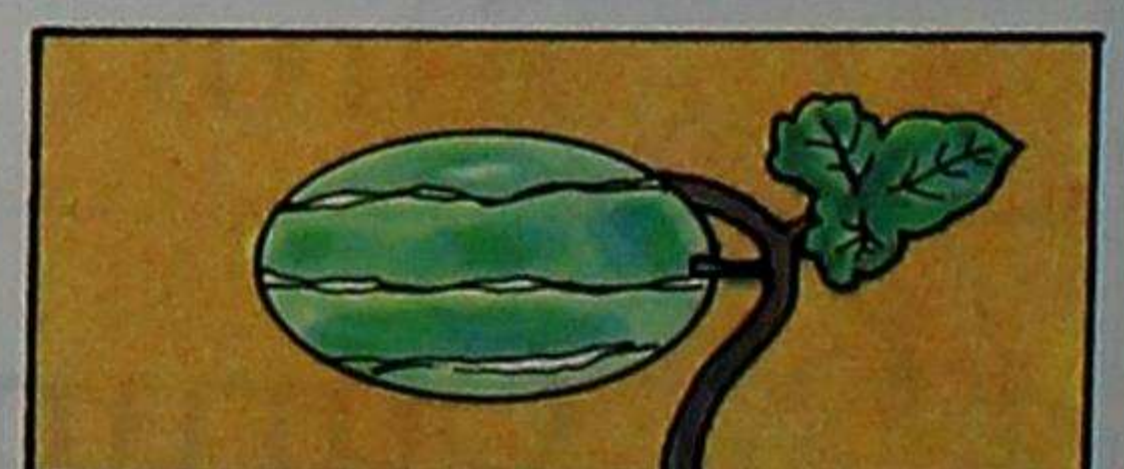

purutu

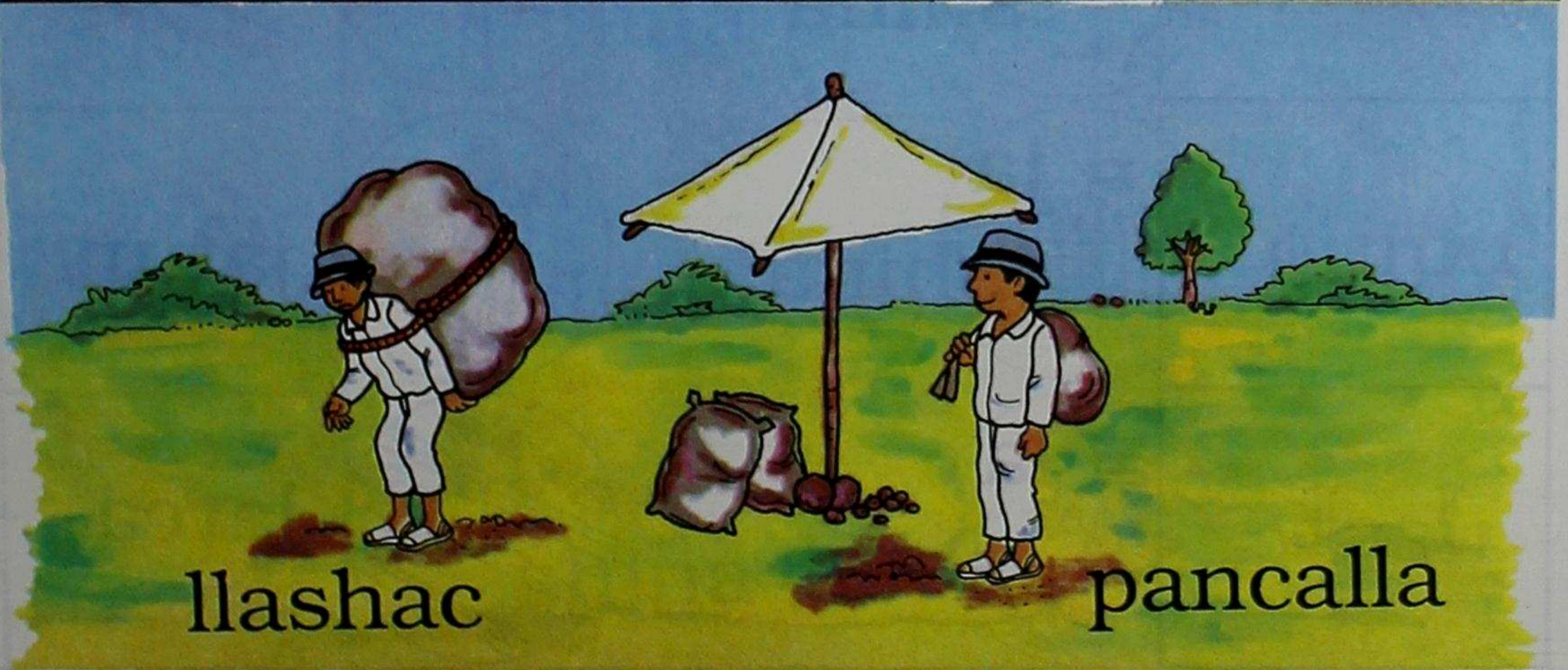
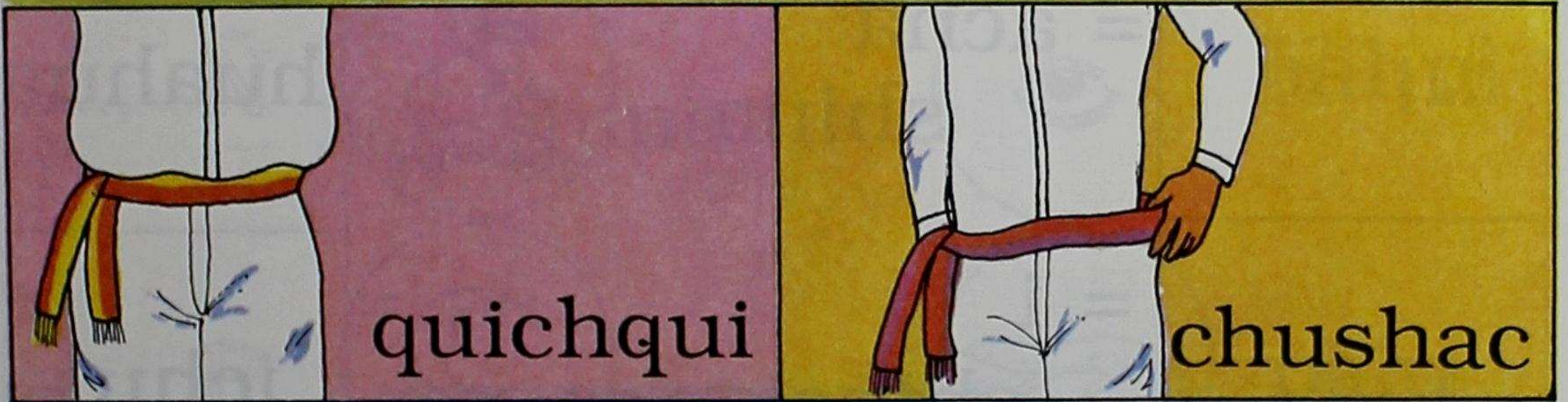
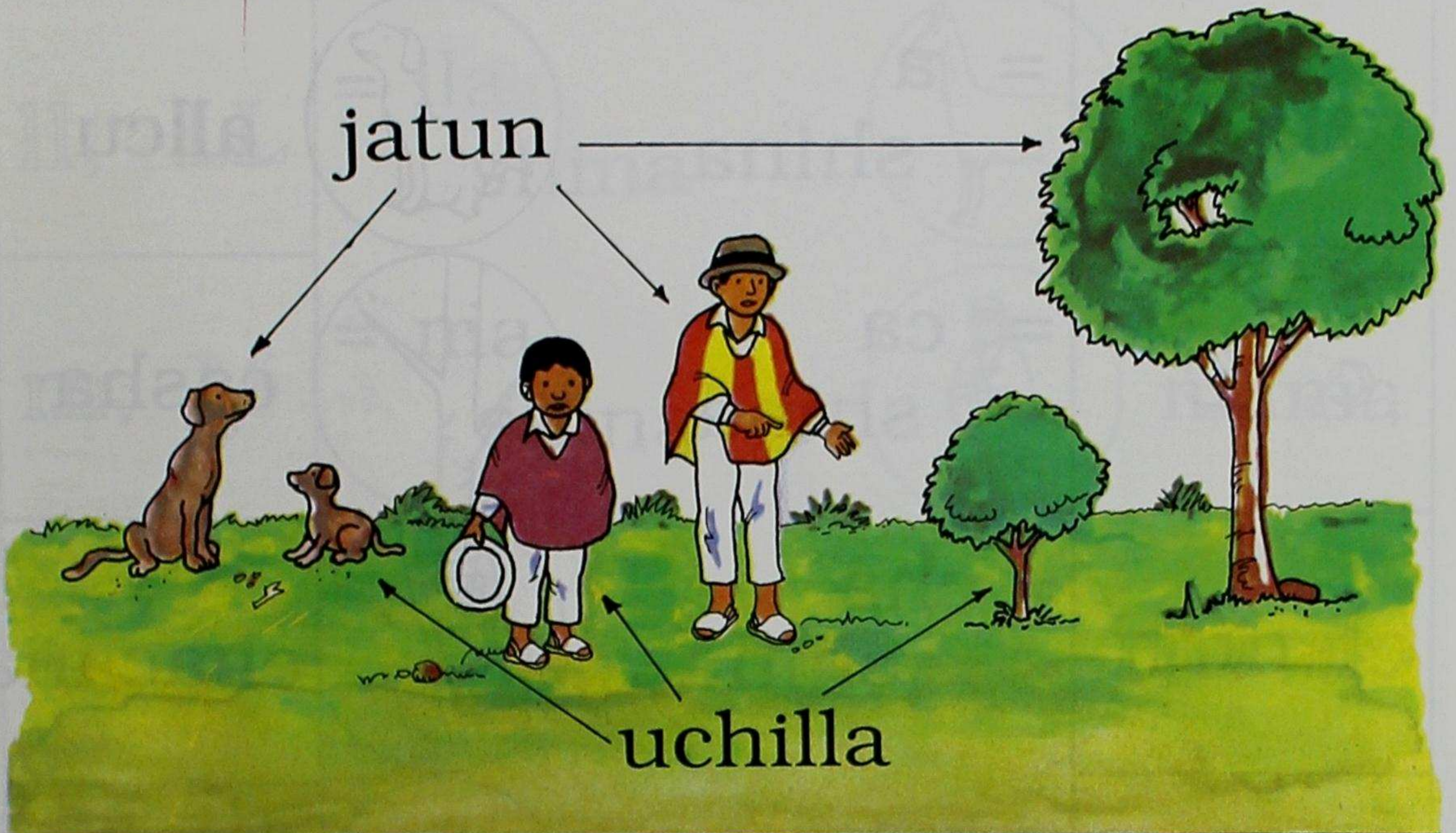
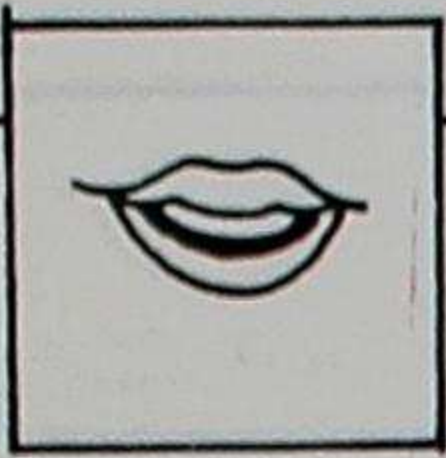

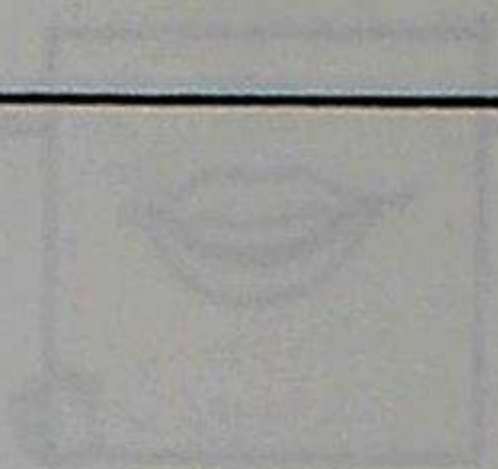
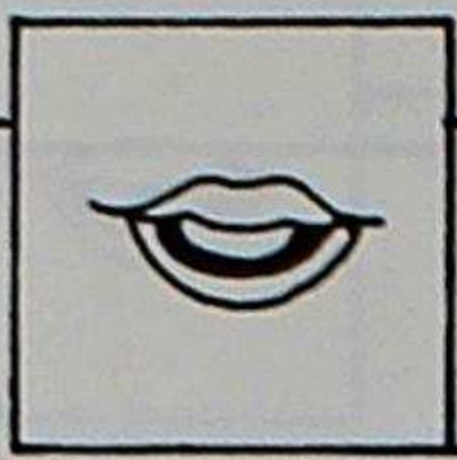

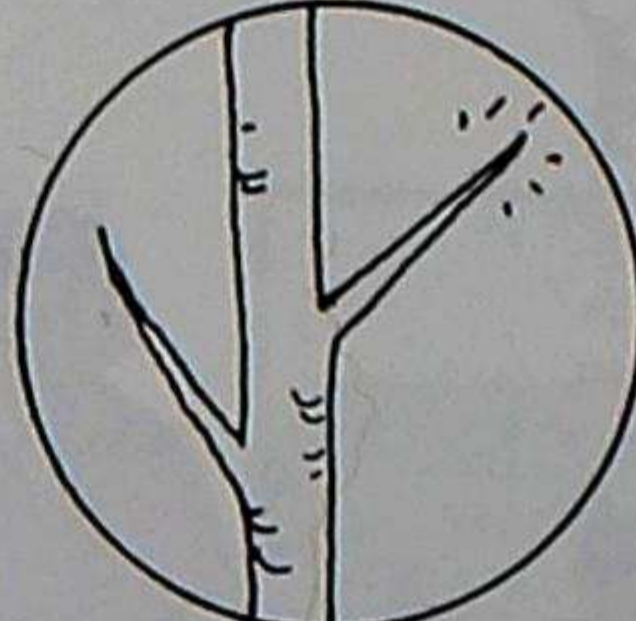
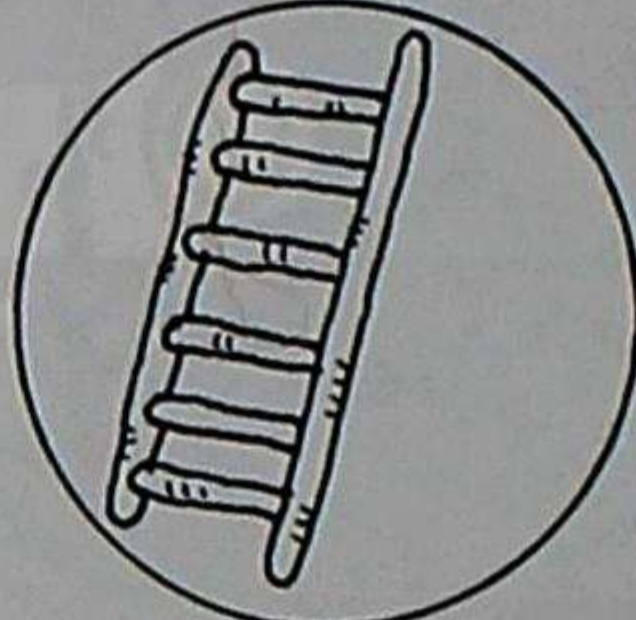

zanpu

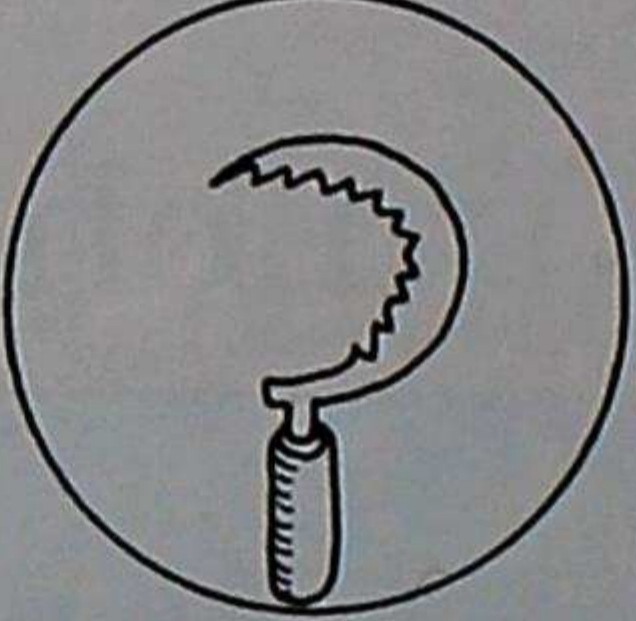
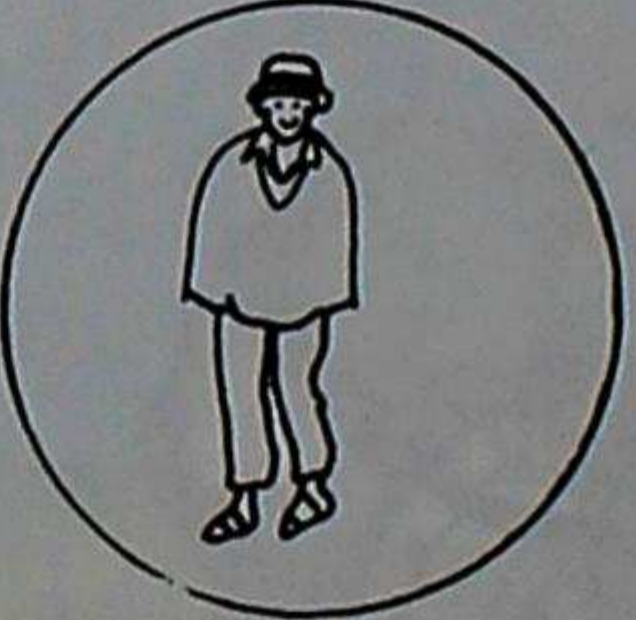
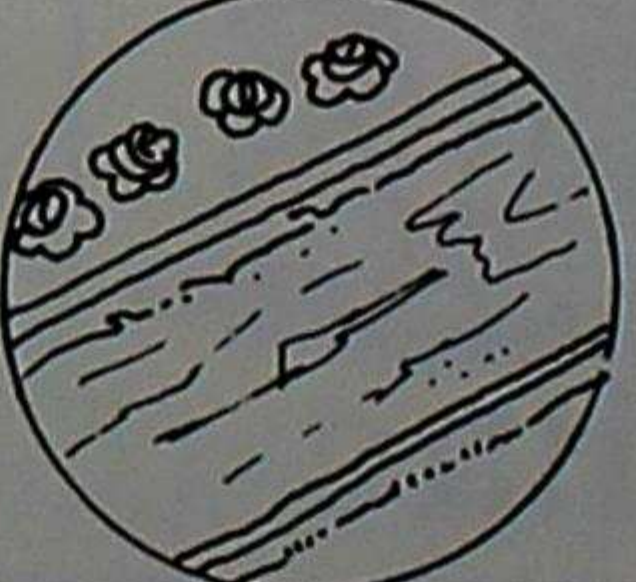

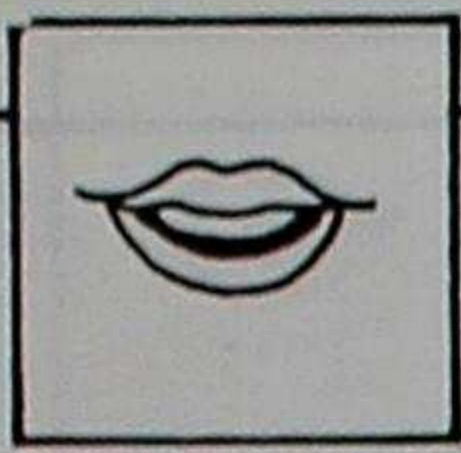

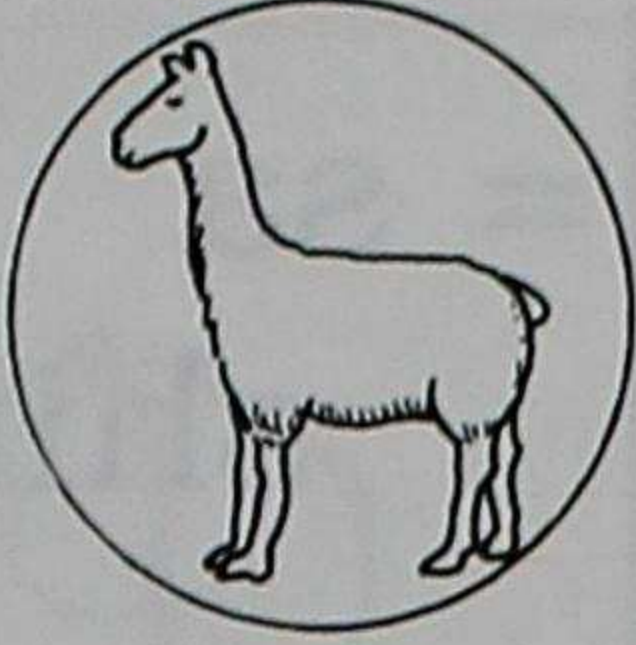

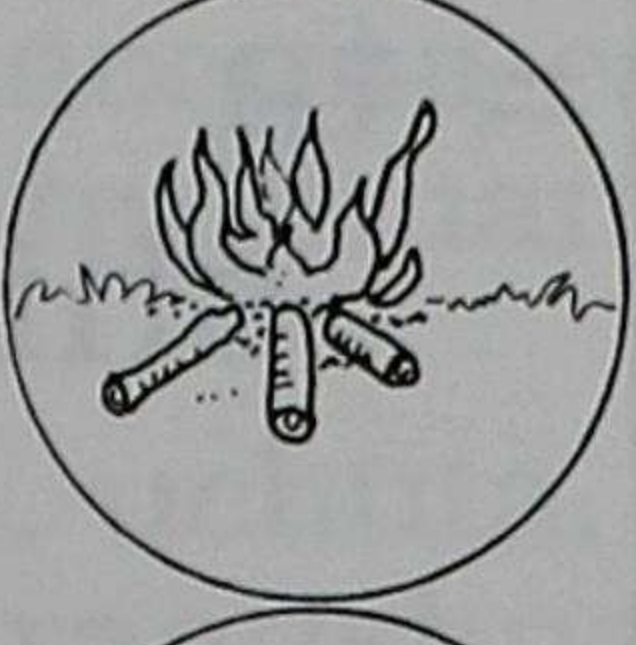
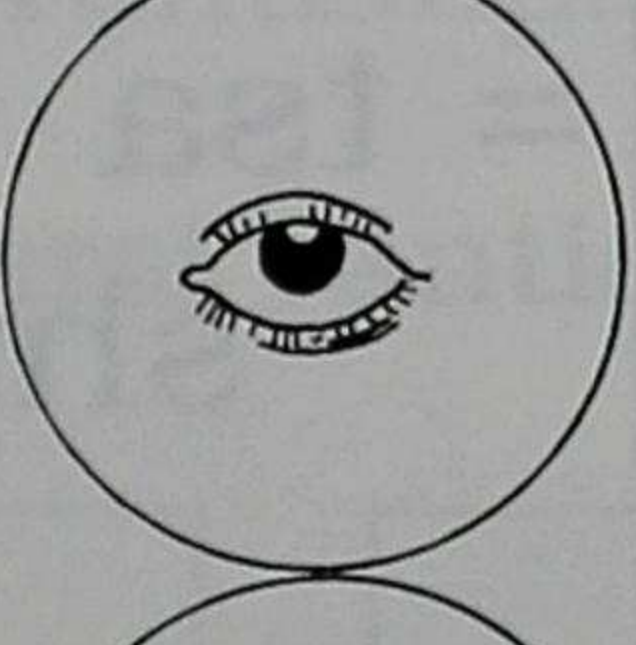

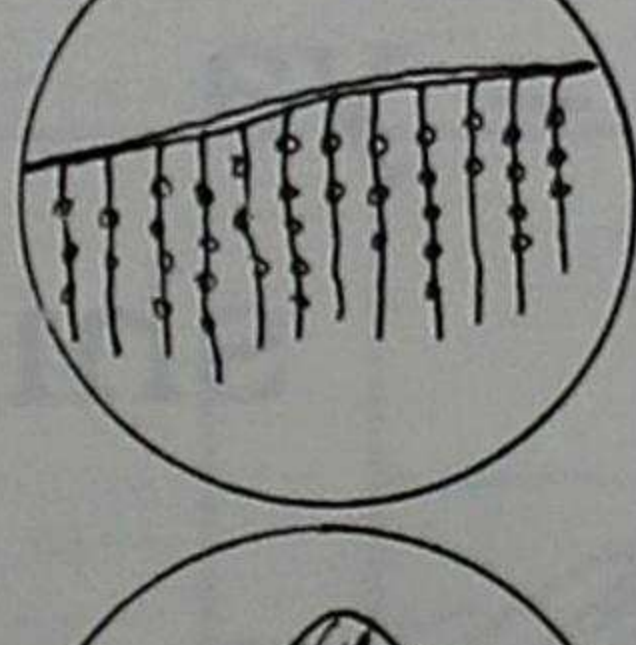
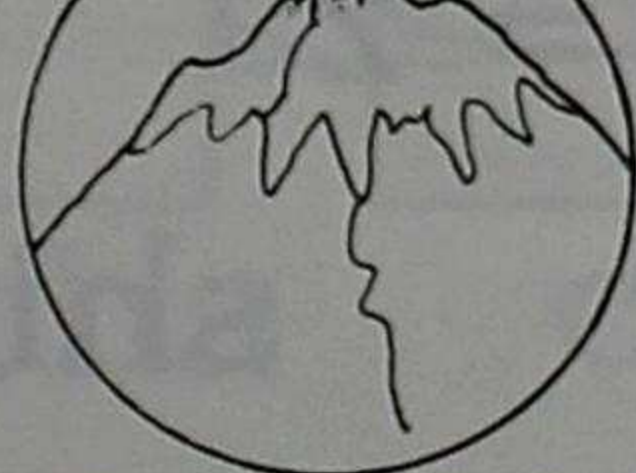

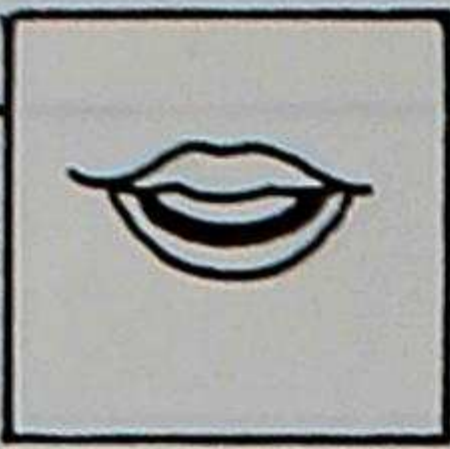
a, A	= a shina		allcu
c, C	= ca shina		cashu
ch, Ch	= cha shina		chacana
h, H	= acha shina		huahua
i, I	= i shina		ichu
j, J	= ja shina		jatun
l, L	= la shina		larca

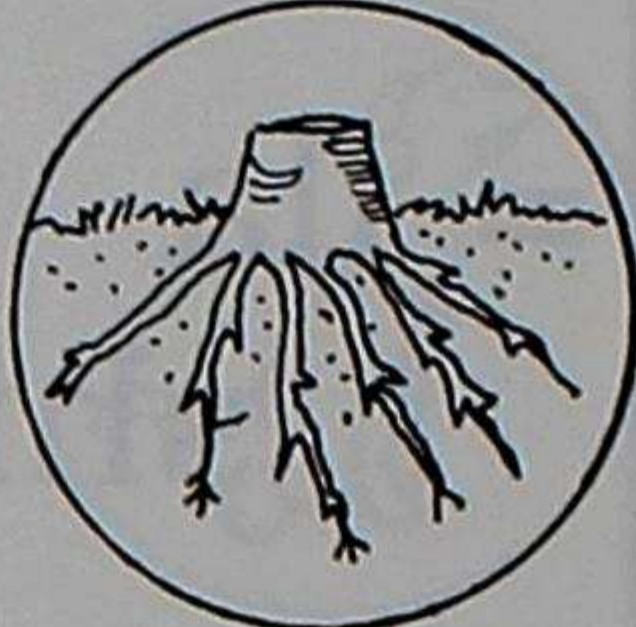

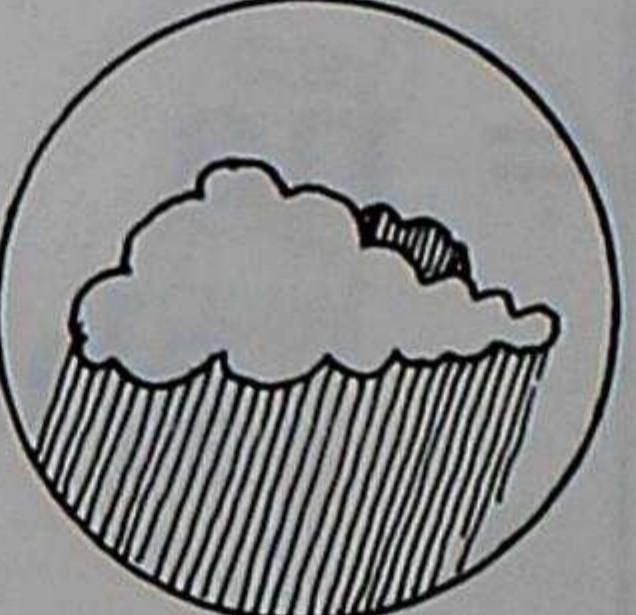
ll, LL	= lla shina		llama
m, M	= ma shina		mama
n, N	= na shina		nina
ñ, Ñ	= ña shina		ñahui
p, P	= pa shina		palu
q, Q	= qui shina		quipu
r, R	= ra shina		rasu



s, S	= sa shina		sapi
sh, Sh	= sha shina		shañu
t, T	= ta shina		tamia
ts, Ts	= tsa shina		tsahuar
u, U	= u shina		urpi
y, Y	= ya shina		yacu
z, Z	= za shina		zupu

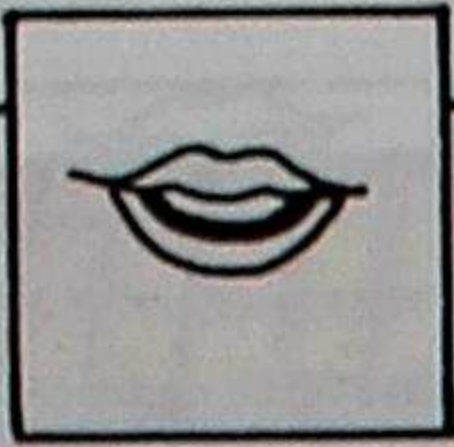

## Mindalamanta

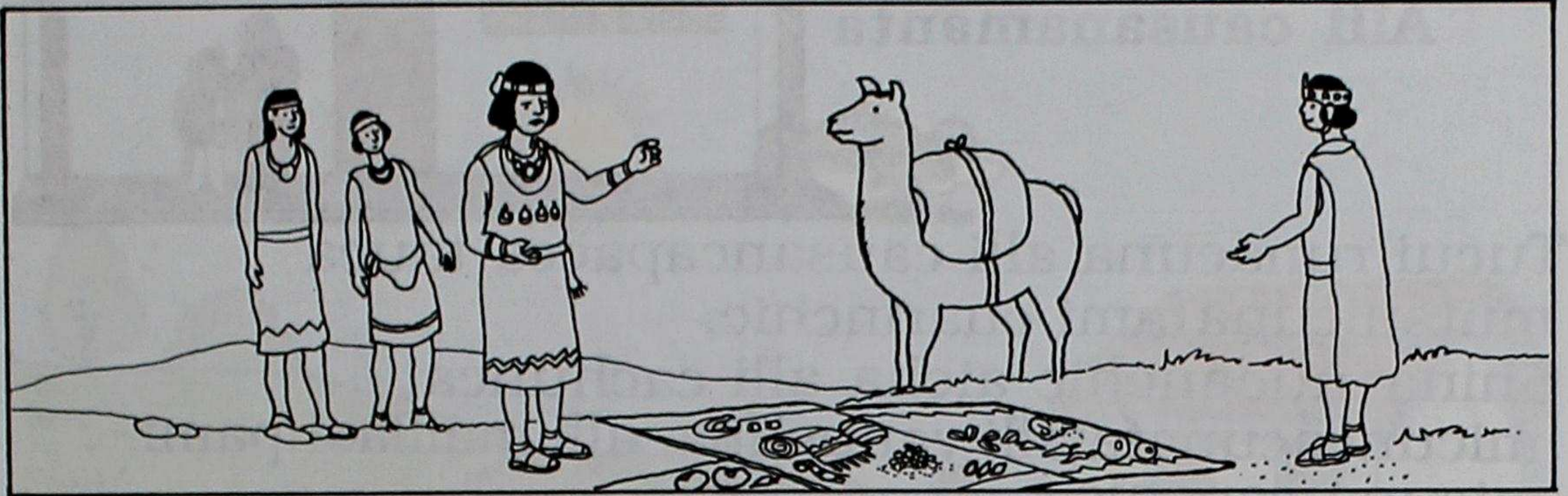

Ñaupá pachamanta aillu runacunaca shucta shuctahuan rantishpalla causaccuna cashca. Chai runacunataca mindala shutihuanmi ricsin cashca.

Mindalacunaca cucata, utcuta, uchuta, cachita, curitapashmi shuccunahuan rantishpa puriccuna cashca.

Cunan pachapica cullquihuanmi rantishpa causanchic.



mindala

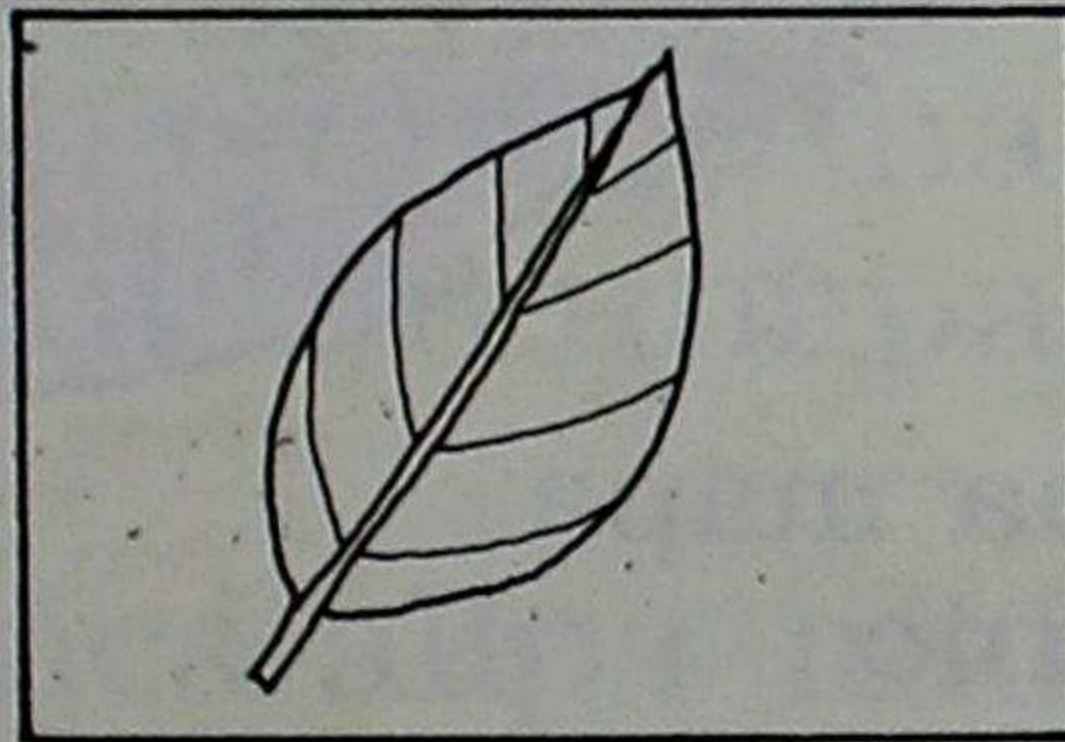

cuca

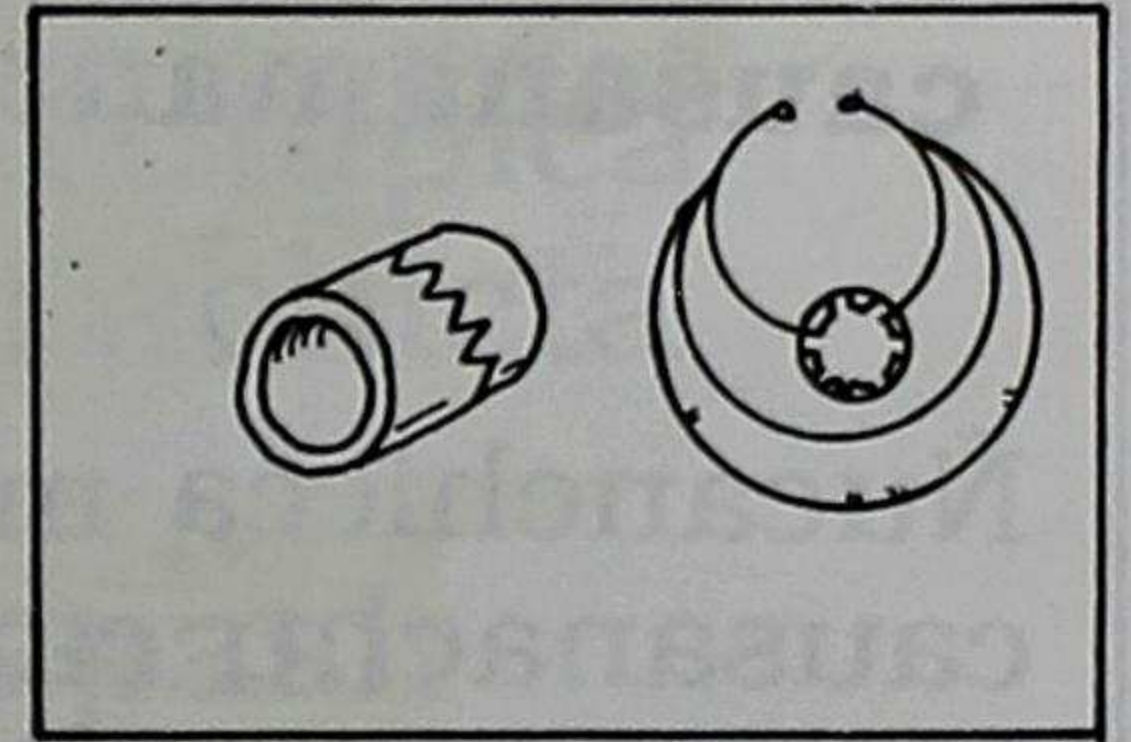

curi

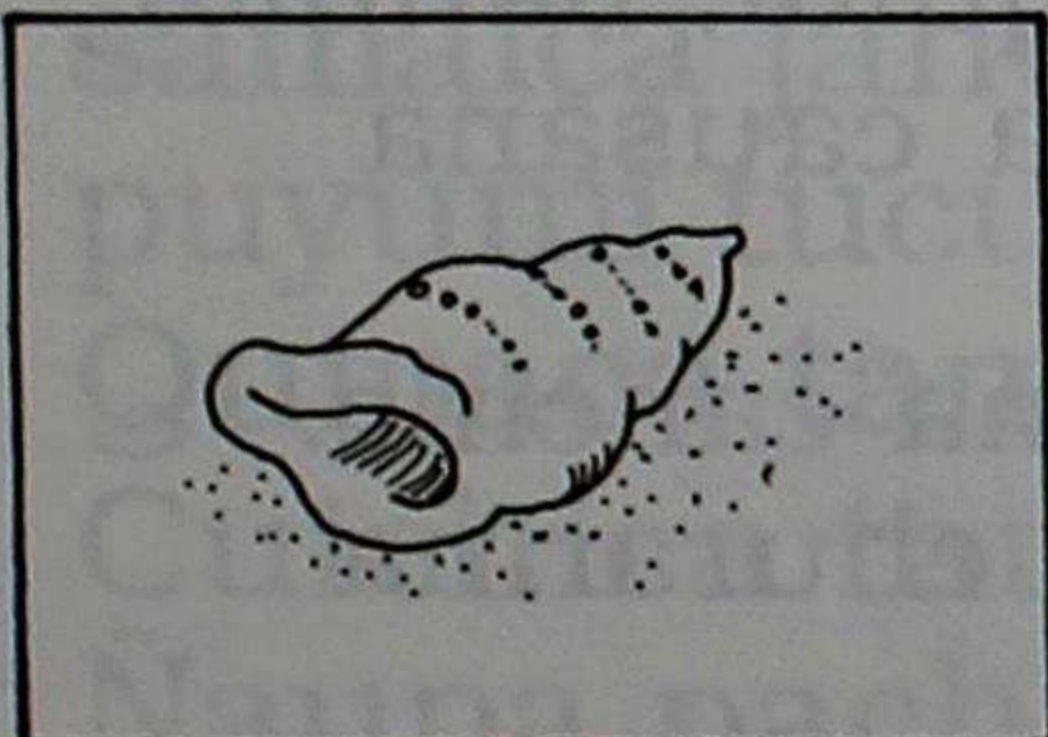

churu

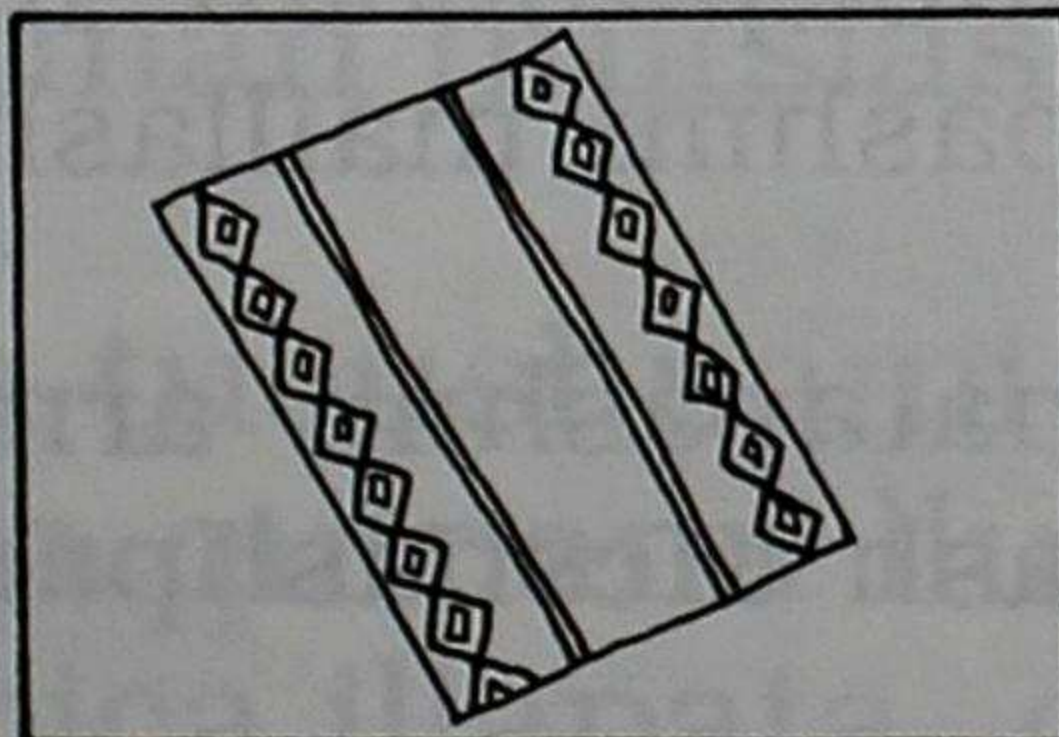

cunpi pacha

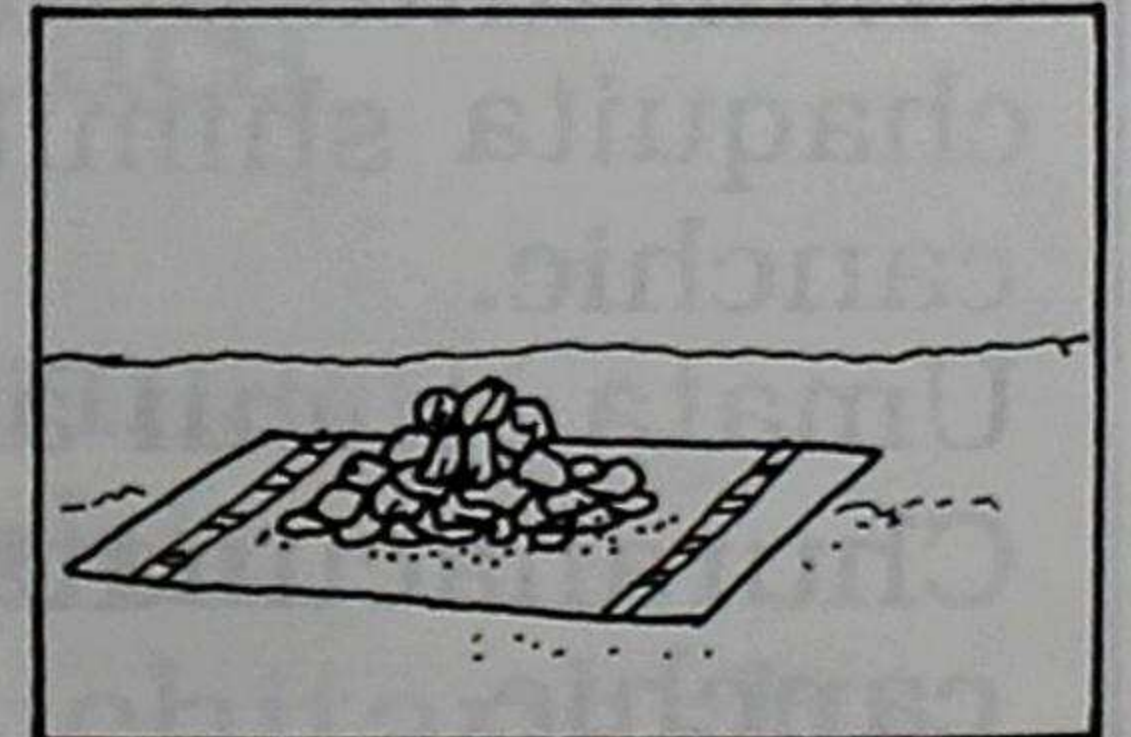

cachi



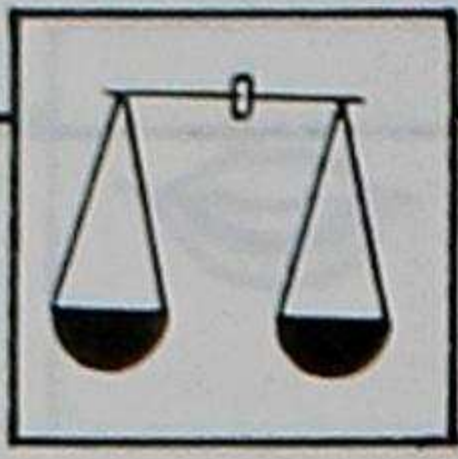

## Alli causanamanta



Tucui runacuna alli causancapacca tauca mutsuicunatami charinchic.

Shina ñucanchic aicha alli cachunca micunyacunata alli yanushpa, alli maillashpami micuna canchic.

Ñucanchic uncushpaca janpicunatami mutsunchic.

Ñucanchic llactapi Janpic Huasicunata churachun munanchic.

Chai Janpic Huasipica janpic mishuta yachactapashmi munanchic.

Shinami ñucanchic uncucppica alli janpincacuna.

## Ama mapa causanamanta

Ñucanchicca mana mapa causanachu canchic.

Mapa causacpica uncuicunapash japinmi.

Chaimanta punchan punchan maquita, ñahuita, chaquita shimitapashmi maillashpa causana canchic.

Umata tucui aichatapashmi armana canchic.

Churanacunatapash tacshashpami churarina canchic.

Cashna rurashpa causacpica mana uncuicunaca japinchu.



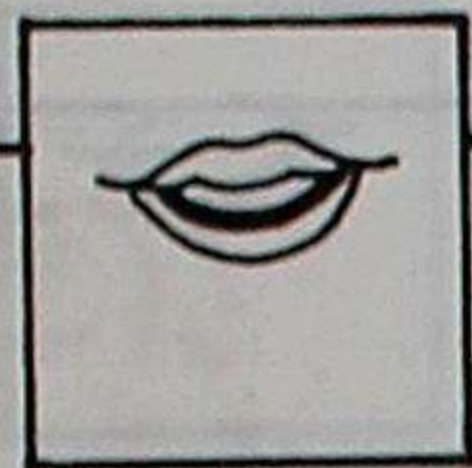

## Achicmanta

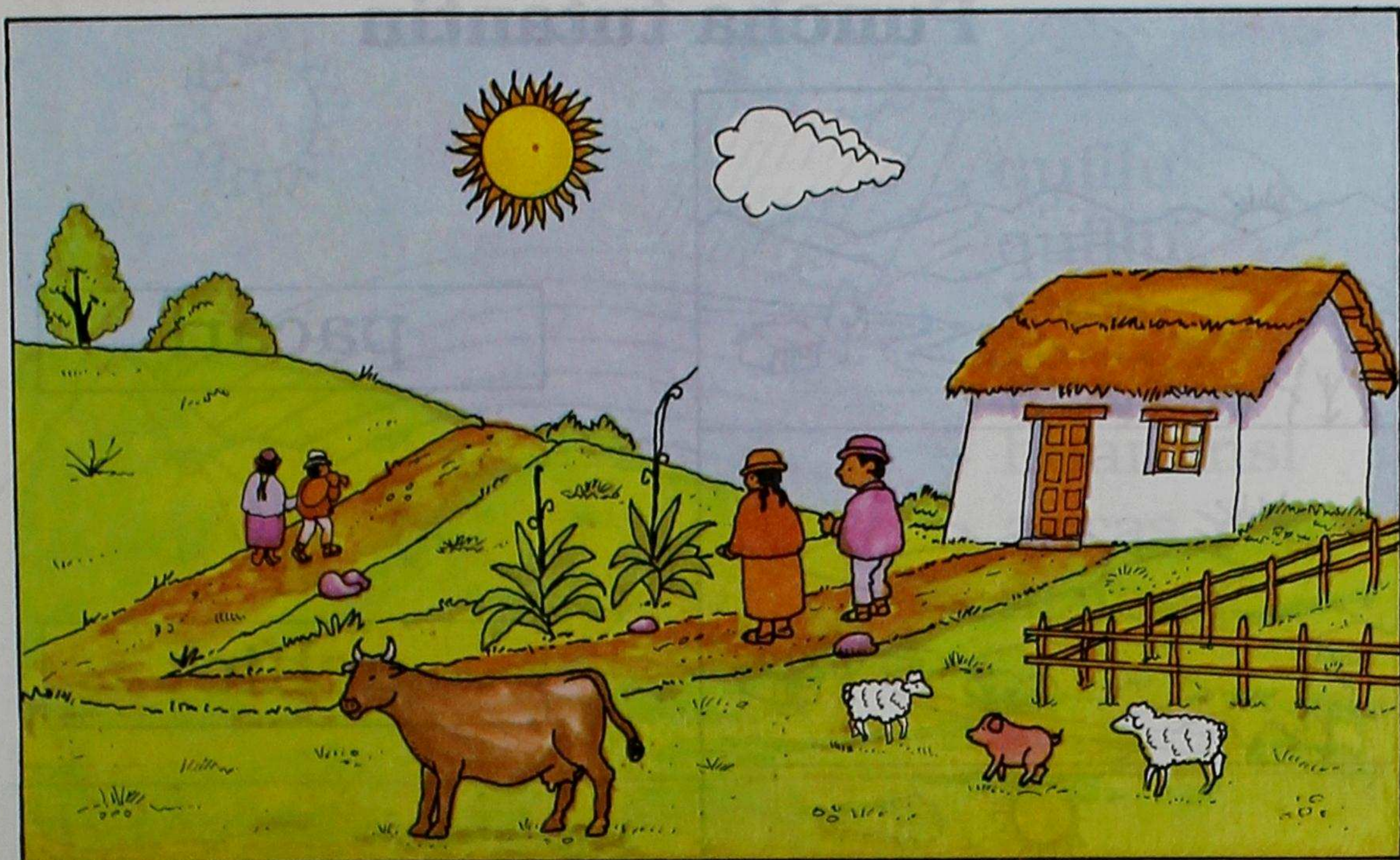

Inti taitataca tucui causaccunami  
punchan punchan cushiyaihuan  
tutamantapi chasquincuna. Tutapica  
mamaquilla cuillurcunapash achicta  
cun.

Inti cunuihuanca allpa mamapash  
cunurishpa samaita llucshichinmi. Cai  
samaica jahuaman huitshiashpaca  
puyumi tucun.

Quipaca tamia tucushpami urman.

Cuichica tamia quipami llucshin.

Ñaupacha pachapica illapata cuichitapash  
apunchicta shinami charin cashca.

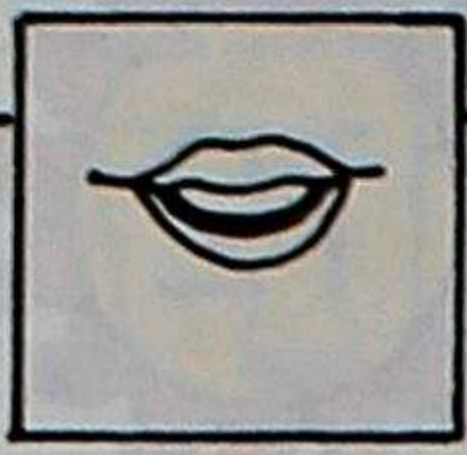

# Puncha tutantin

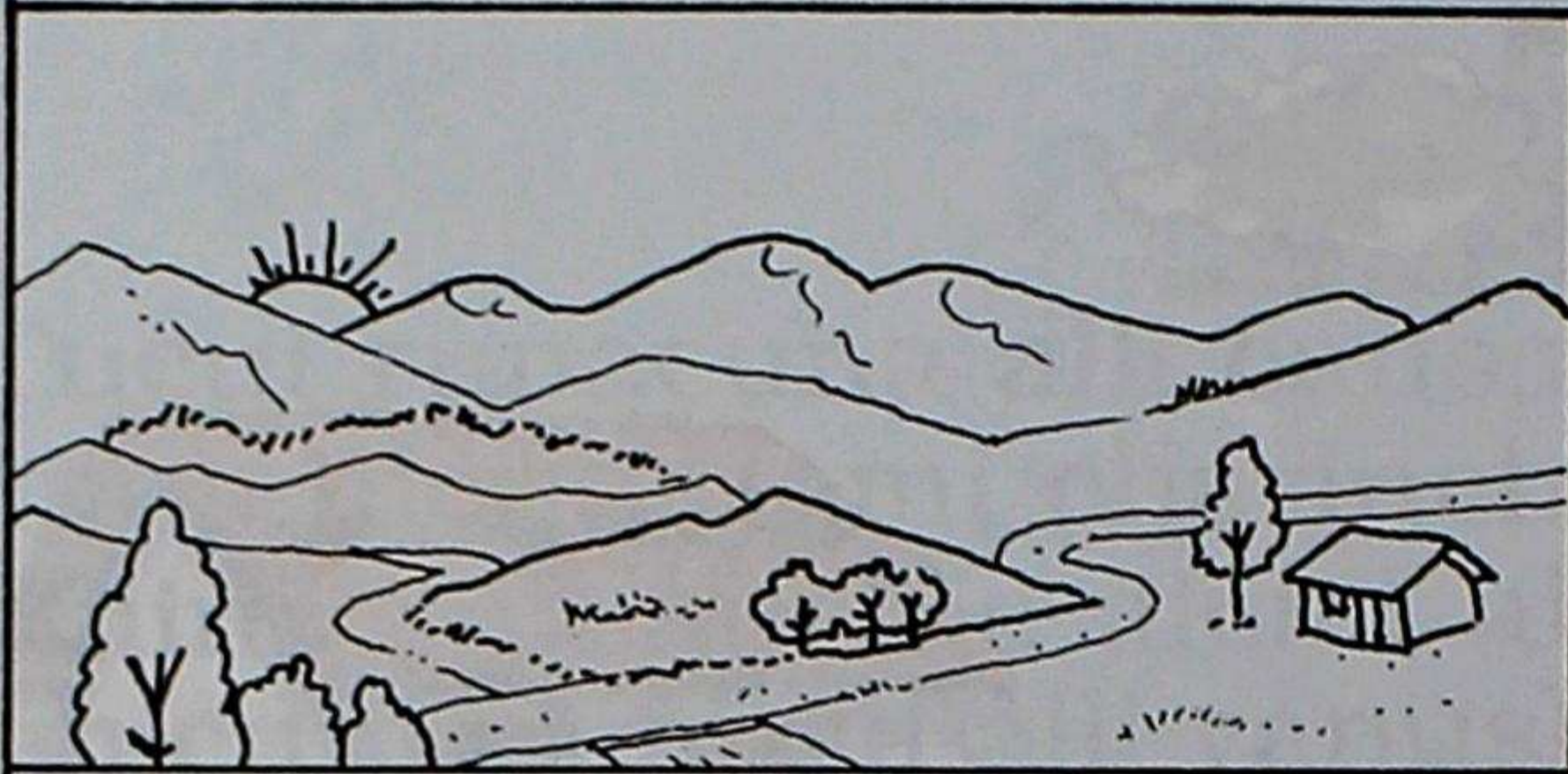

pacari



achic

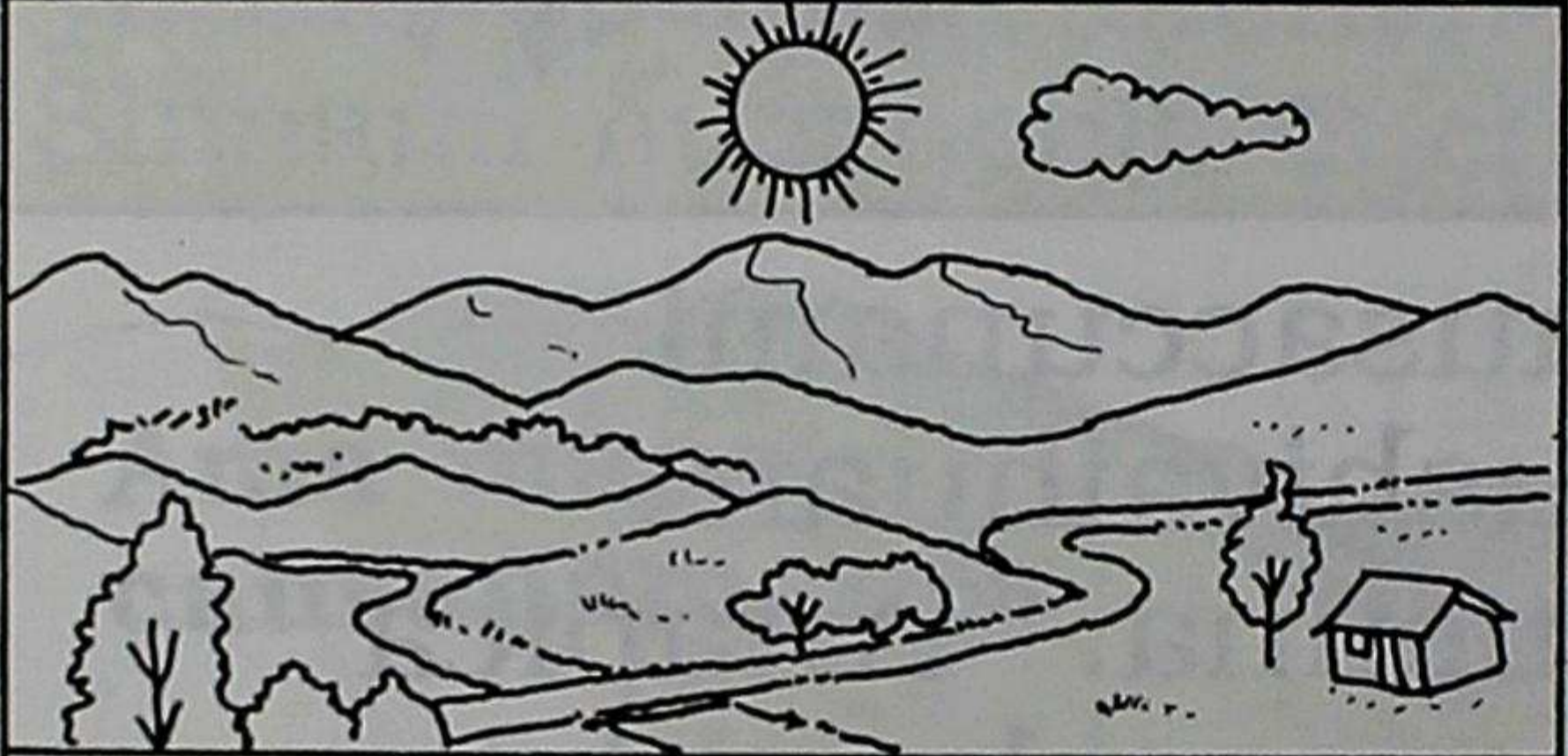

puncha

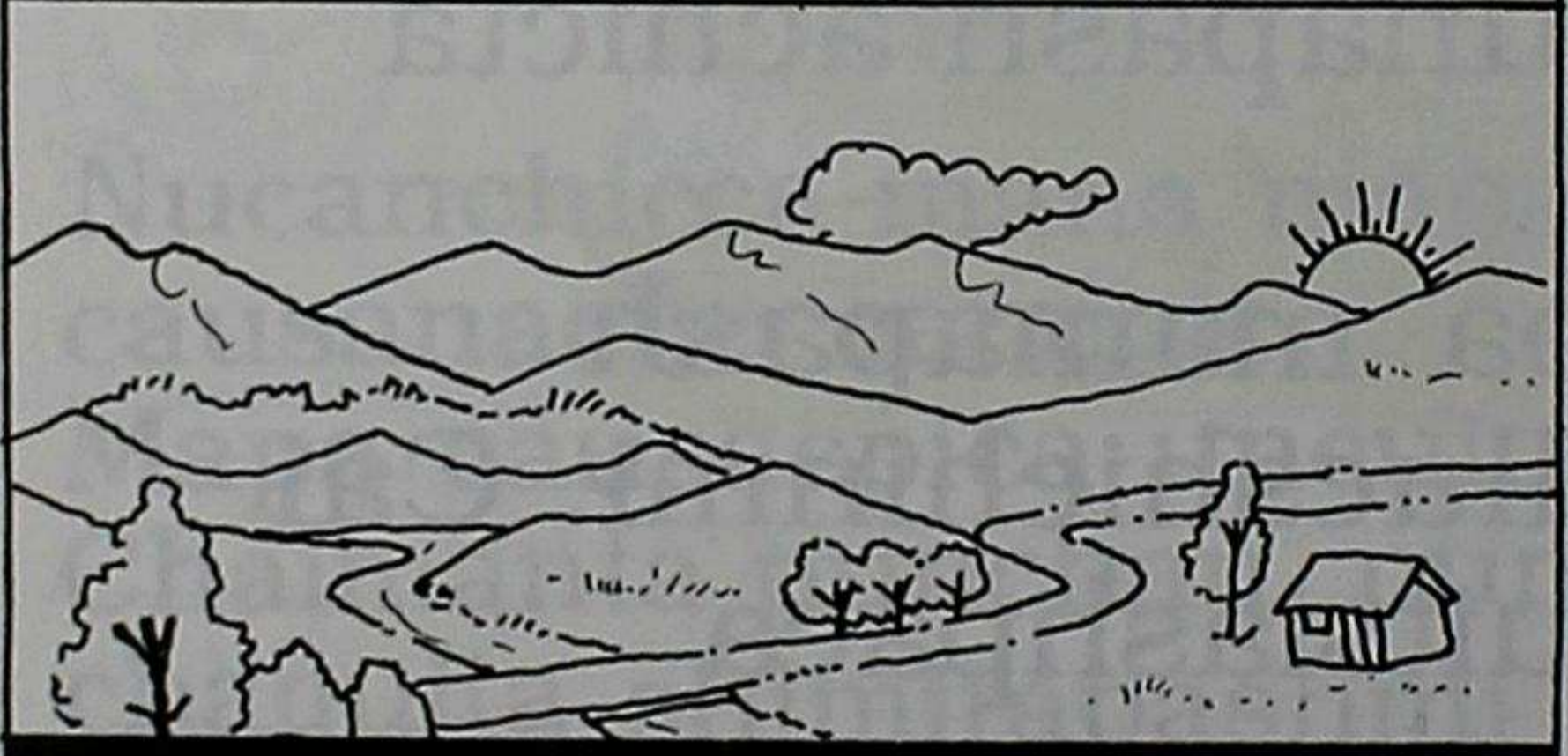

chishi



tuta

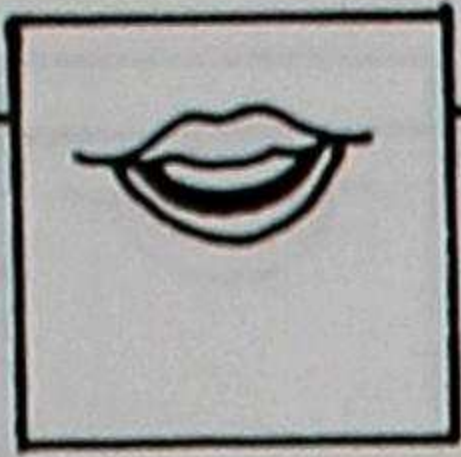

# Cuichi

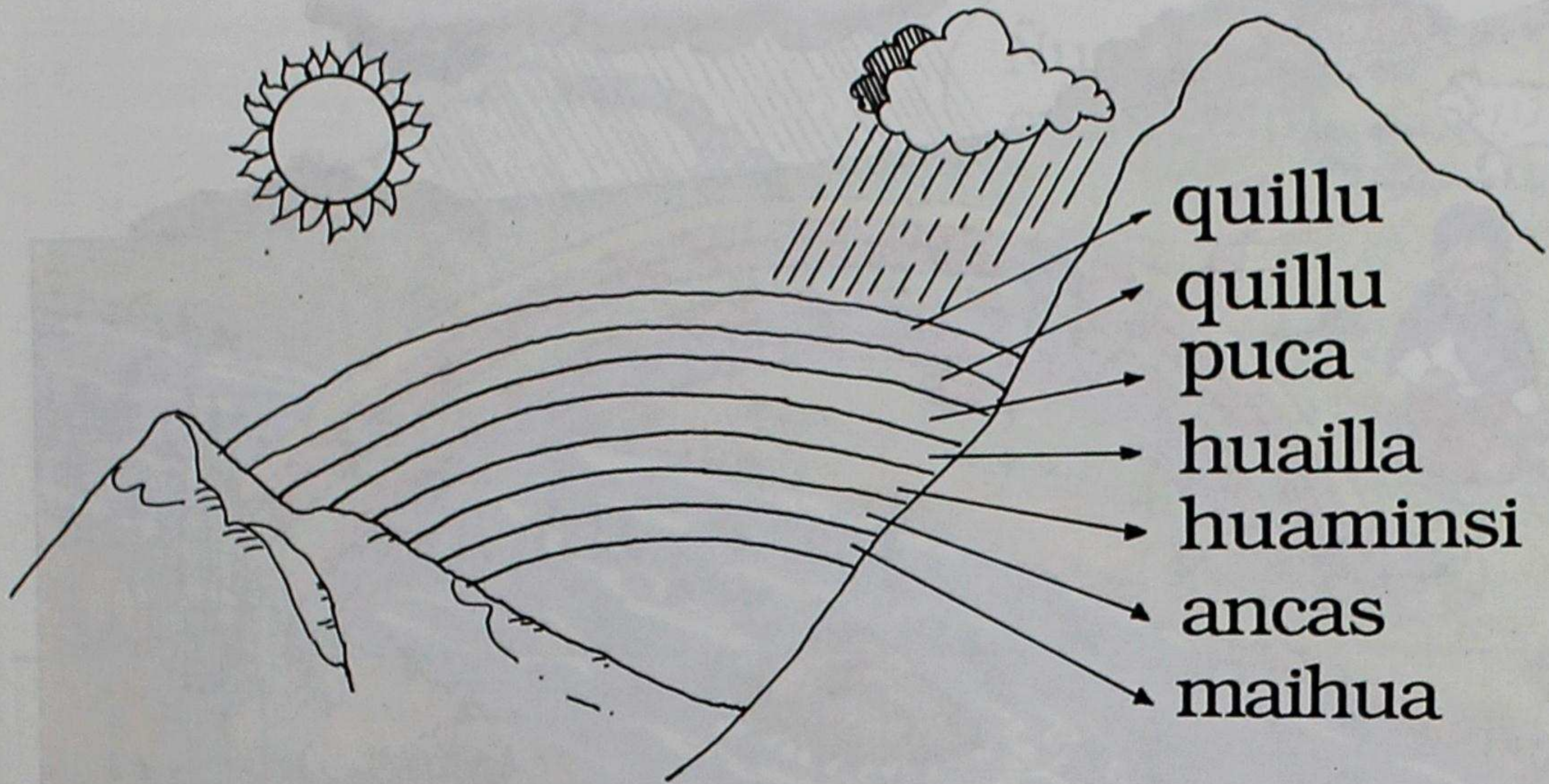

## Cuichi hualanpariuntin

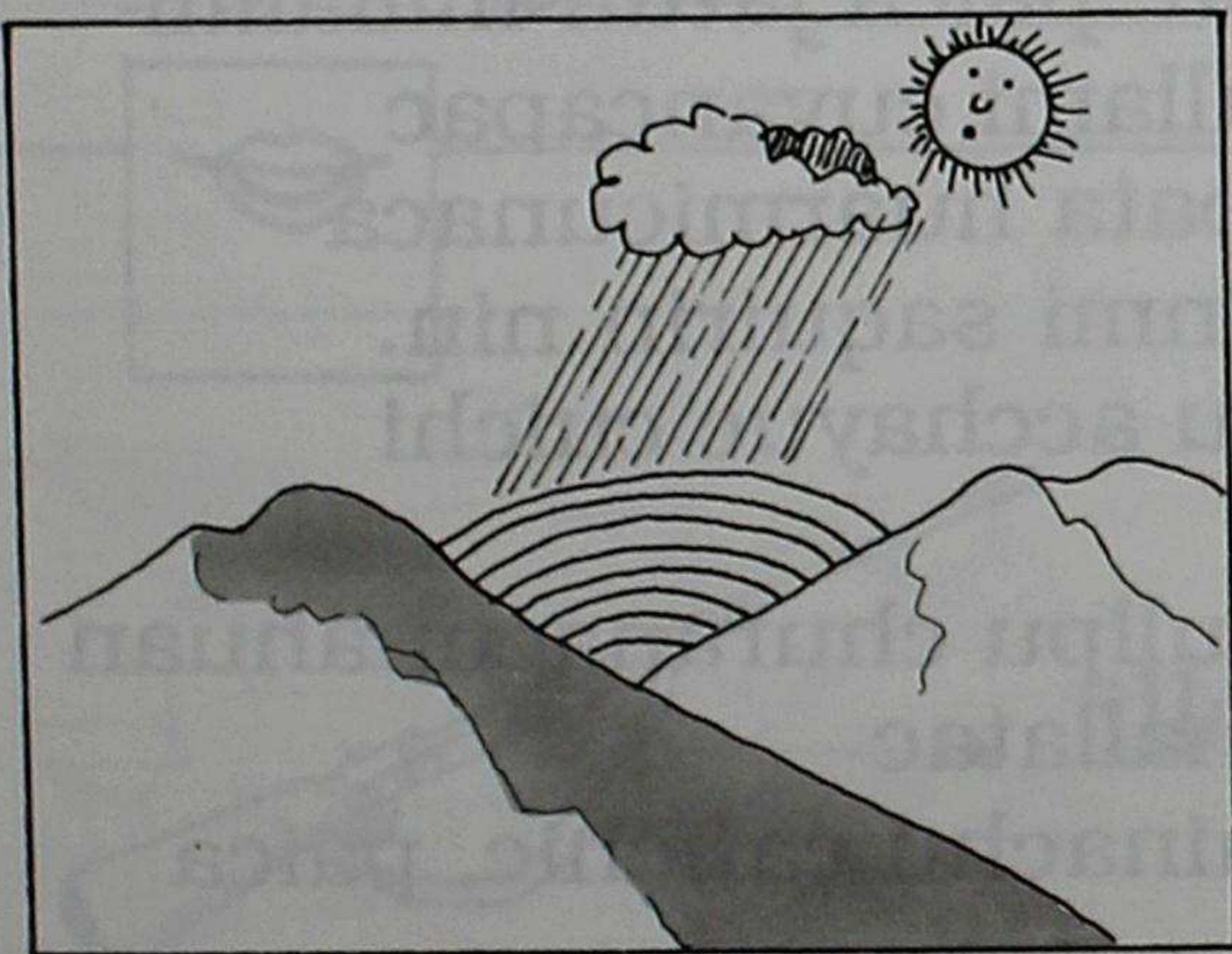

cuichi

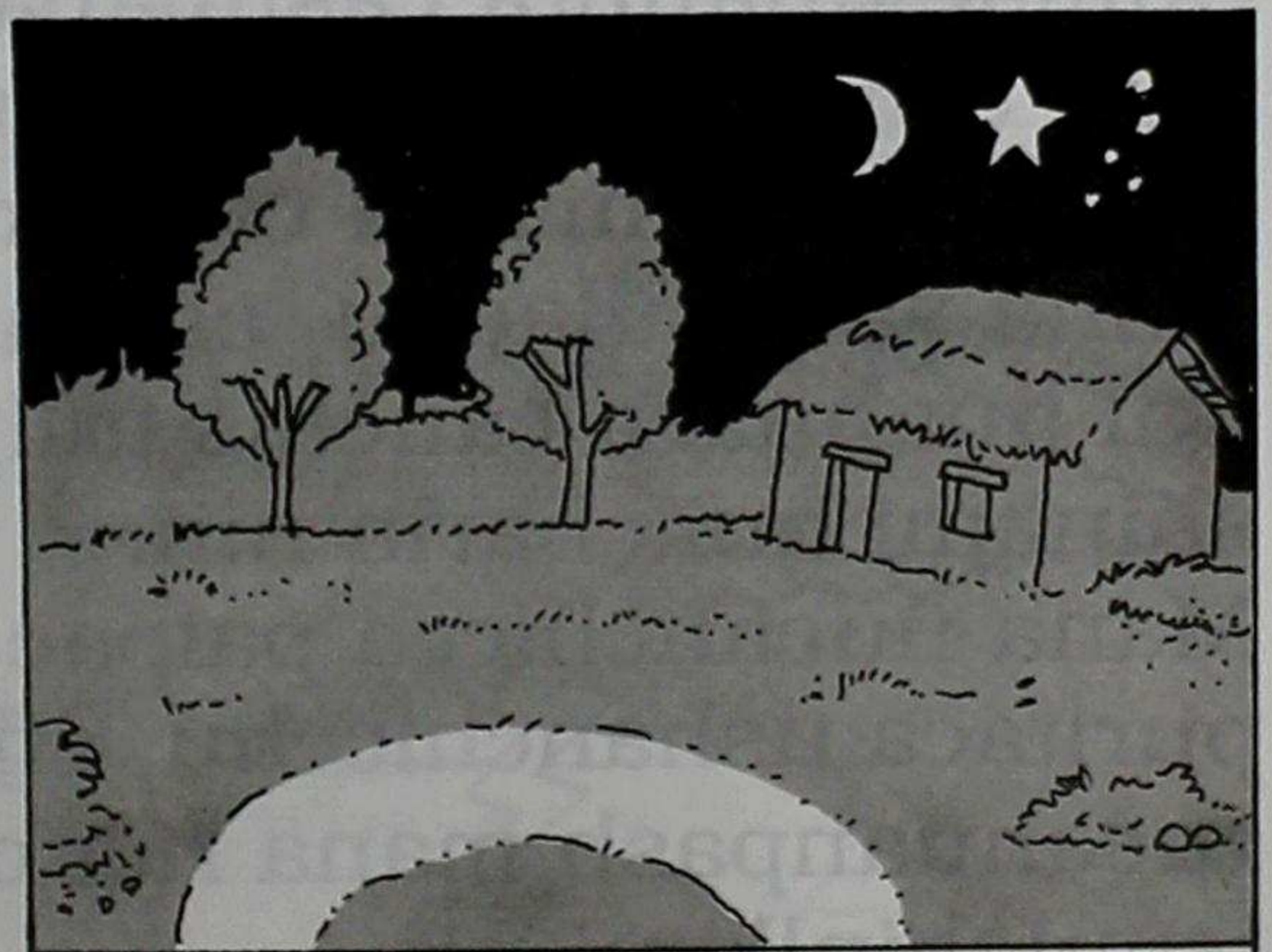

hualanpariu

# Cuichimanta

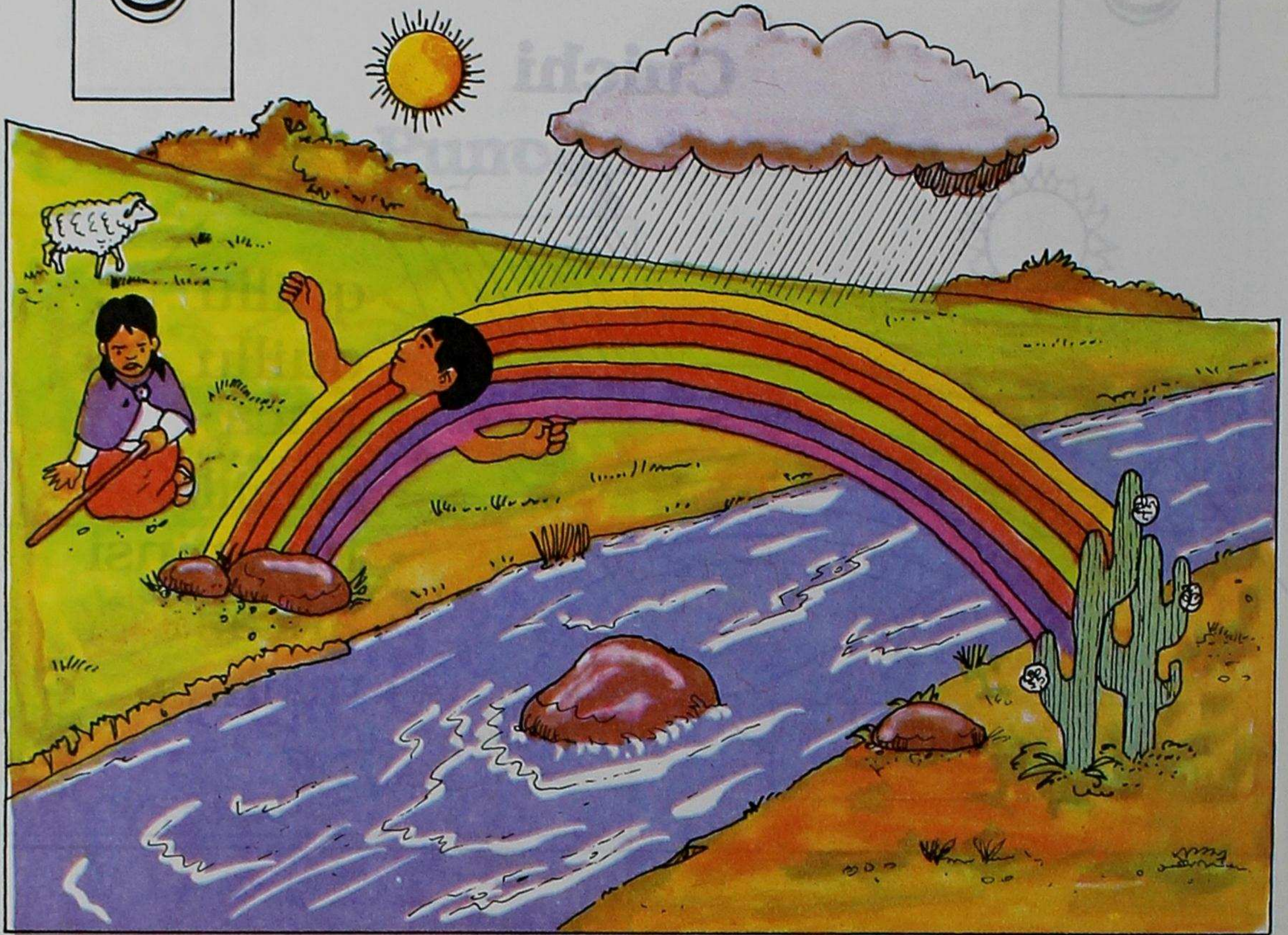
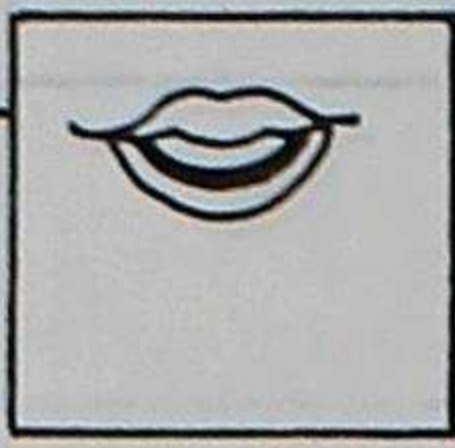

Cuichica sumac huanprami, paica jatun cashapi,  
rumipi huaicupipashmi causan.  
Sumac huanpra cashpapash paica jatun millaimi  
can. Sumac huarmicunactallami cuyancapac  
munan, chaimanta cai panpata huarmicunaca  
mana yallinallachu chichunmi saquirin nin.  
Cai huahuaca canchis tullpu acchayuc cuichi  
shinami huacharin nin.  
Mana ñucanchicca paipac tullpu churanacunahuan  
puritaca ushanchicchu, shinallatac  
rucahuanpash mana ricuchinachu canchic, paica  
ismuchinllami nin.

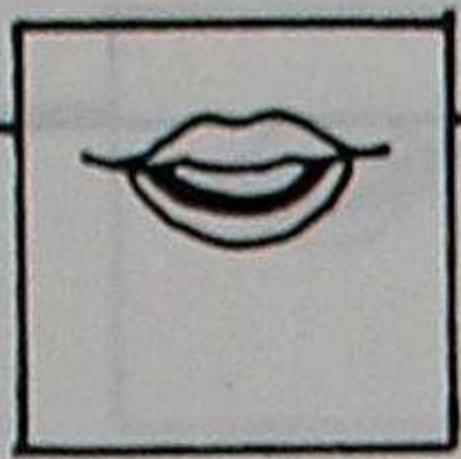

Ñucami culun  
culun nini

llipiacun

illapa

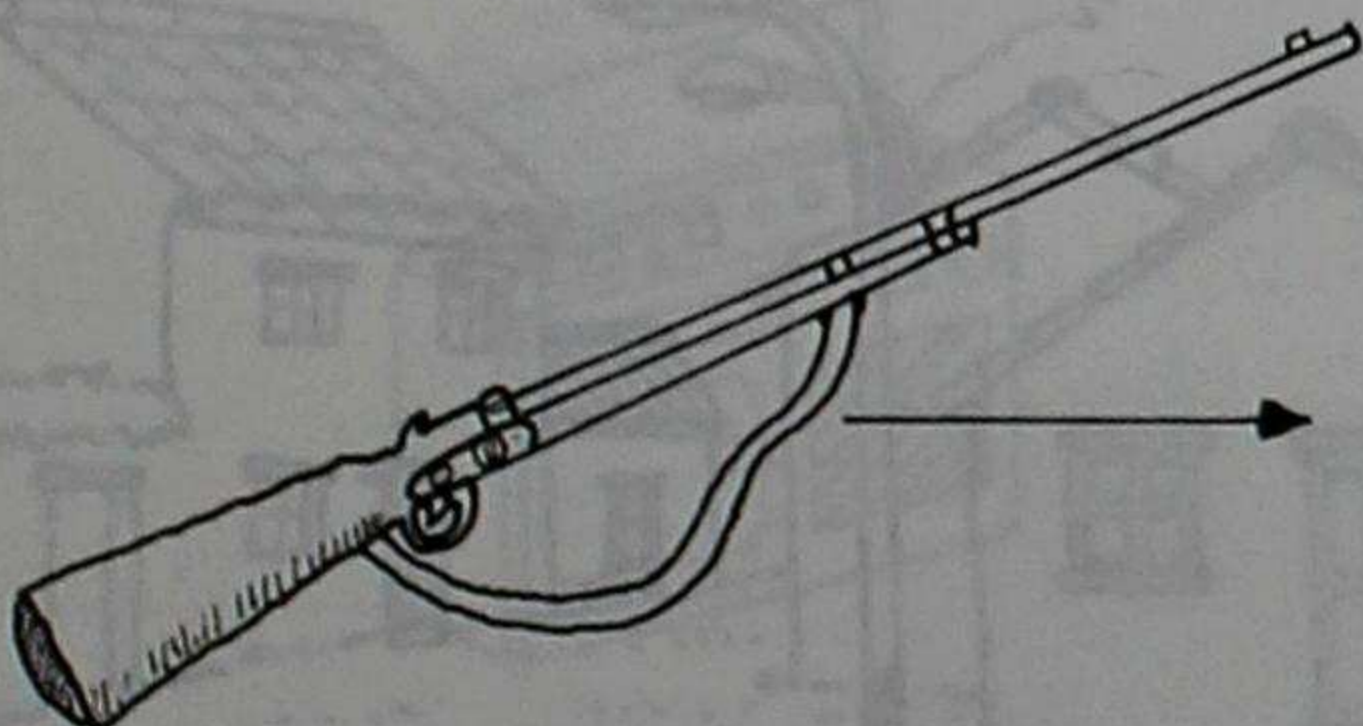
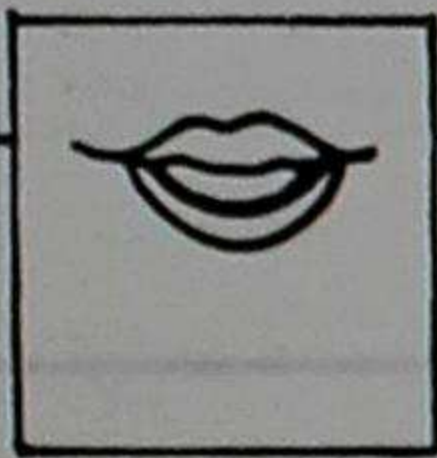
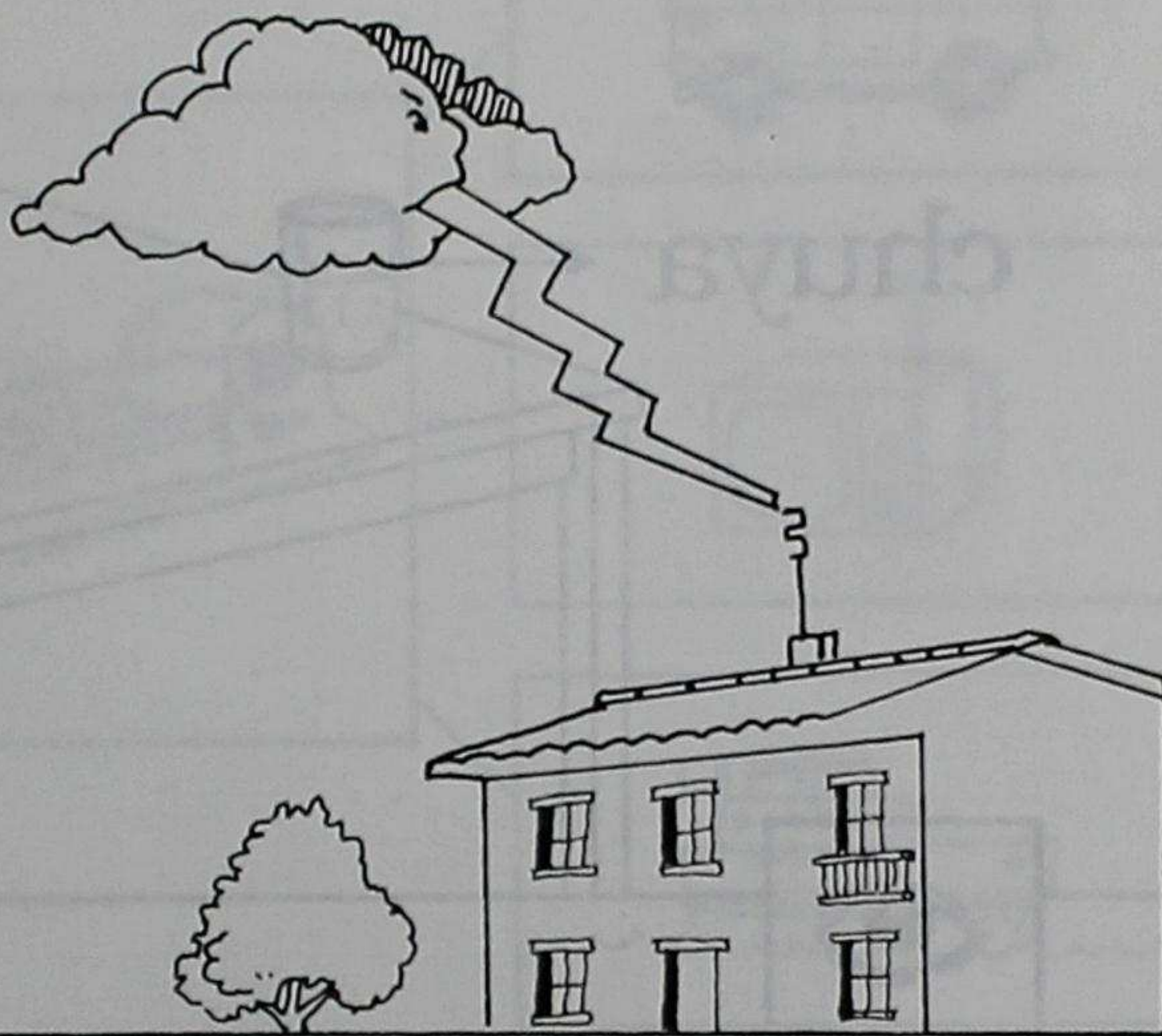
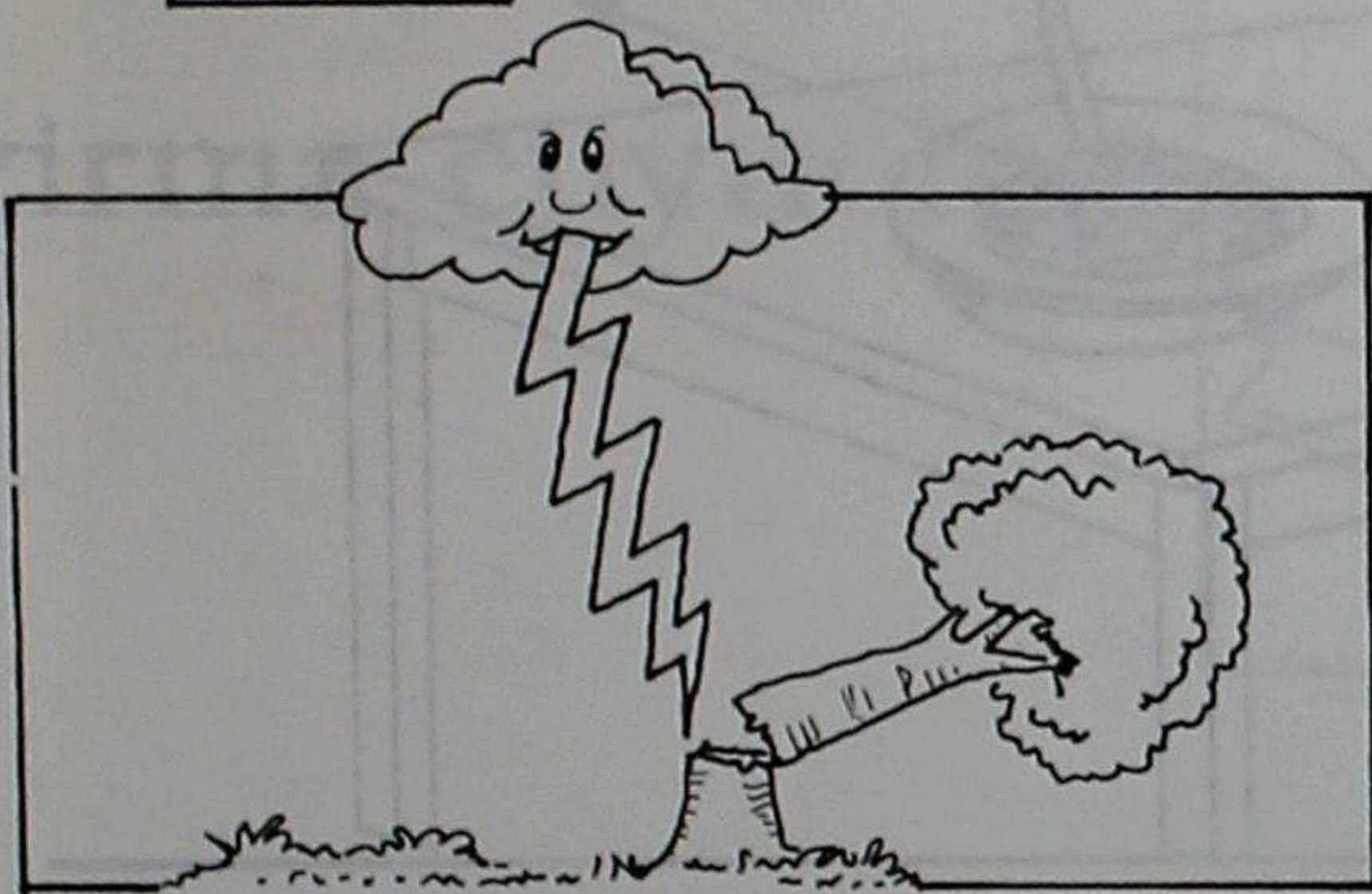
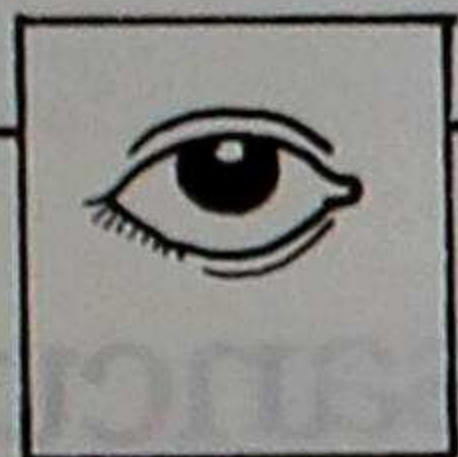

illapa

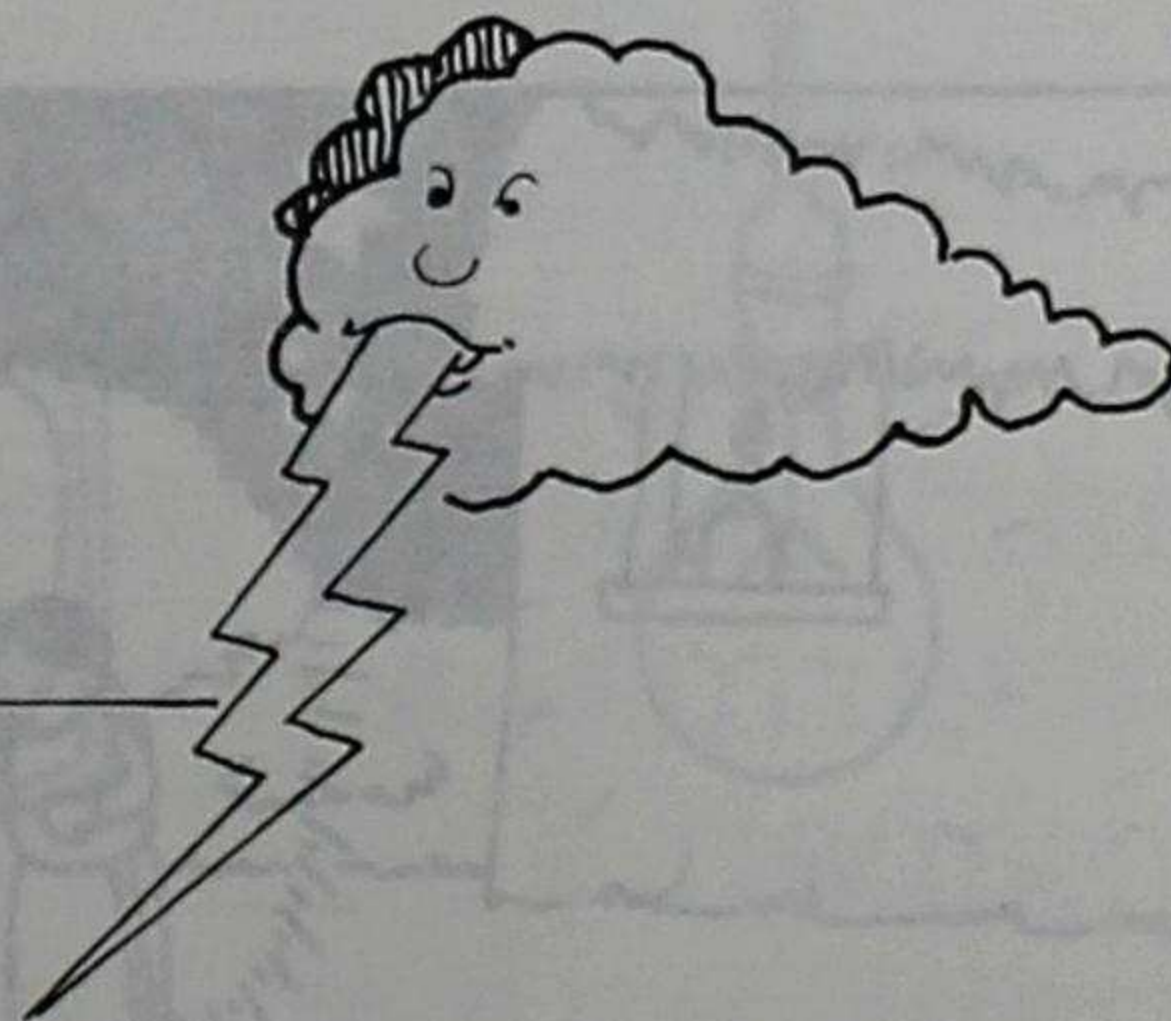

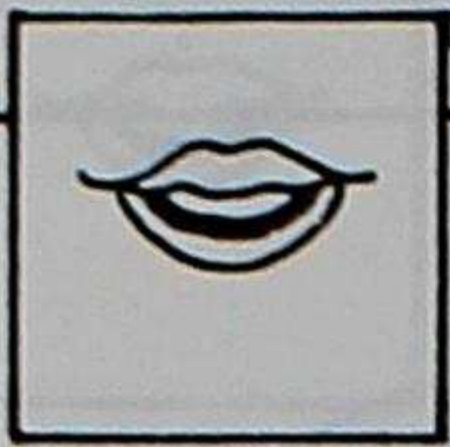

# Chuya sancupash

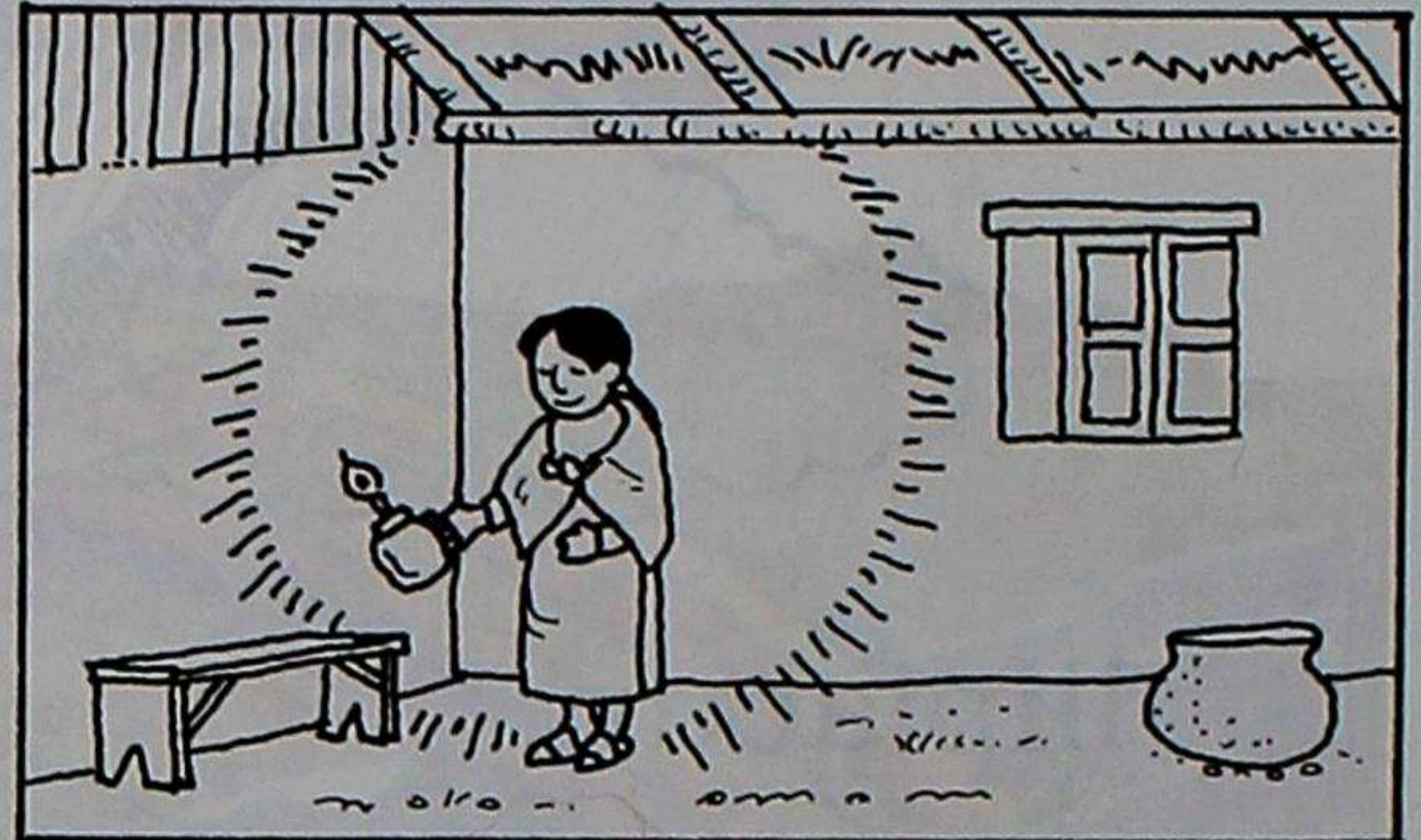
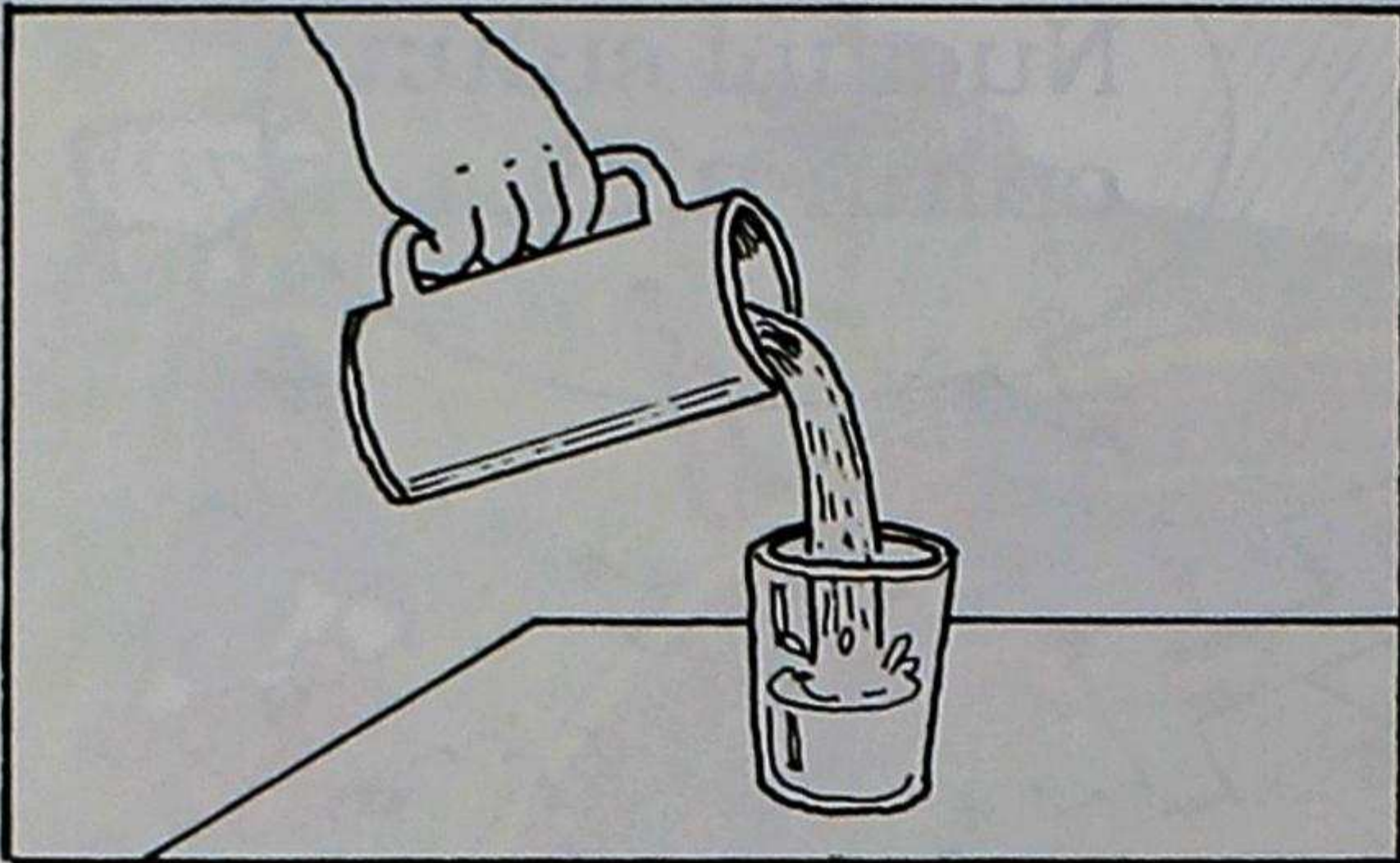

chuya

chuya

sancu

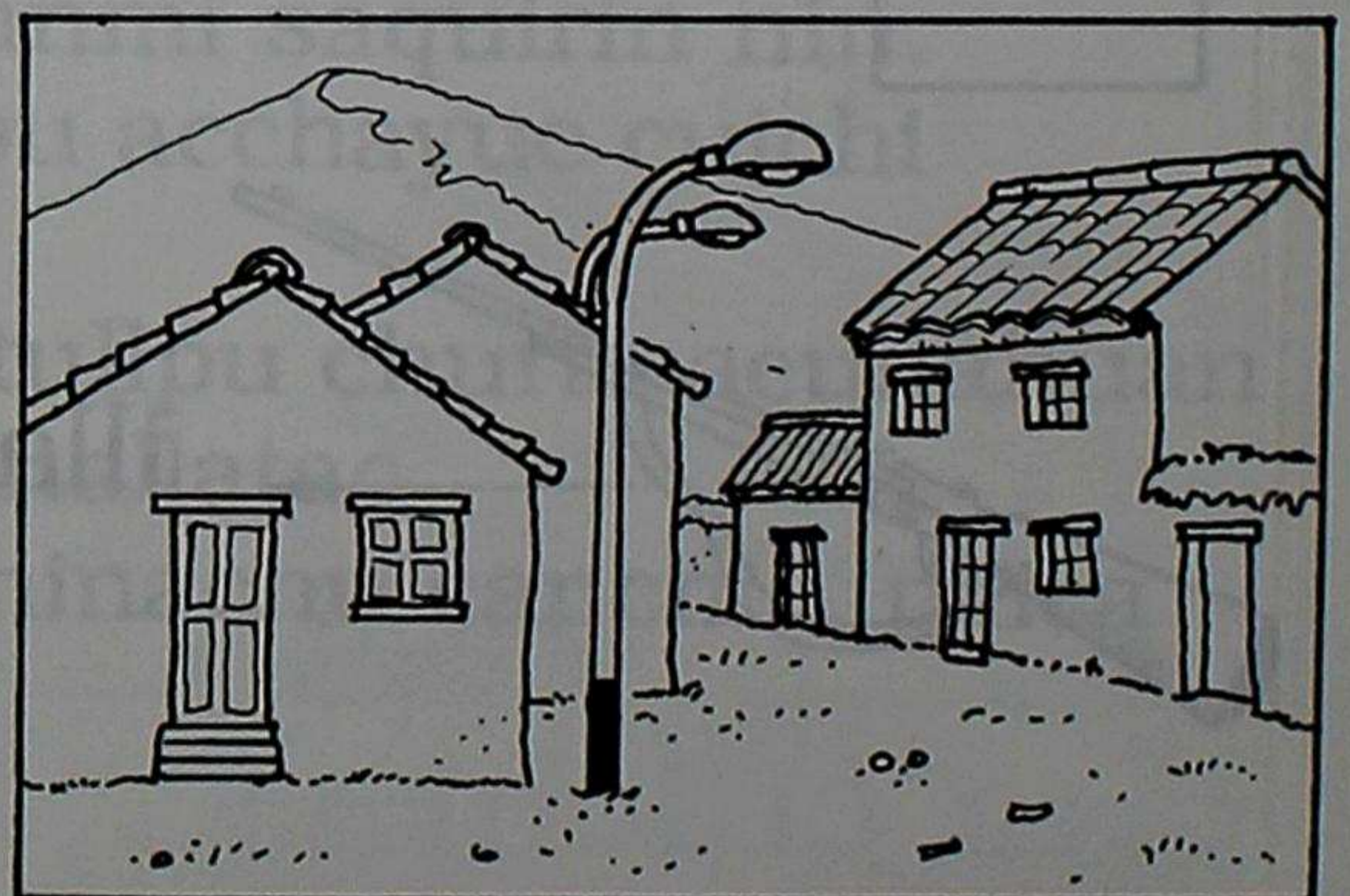
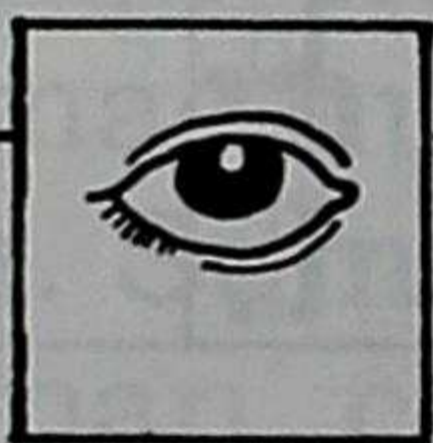
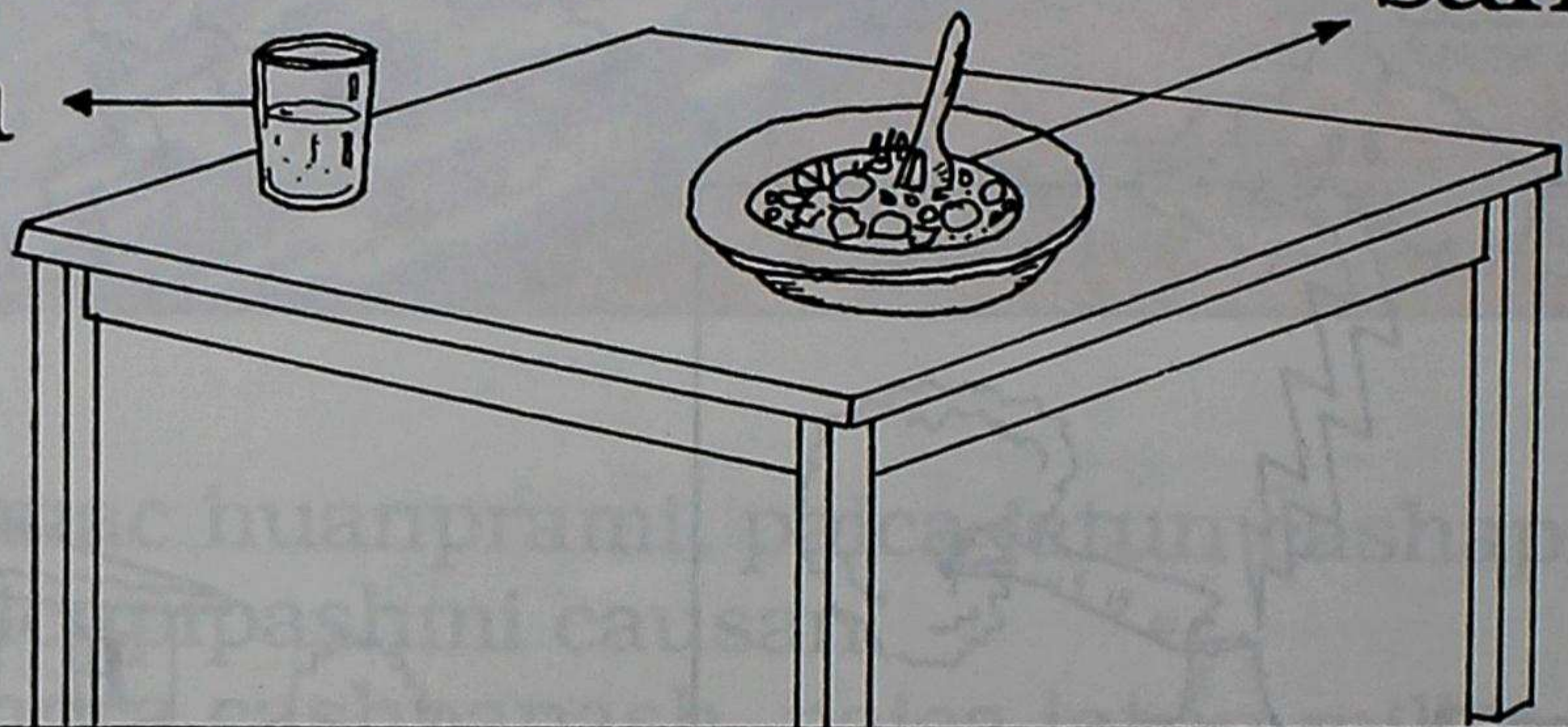

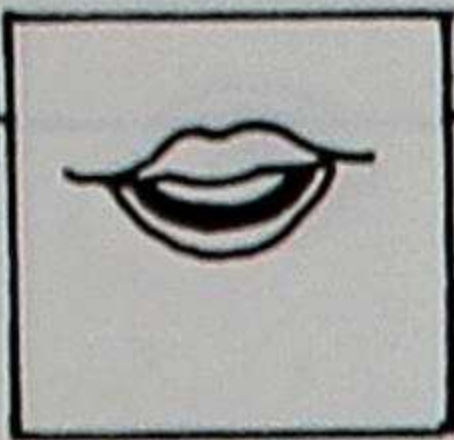

# zirmamanta

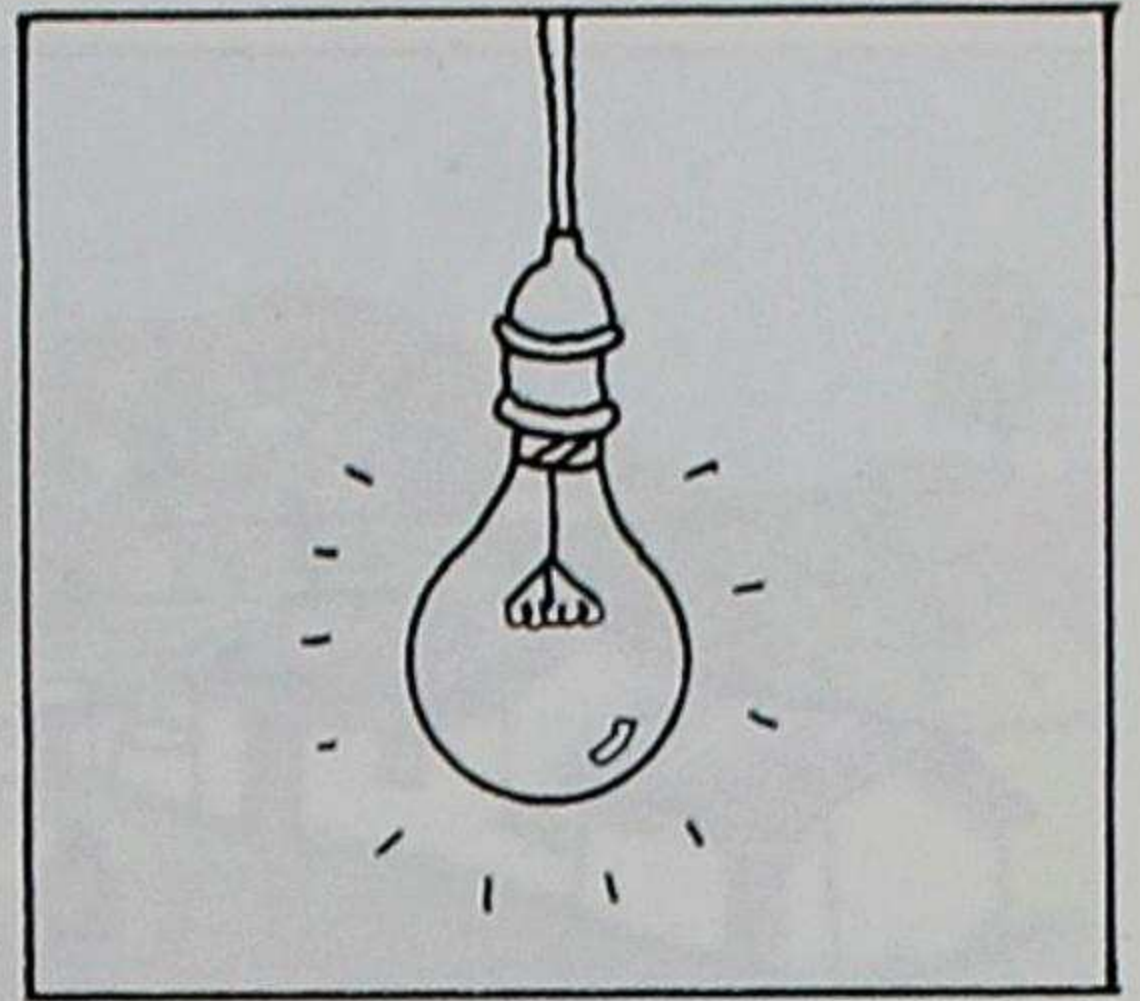
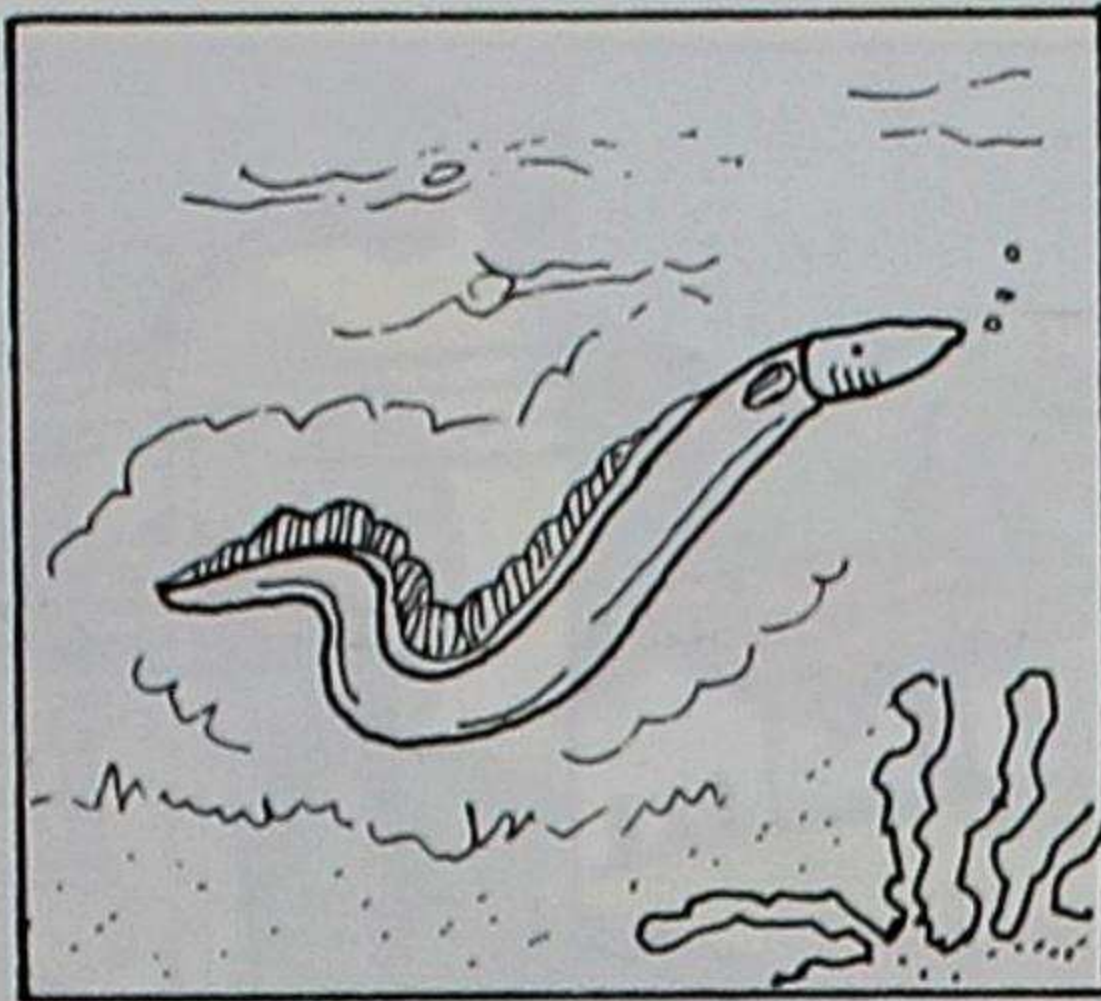
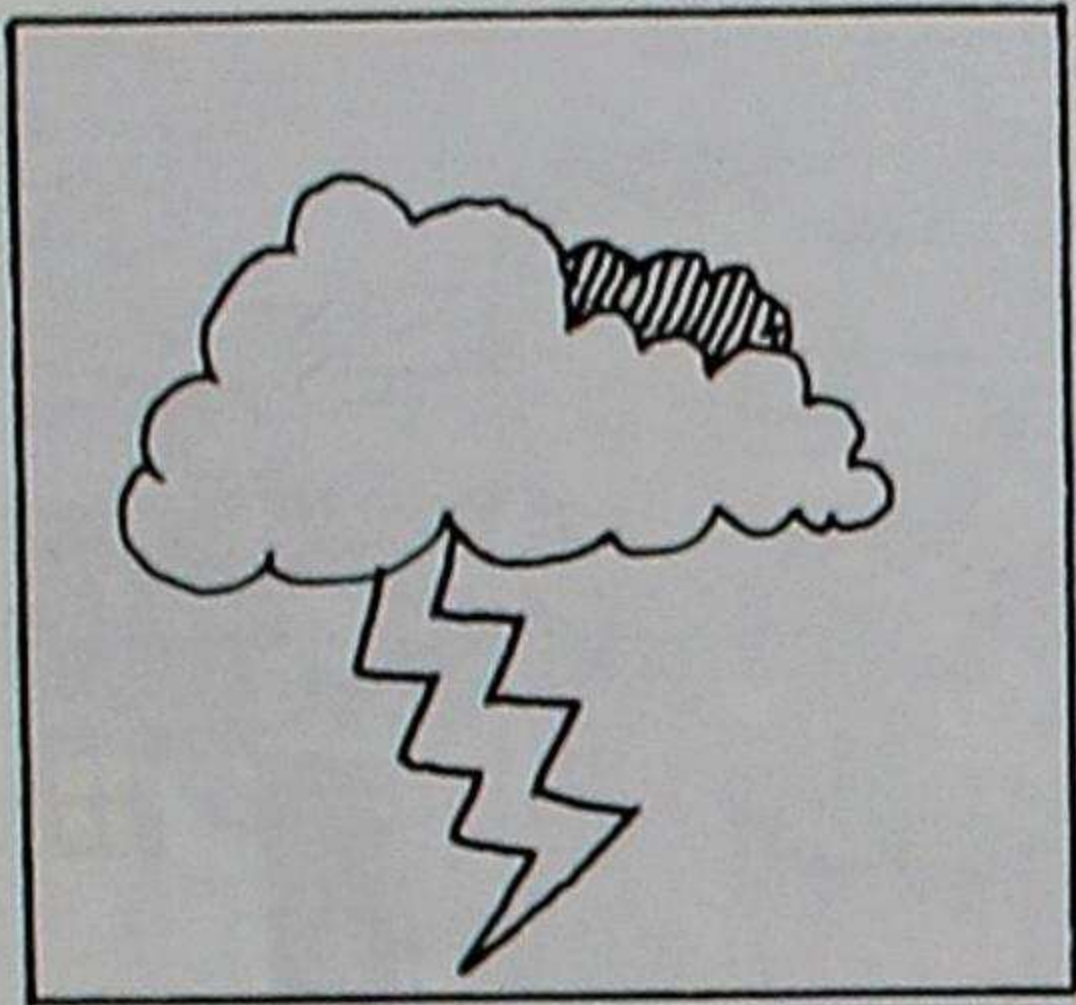

# zirna cuyuchic

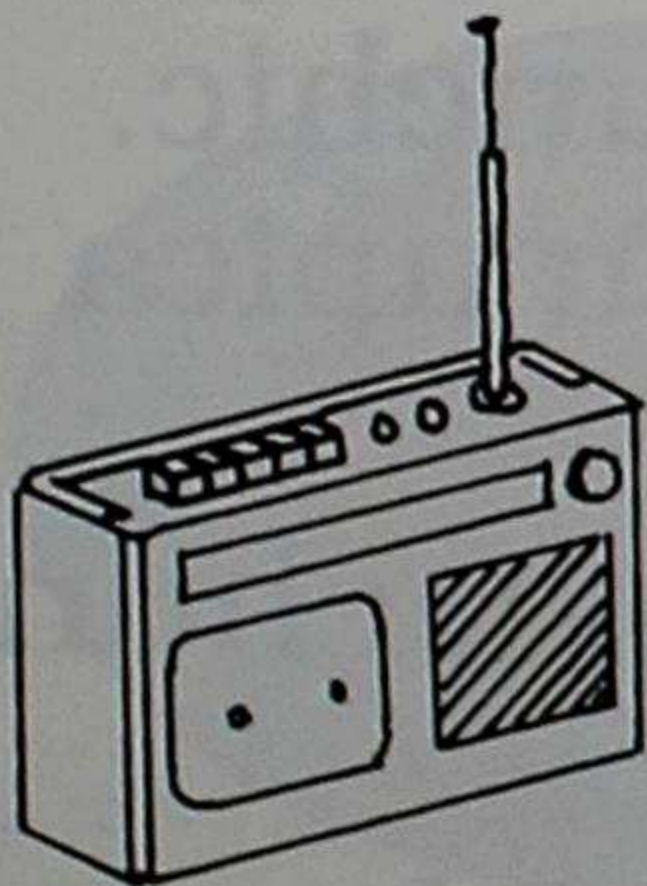
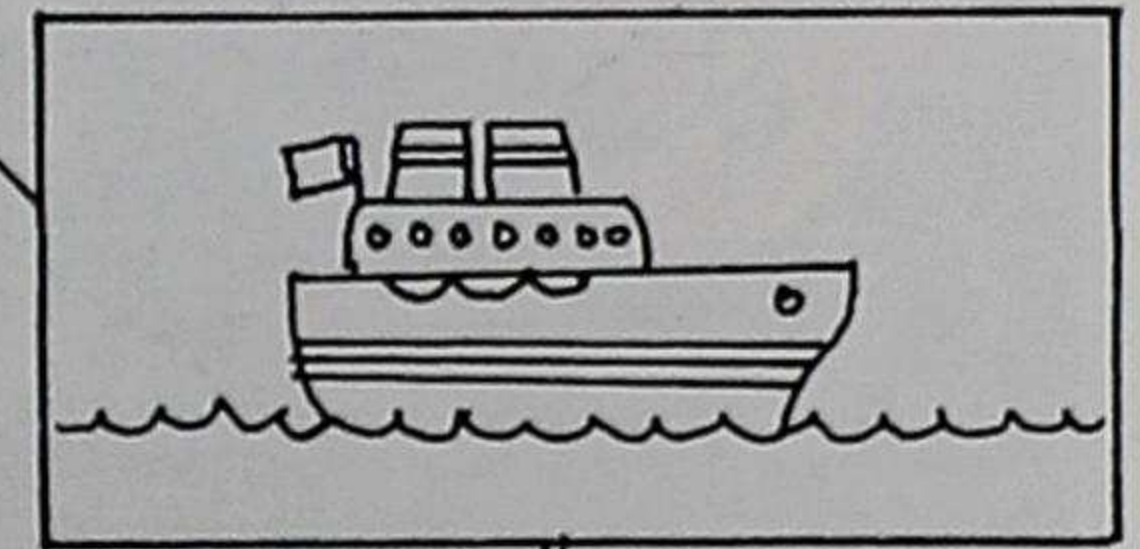
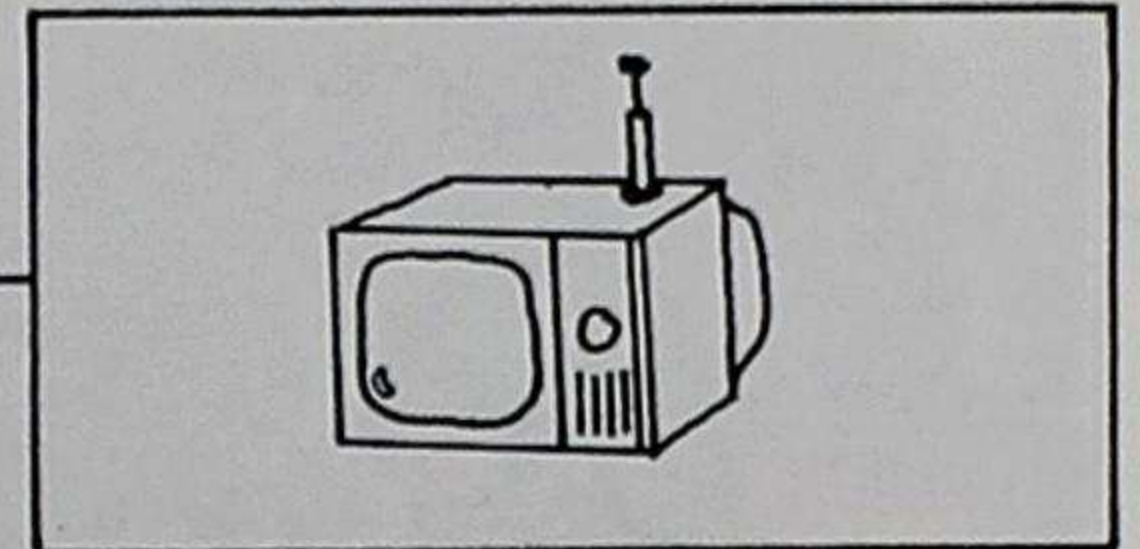
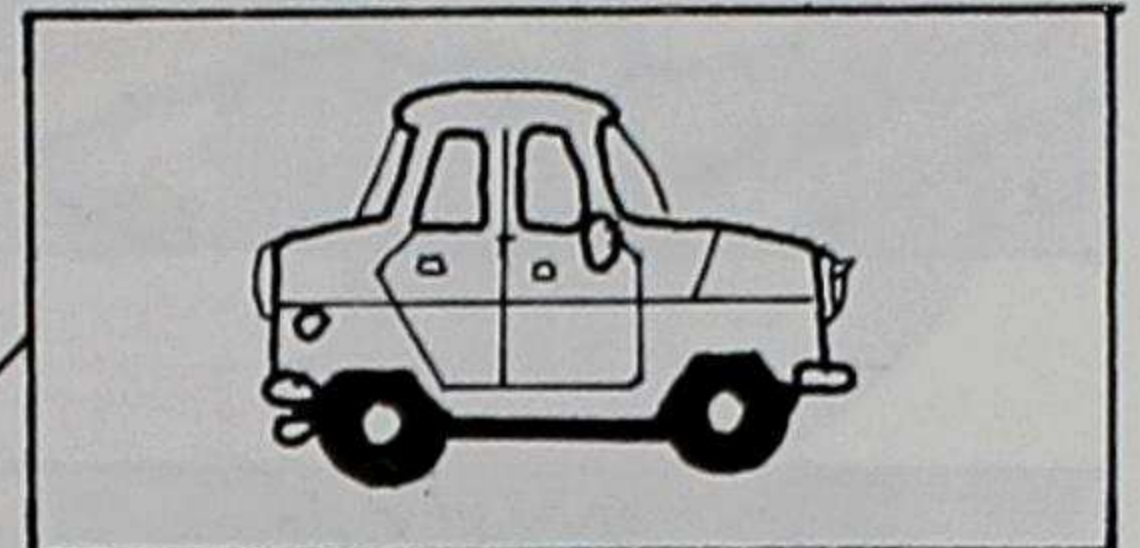
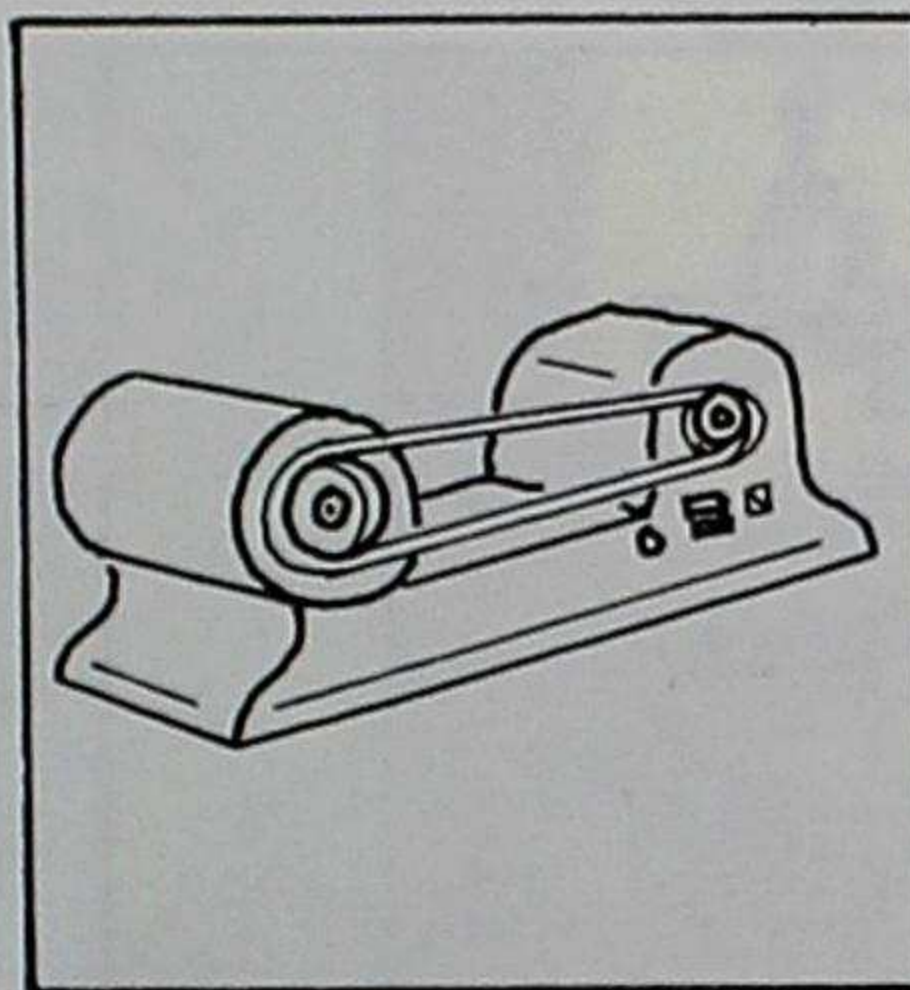

uyachic

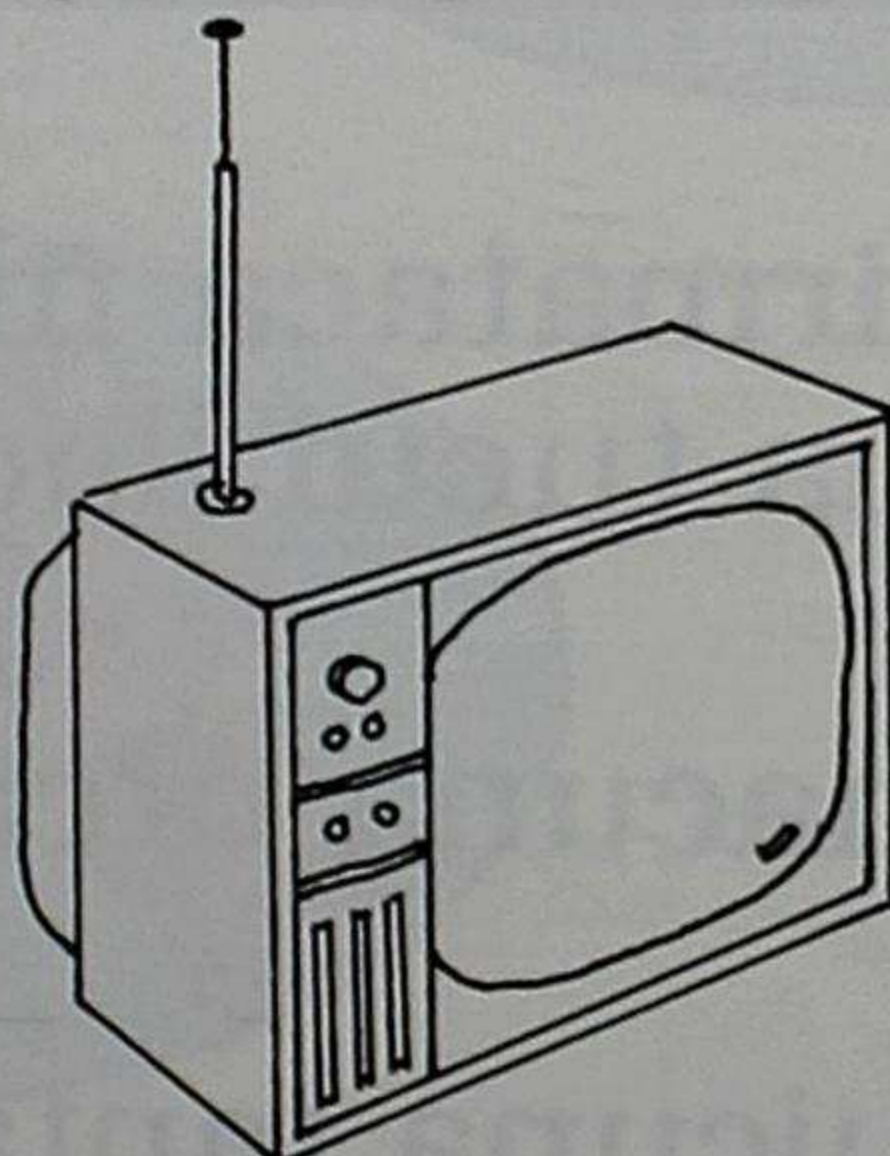

ricuchic

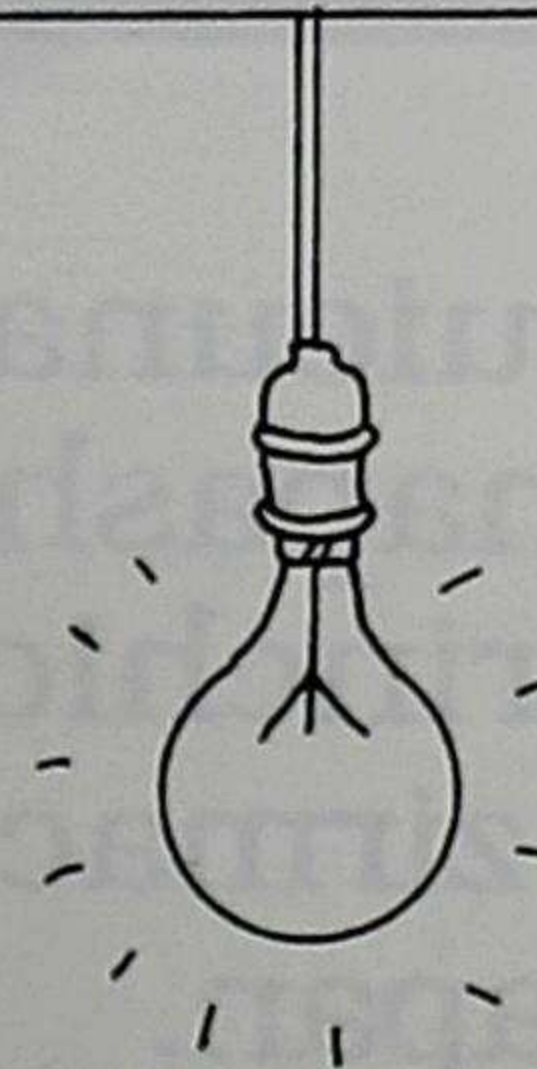

achiccuc



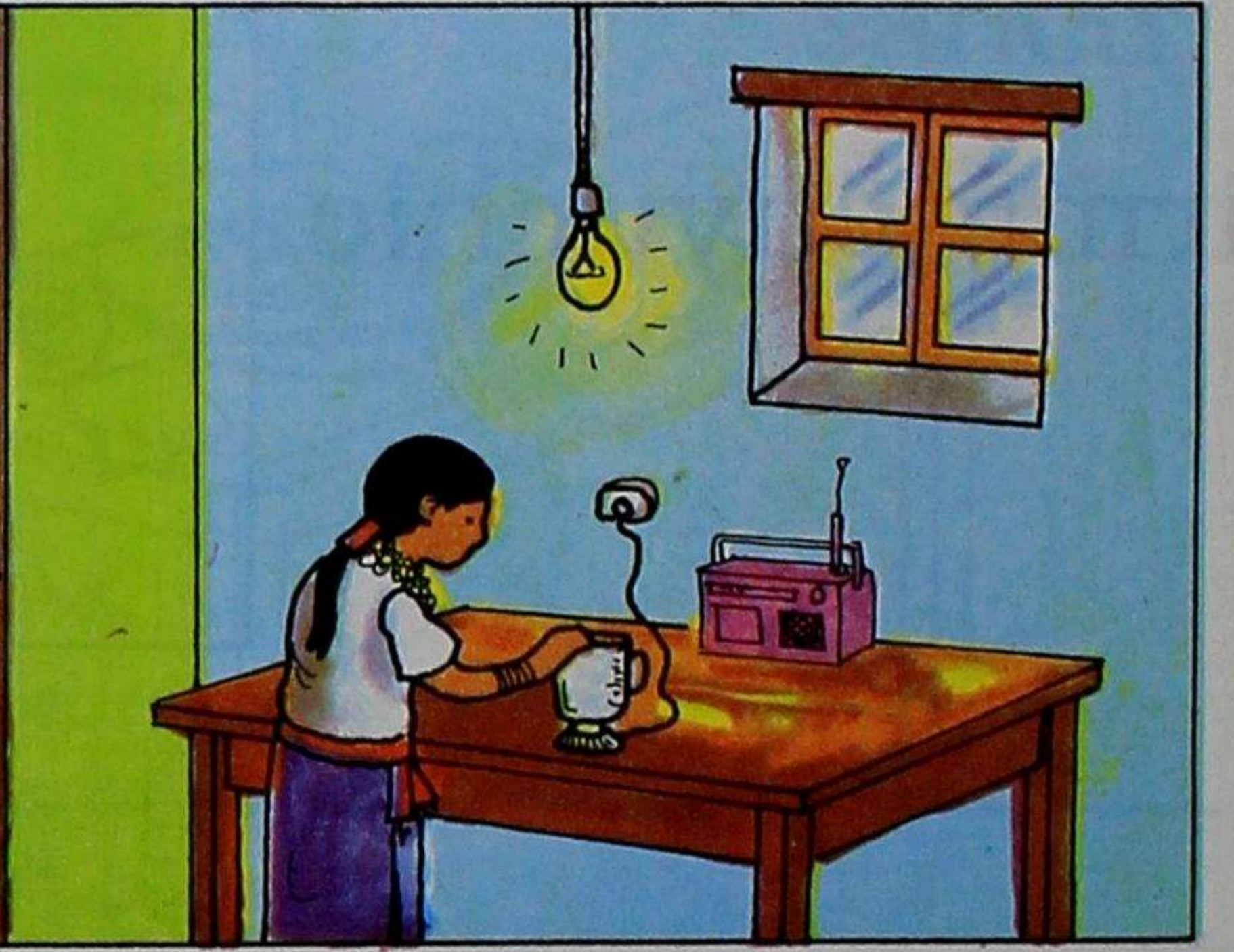
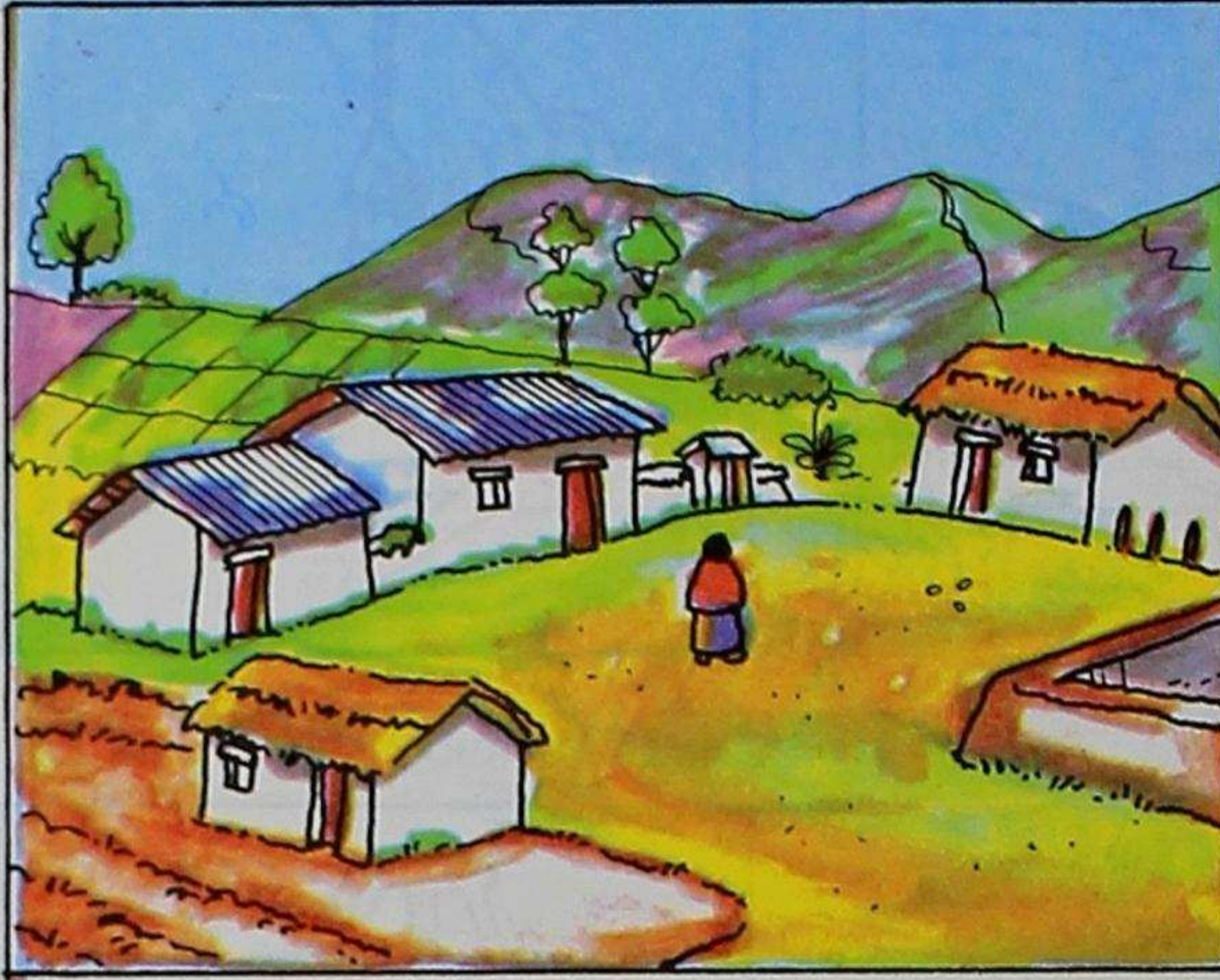

Tucuicunami zirmataca mutsunchic.  
Shinapash mana tucui llactacunapica  
charinchicchu.  
Cai zirmaca runacuna utca llancachun  
yanapan.  
Chaimanta tucuicuna tantanacushpa  
zirmataca mañana canchic.

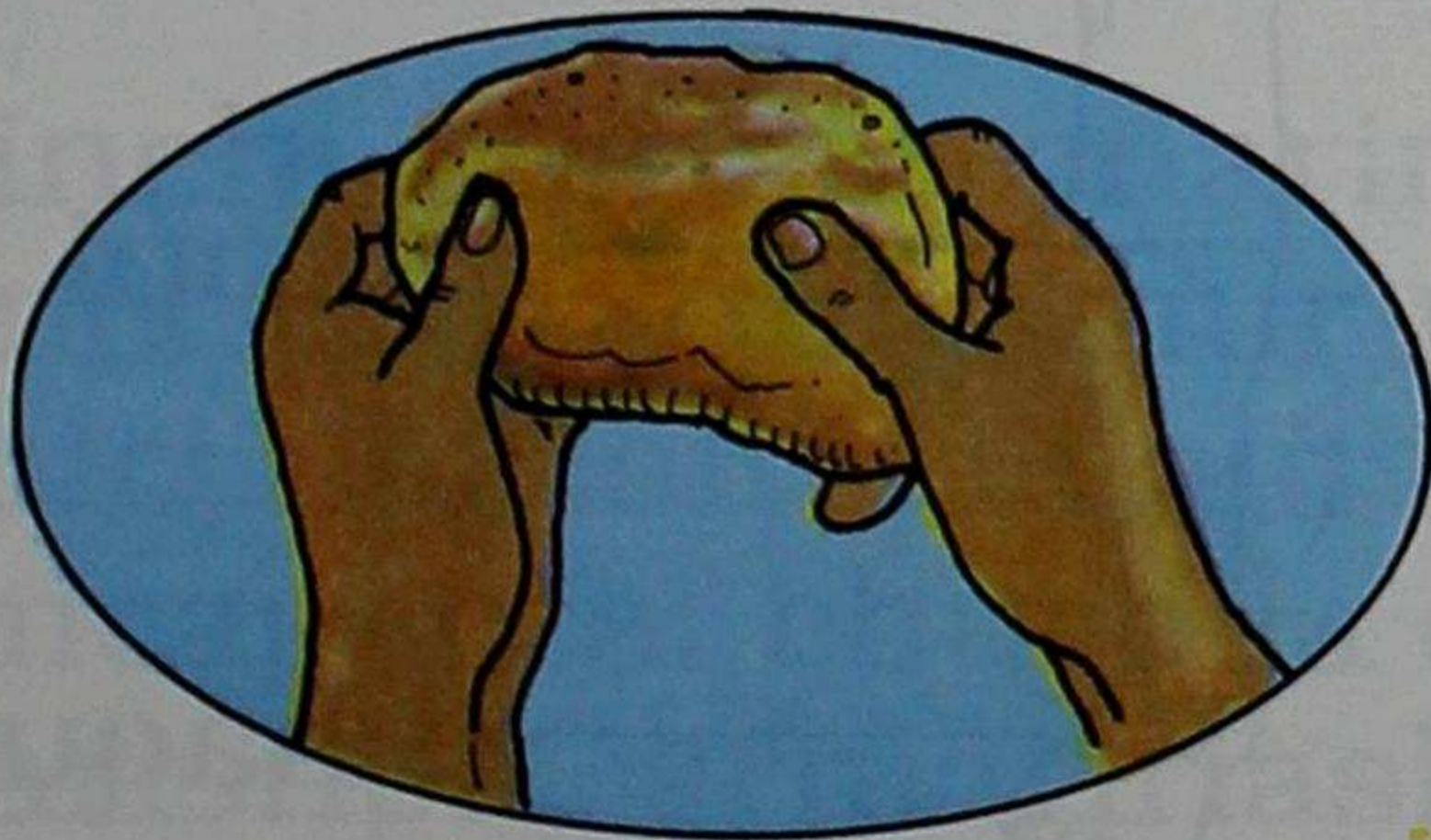
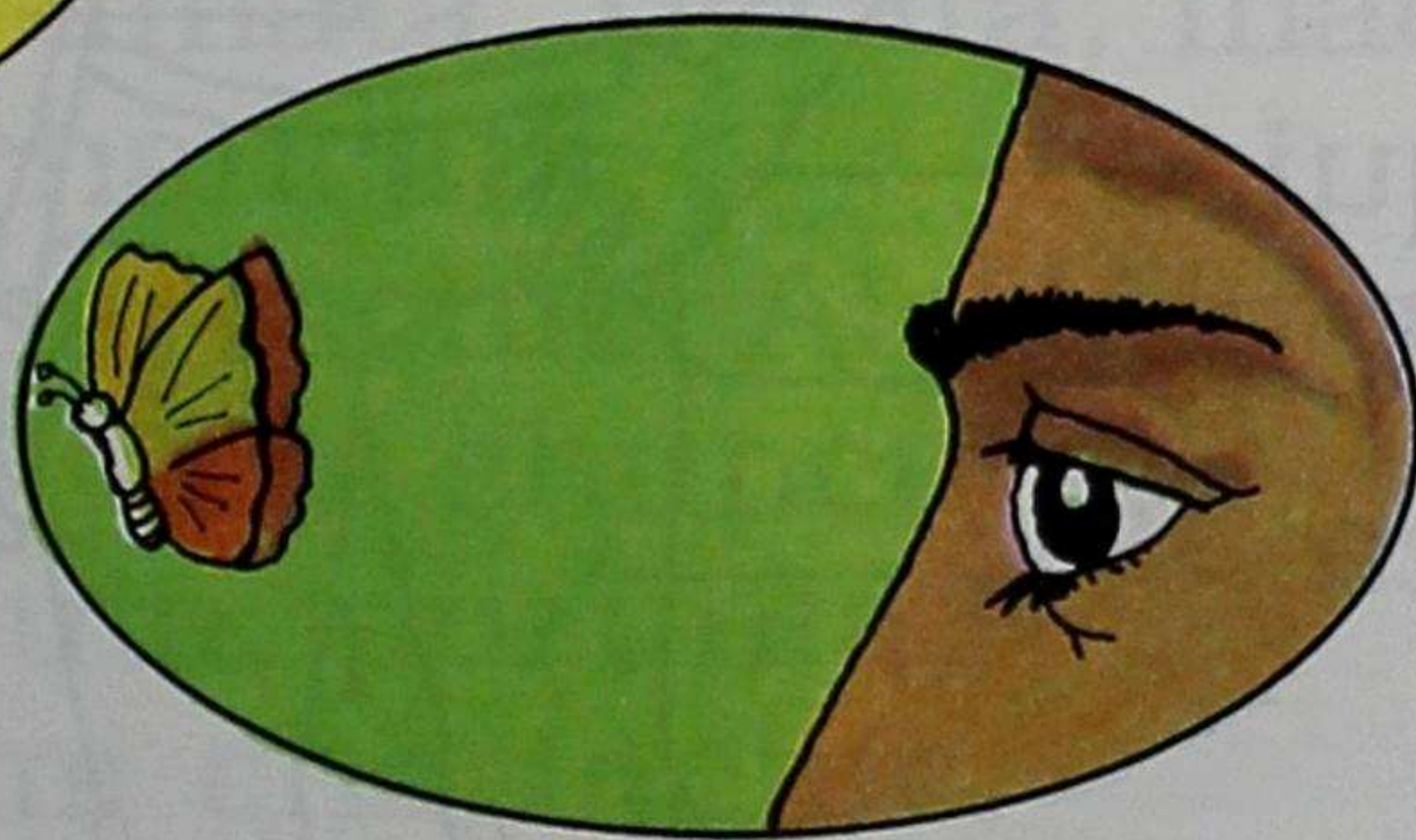
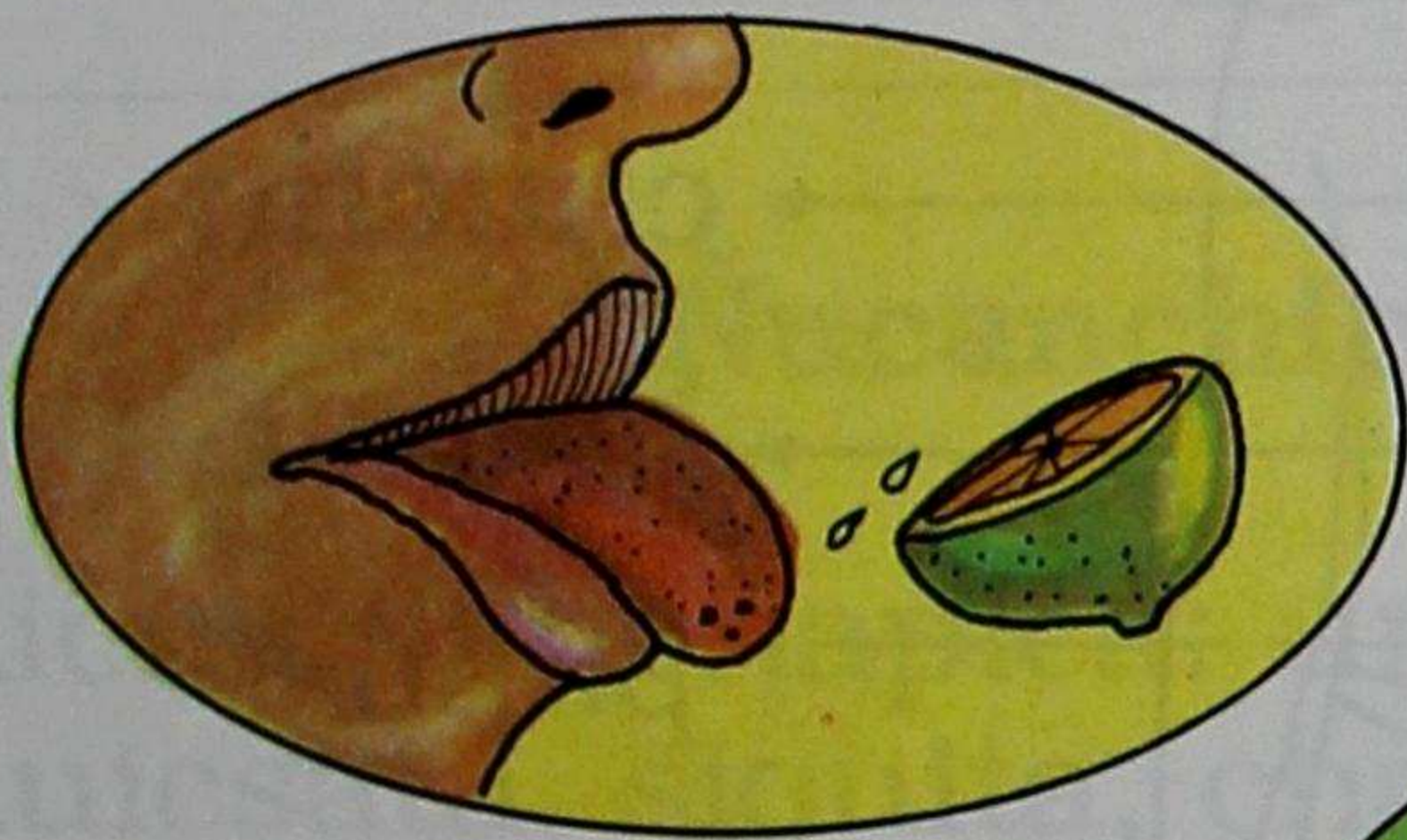
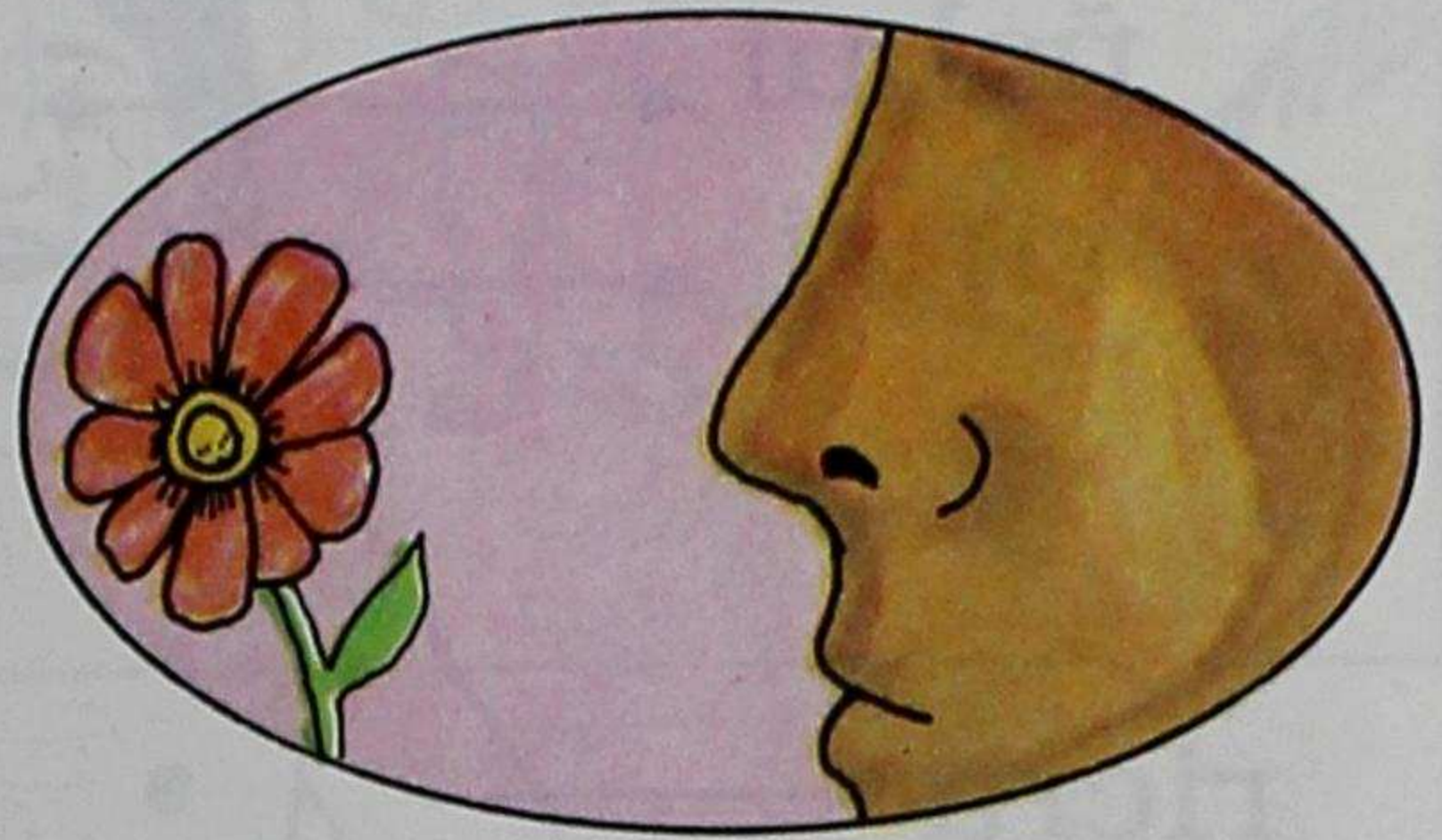
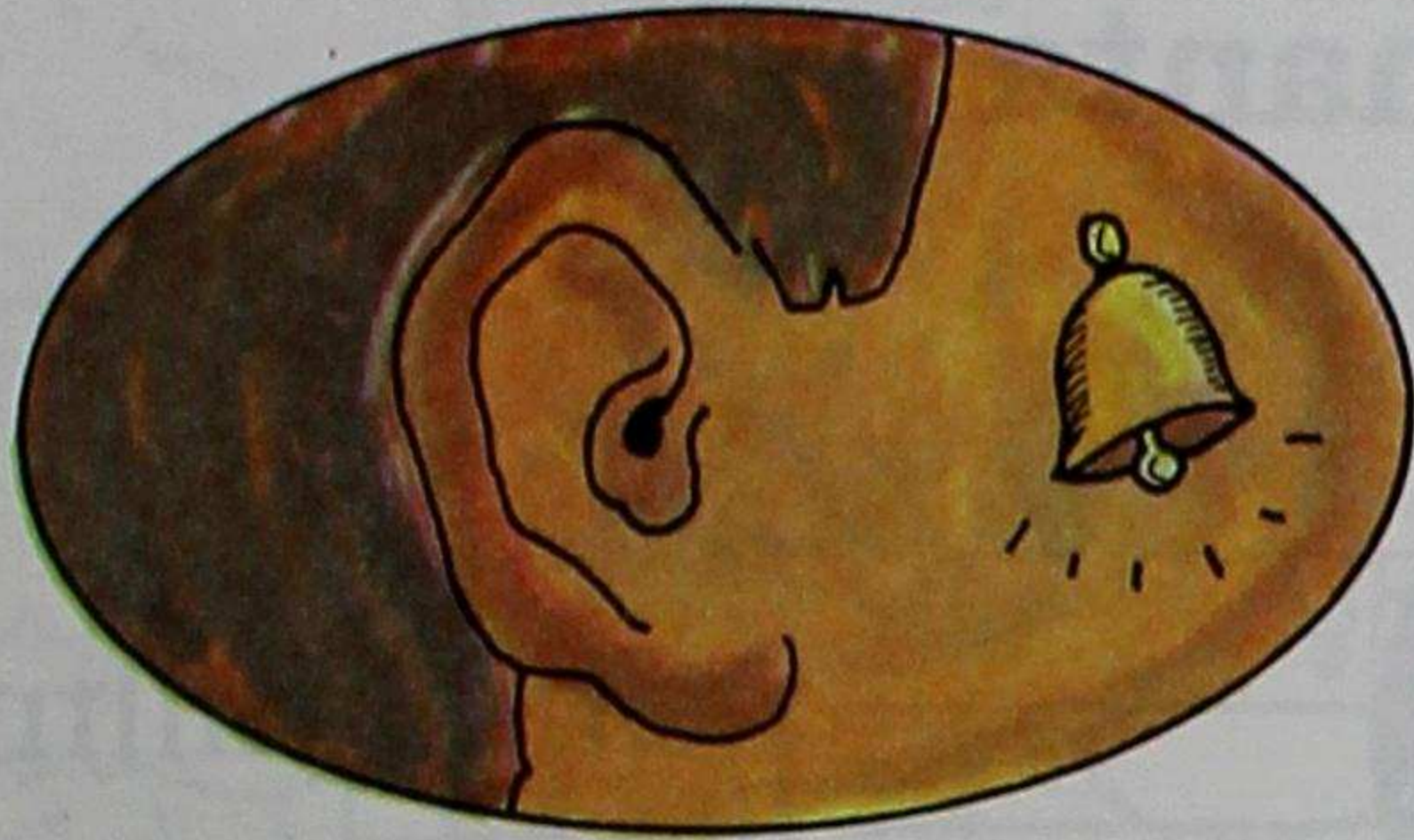
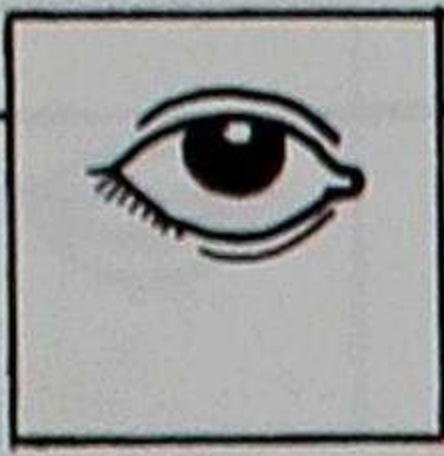

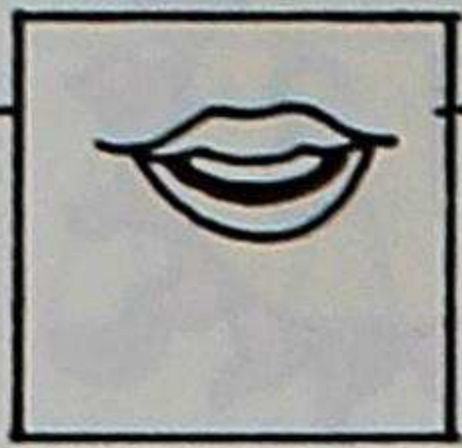

# Aichamanta

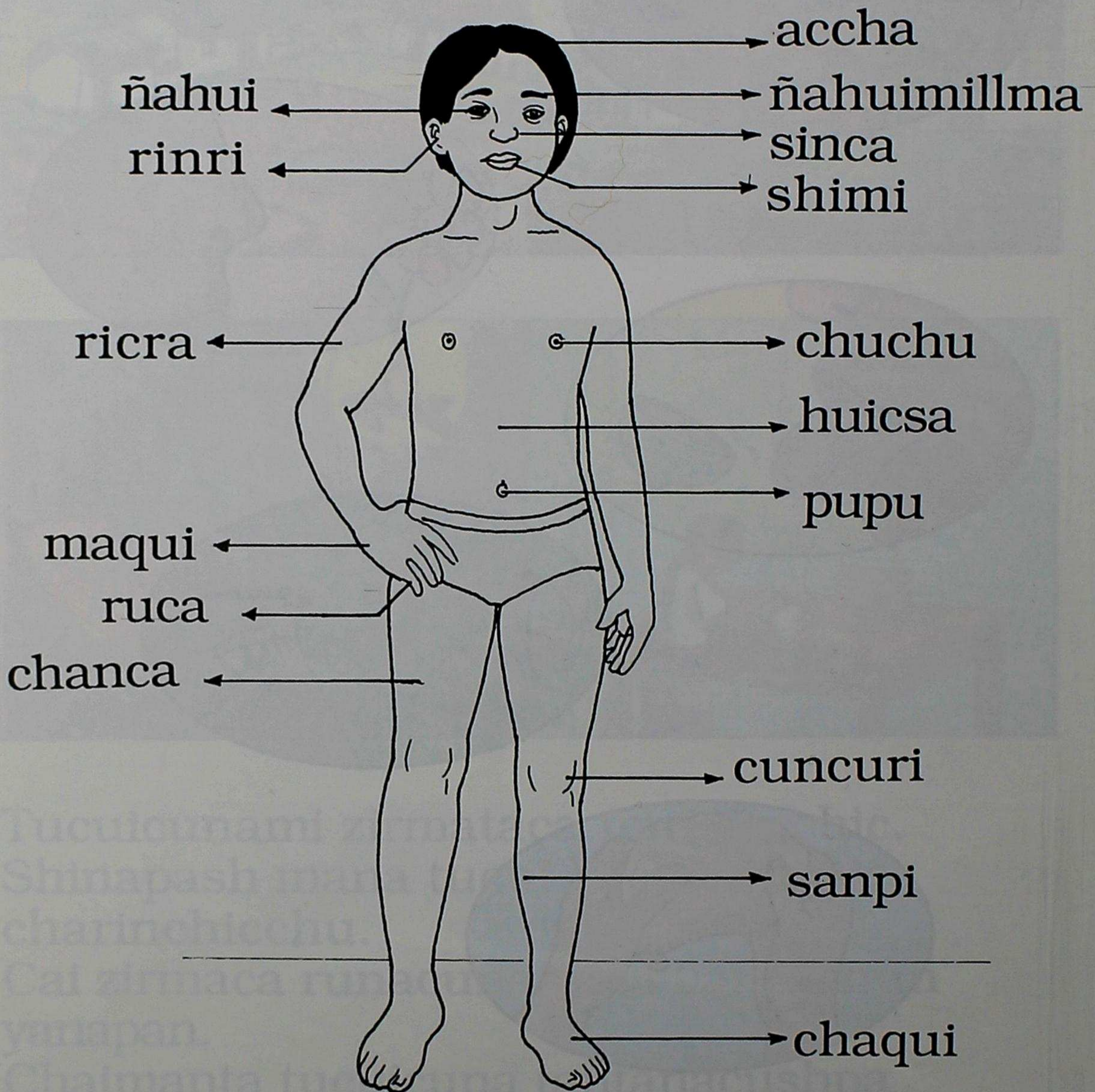



## Ñucanchic aichamanta

Aicha canchapica: umata, ricrata, maquita, huicsata, siquita, chancata, chaquitapashmi charinchic. Aicha ucupica: shuncuta, paructa, yana shuncuta, cantsata, ishpaperuta, puzunta, chunchullitapashmi charinchic.

Alli sinchi aichata charincapacca ñucanchic quiquin murucunatami micuna canchic; shinallatac alli causaitapash charincapacca: chuyalla churanacunata churarishpa, armaririshpapashmi causana canchic.



# Huashamanta

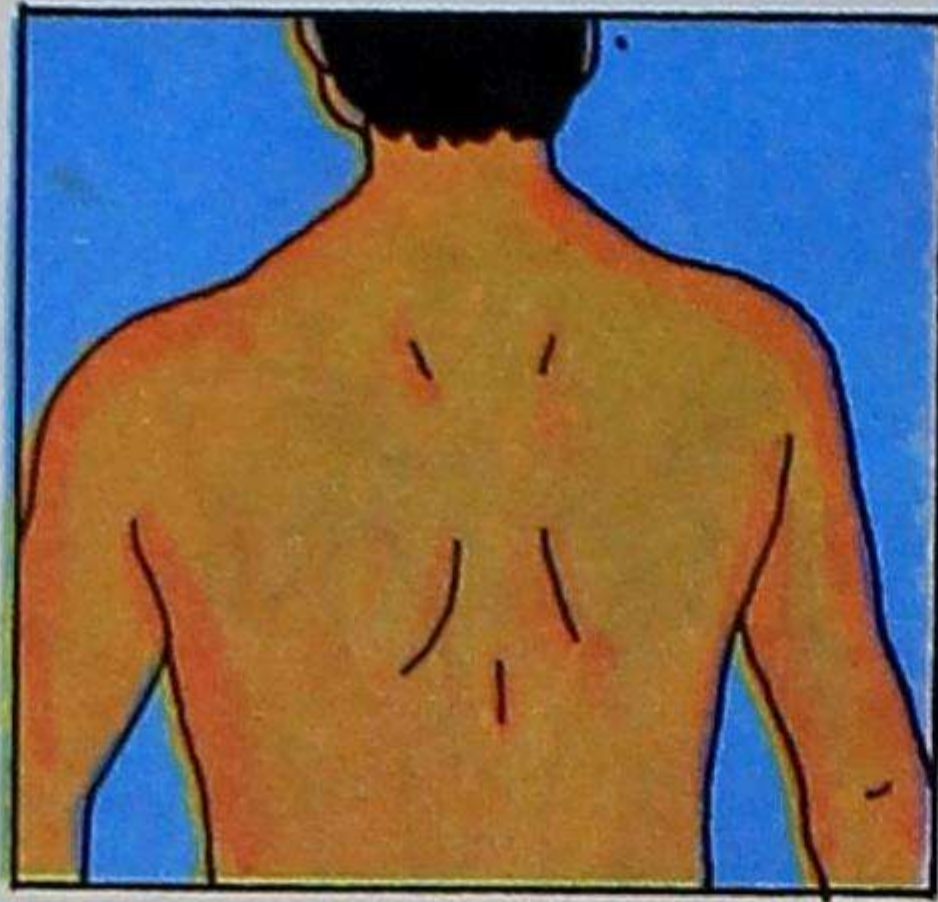

huasha

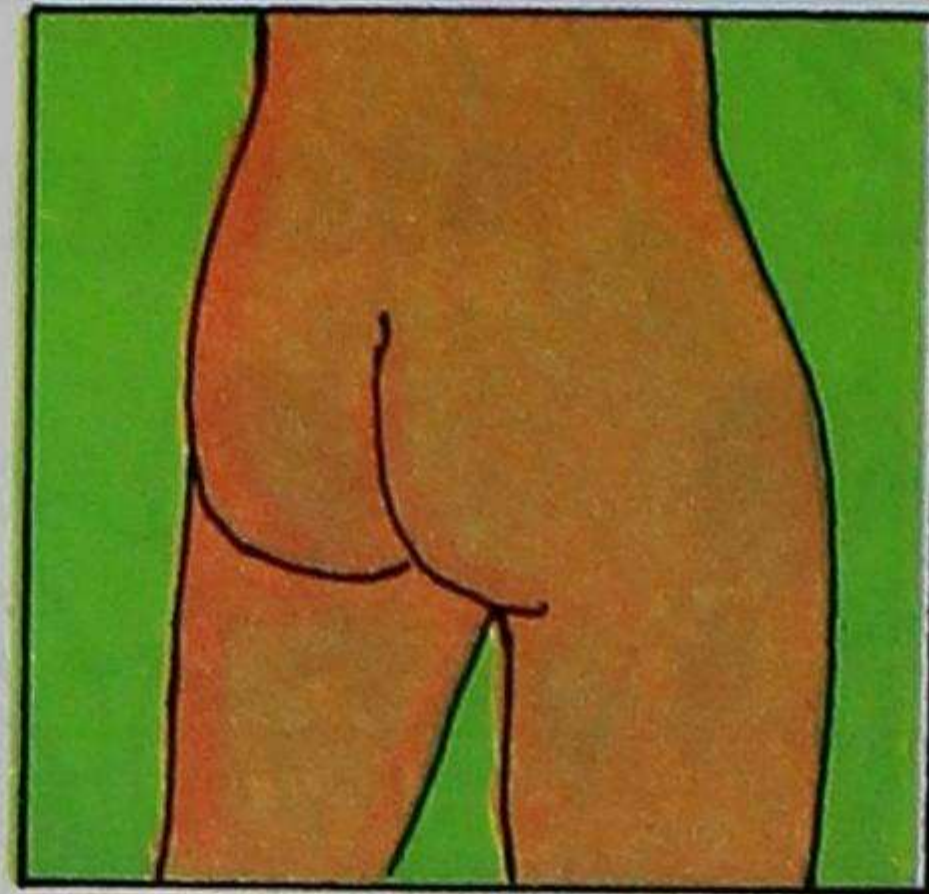

siqui

# Millmamanta

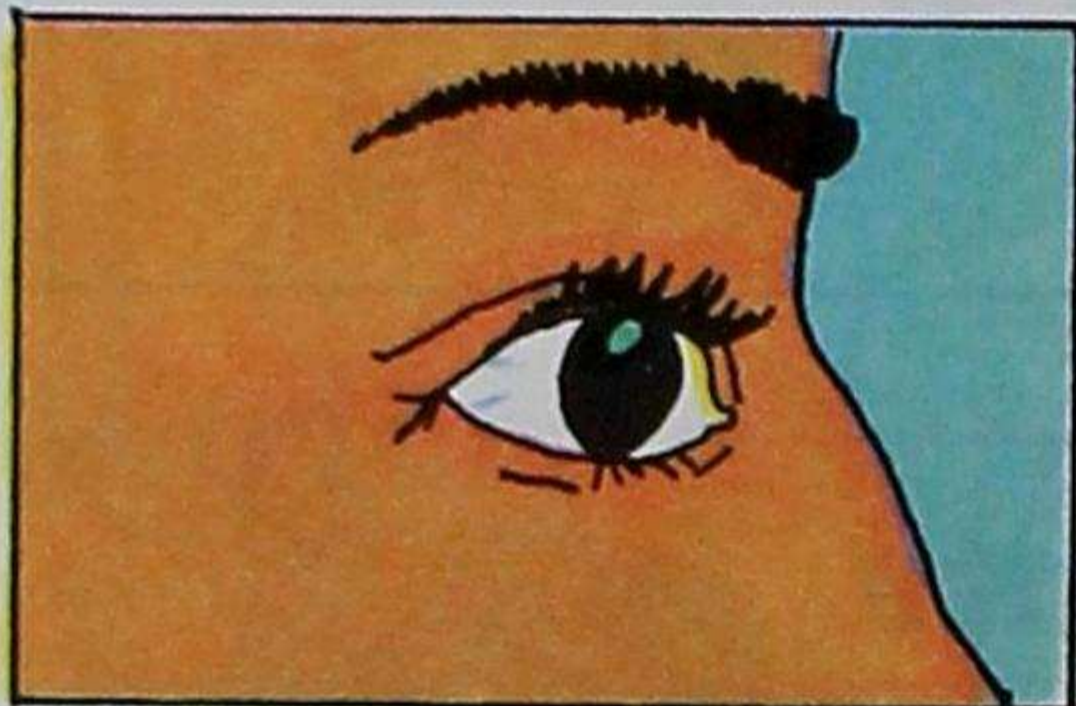

ñahui millma

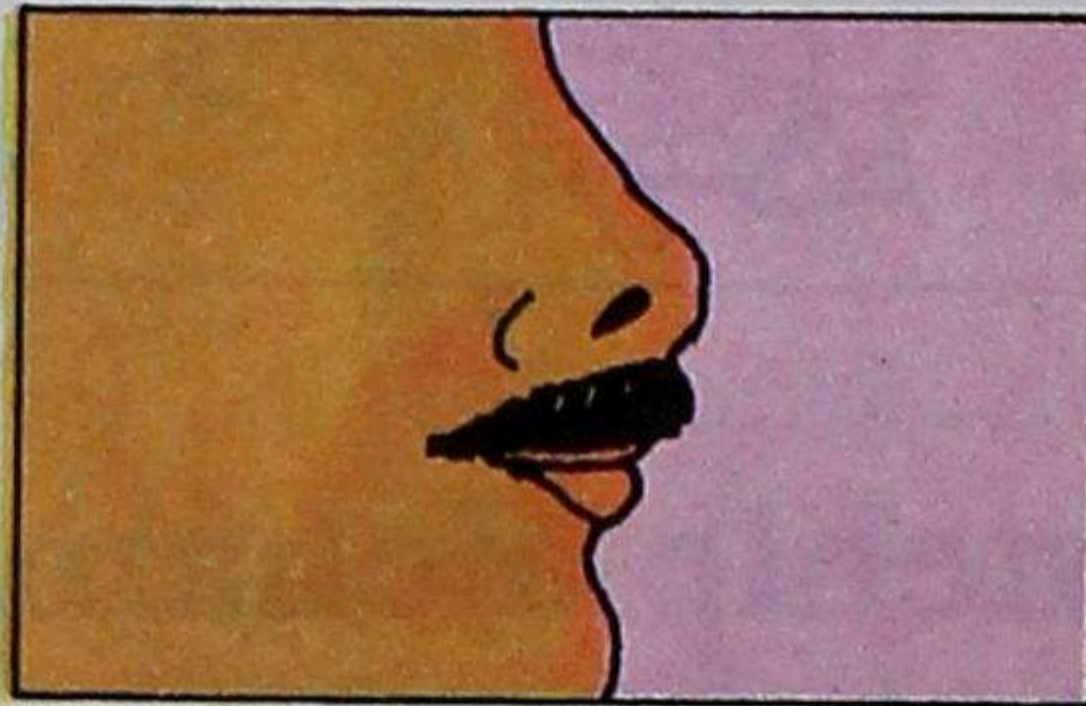

shimi millma

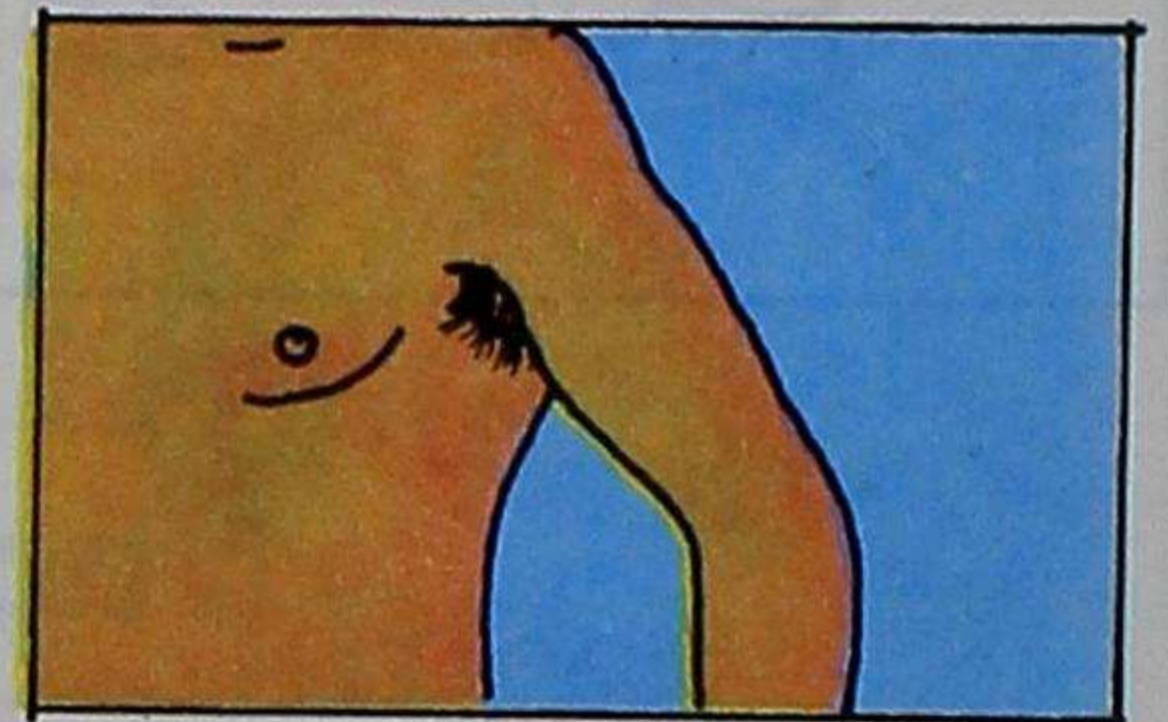

ricra millma

# Utcumanta

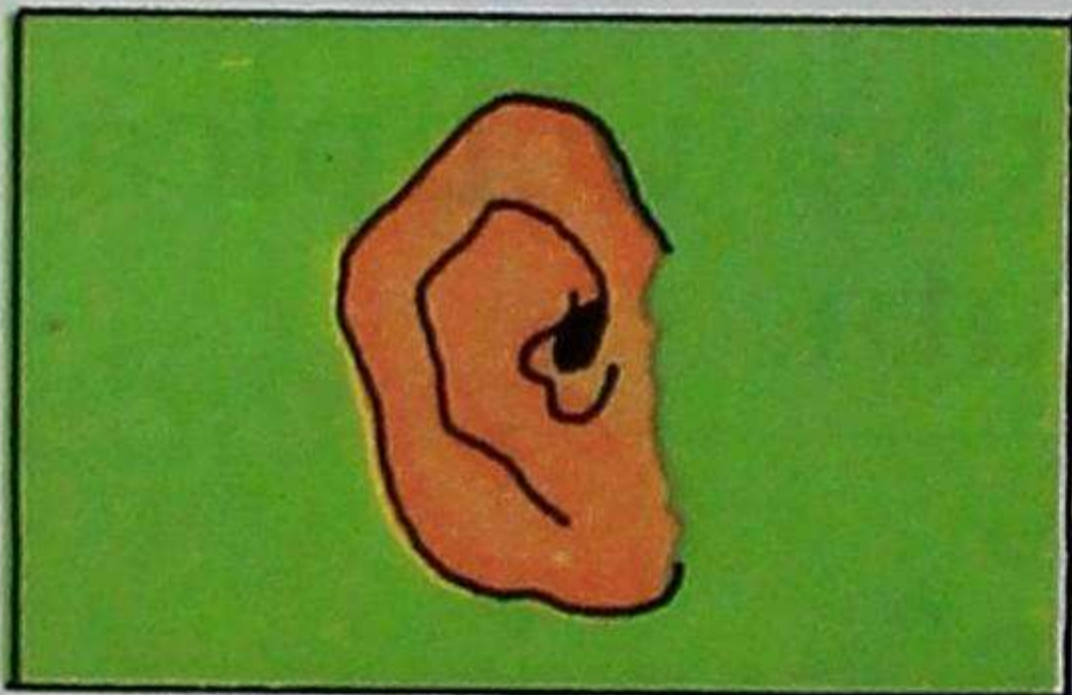

rinri utcu

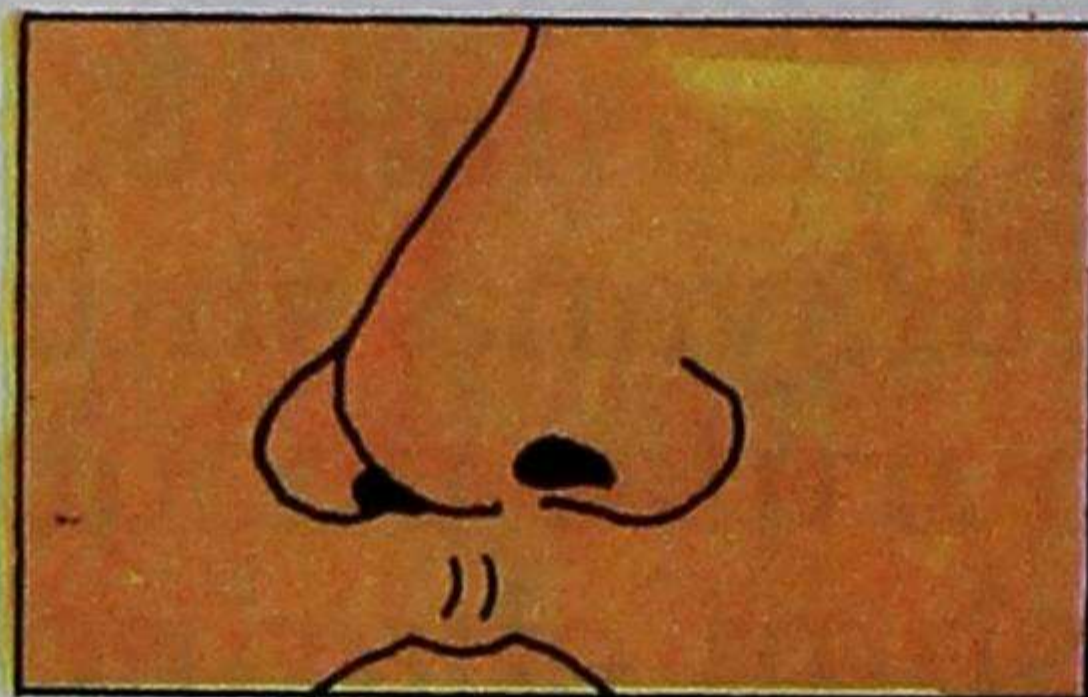

sinca utcu

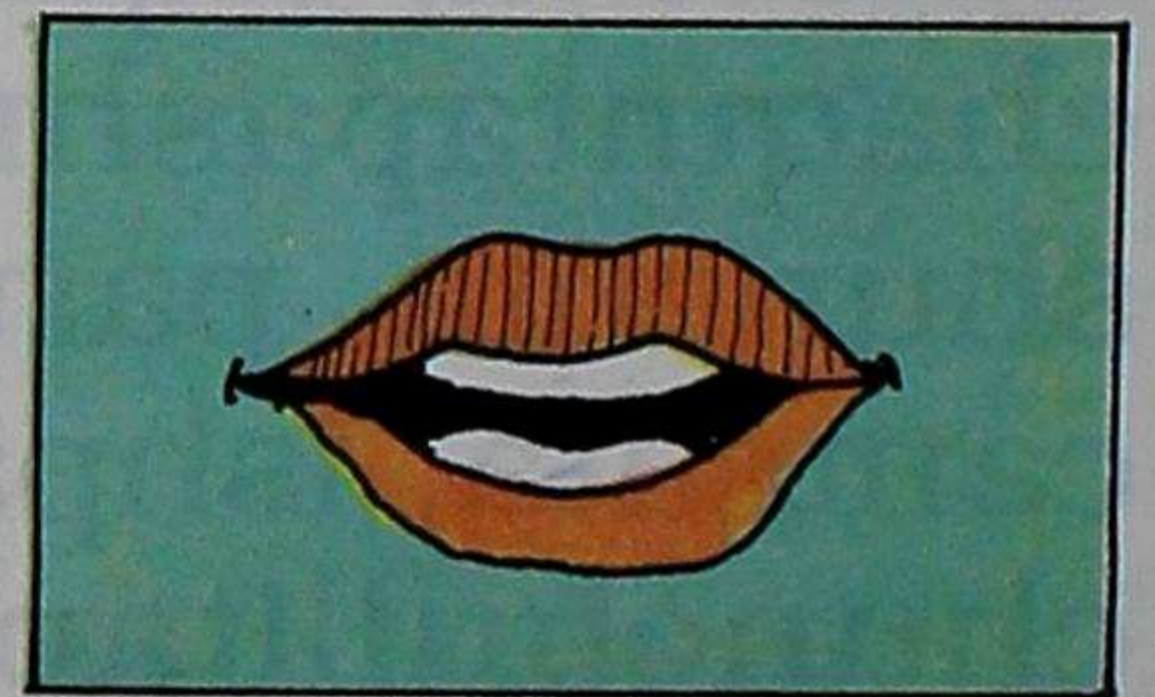

shimi utcu

# Mucumanta



maqui  
mucu

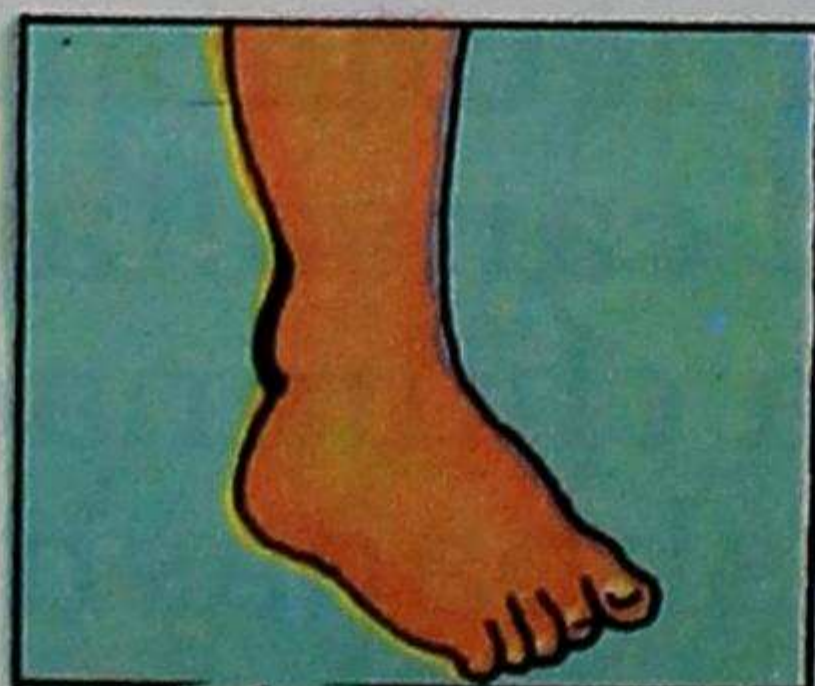

chaqui  
mucu

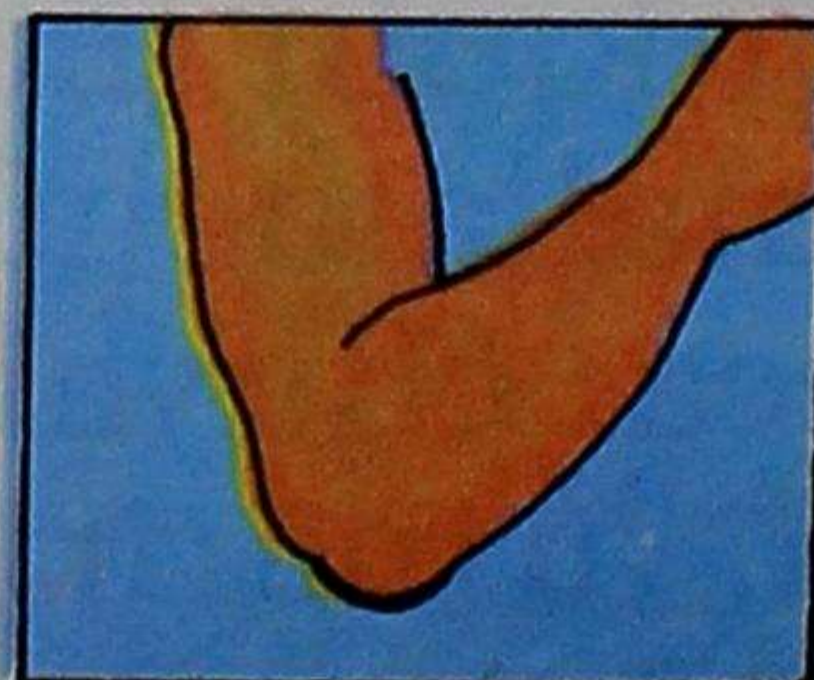

ricra  
mucu



ruca mucu

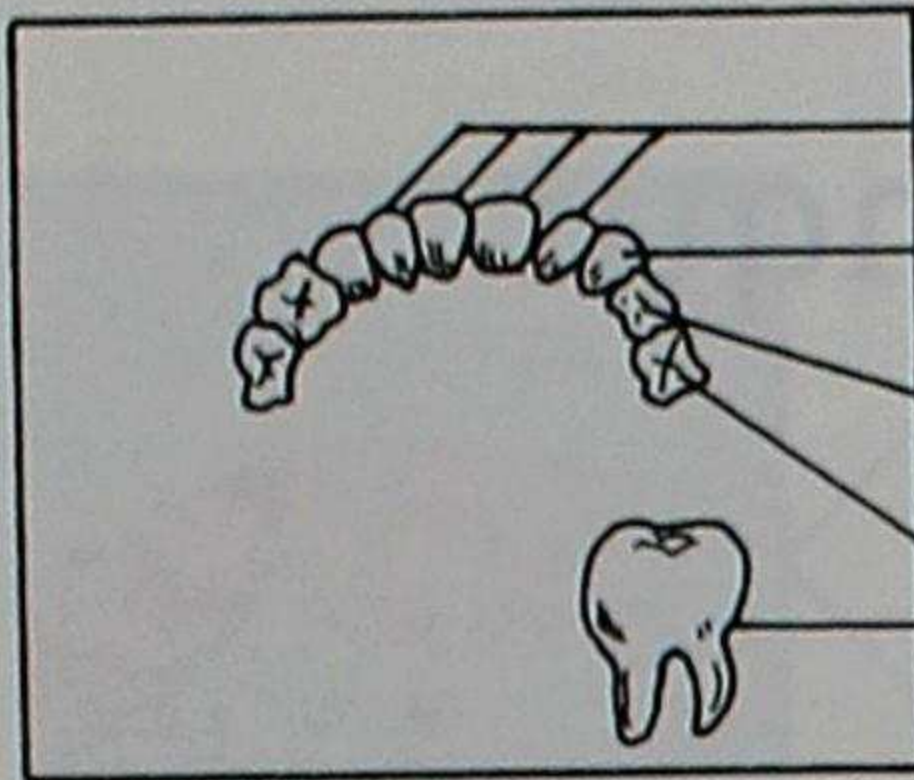
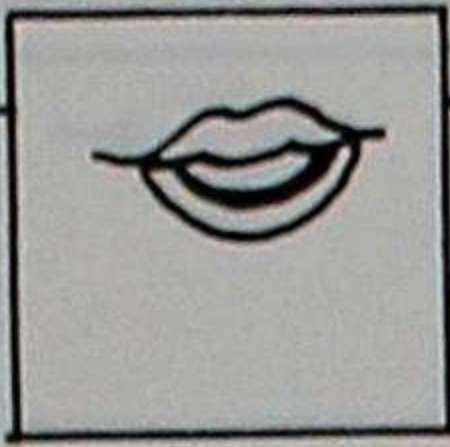

ñaupa  
 quiru  
 allcu  
 quiru  
 racu quiru  
 mama quiru

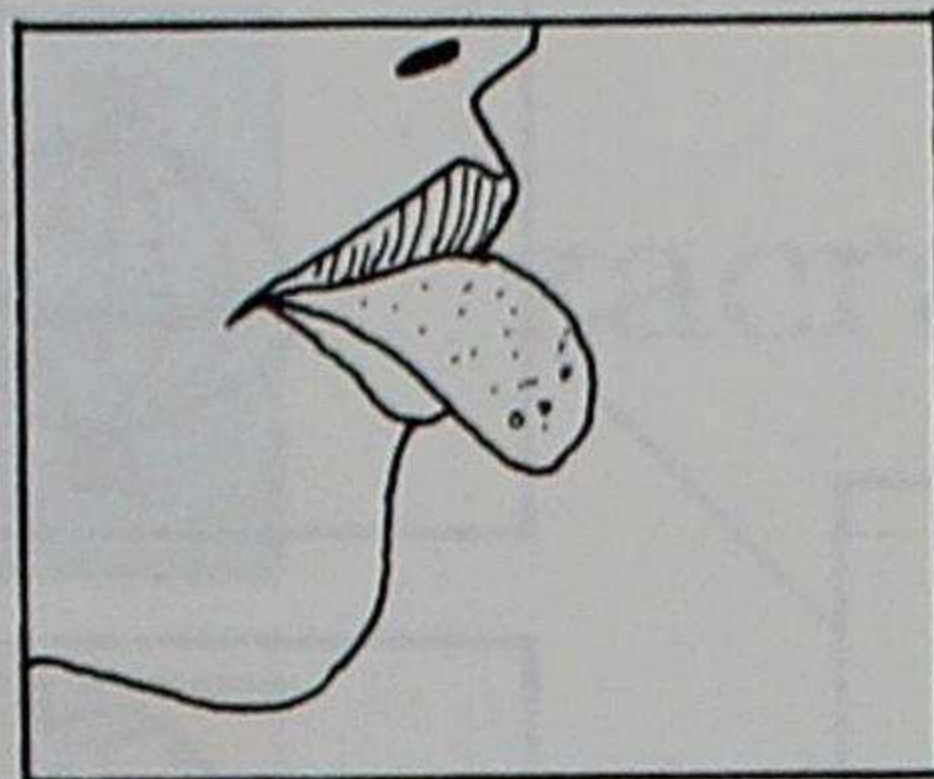

callu

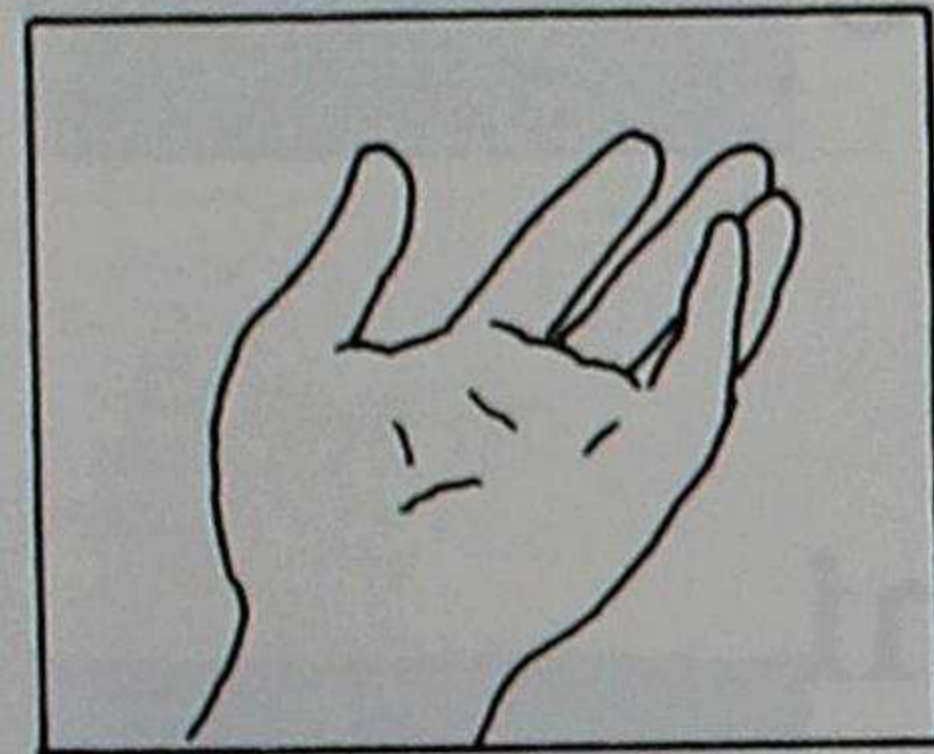

maqui shuncu

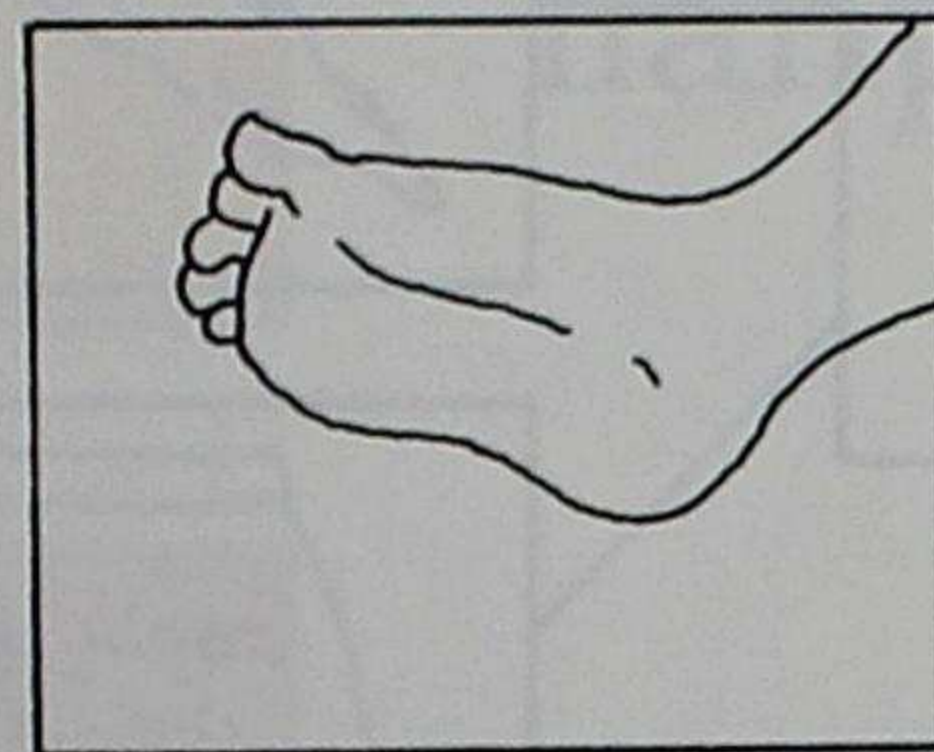

chaqui shuncu

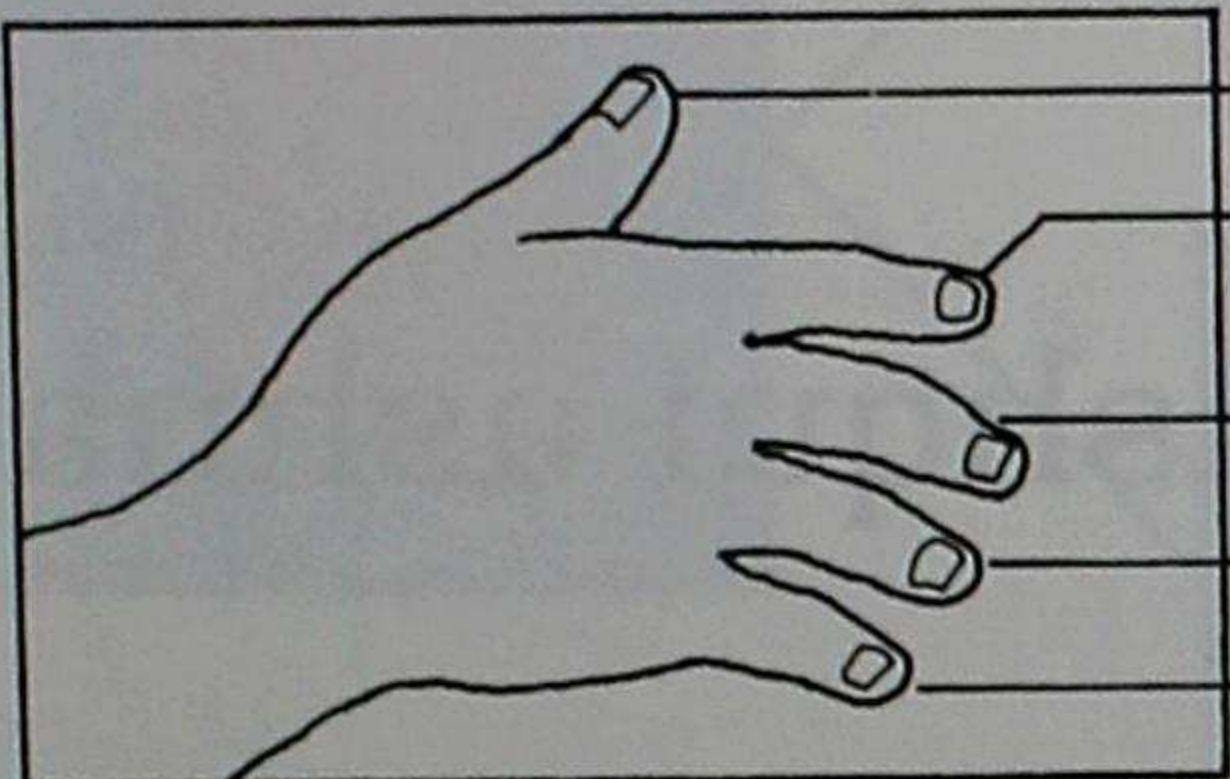

mama ruca  
 ricuchic ruca  
 shuncu ruca  
 shihui ruca  
 huahua ruca

racu ruca  
 chaupi ruca  
 huahua ruca

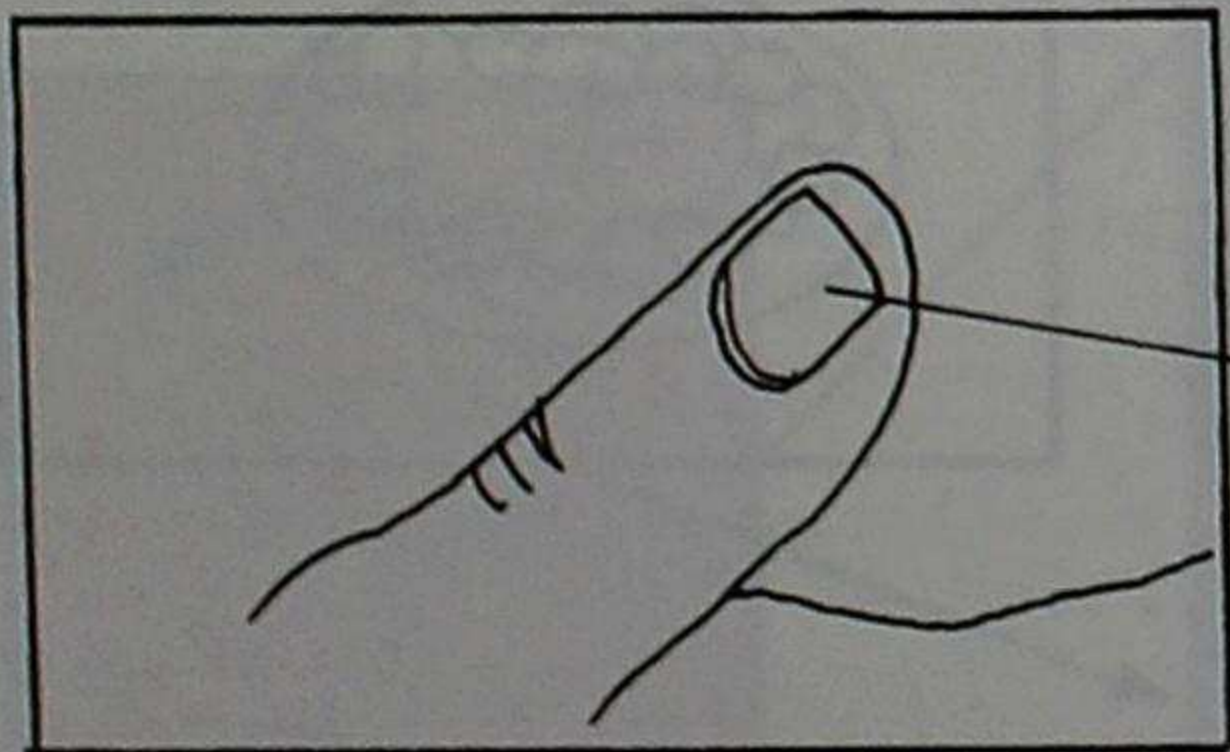
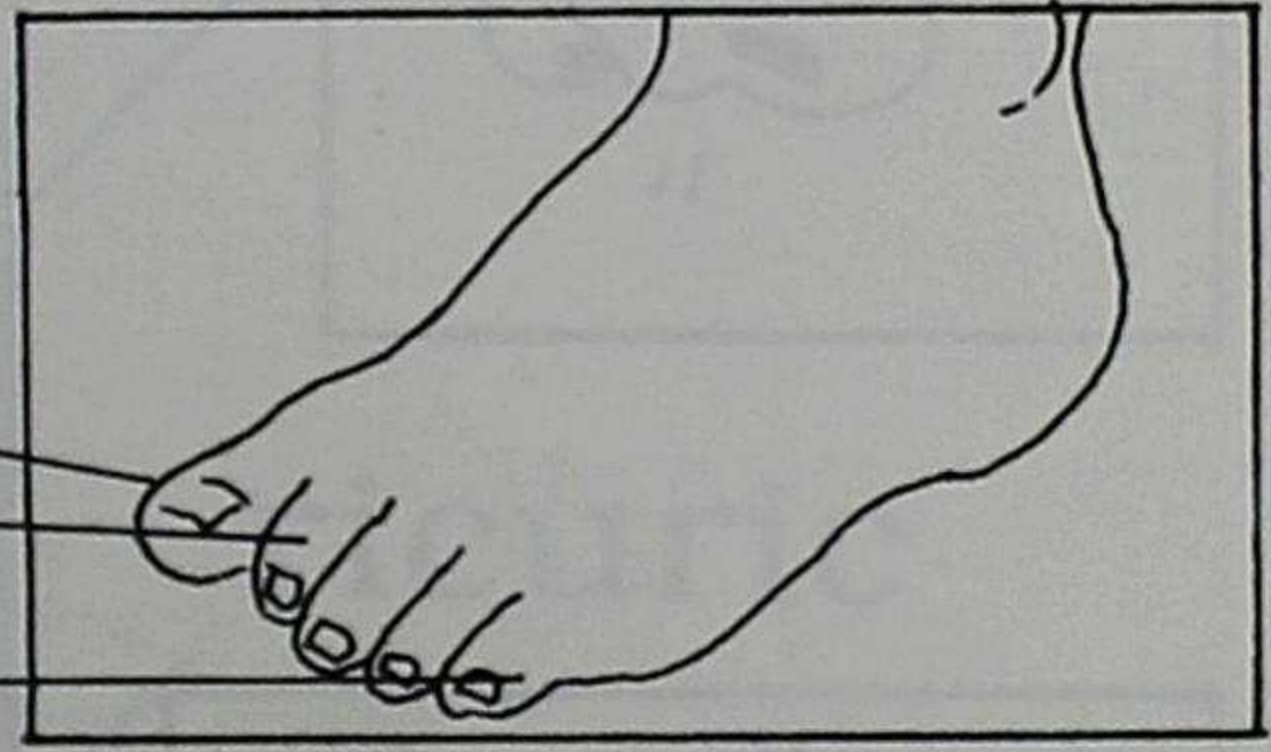

sillu

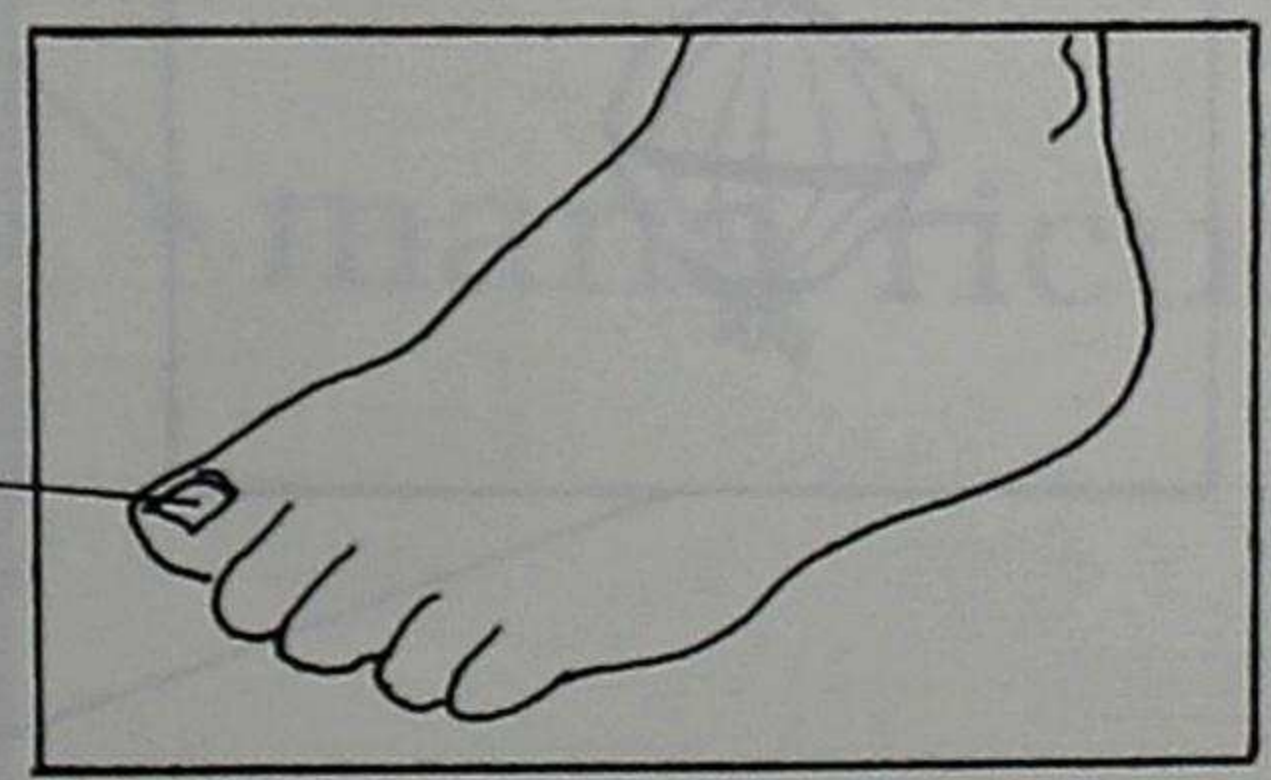

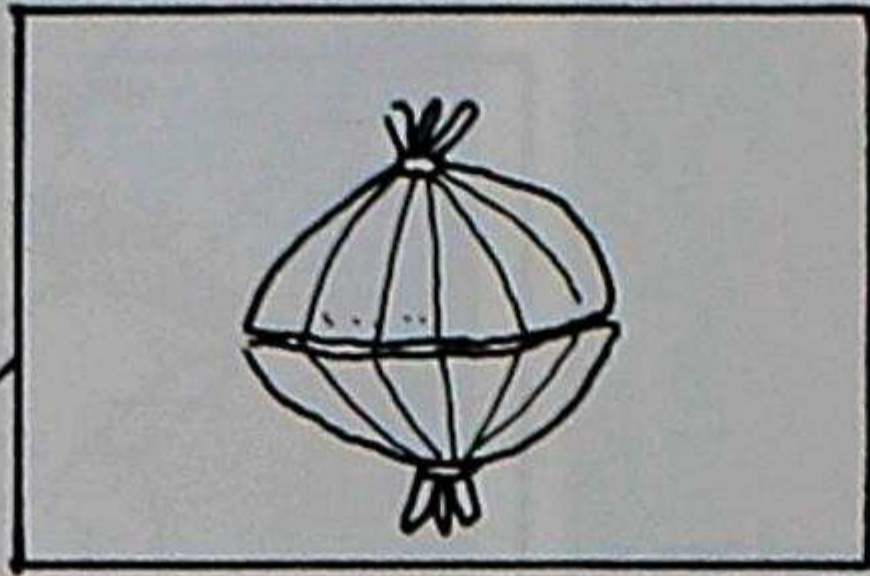
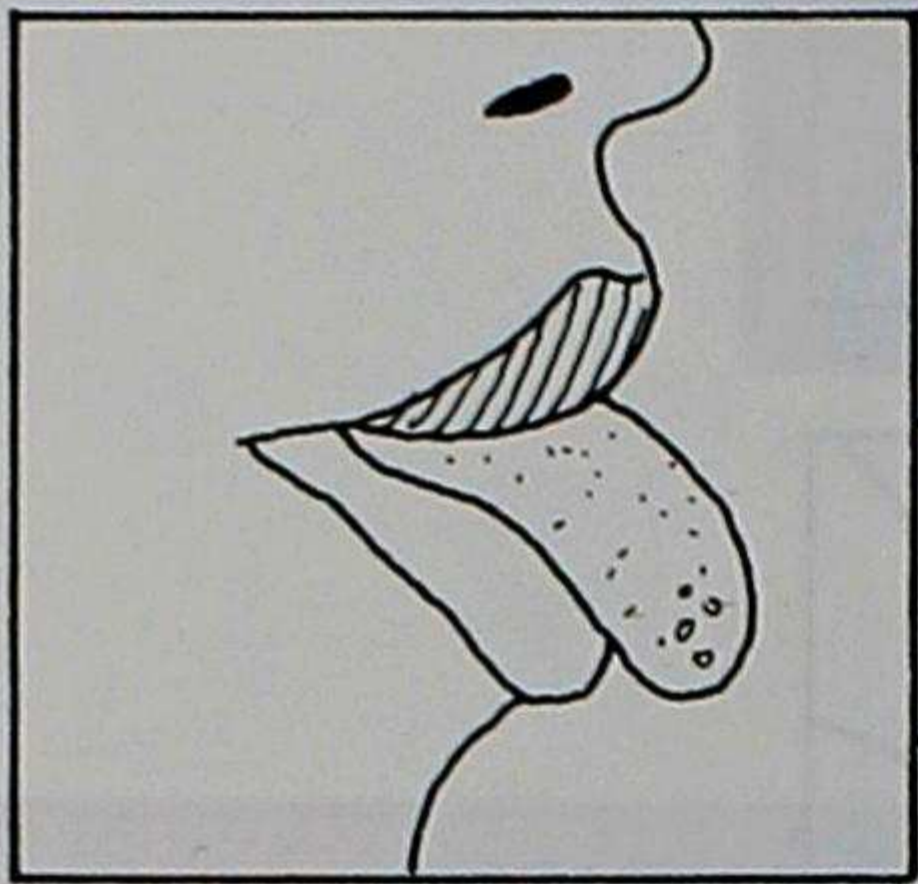
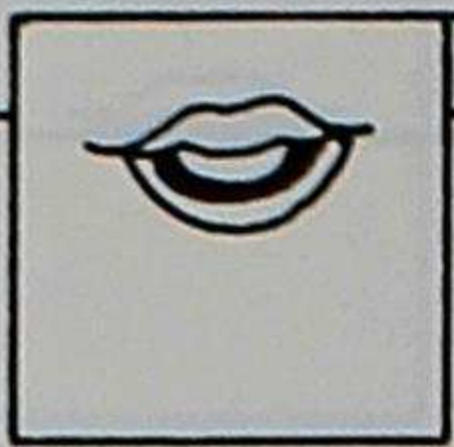

mishqui

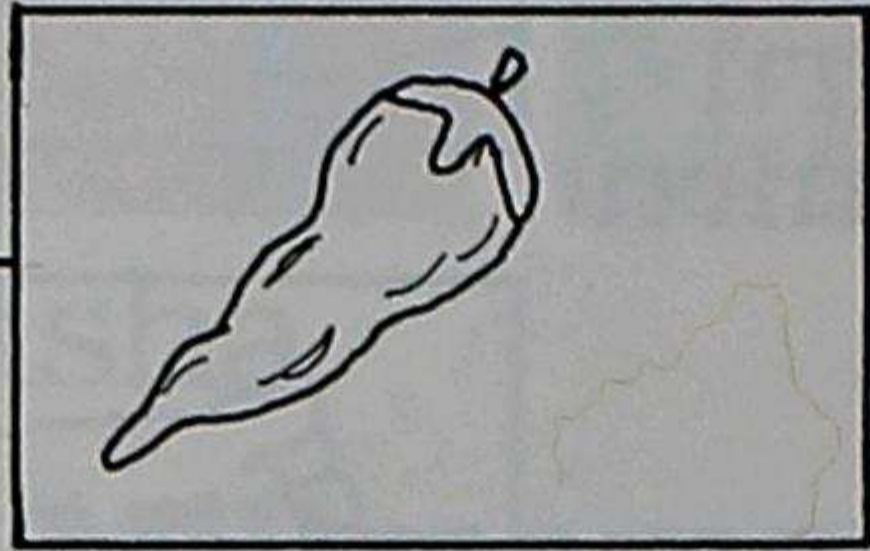

jayac

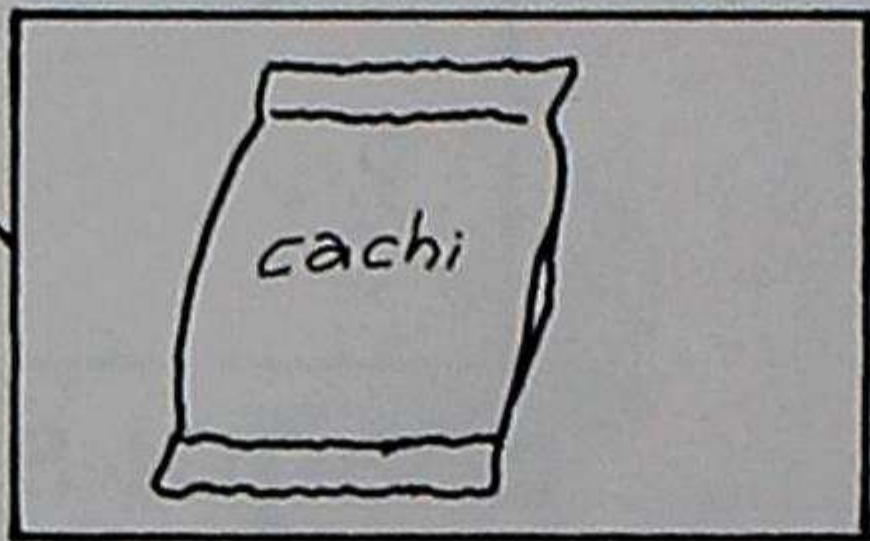

cachi

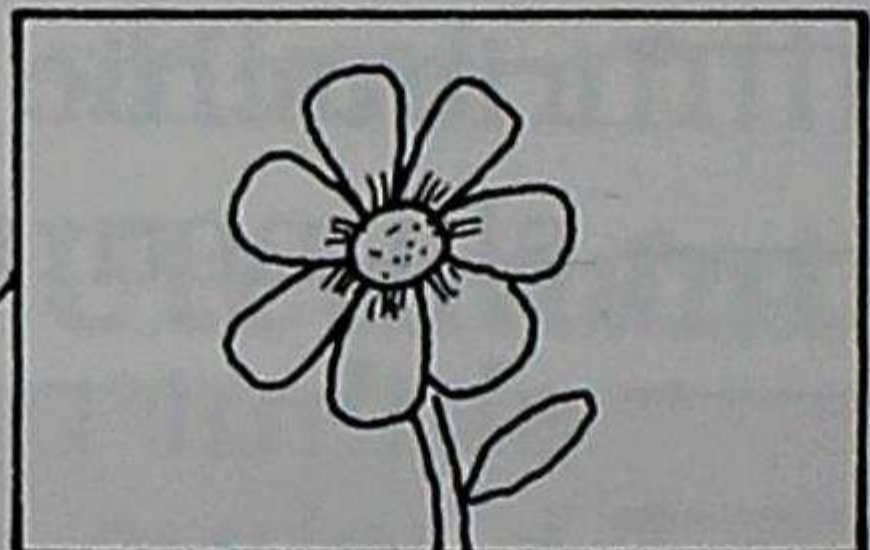
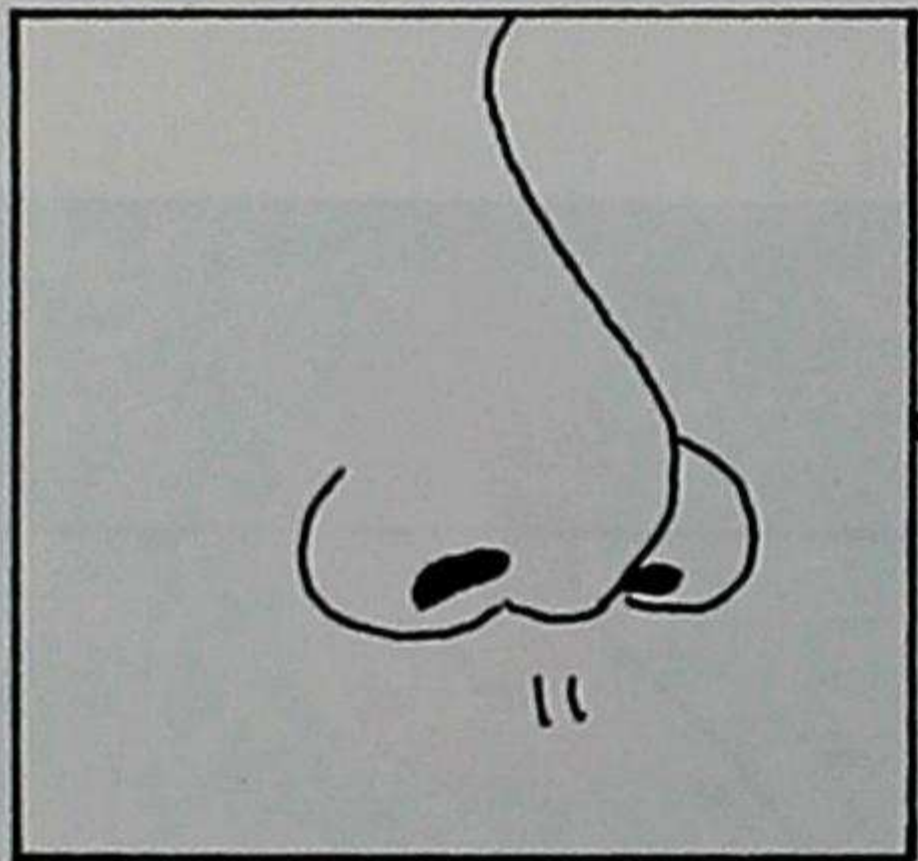

mishqui ashnac

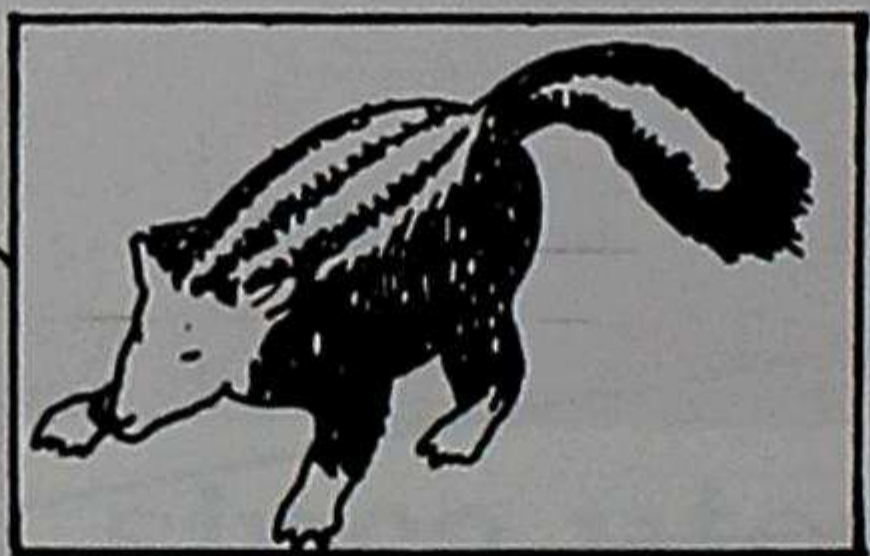

ashnac

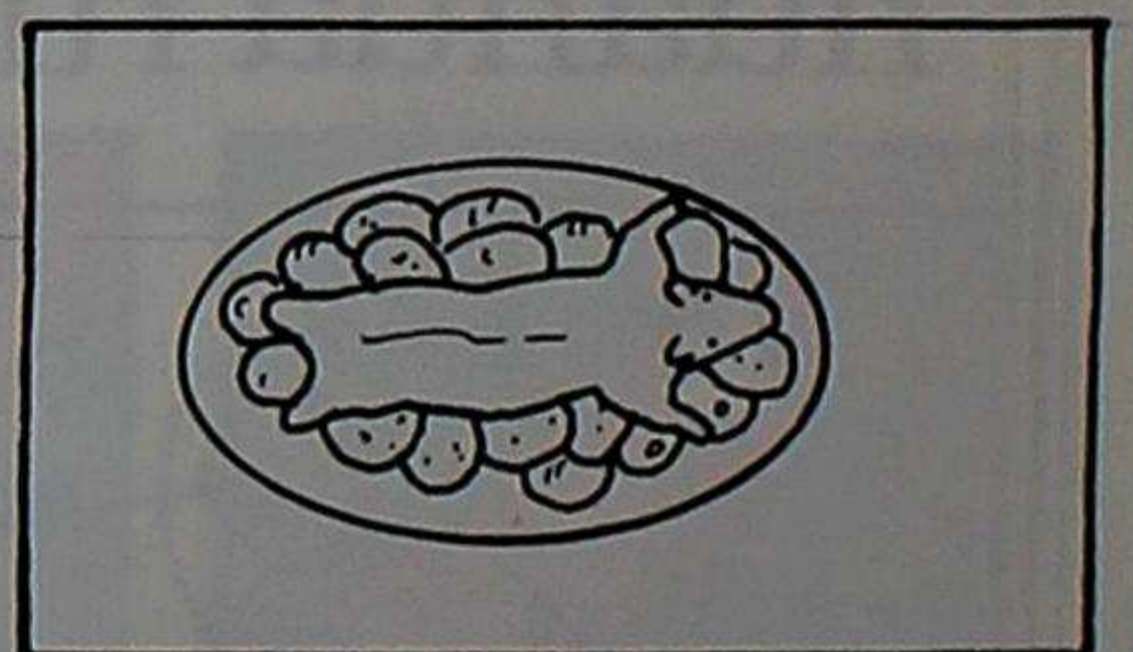
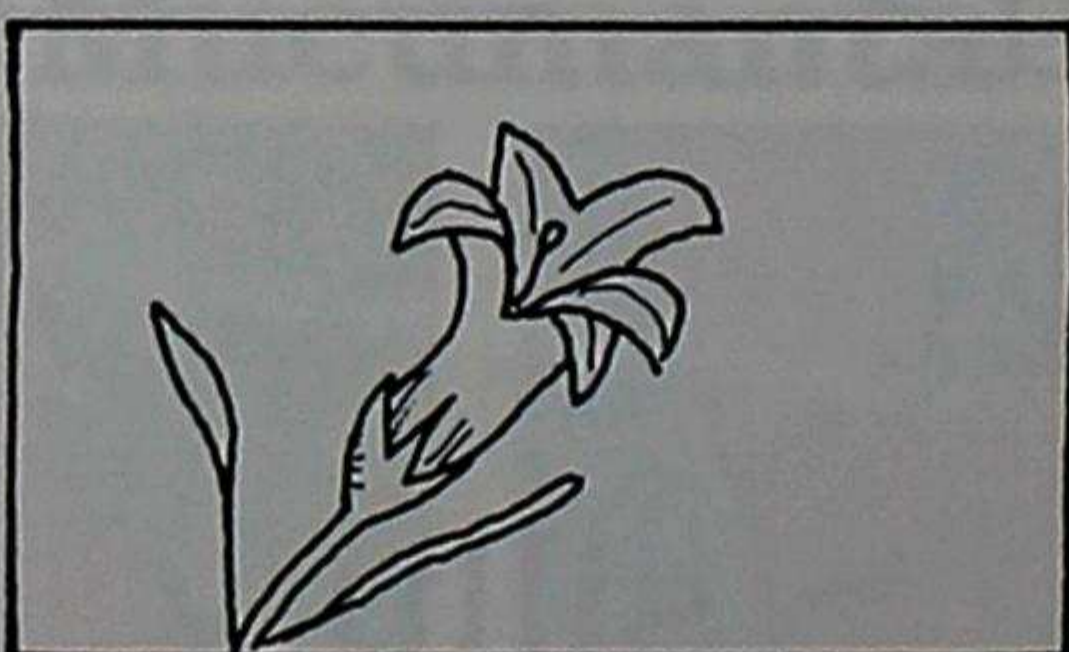
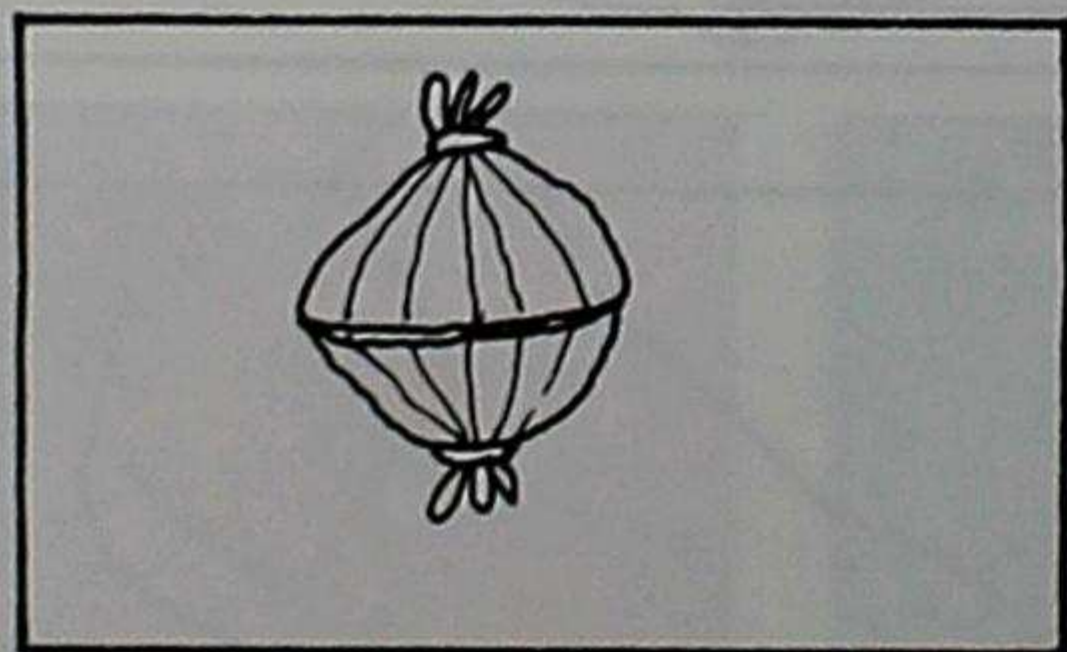

mishqui

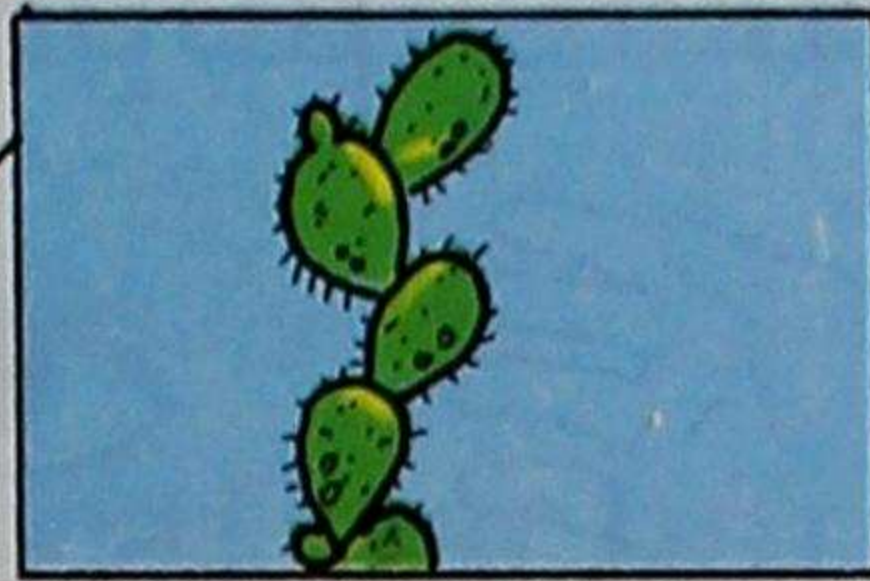
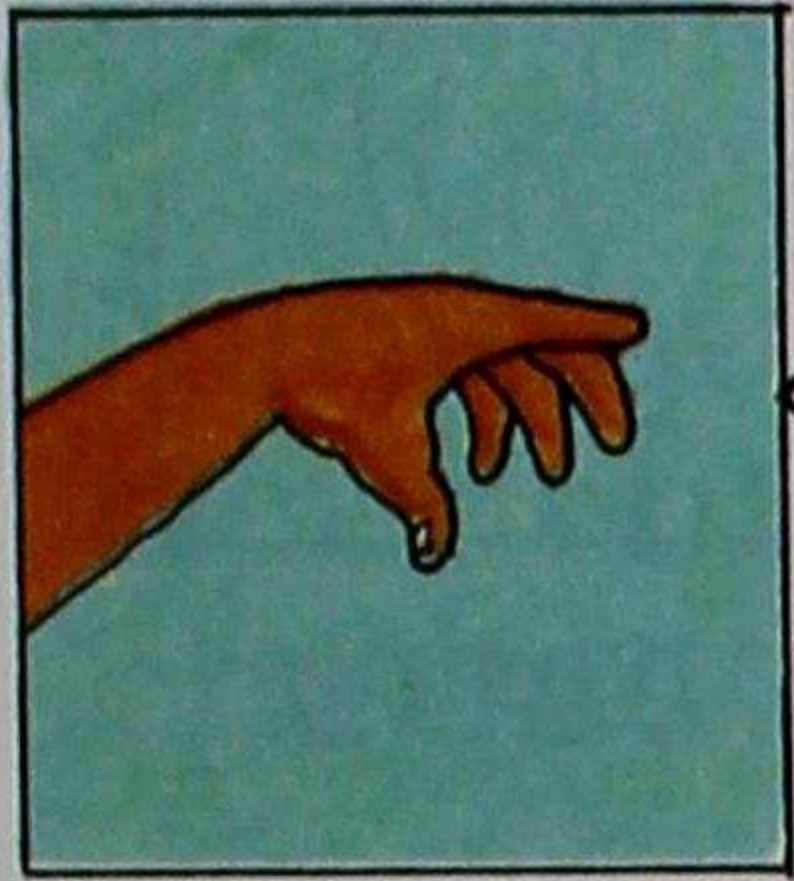
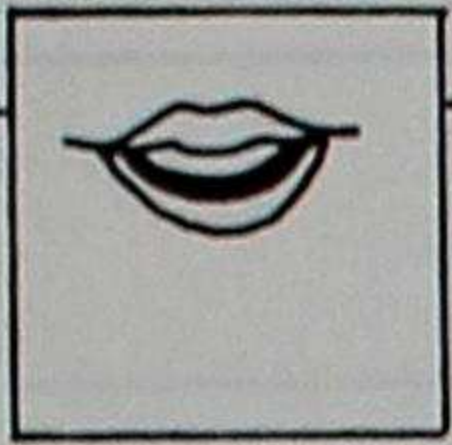

zacra

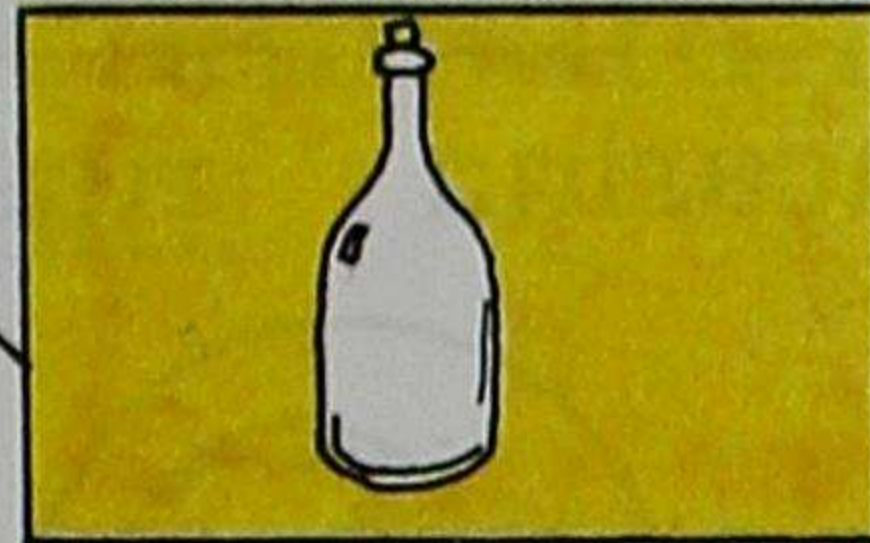

llanpu



uyari



mana uyari

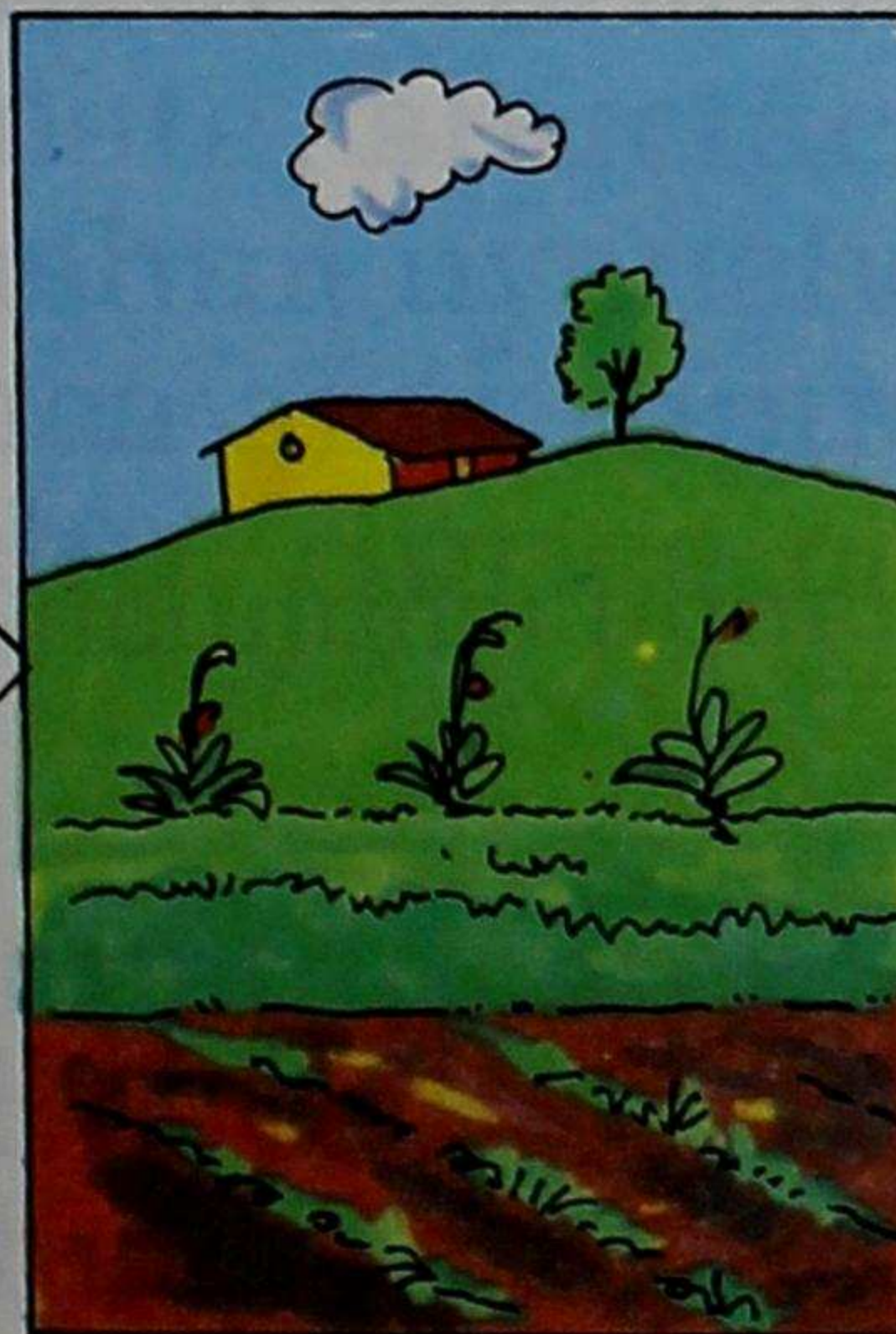
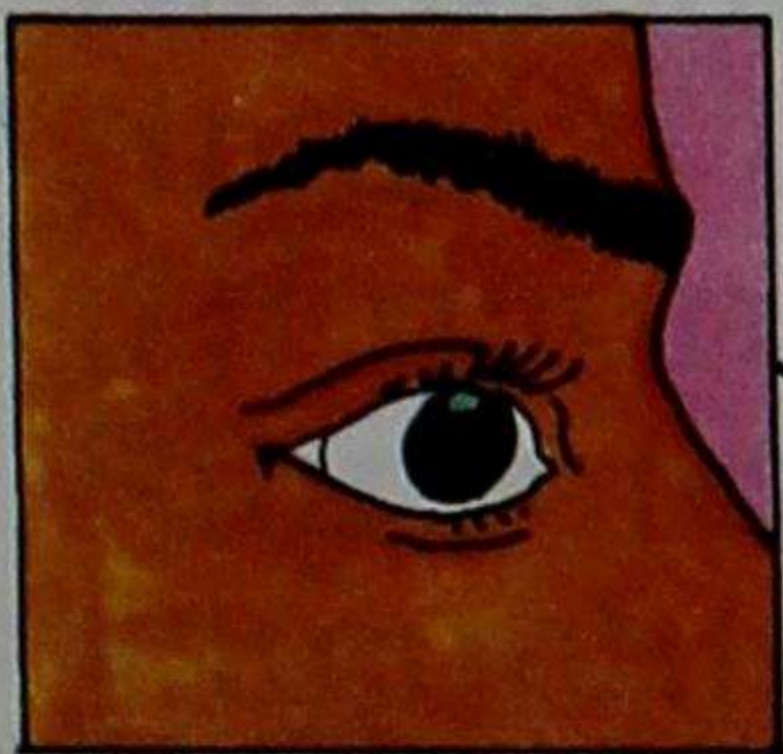

ricuric

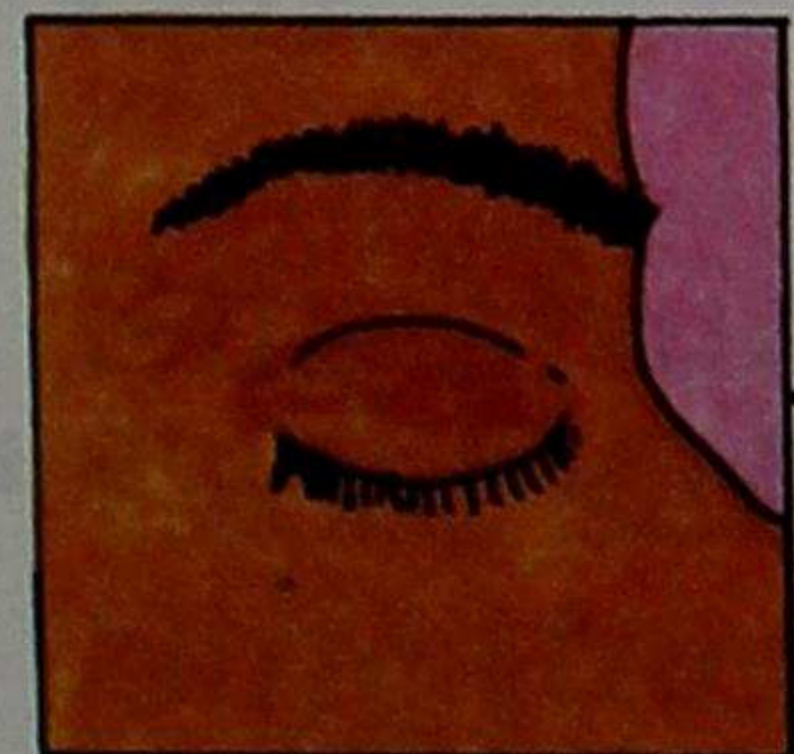

mana ricuric



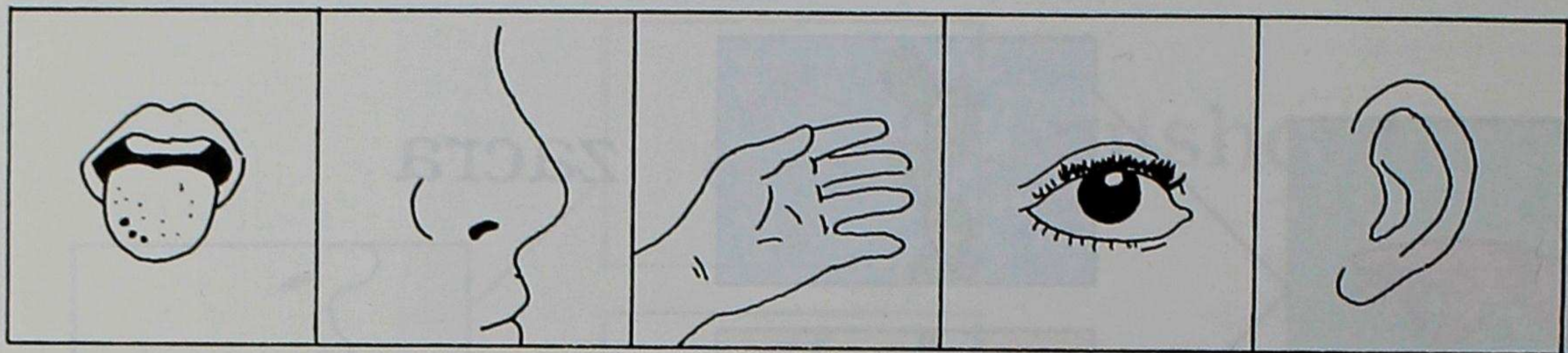
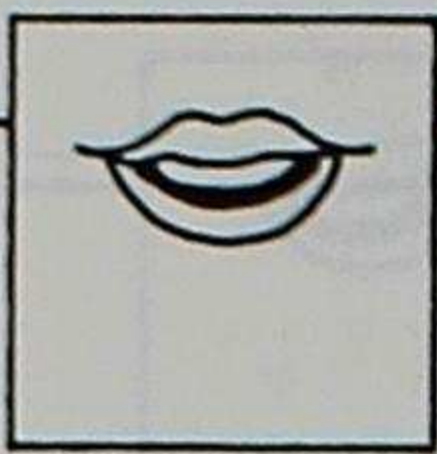

mallina

mutquina

tacarina

ricuna

uyarina

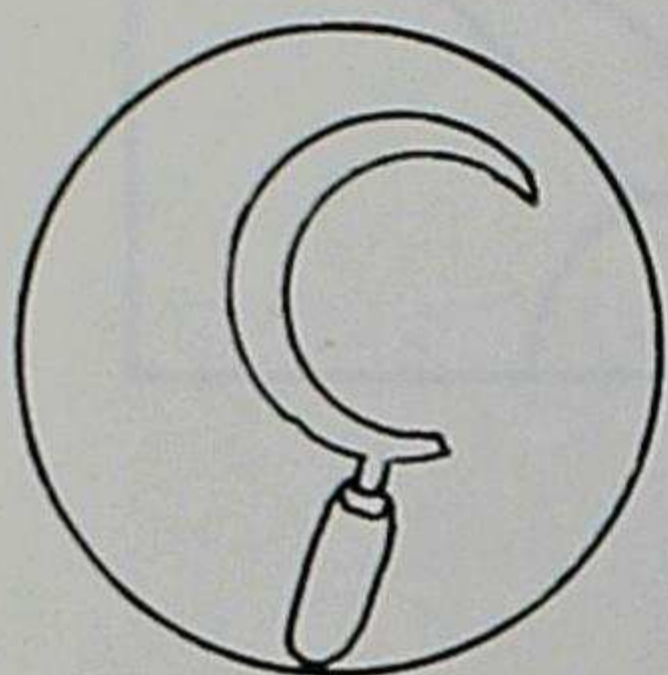

llanpu

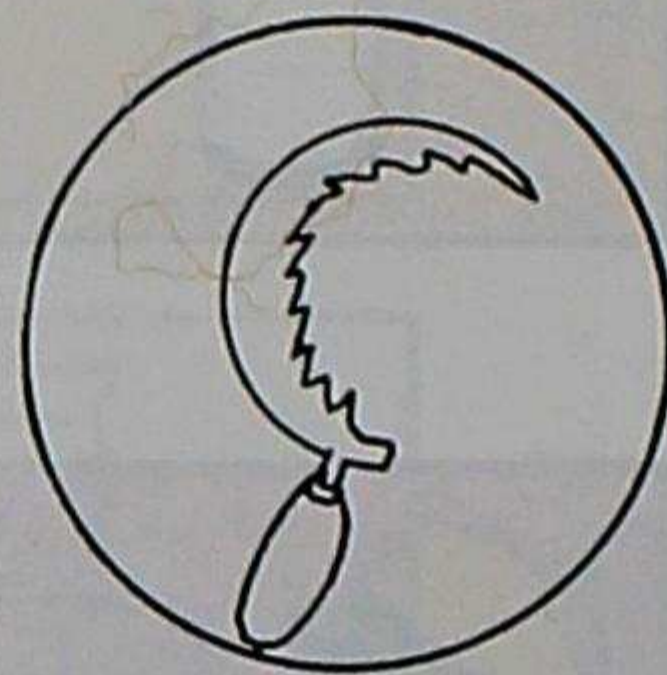

mana llanpu

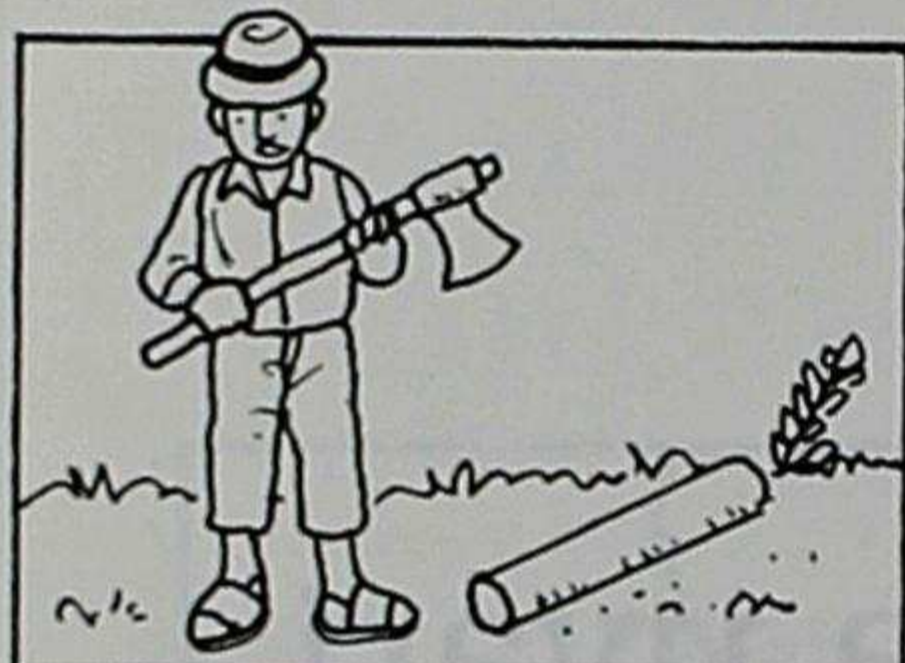

Llanpu caspita chictacun.

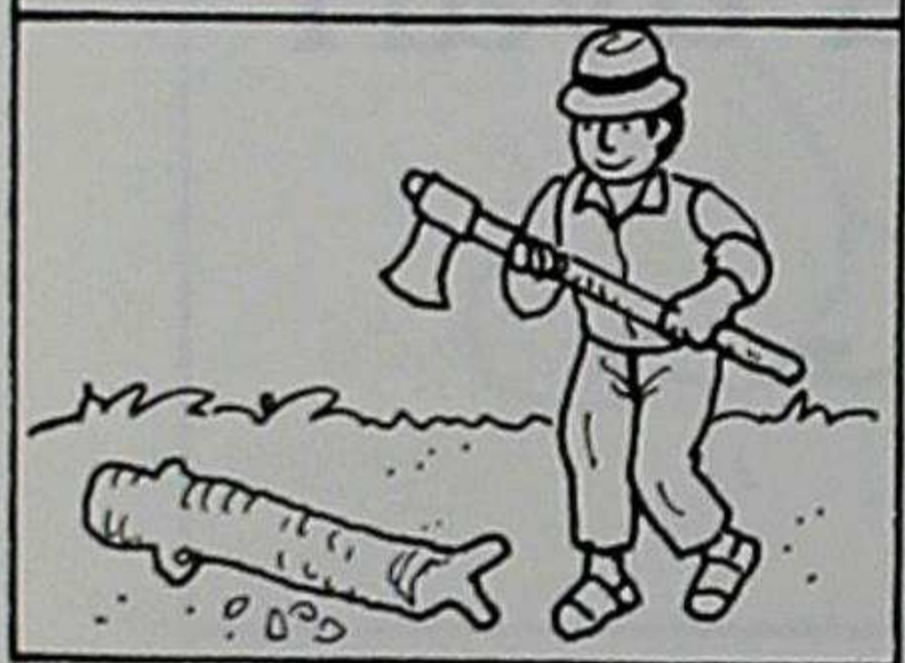

Zacra caspita chictacun.



Mana llanpu ichuhuan quihuata cuchucun.



Llanpu ichuca mana quihuata cuchunchu.

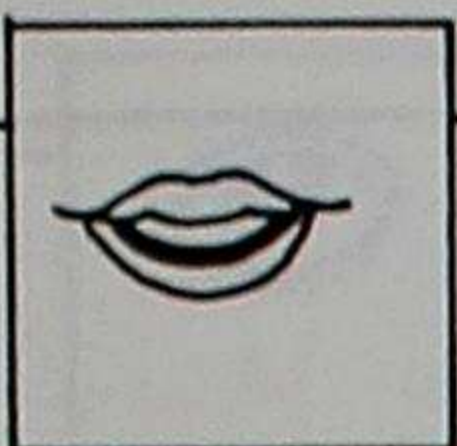

## Ñucanchic aichata ricurianamanta

Ñucanchic quiquin aichaca  
charinchic:

Ñahuihuanca cai pachapi tiyaccunata  
ricunchicmi, chaimantami ricuriashpa  
charina canchic.

Shimihuanca imatapash mallinchic: jayac  
cashcata, mishqui cashcata, cachi  
cashcatapashmi mallinchic. Shinaca,  
punllantami shimitaca maillana canchic.

Tucui aichahuanca imacunatapashmi  
japinchic ñututa, sinchita, chiri cununtin,  
cashpapash japinchic.

Rinrihuanca tucui uyaricunatami uyanchic:  
rimaita, taquinata, shuctac  
uyaricunatapashmi uyanchic.  
Rinri utcumanca ama tuputa  
yaicuchinquichu, rinrica chauchallami  
can.

Sincahuanca imatapashmi mutquinchic:  
tucui sami ashnaccunatami mutquinchic.  
Sincataca pichashpami charina canchic.

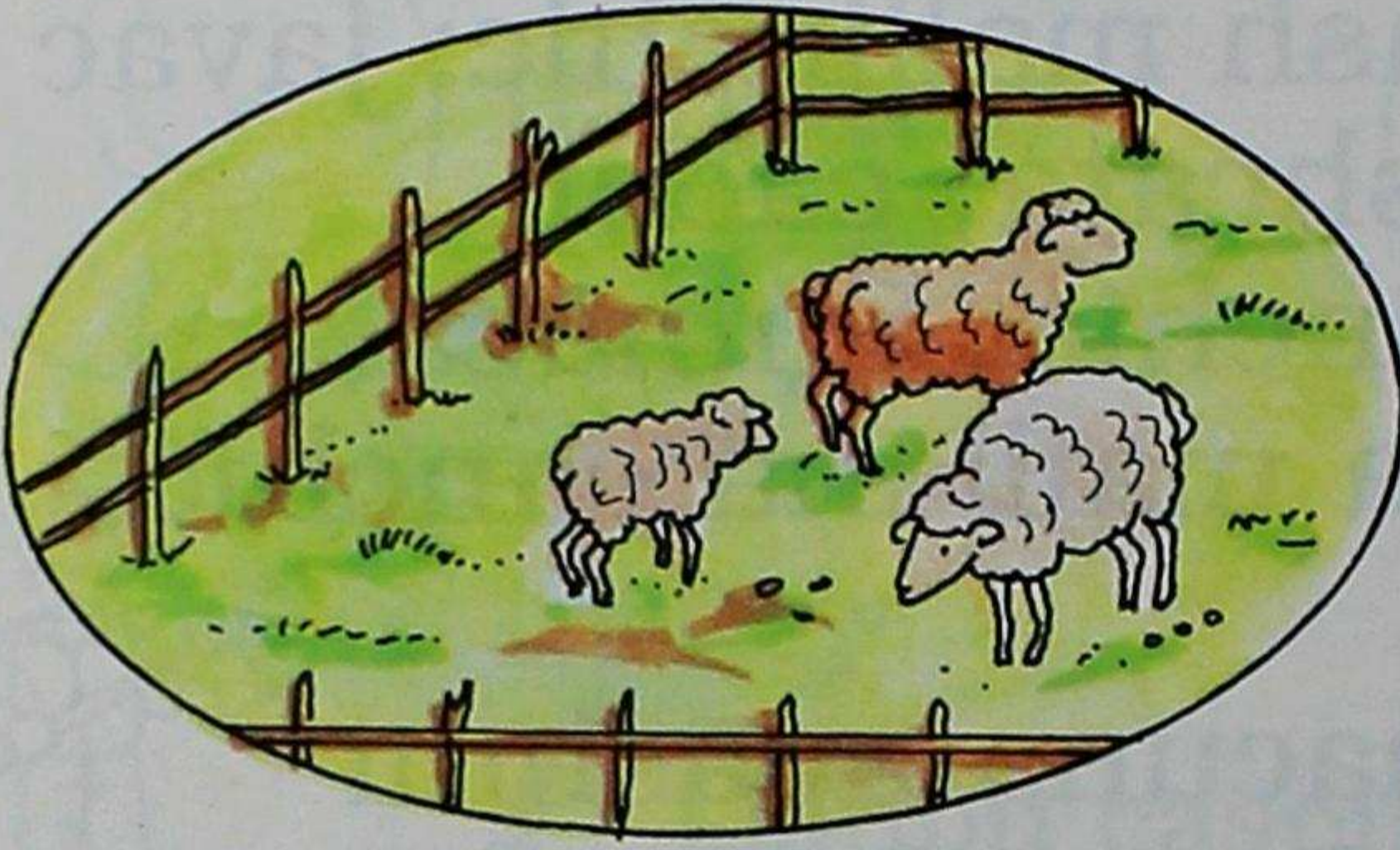
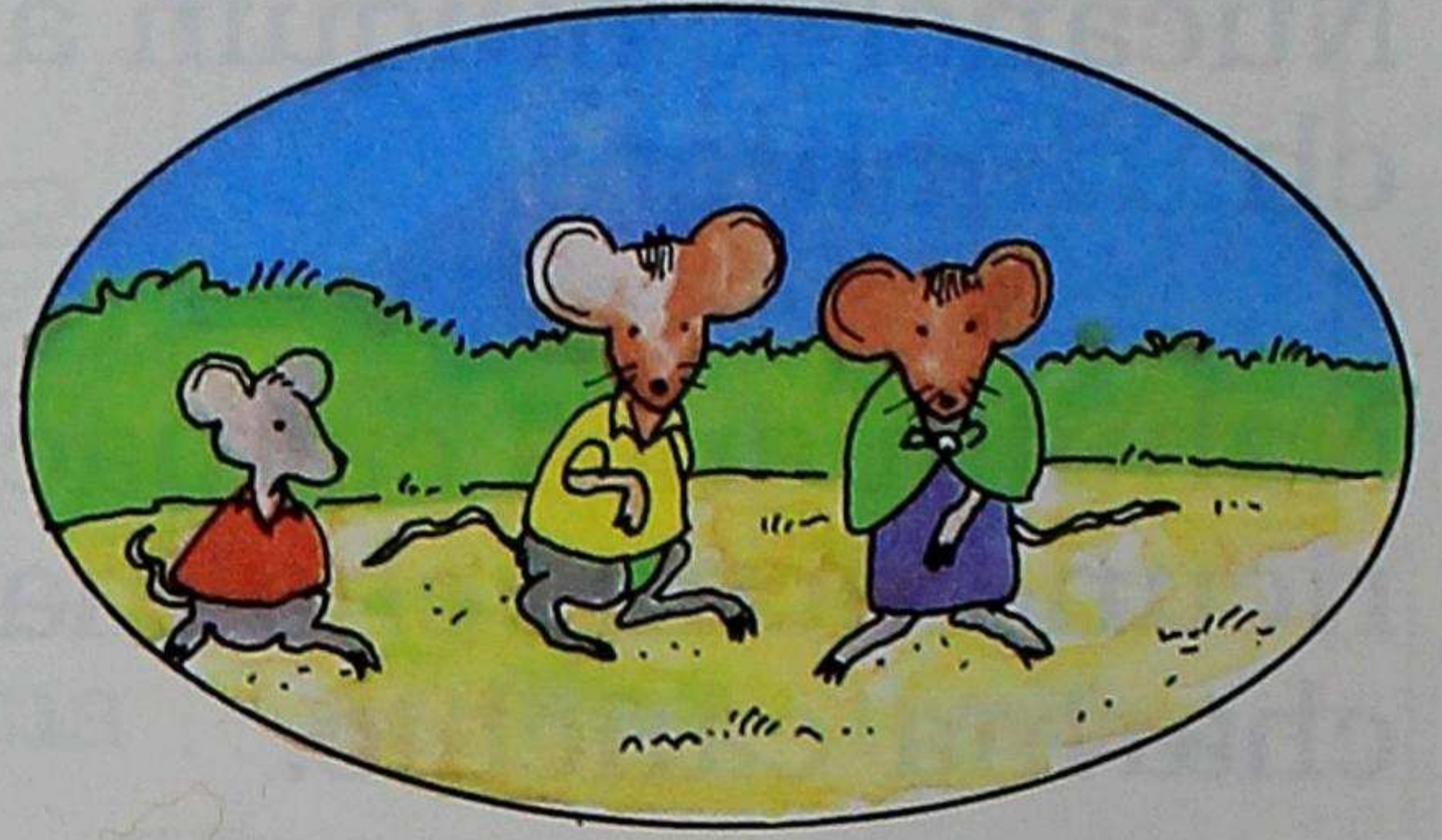
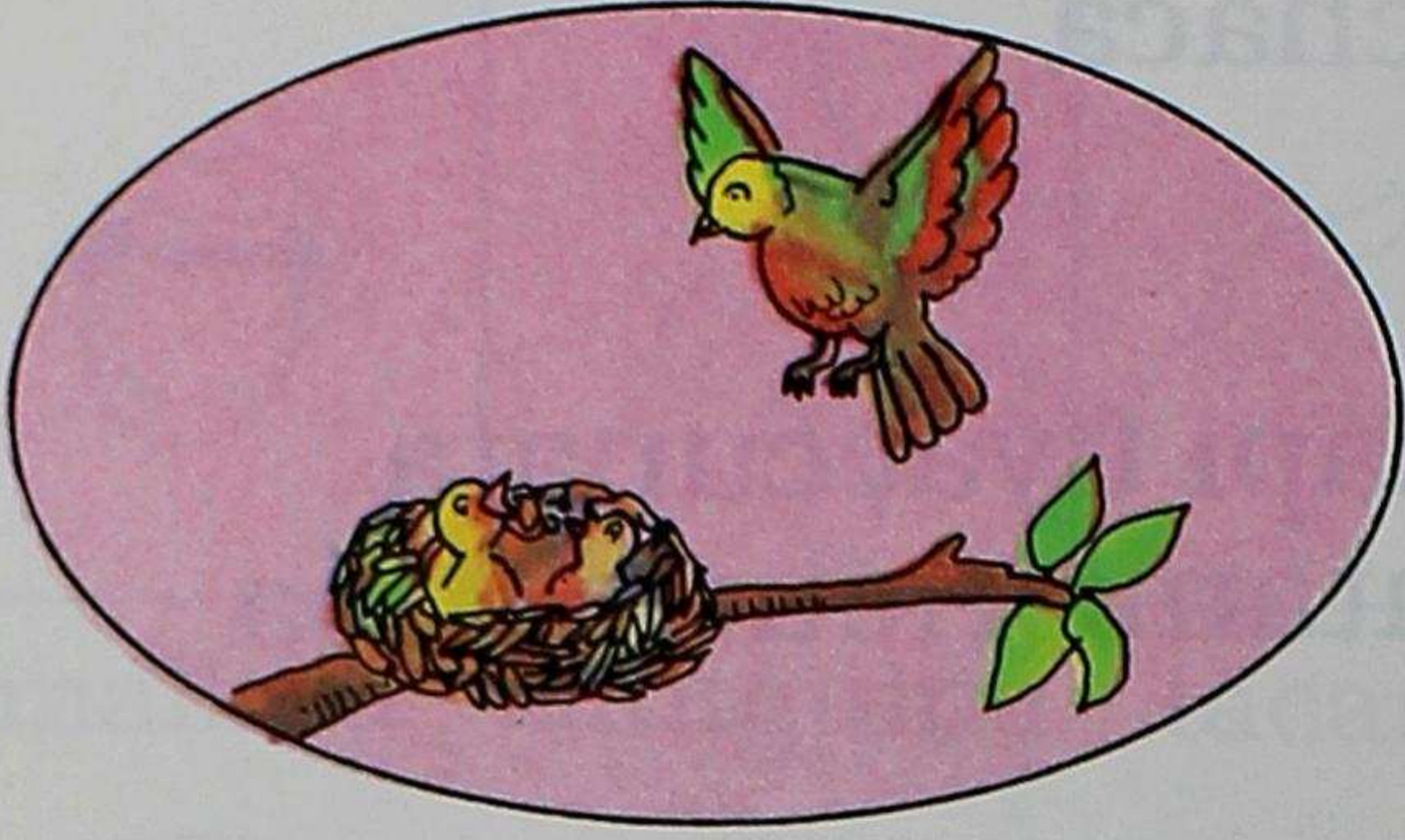
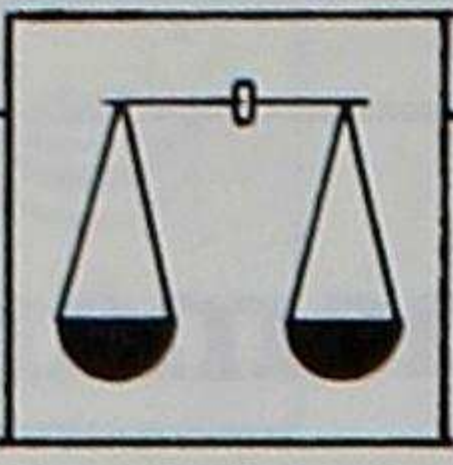

## **Aillu huasimanta**

Tucuicunami aillupi tantarishpa  
causana canchic.

Cashna causancapacca huasita  
charinami canchic.

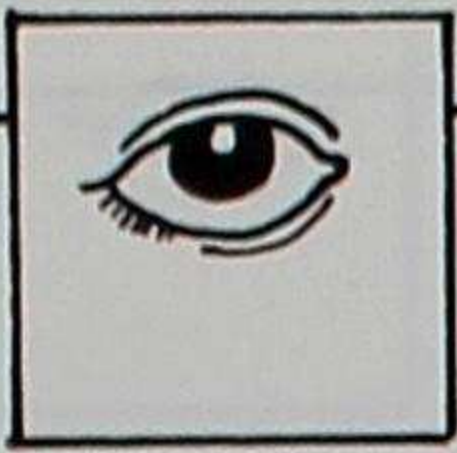

# Allpamanta ruraicuna

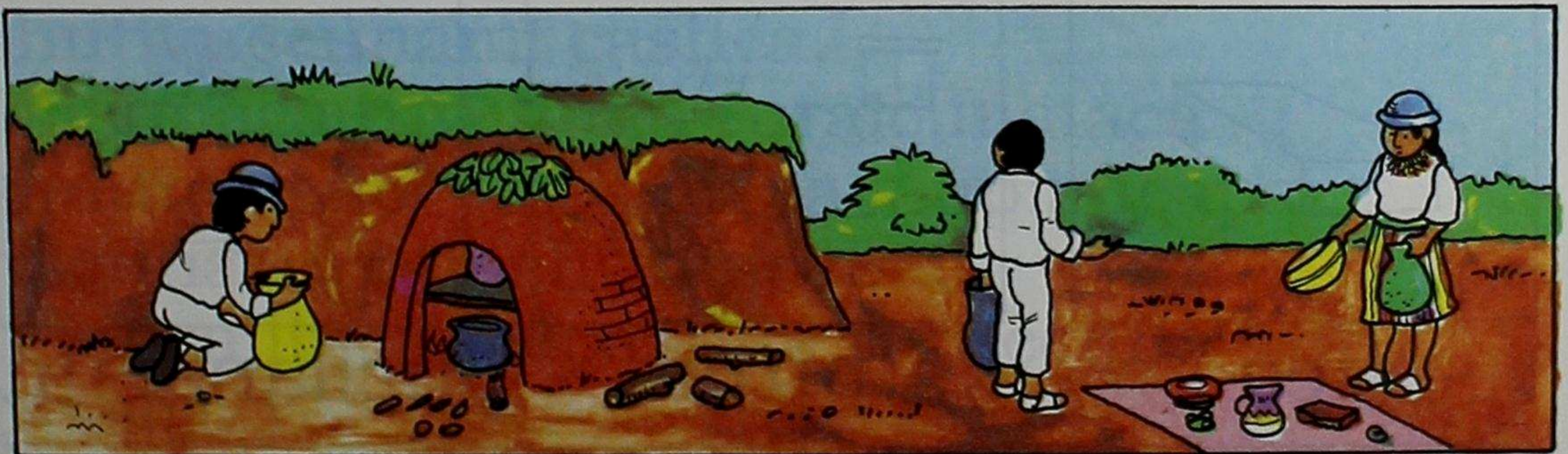
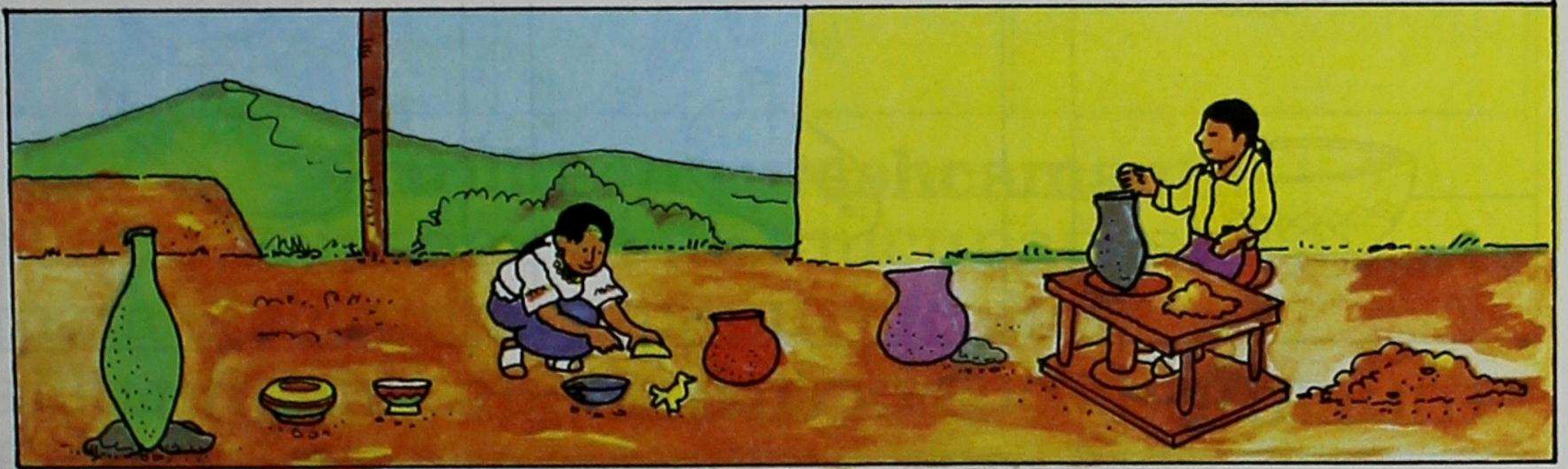
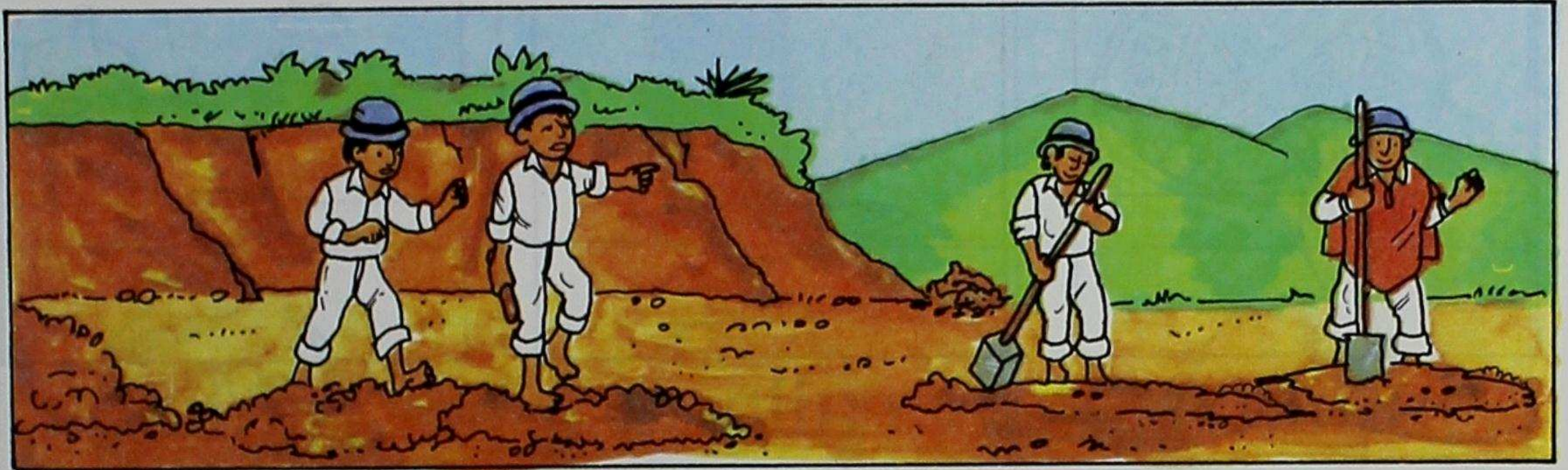
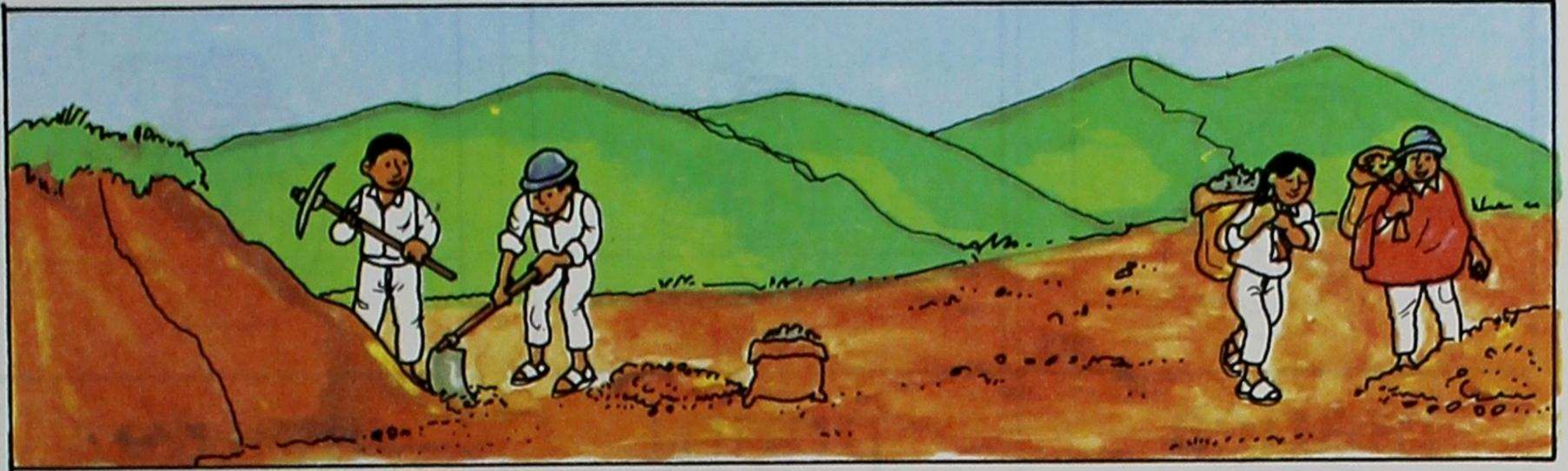

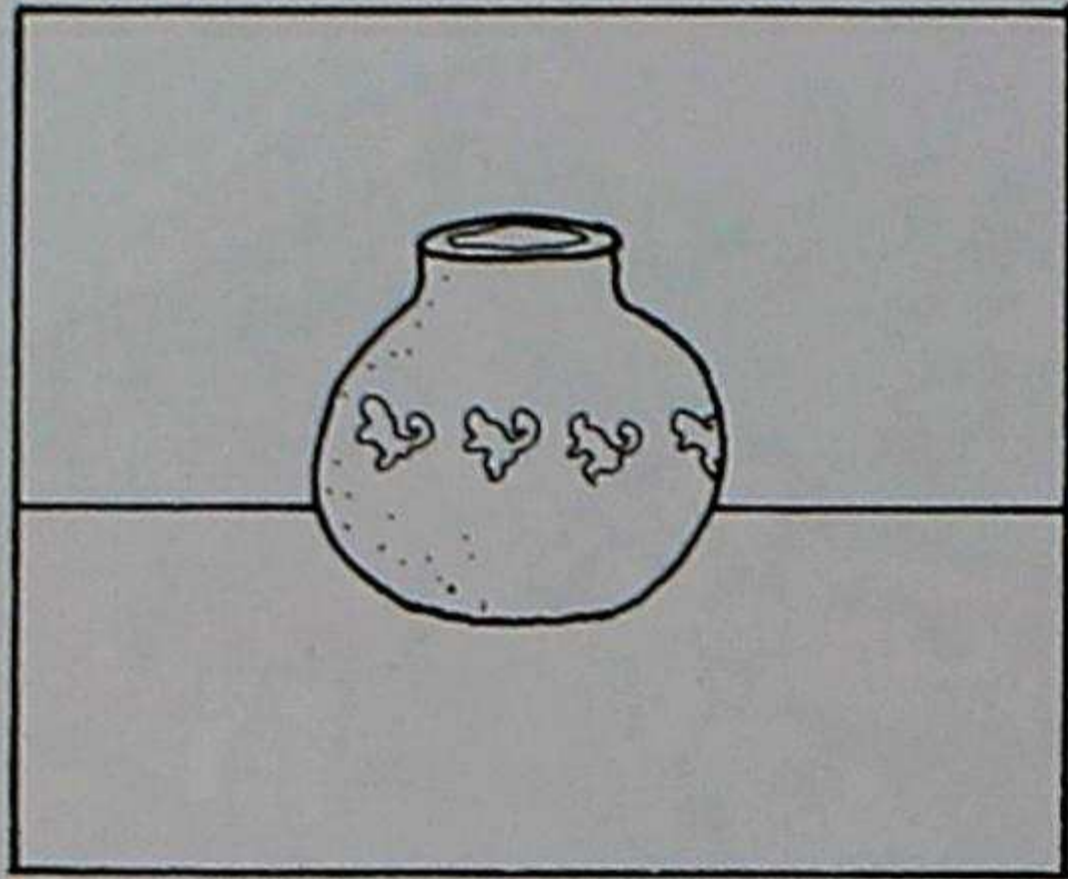
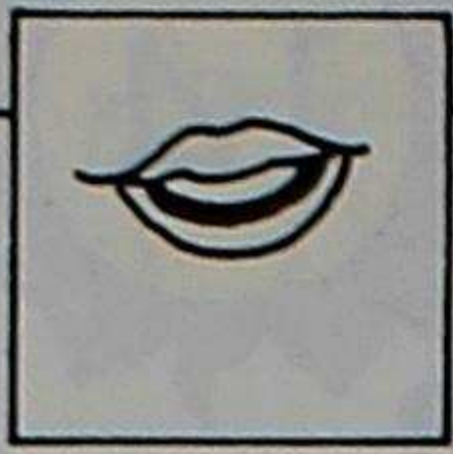

manca

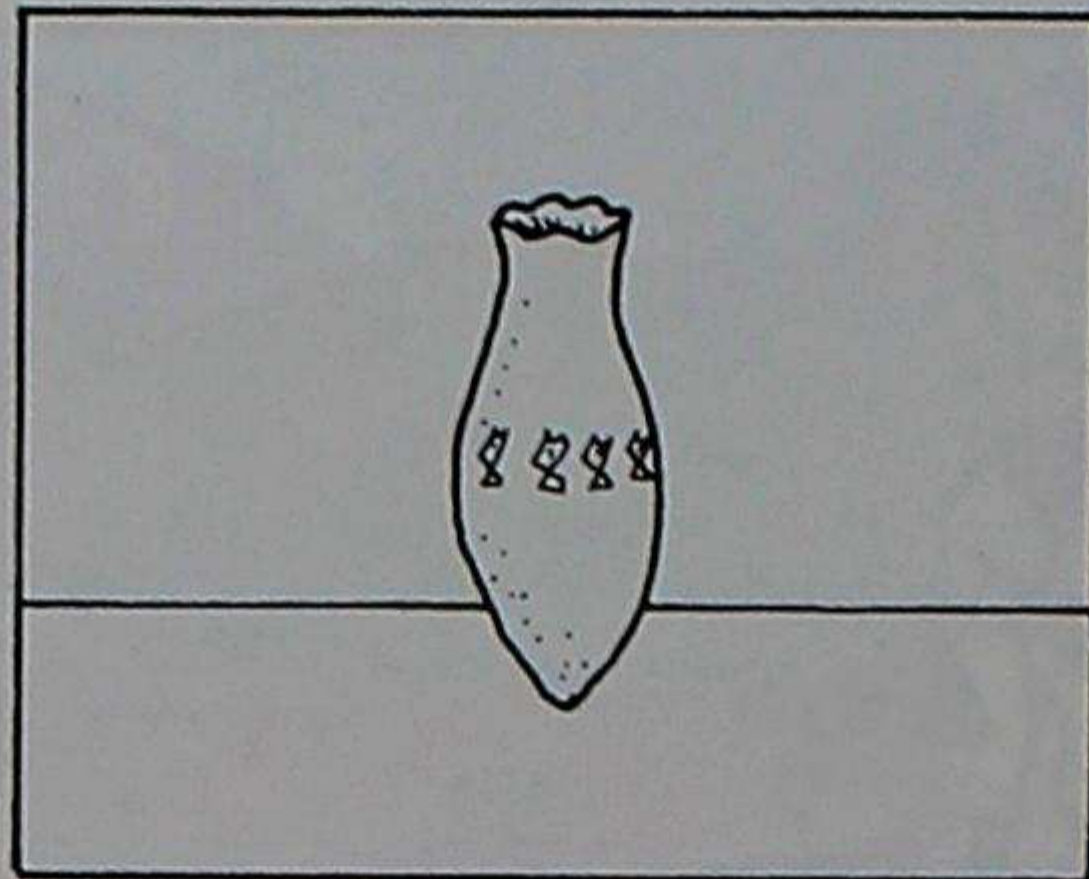

puntu

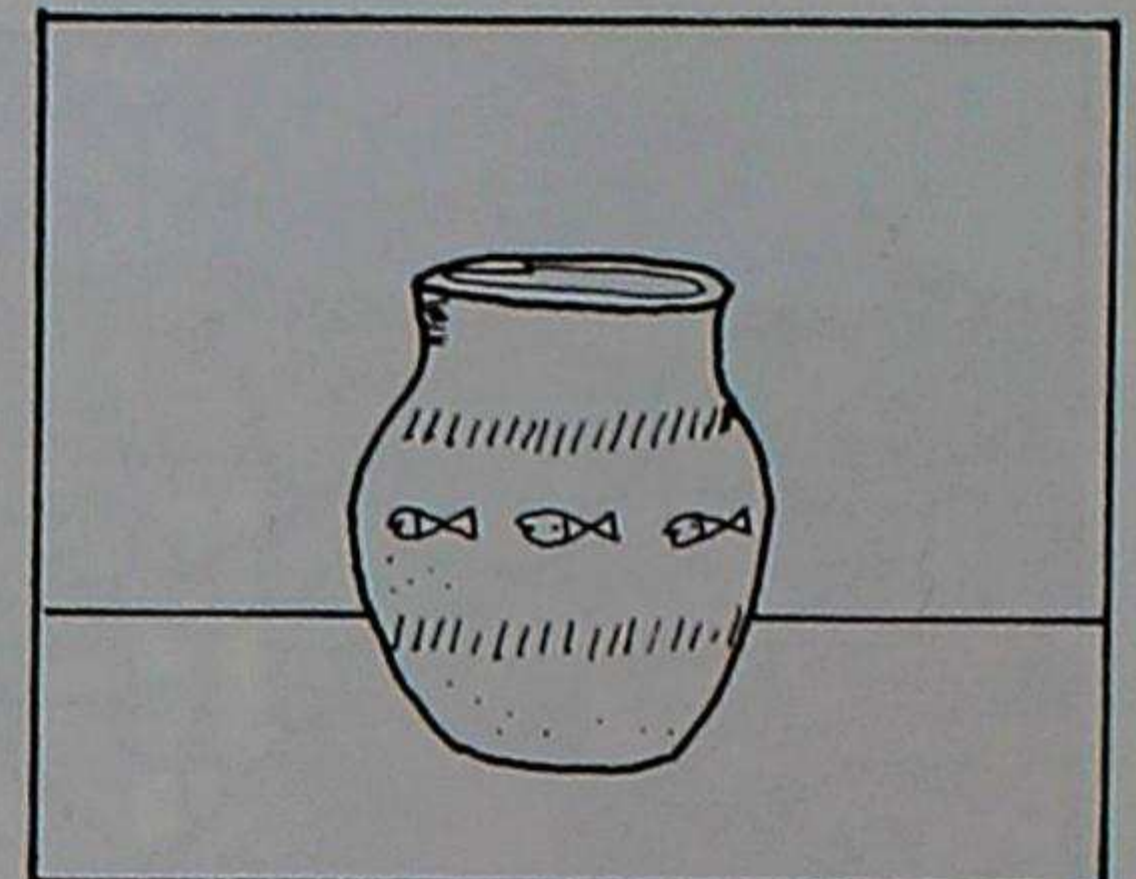

mauma

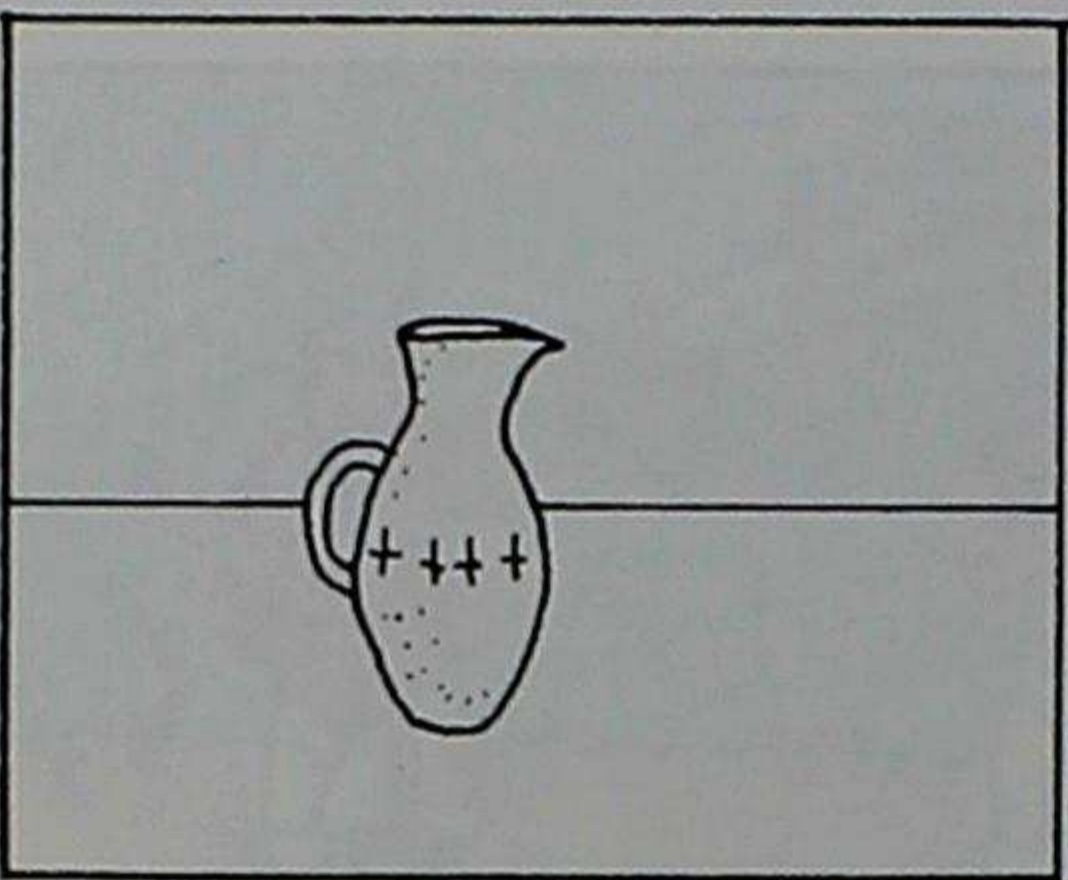

shila

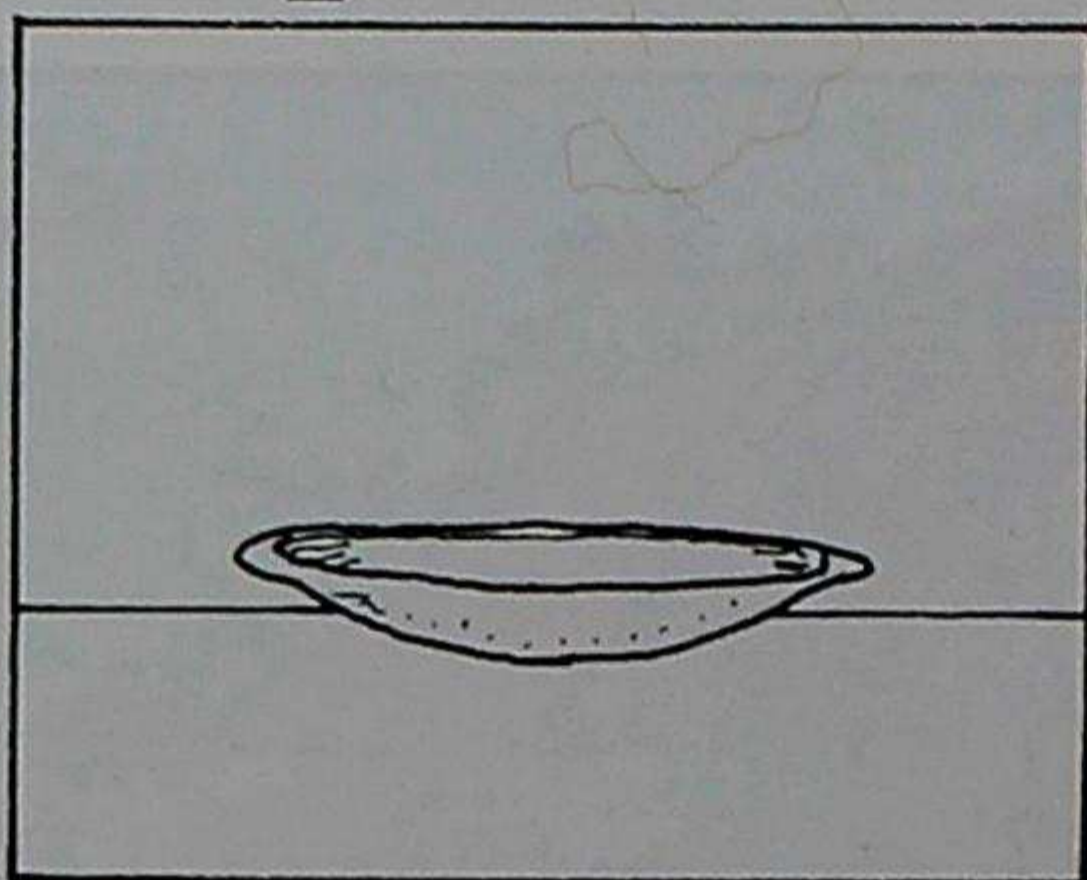

callana

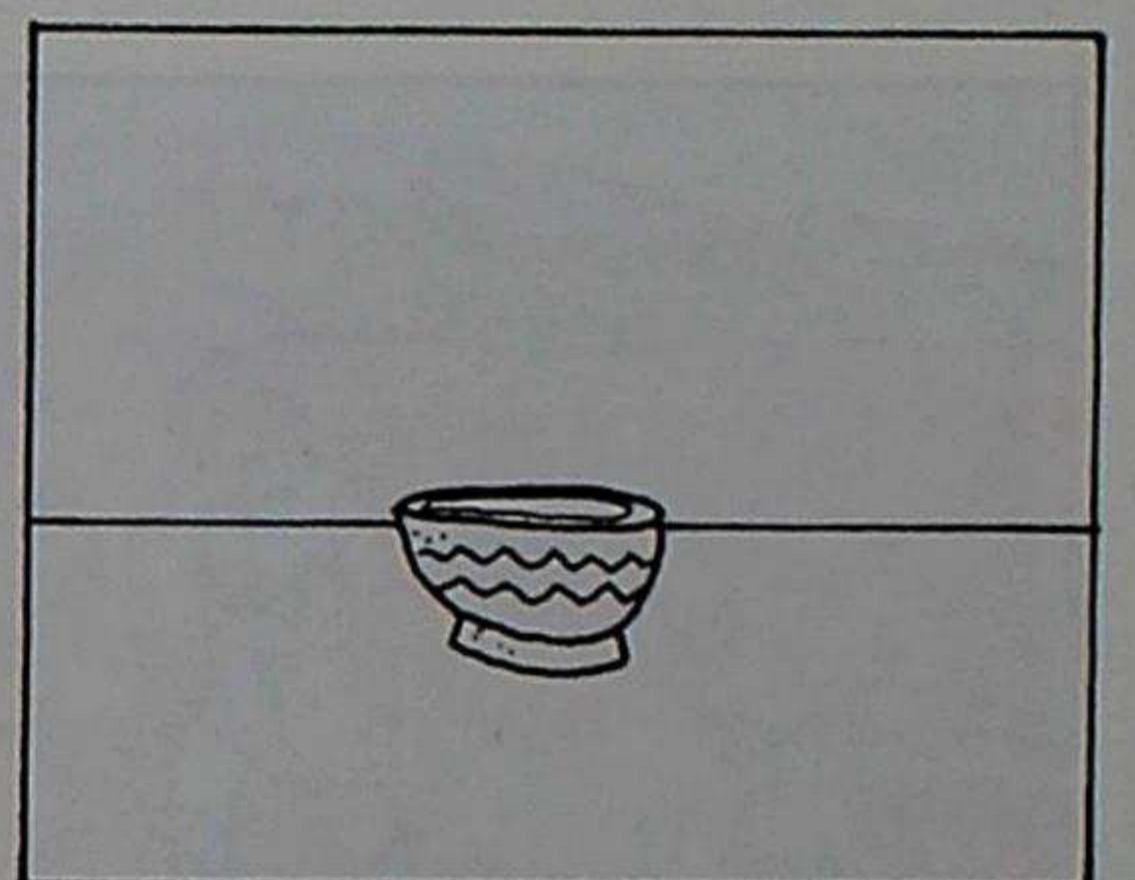

mulu

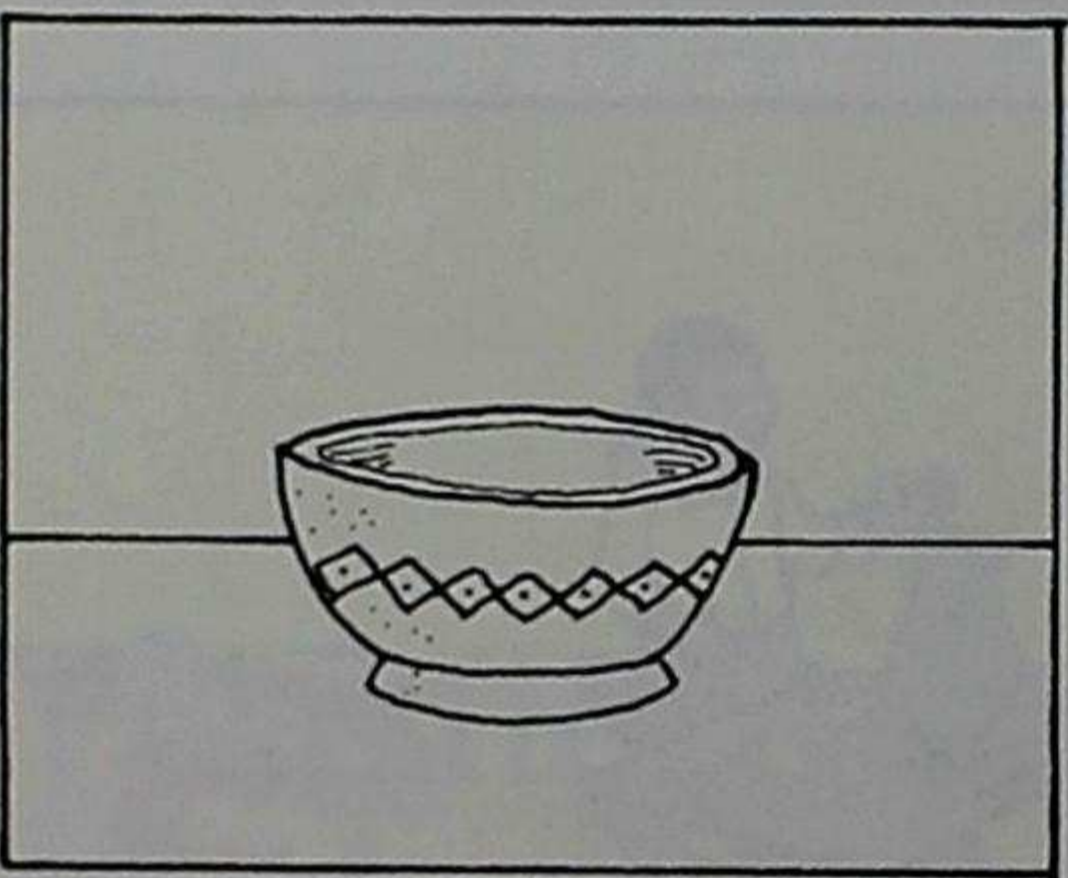

mucahua

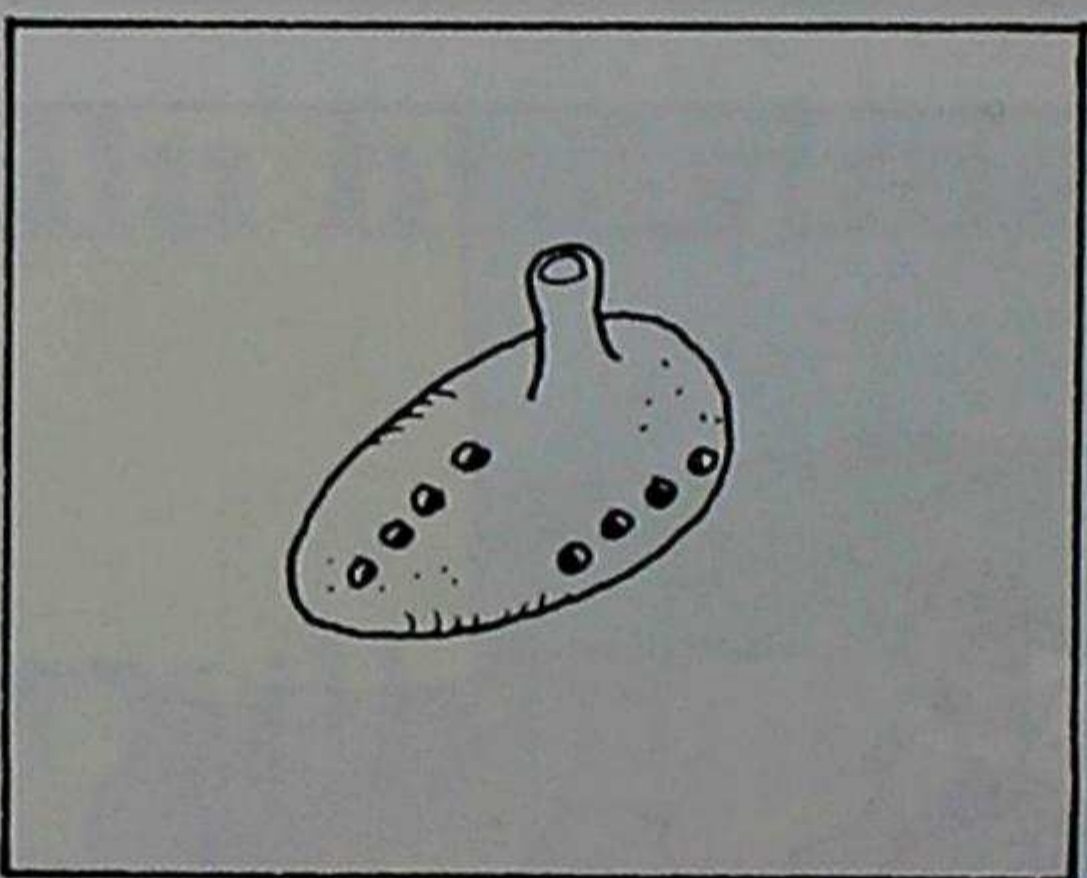

ocarina

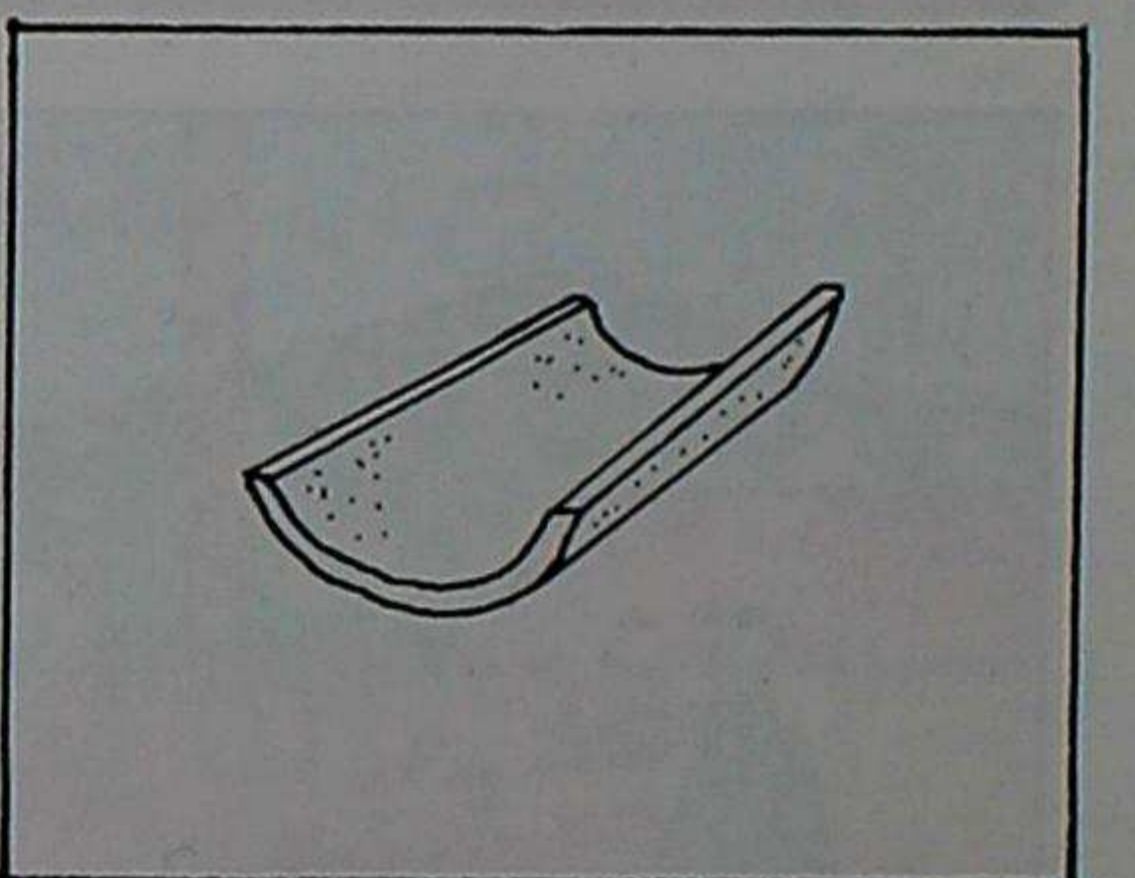

sañu

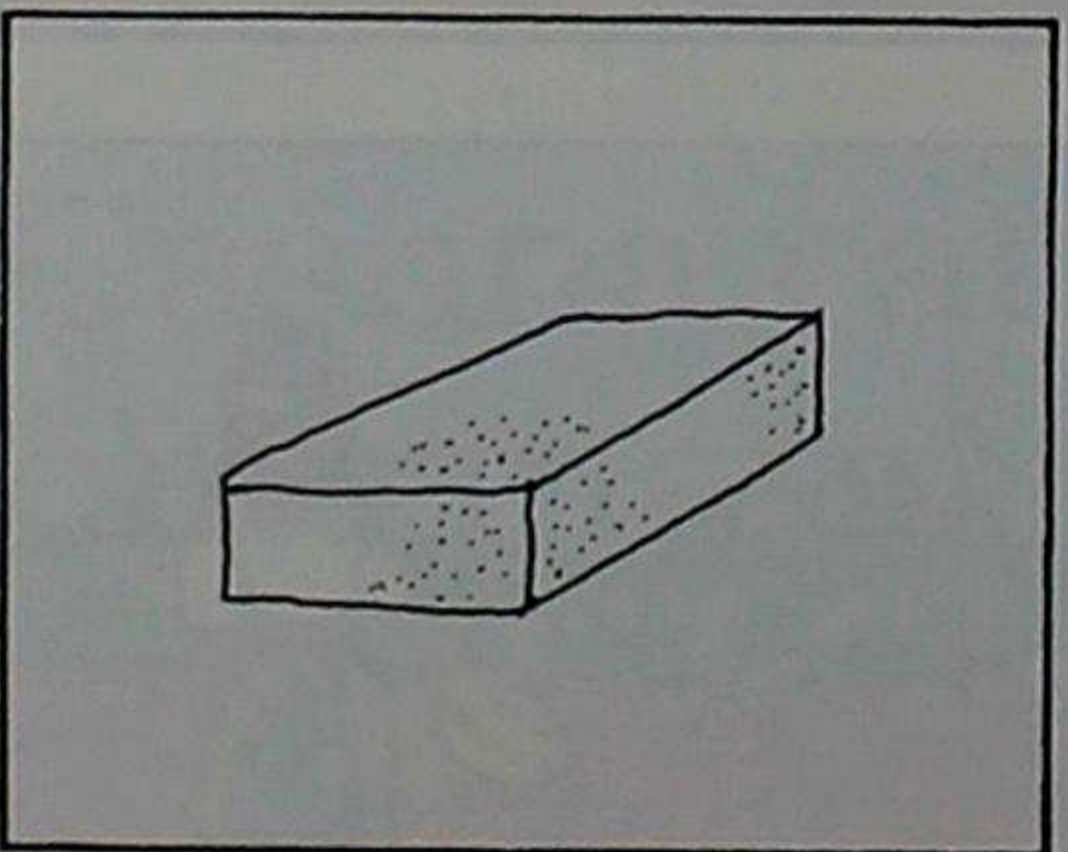

tica

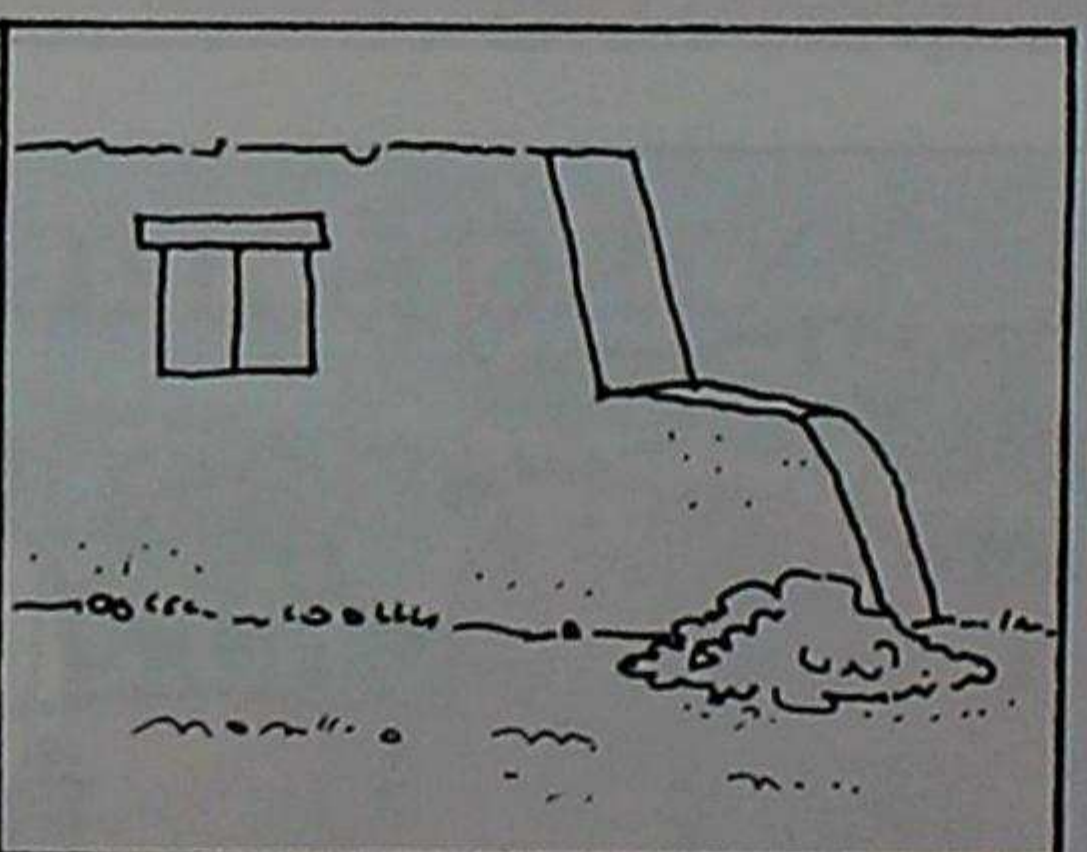

pirca

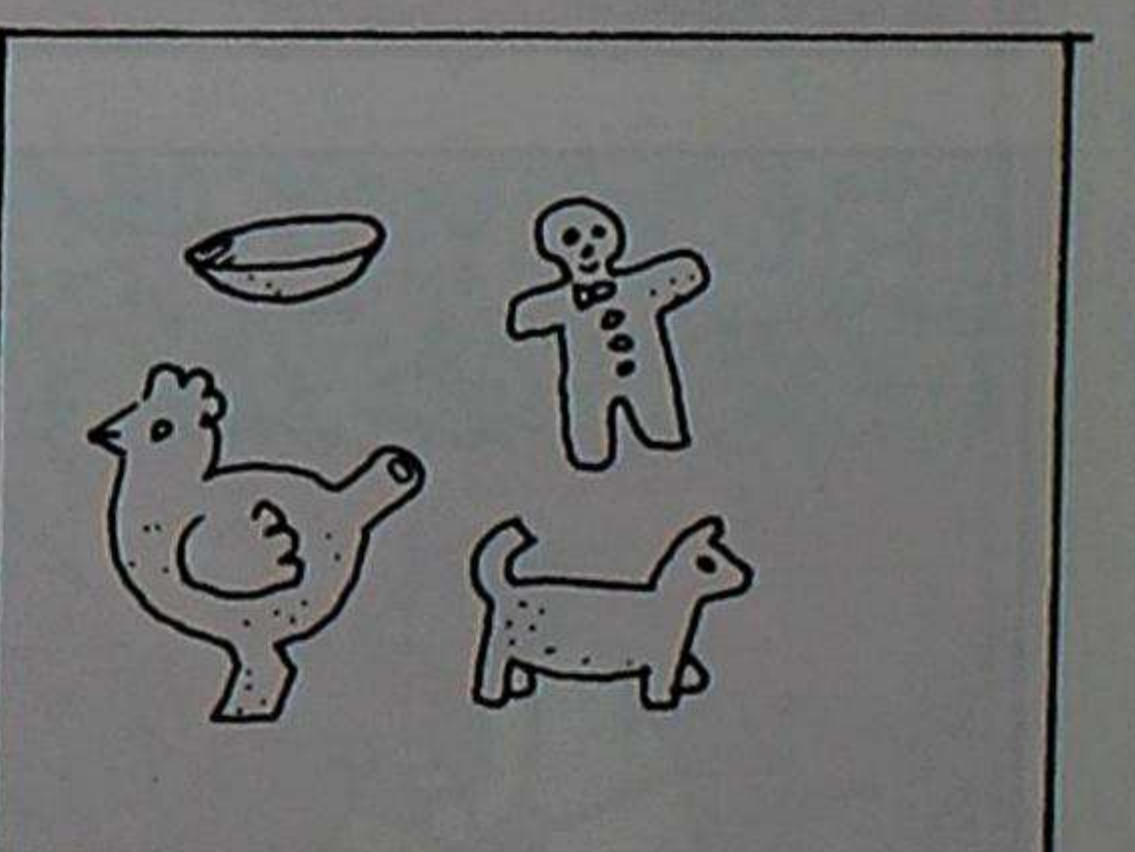

pucllanacuna

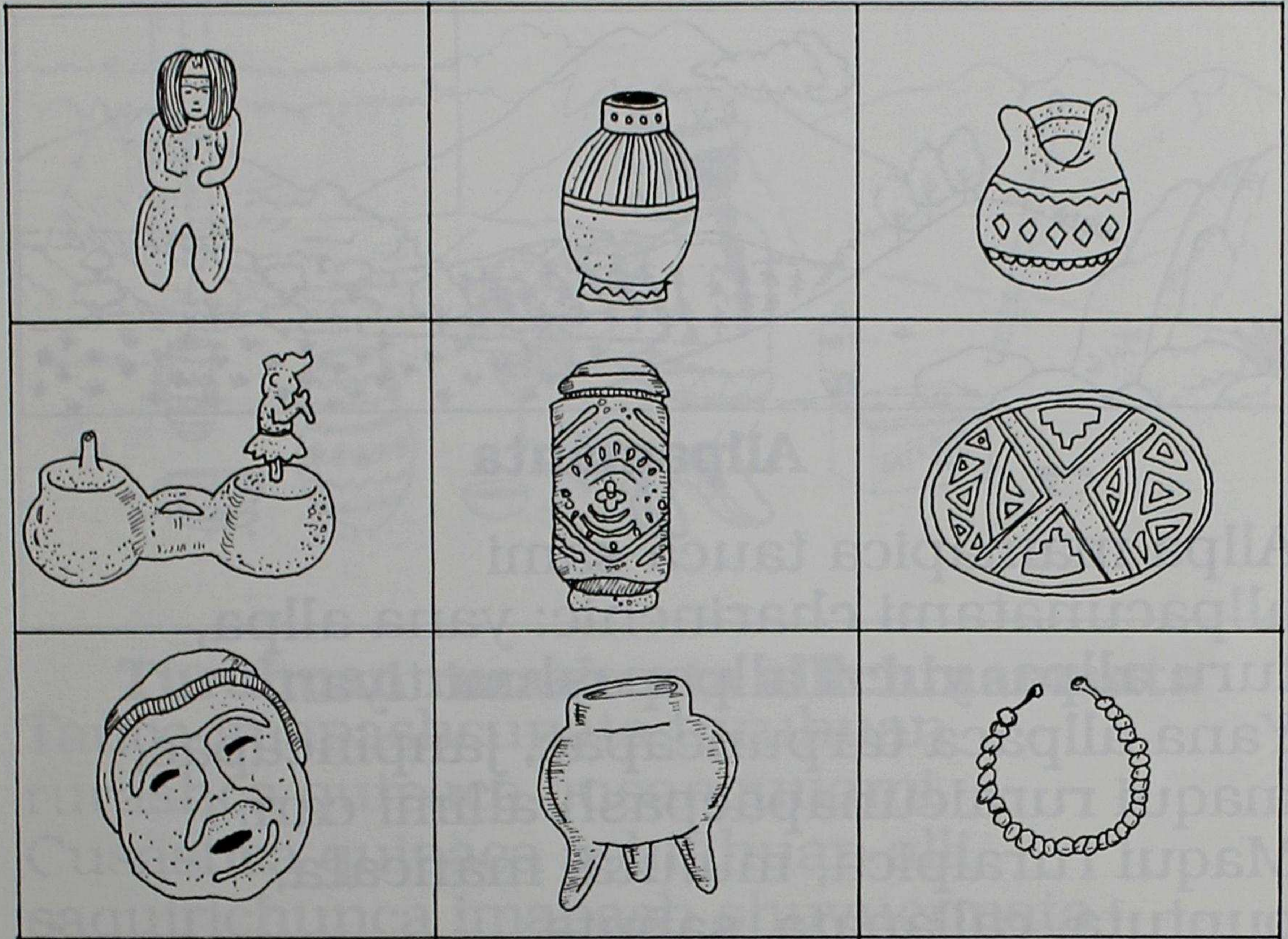
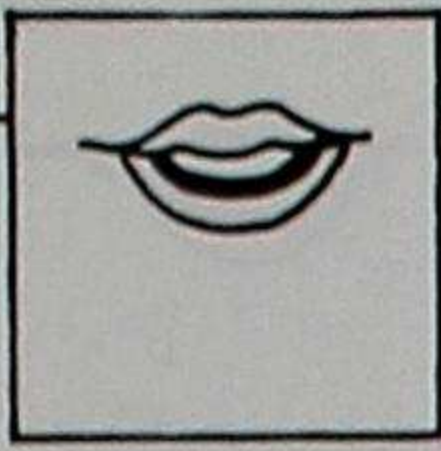

### **Turuhuan rurashcamanta**

Manarac incacuna mishucunapash cai  
mamallactaman shamucpica tauca  
aillucunami causaccuna cashca.

Cai aillucunaca shuctac shuctac  
shutiyuccunami cashca.

Paicunaca turuhuan ruraicunataca  
yanuncapac, taquincapac, upiancapac,  
micunacunata churancapac  
hualllincapacpashmi ruraccuna  
cashca.

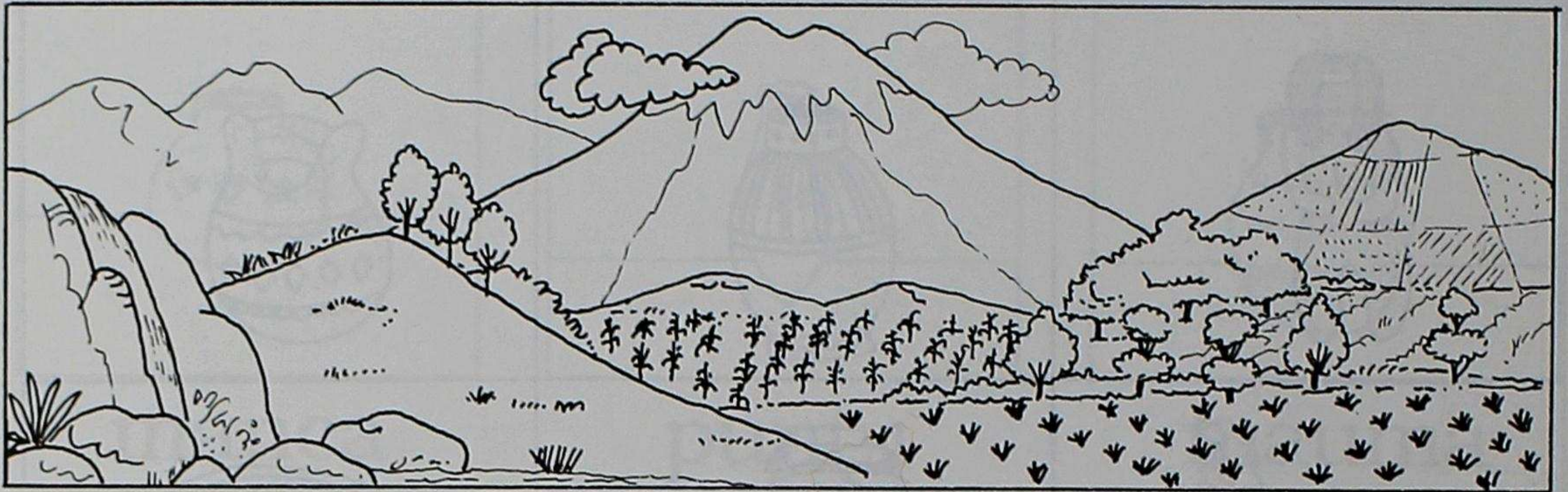
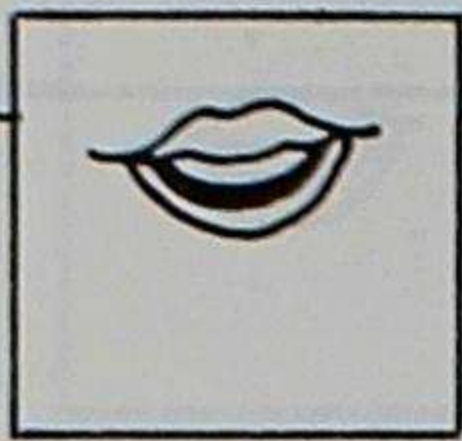

## Allpamanta

Allpa mamapica tauca sami  
allpacunatami charinchic: yana allpa,  
turu allpa yuczi allpapashmi tiyan.  
Yana alpaca tarpuncapac, janpincapac,  
maqui ruraicunapacpash allimi can.  
Maqui ruraipica, muluta, mancata,  
puntutata, callanata, sañuta  
shuccunatapashmi ruraita ushanchic.

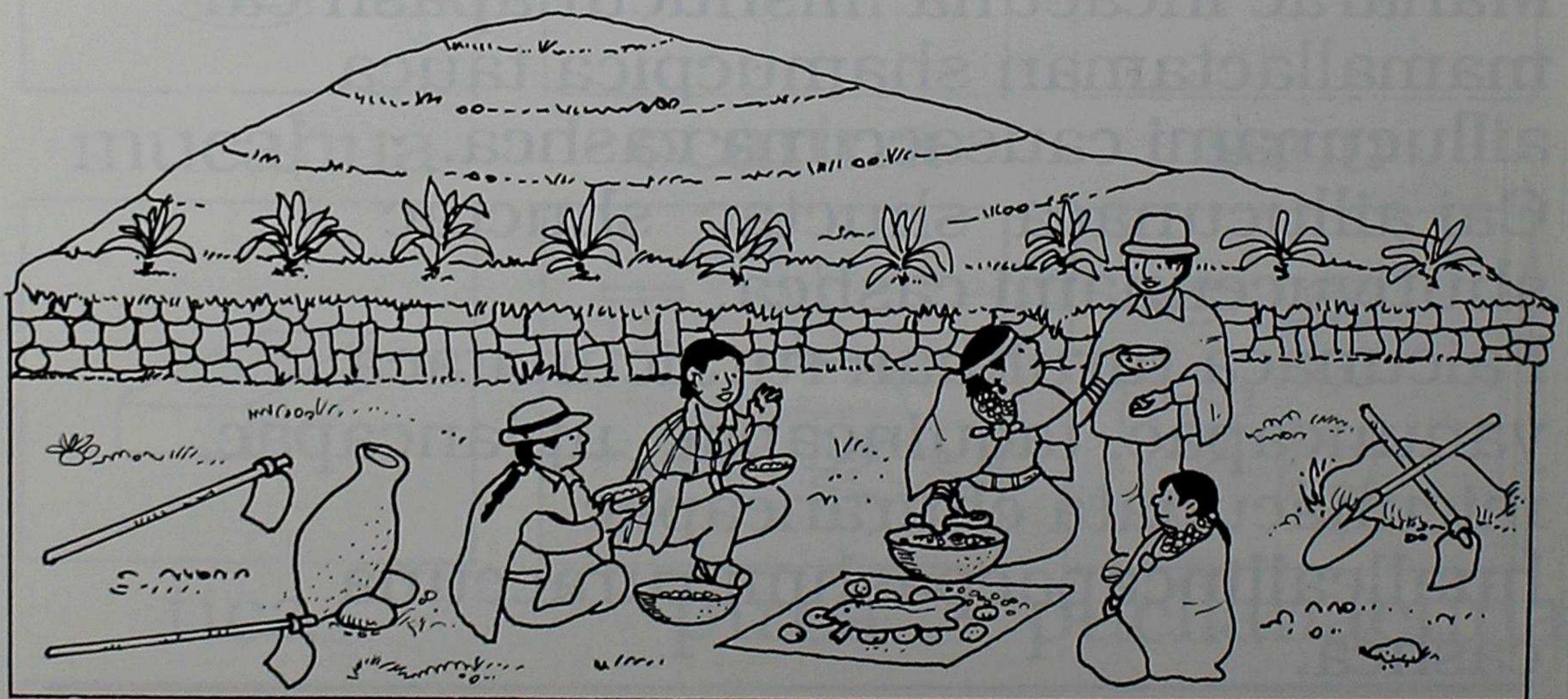

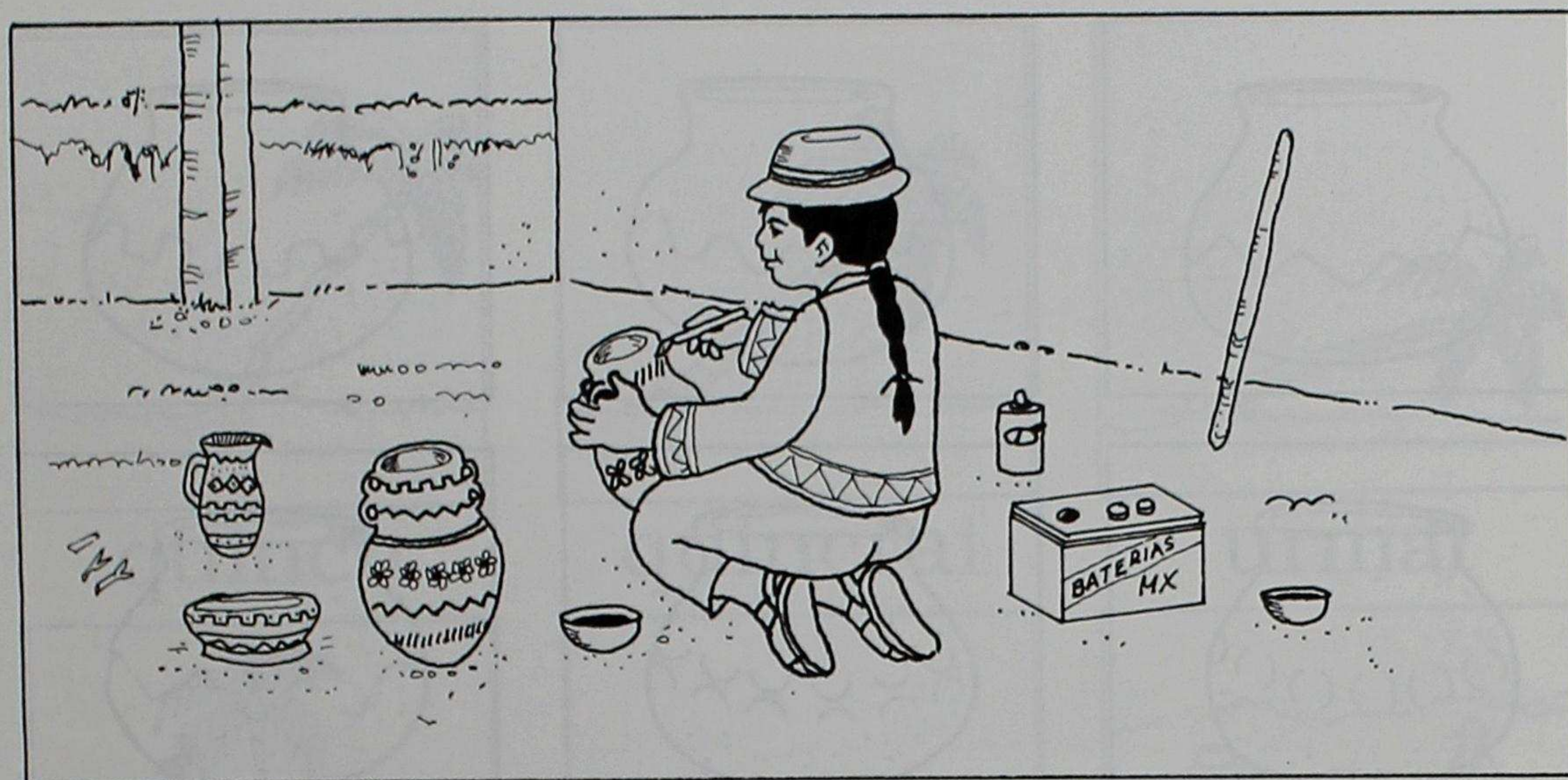
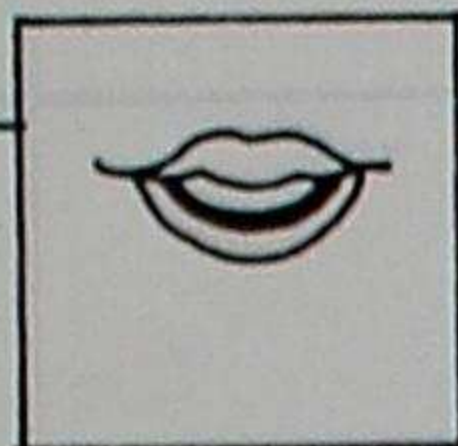

## **Turuhuan rurashcata allichinamanta**

Tauca imapashcunata turuhuan  
rurashca quipaca cusancunami.  
Cusashca quipaca ashtahuan alli  
saquirichunca imapash shuyucunata  
tullpuncuna.

Cai ruraicunata ñaupa pachapica: puca  
allpahuan, yurac allpahuan, quillu  
allpahuan tullpuccuna cashca.  
Shuc allpahuanllatami llipiachic  
cascha.

Cunanpica bateriamanta, pilamanta,  
titita llucshishpami llunchincuna.  
Titihuan llunchishca mucahuapica  
mana micunachu can.  
Ñucanchic aichataca uncuchinllami.



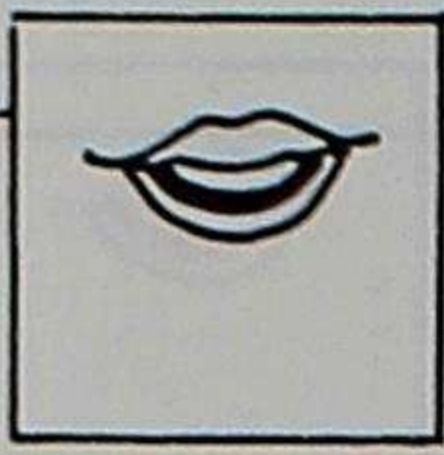

# quincu

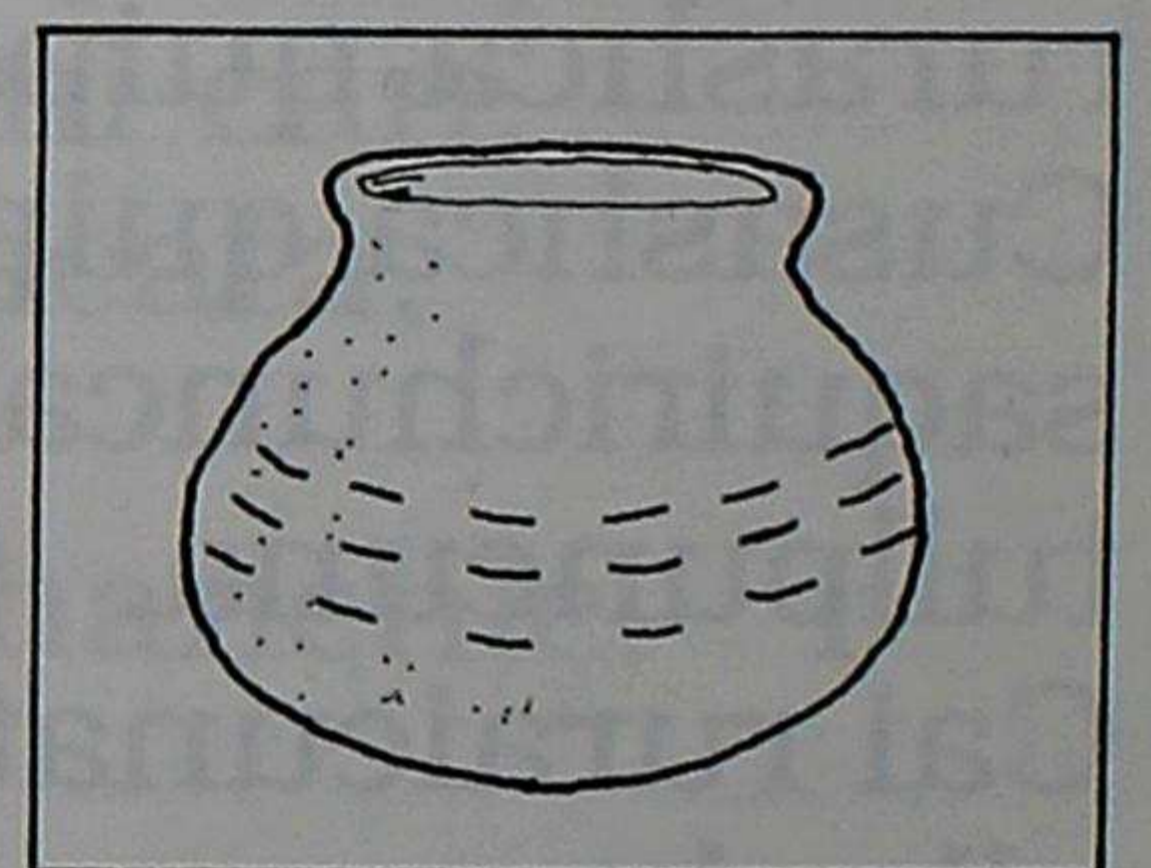
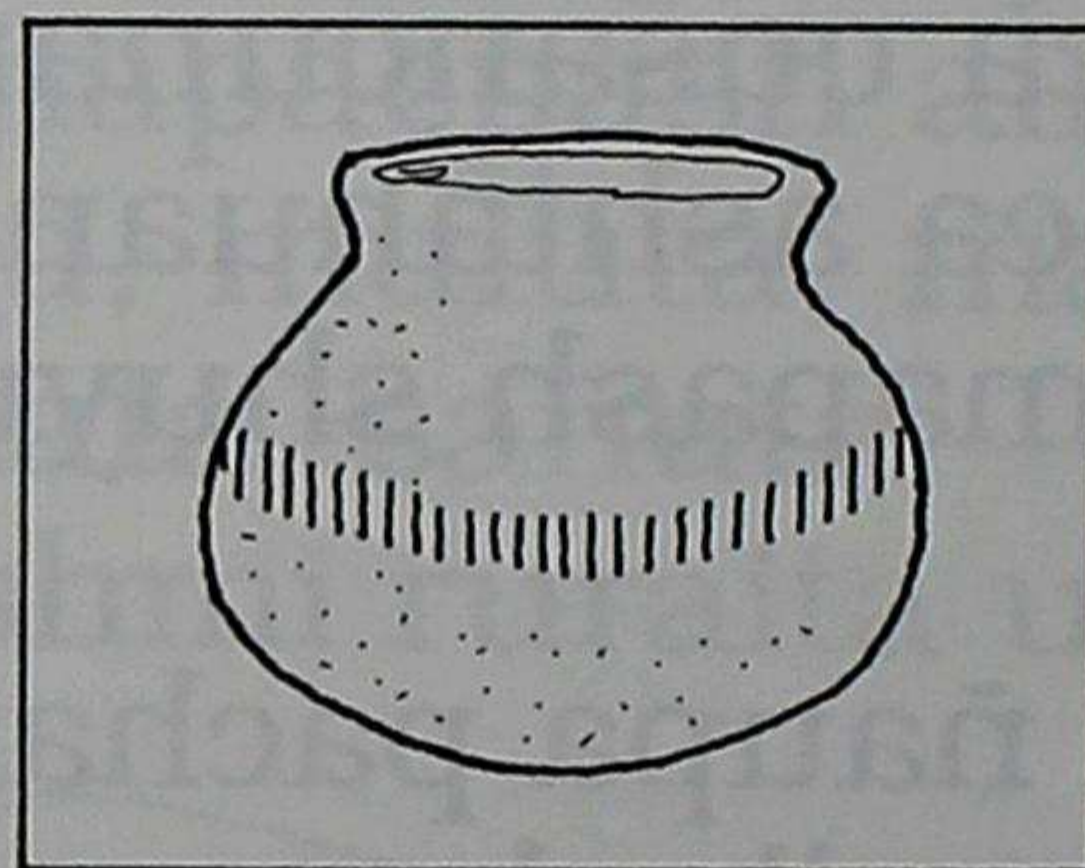
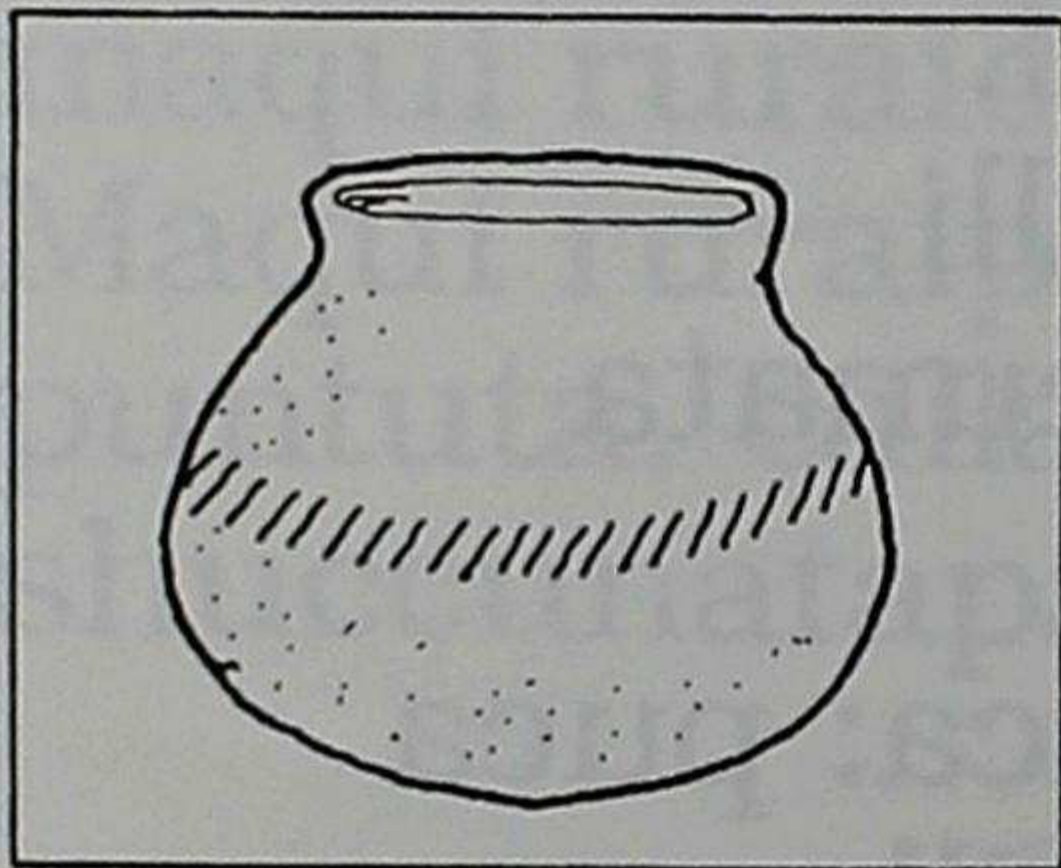
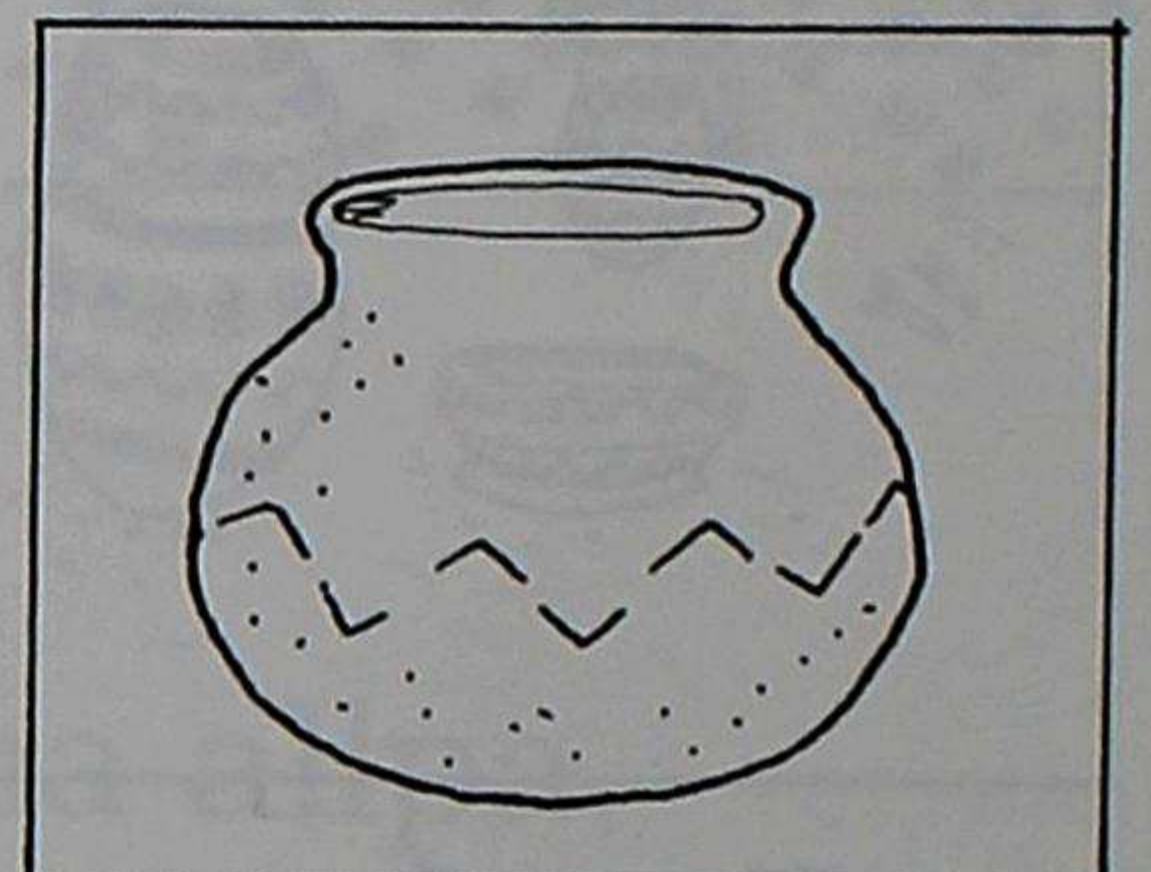
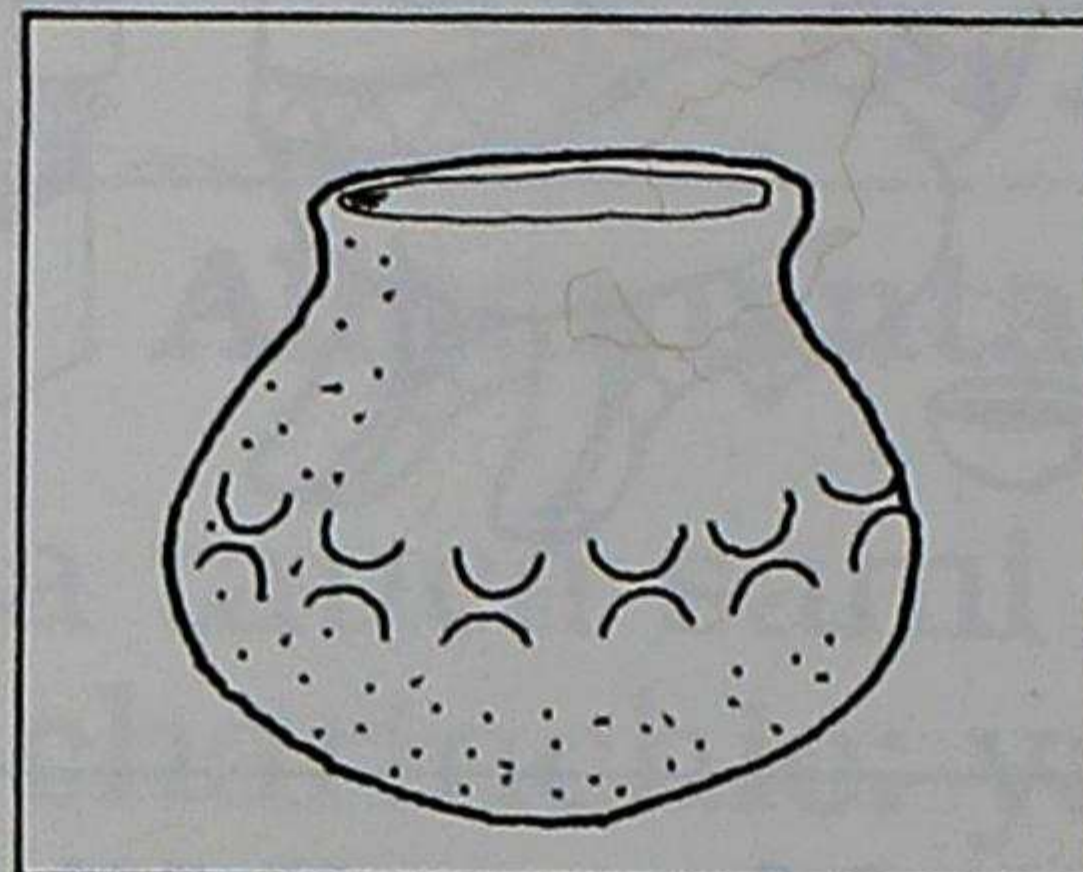
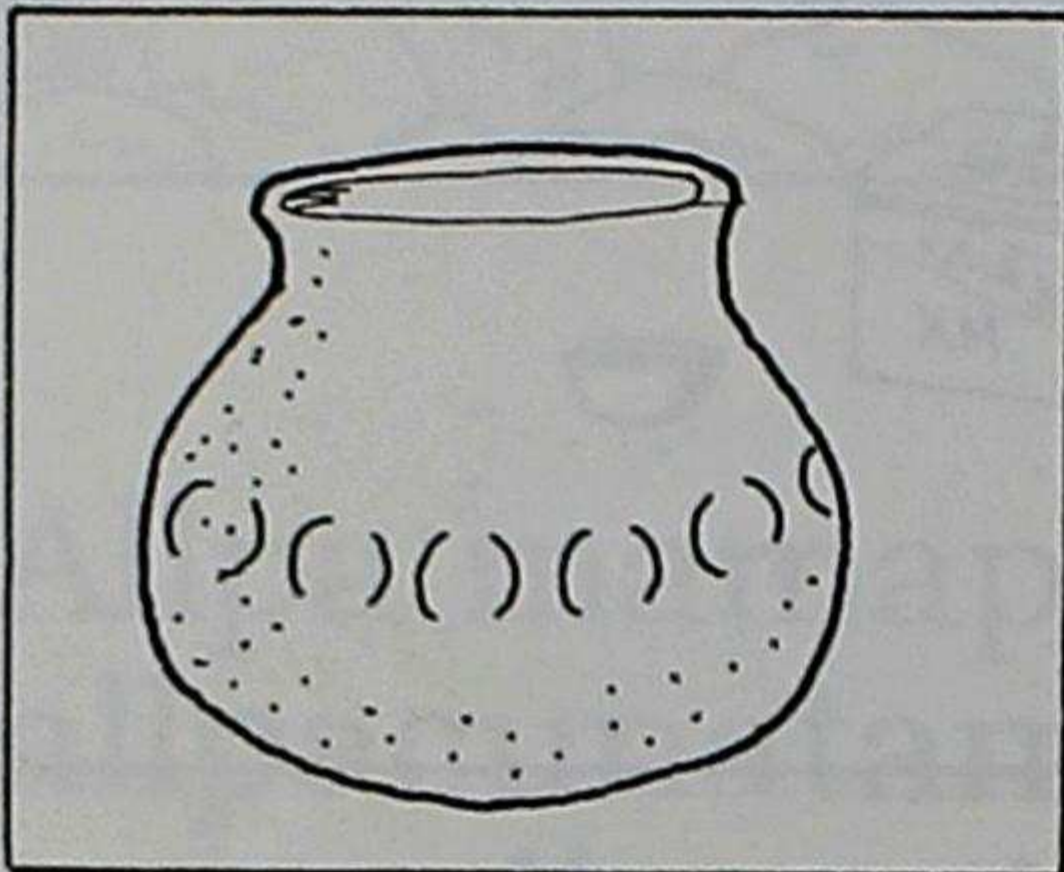
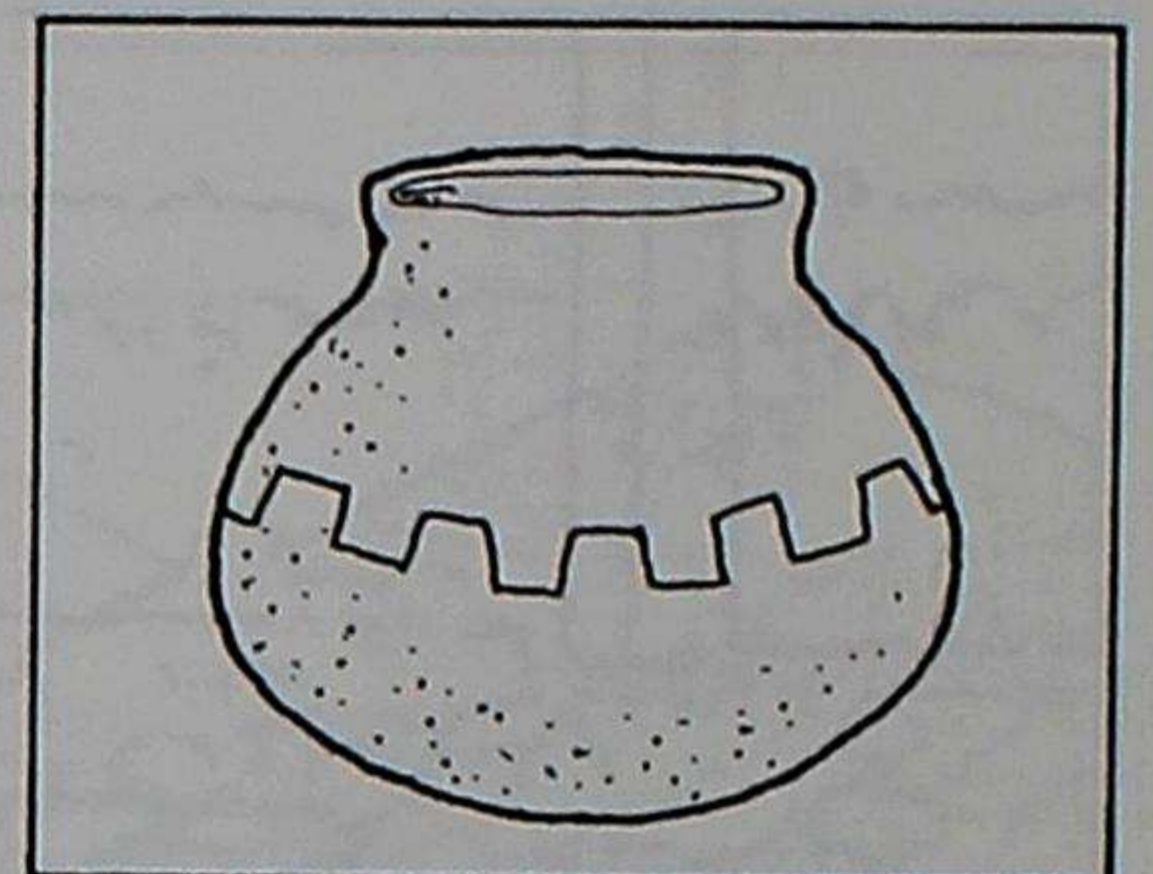
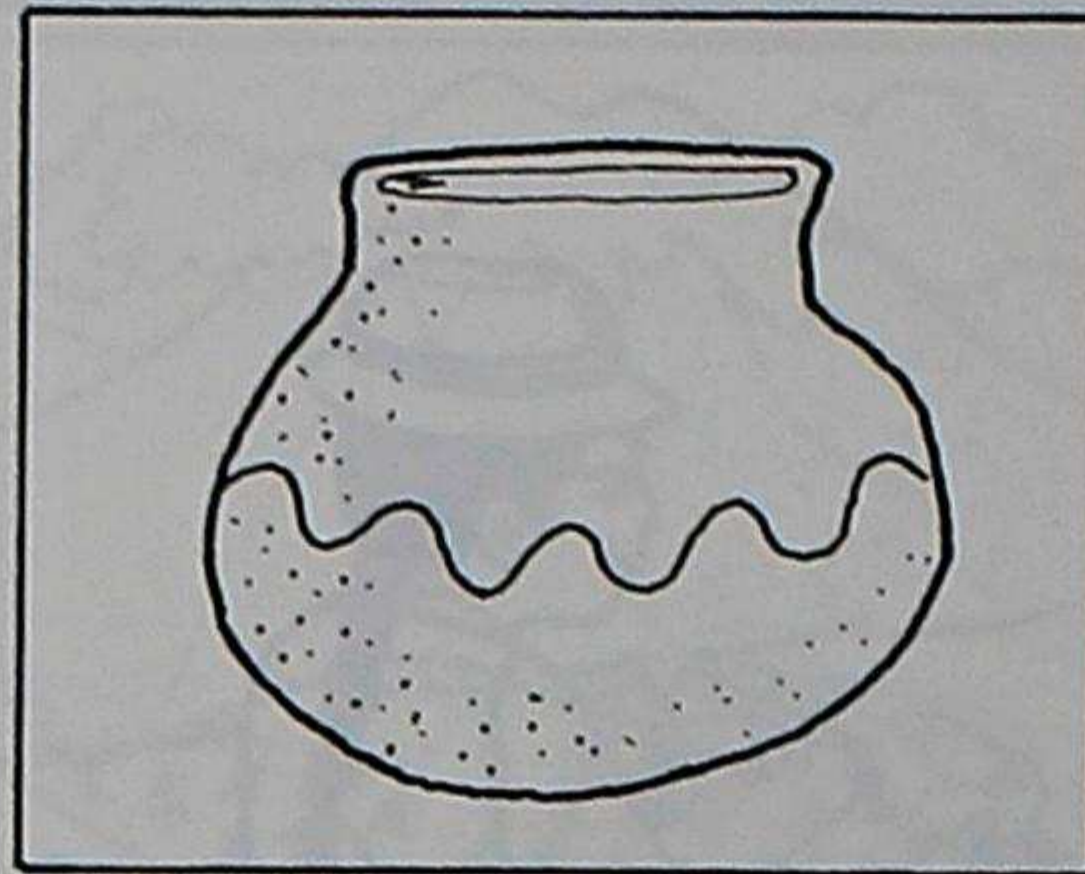
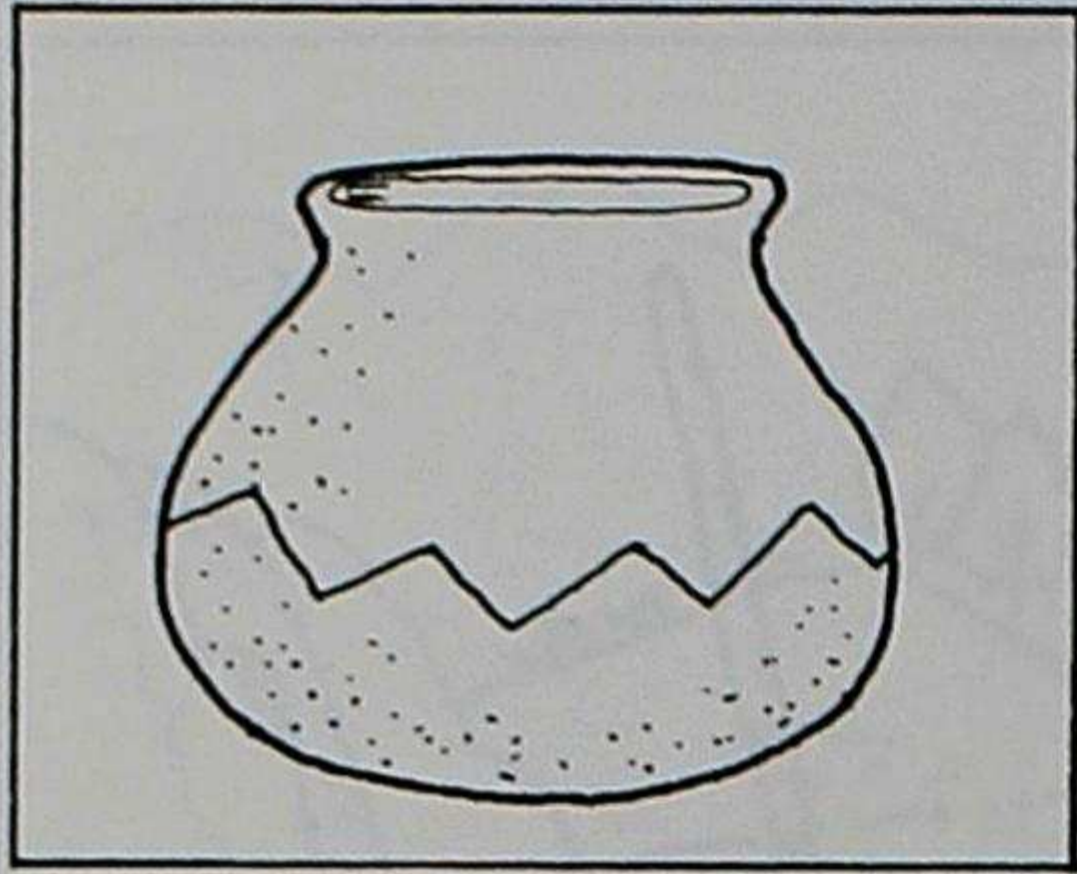

quincrai

shayac

siric

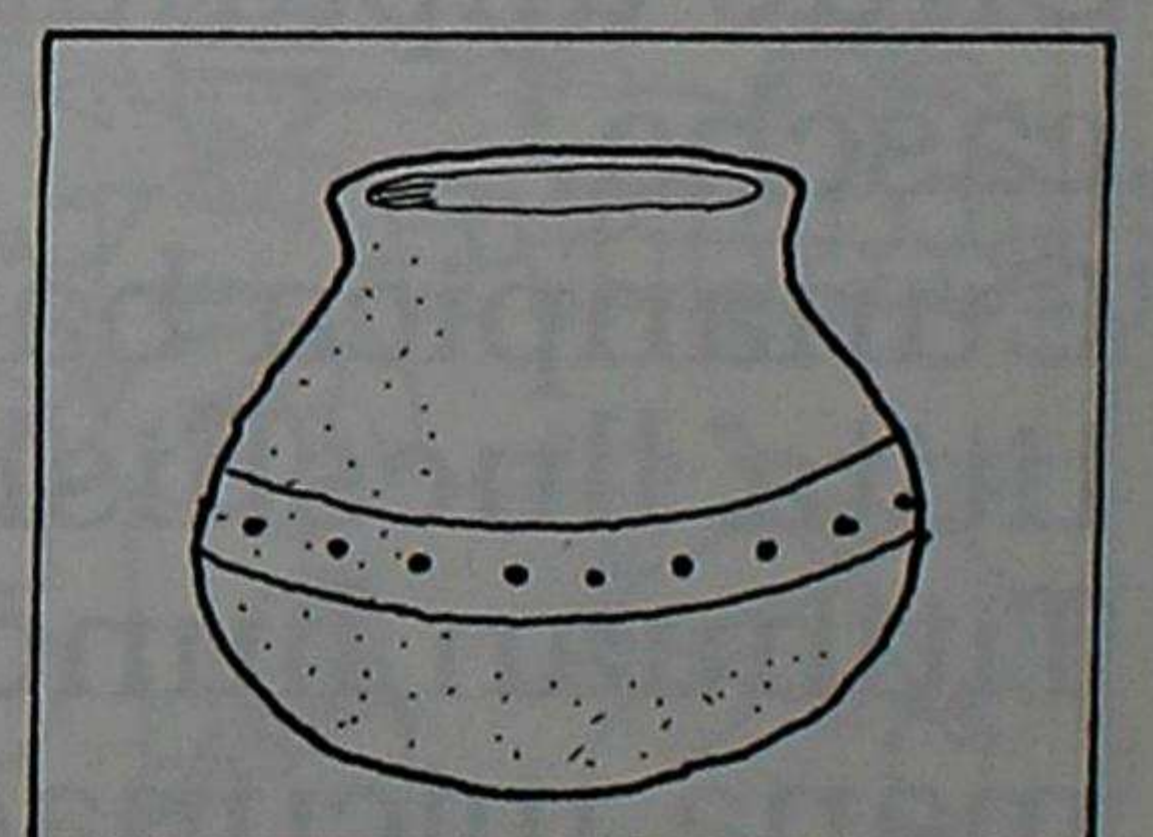
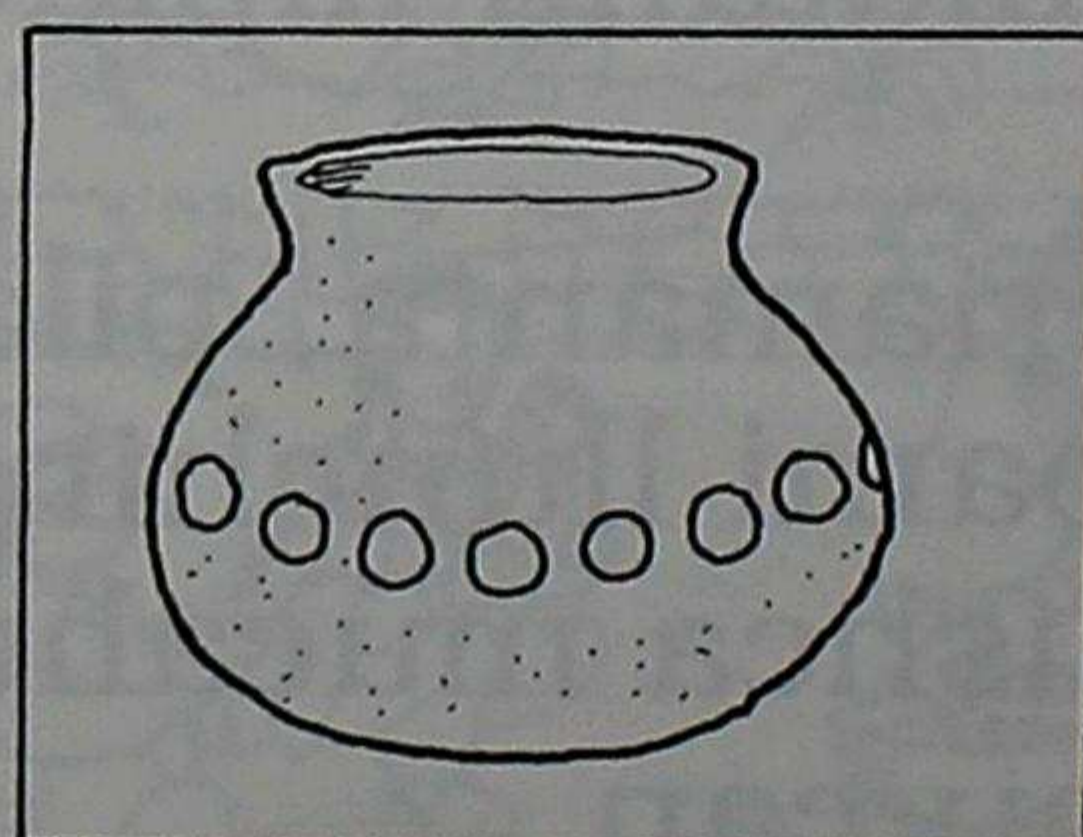
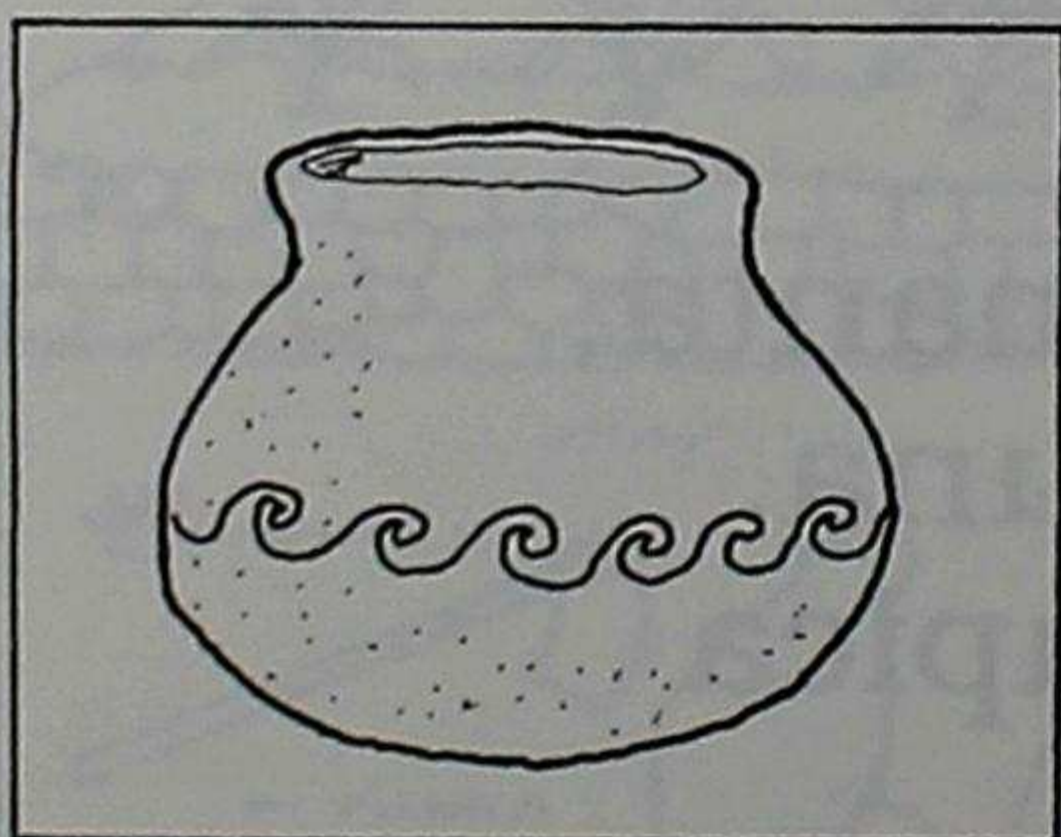

churu

runpa

iñu

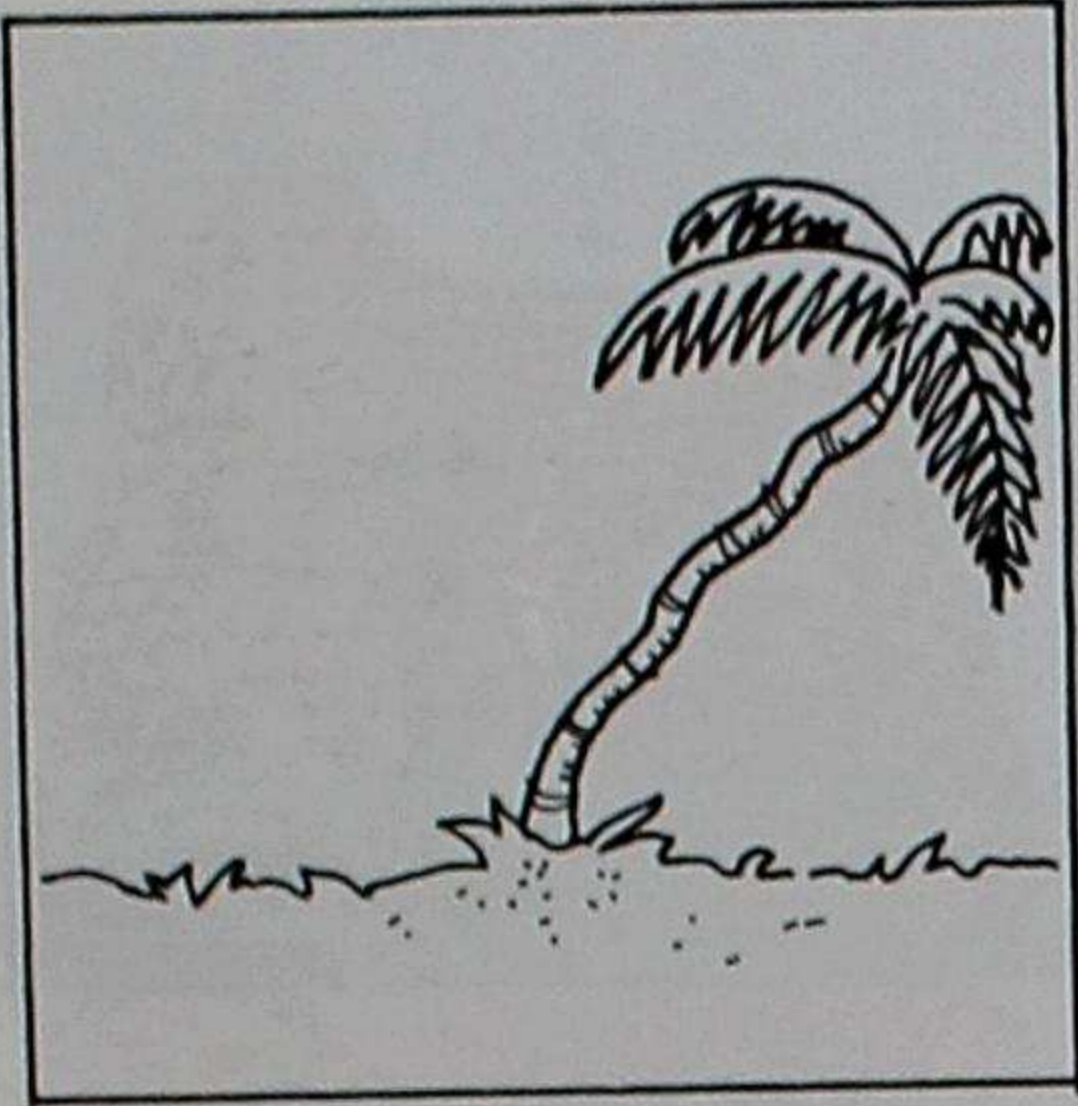
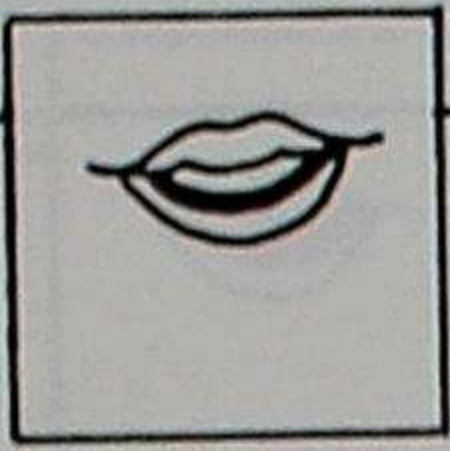

quincu

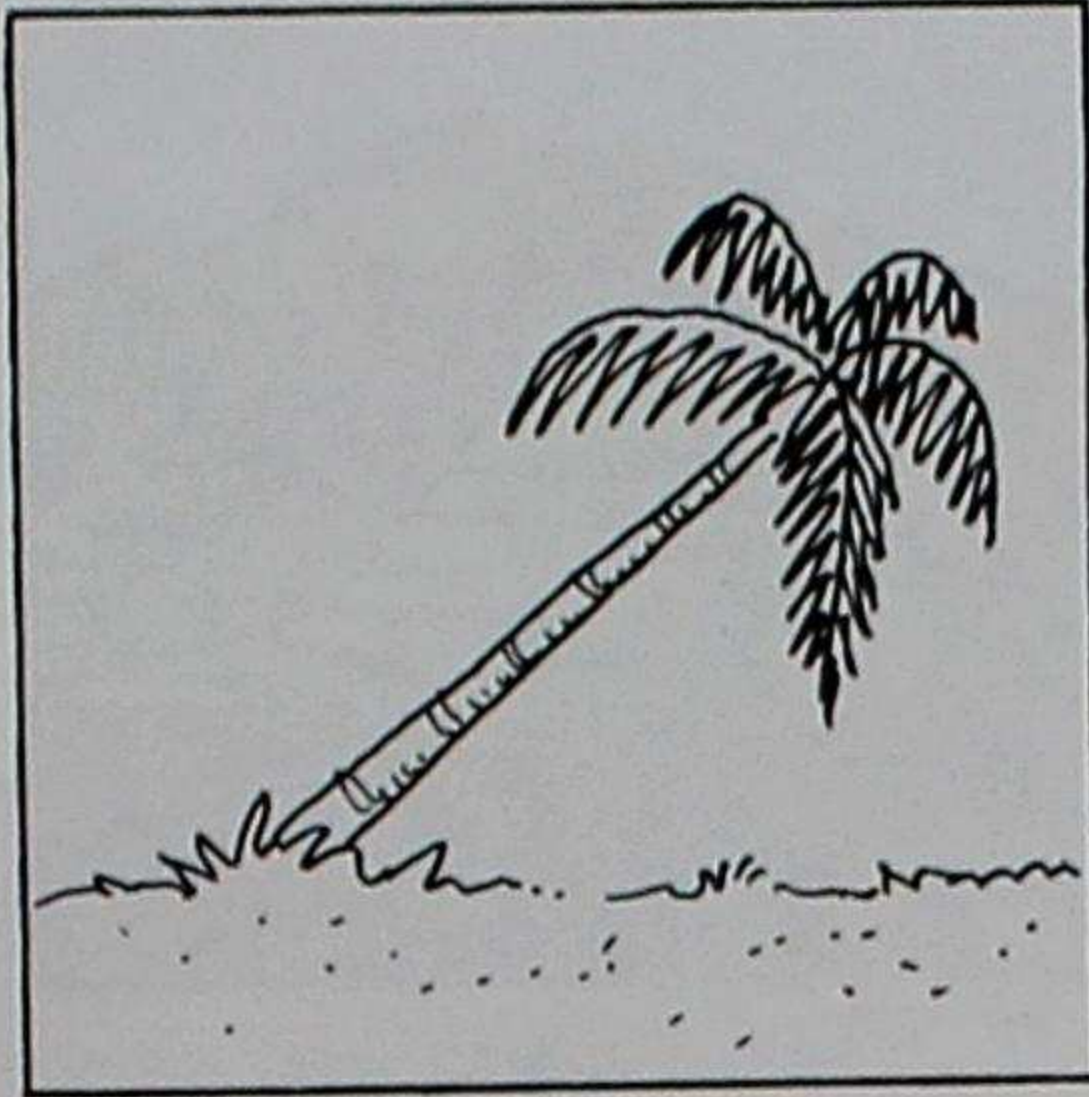

quincrai

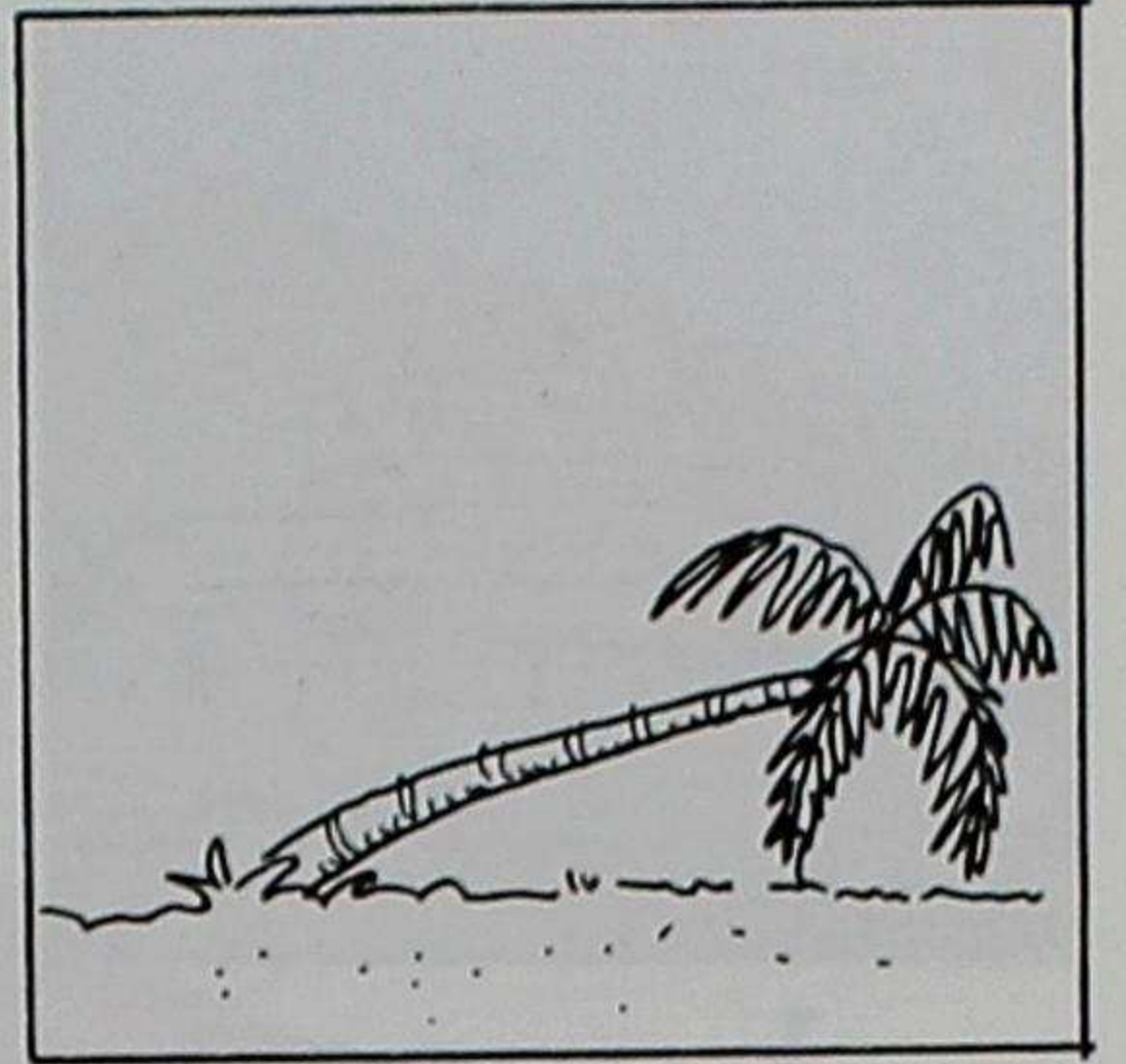

urmai

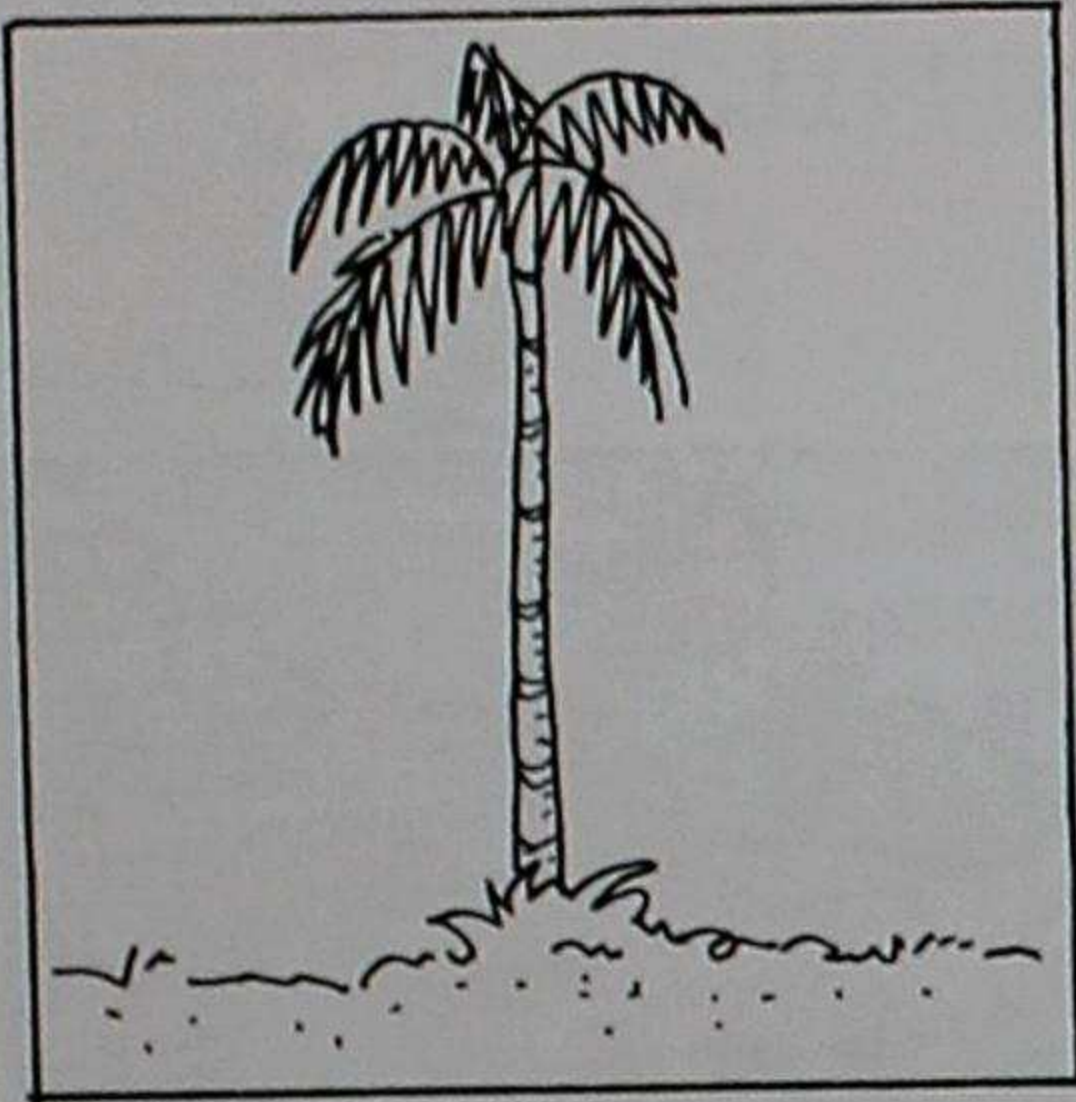

shayac

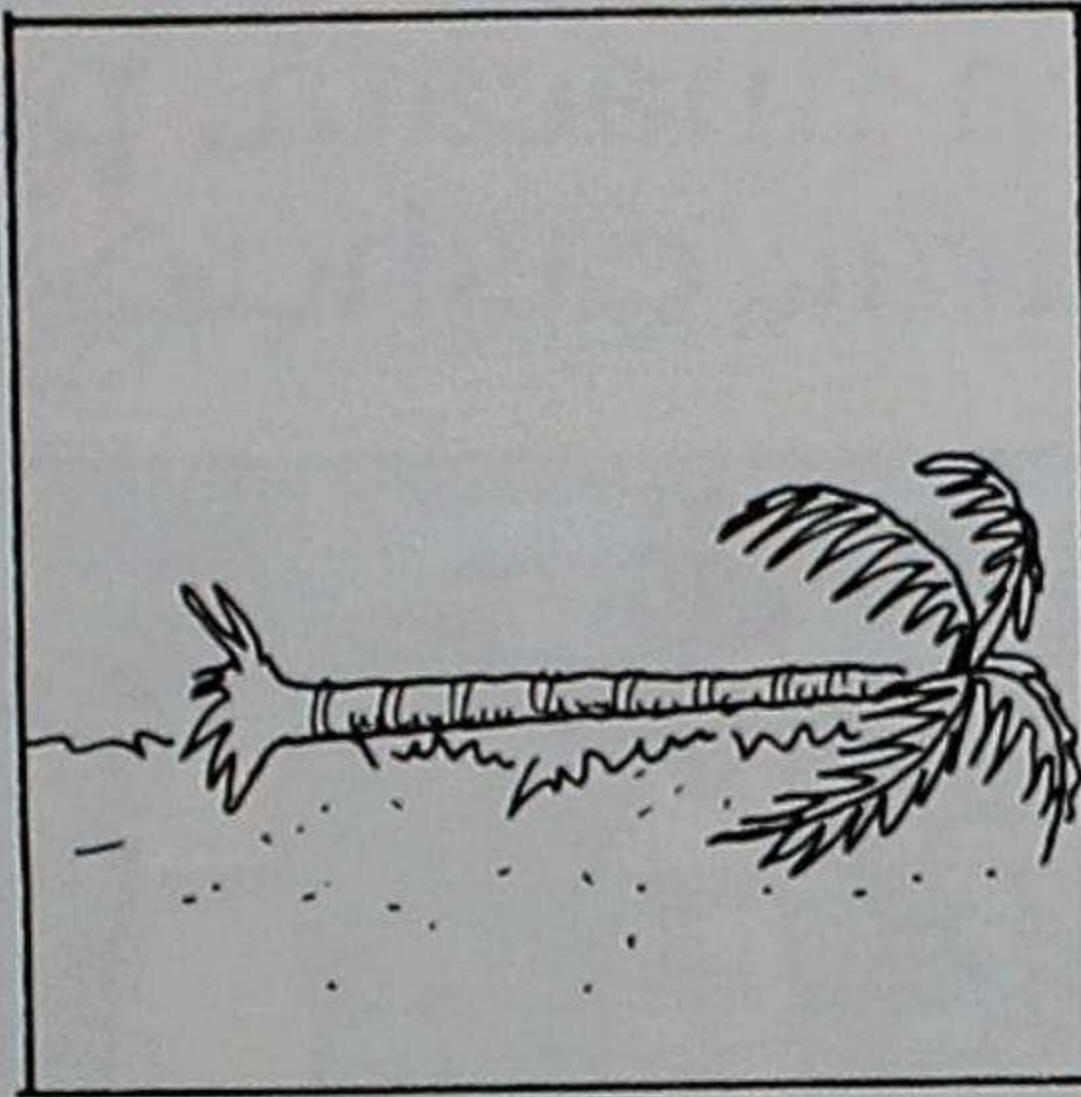

siric



chinpa

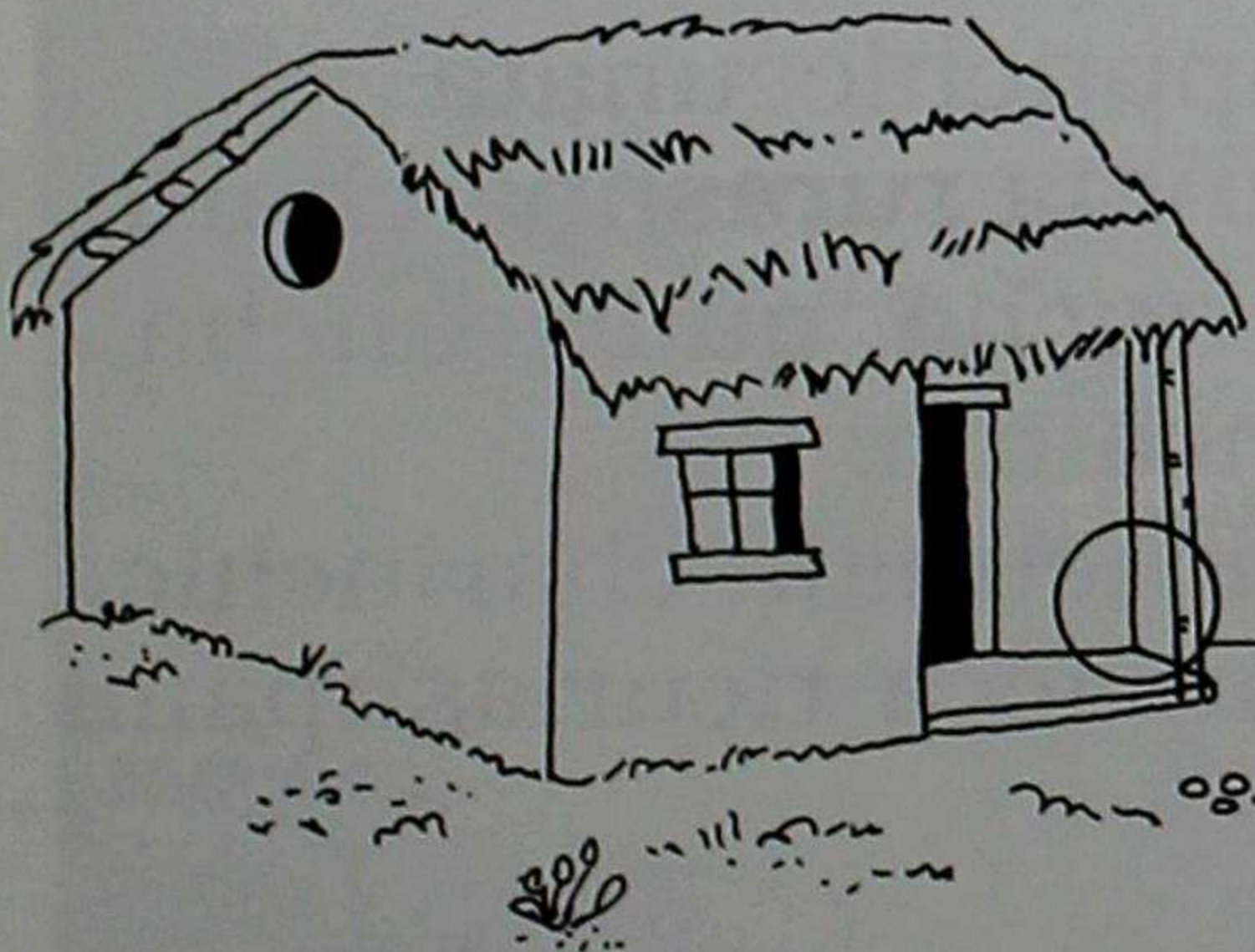

cuchu

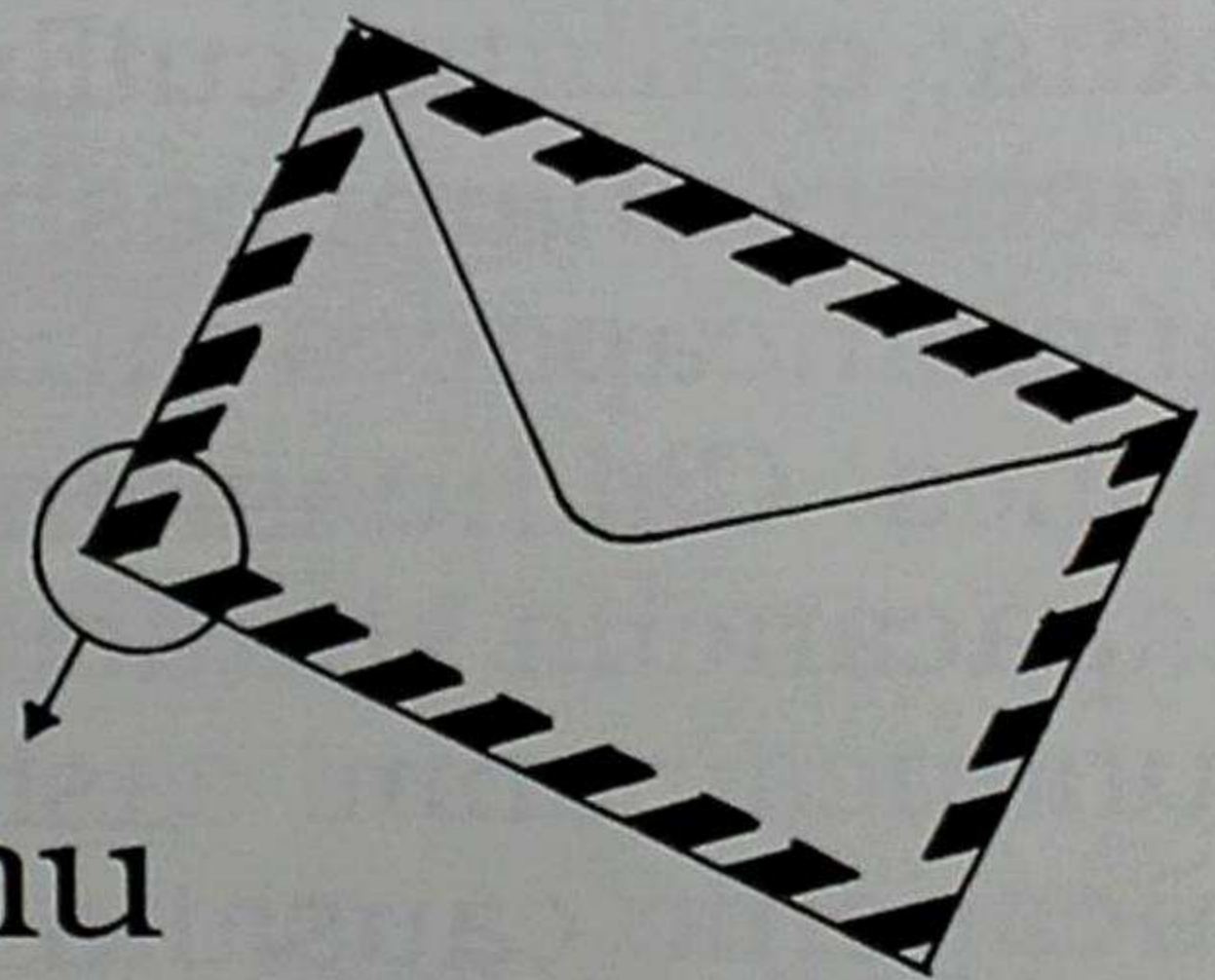

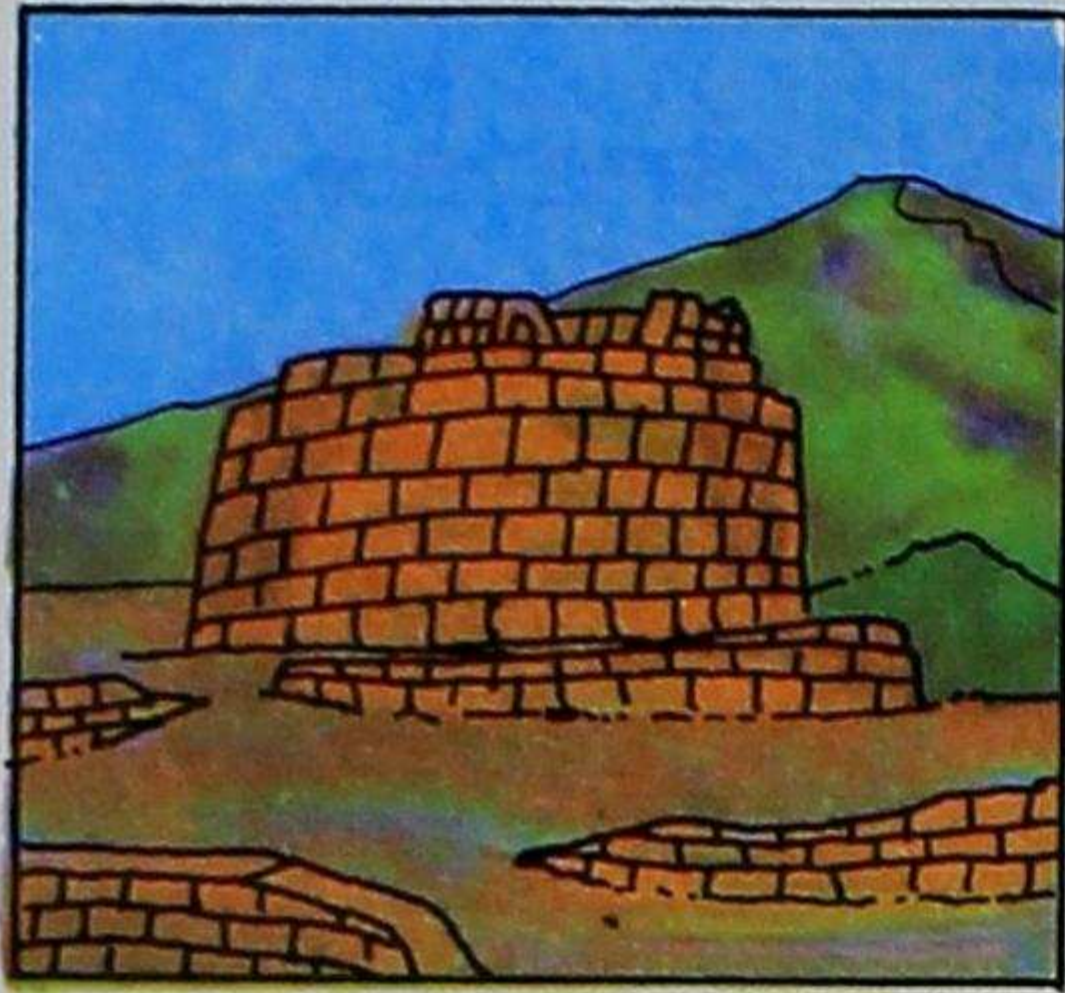
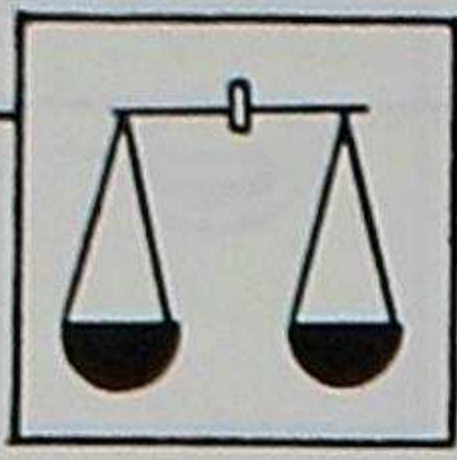

huaca

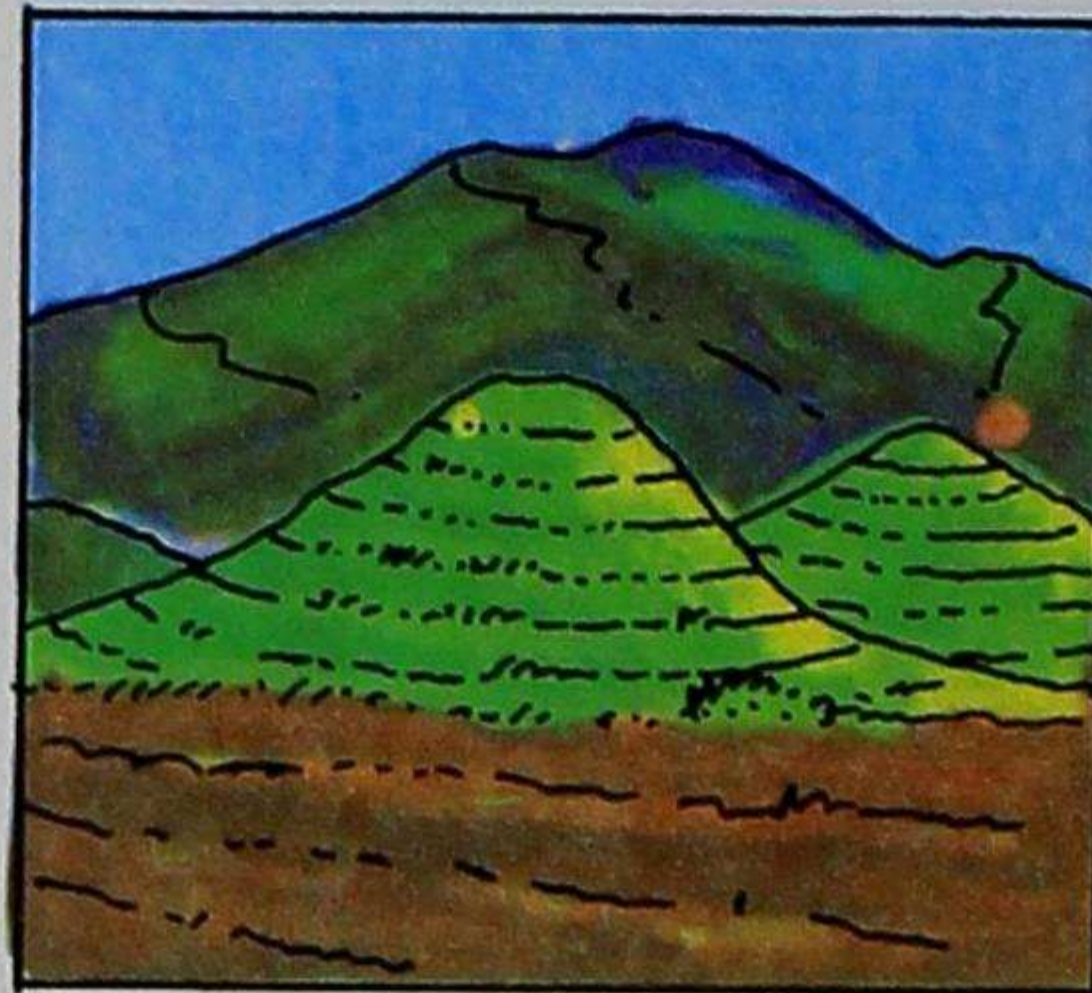

tula



pucara

Ñaupapachapica huacata, pucarata  
tulatapashmi rurac cashca.

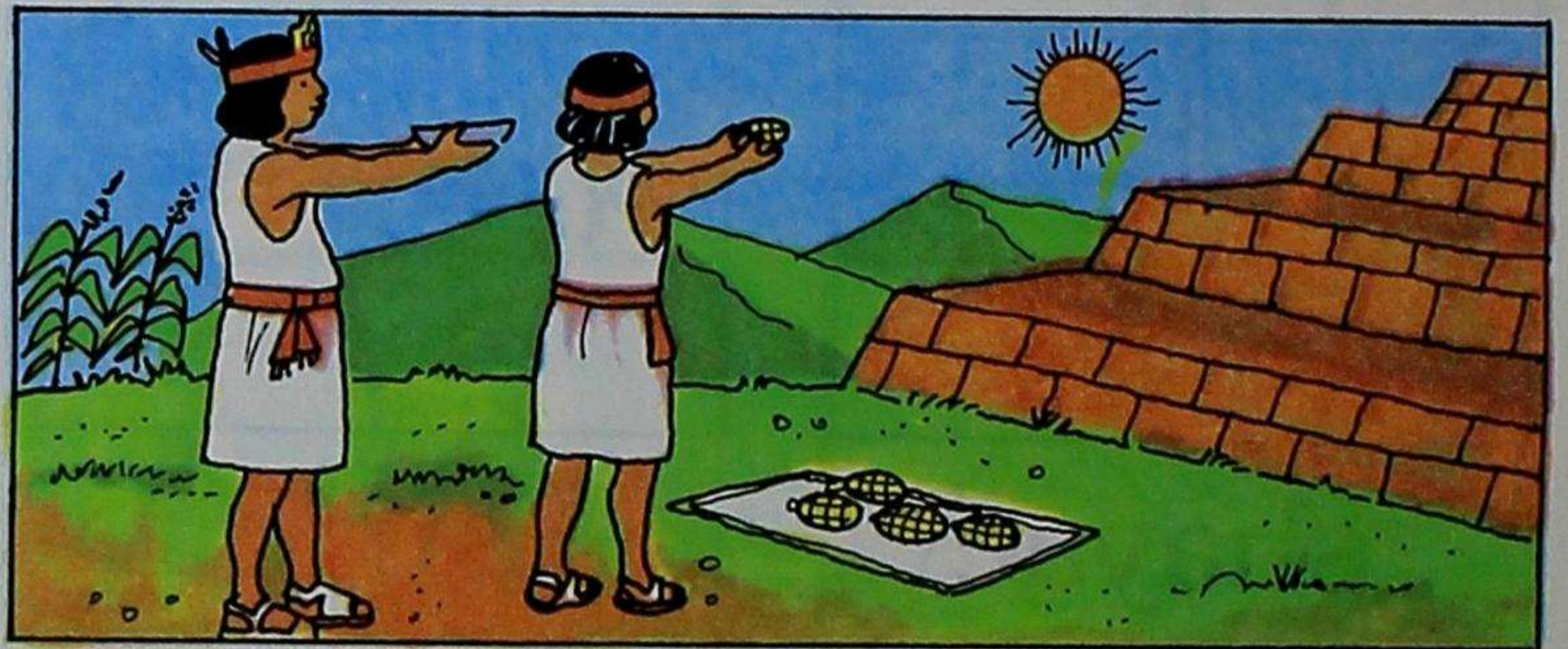
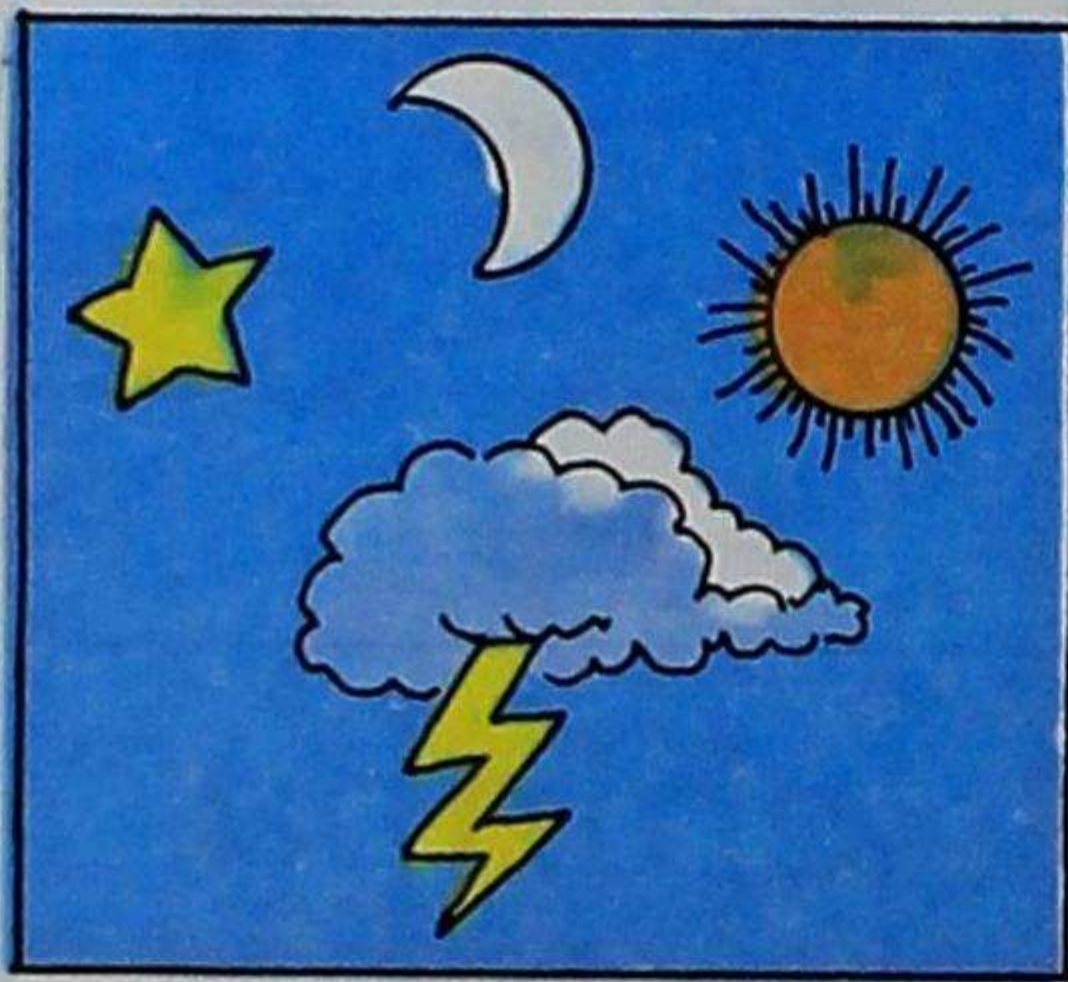

Intita, quillata, cuillurta, illapatapash  
muchaccunami cashca. Chai apunchiccunata  
muchancapacca jatun huasicunata rurashpa charic  
cashca. Cai huasicunaca curi cancha, quillacancha  
illapacancha shuticunami cashca nin.  
Cunancamanmi cashna rurashcacunata charinchic.  
Ñucanchic causaita ricsichincapacca ricuriashpami  
charina canchic.

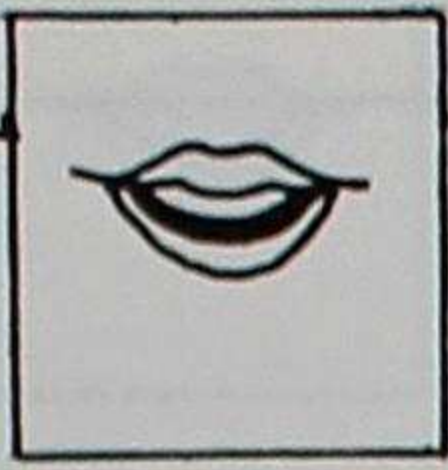

# Ñuca huasicu

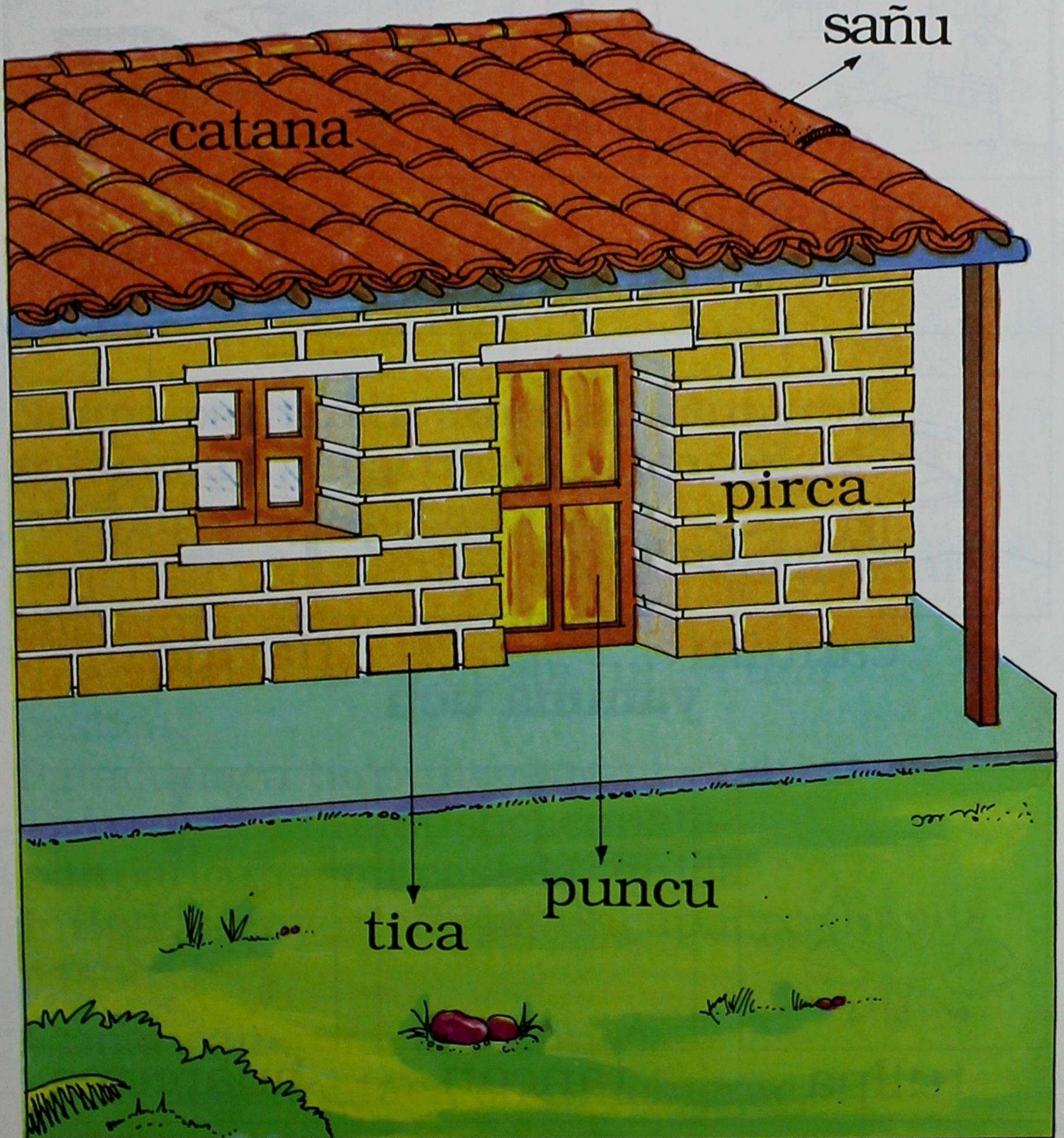

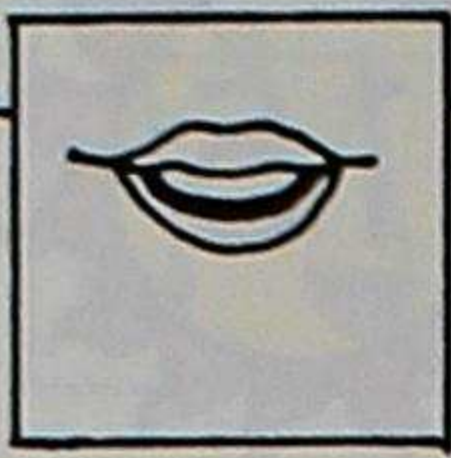

# Huasimanta

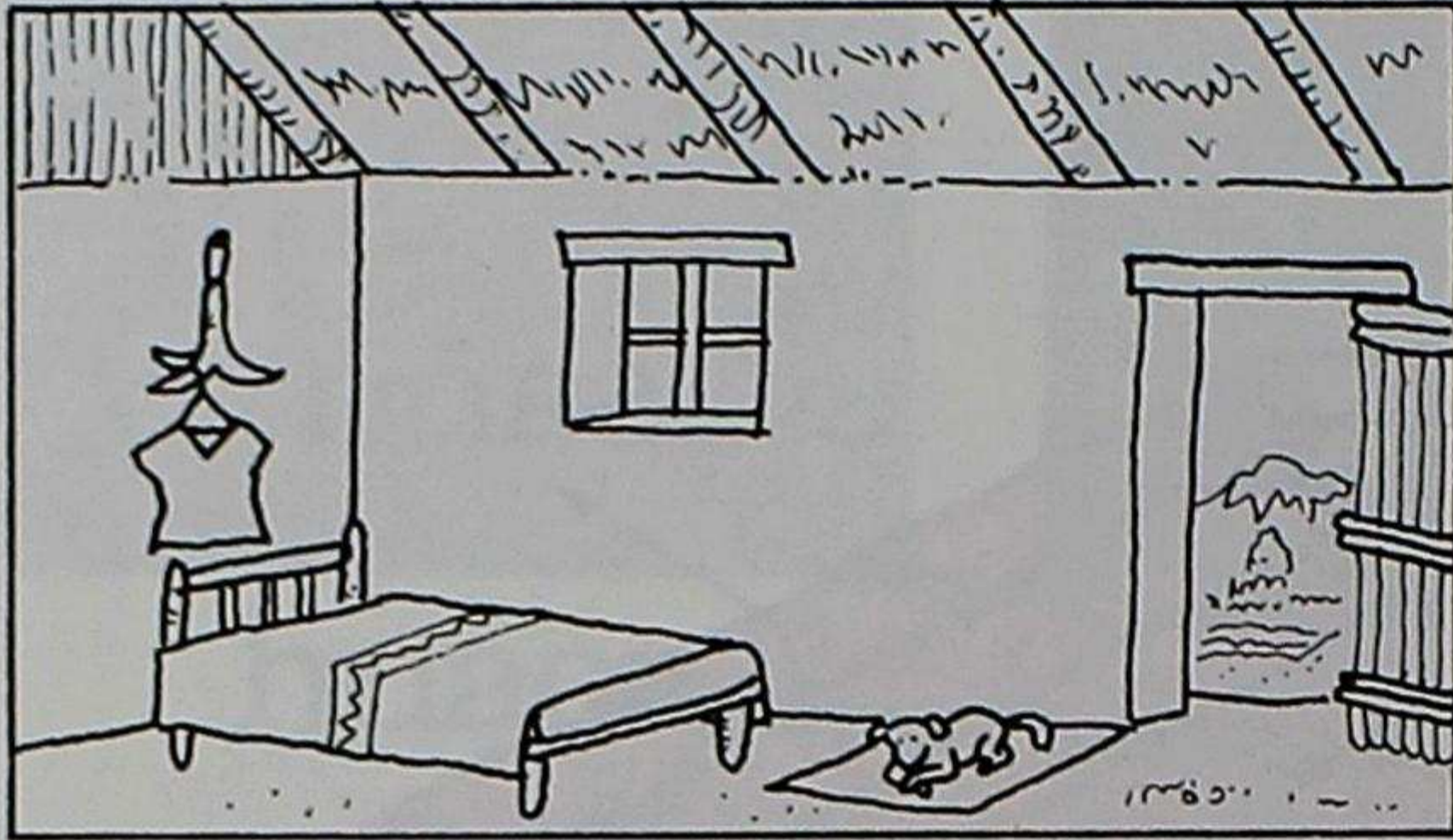

huasi ucu

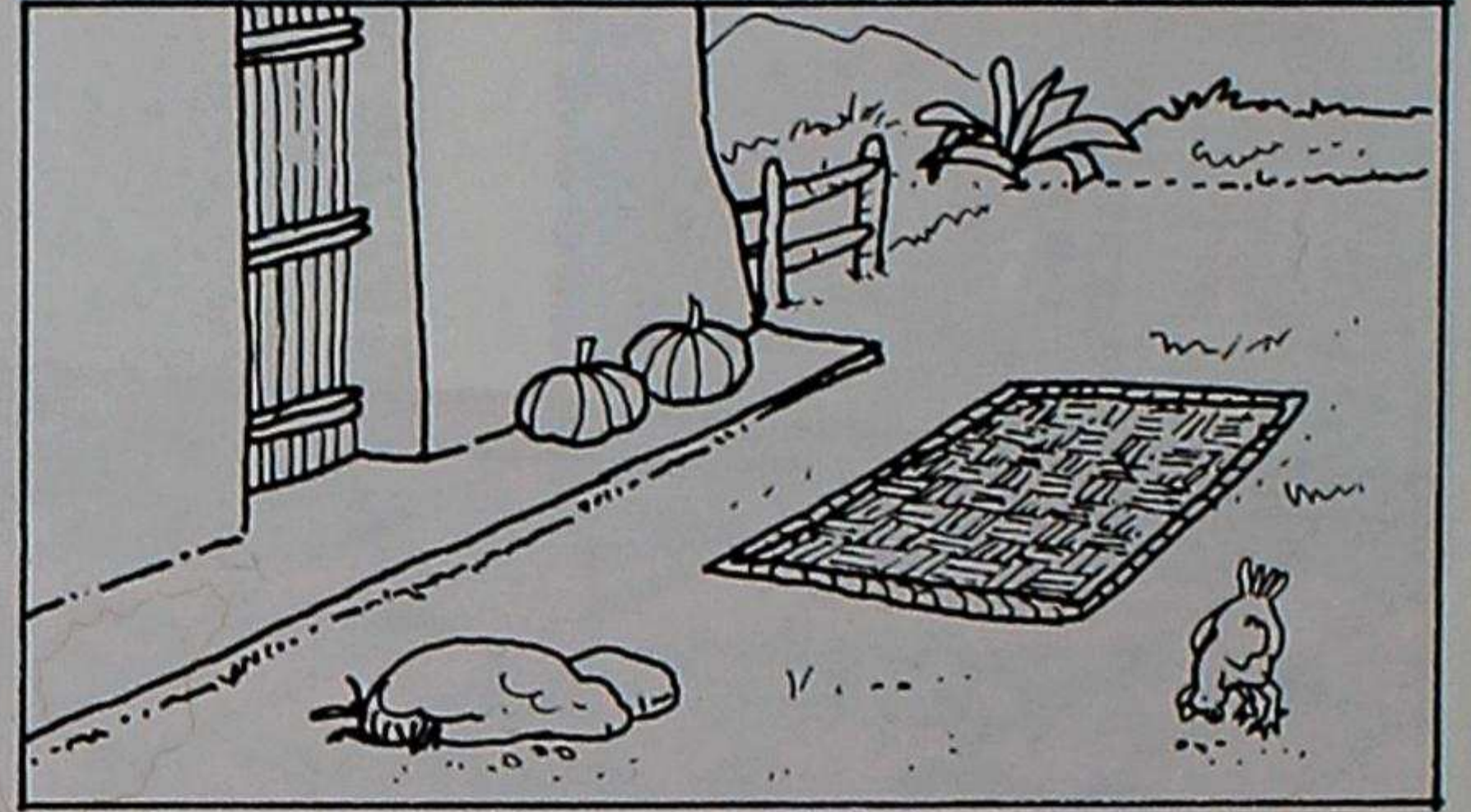

cancha

## puñuna ucu

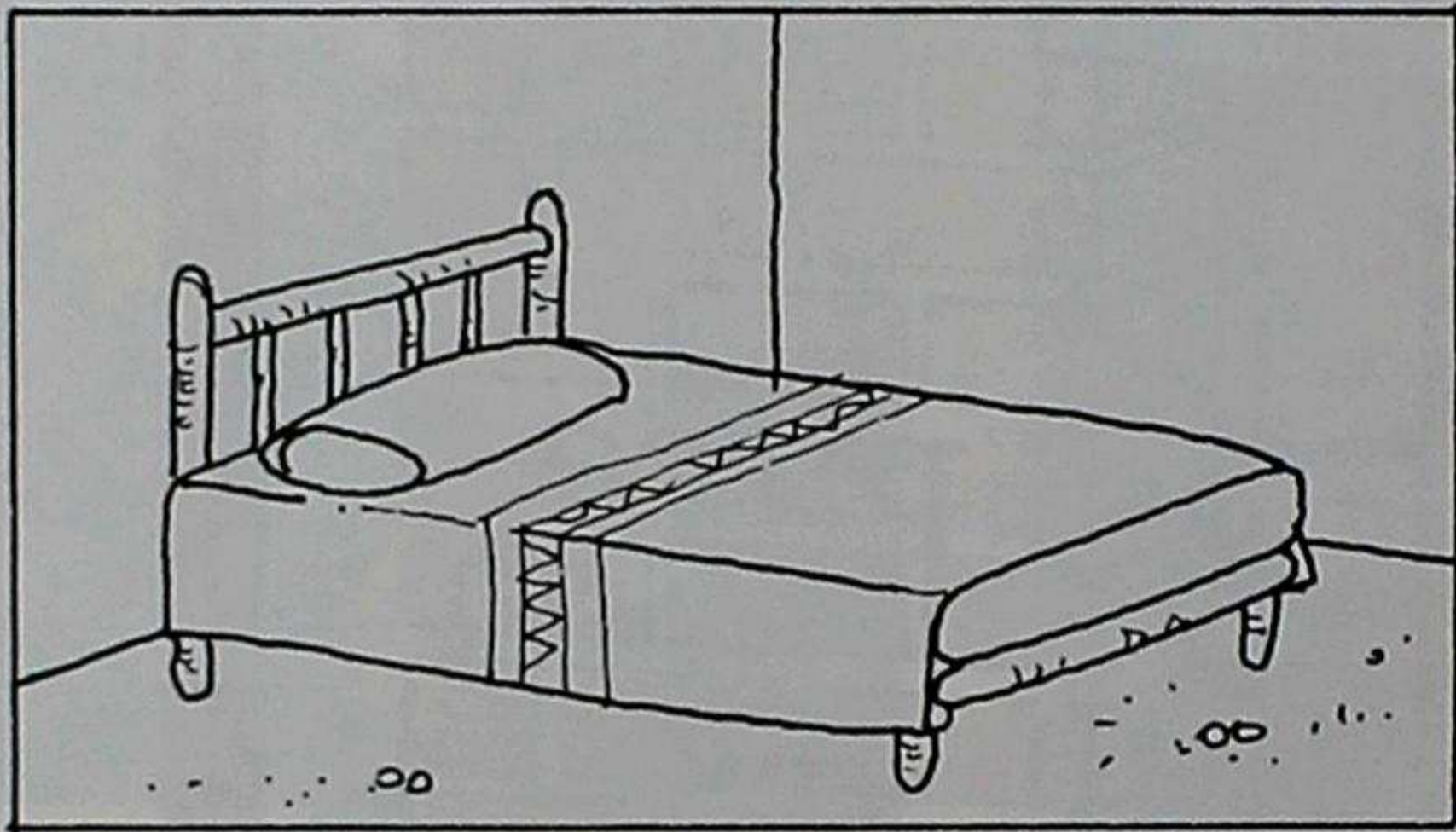

cahuitu

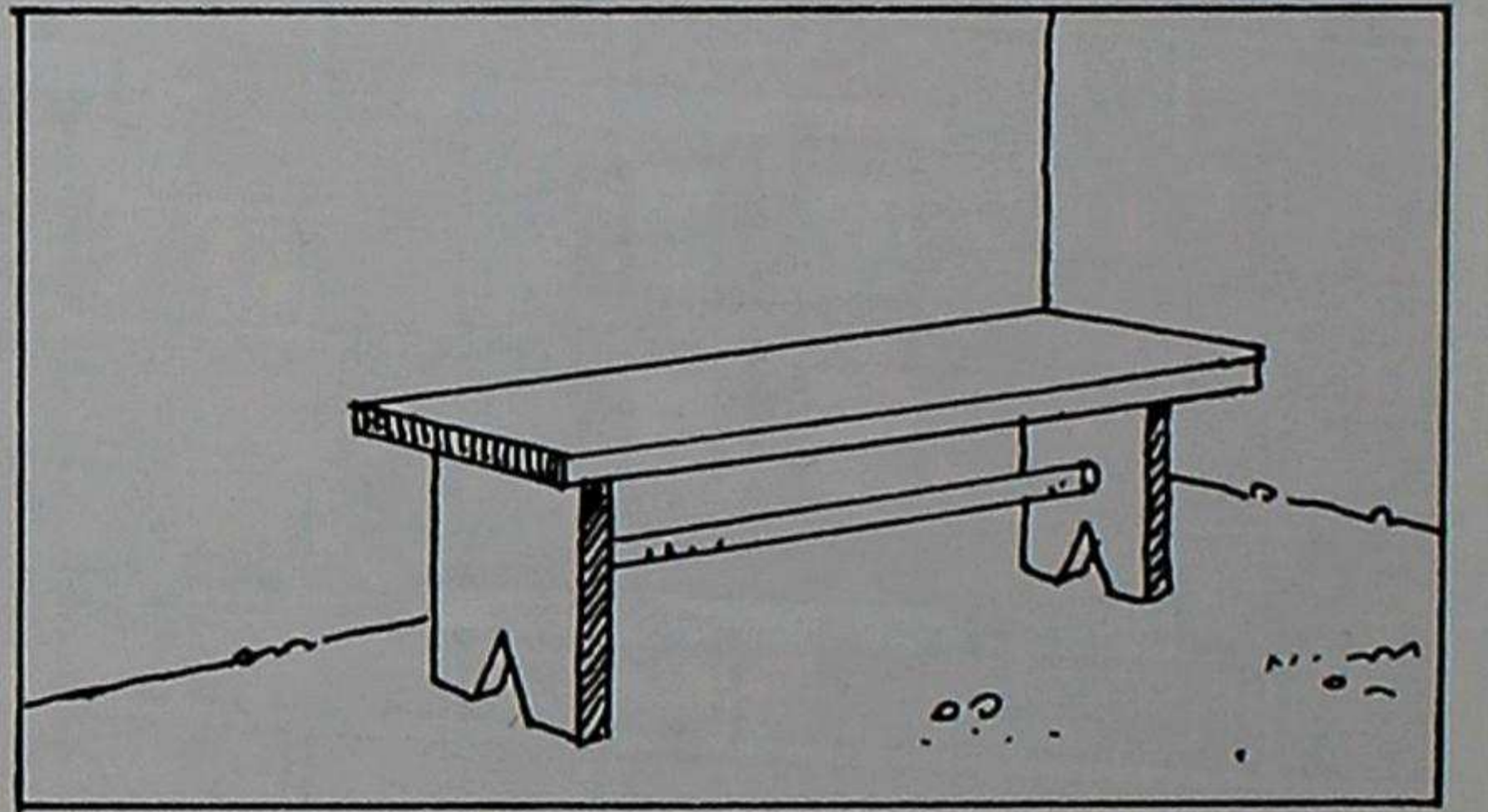

tiarina

## yanuna ucu

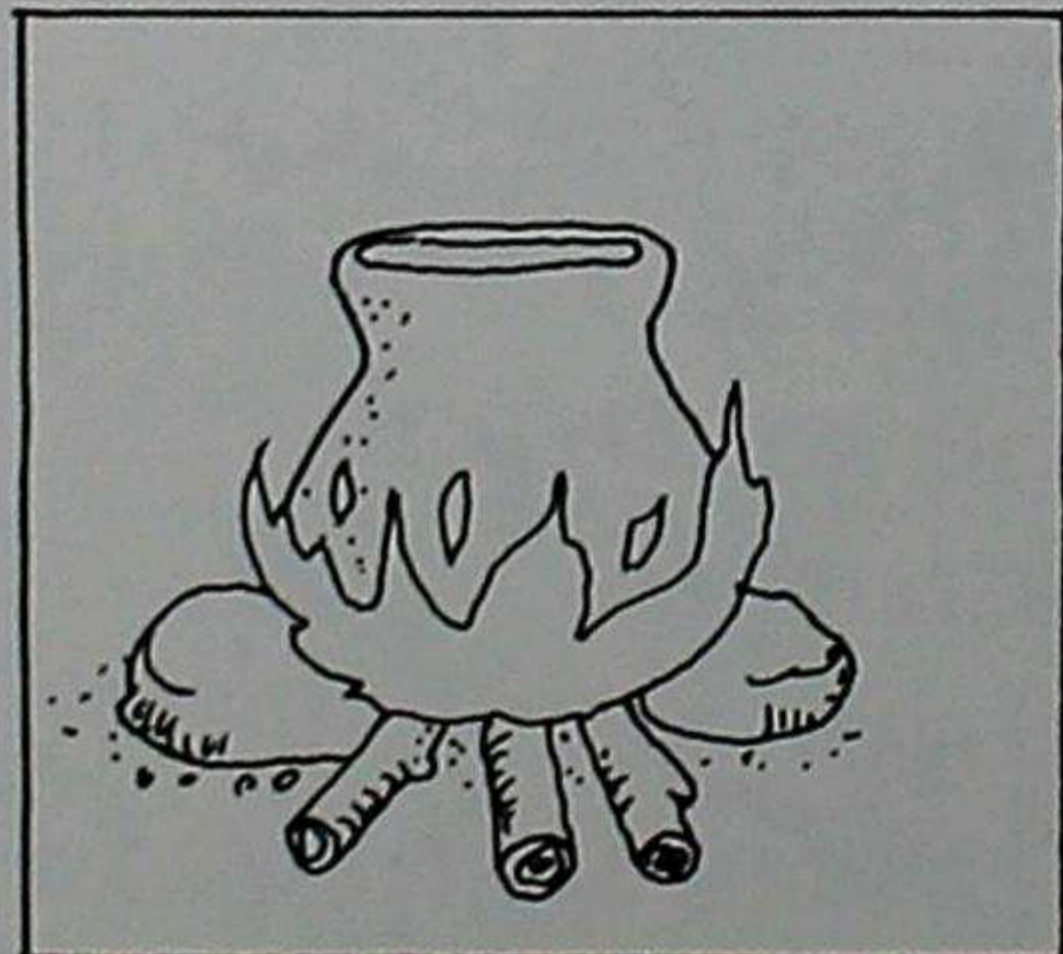

tullpa

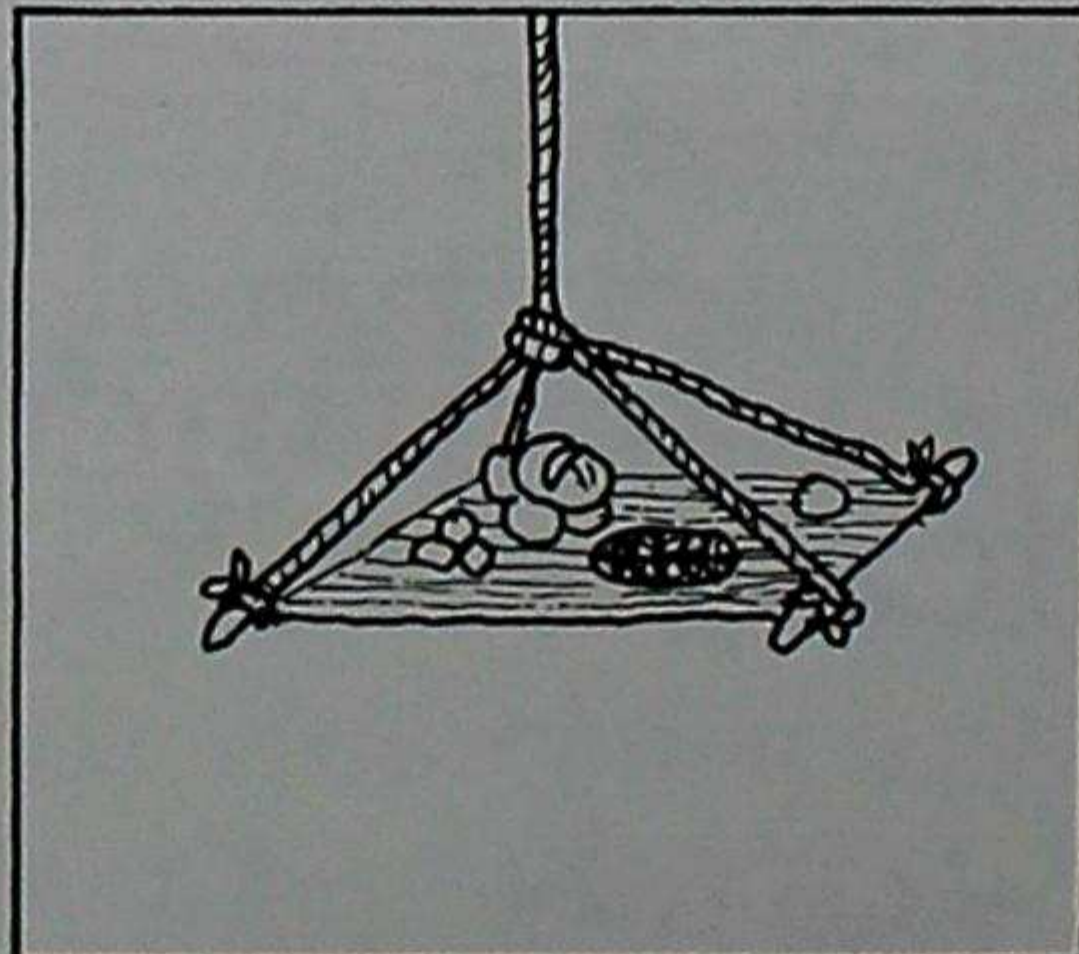

tancan

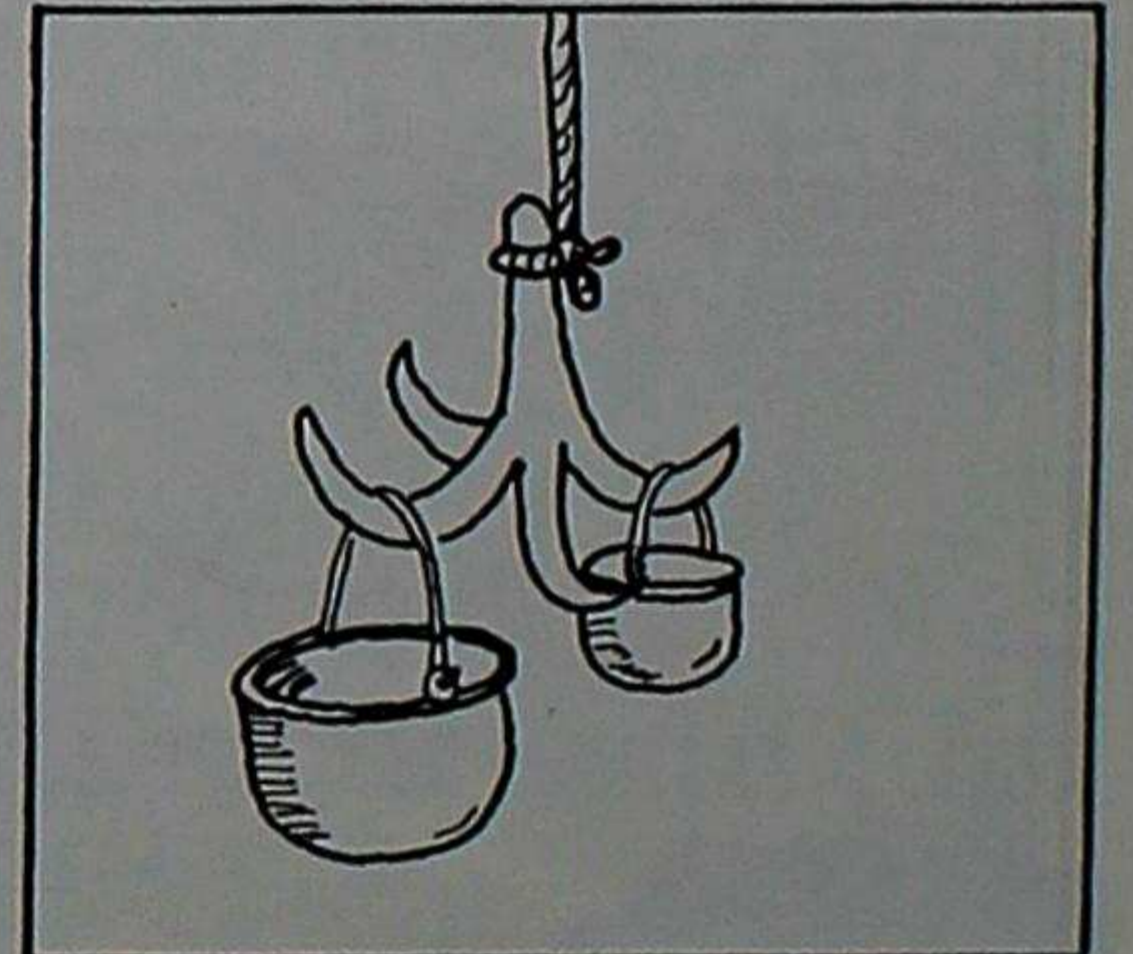

huarcuna

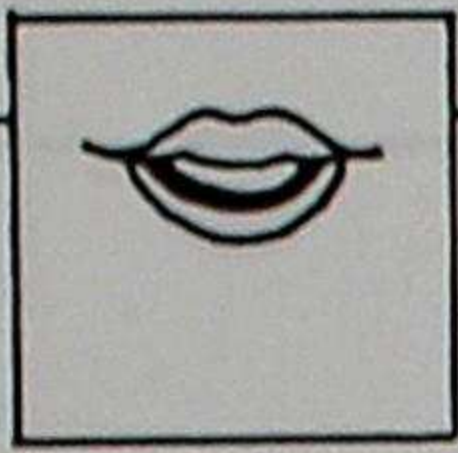

## Cochasquimanta rimai

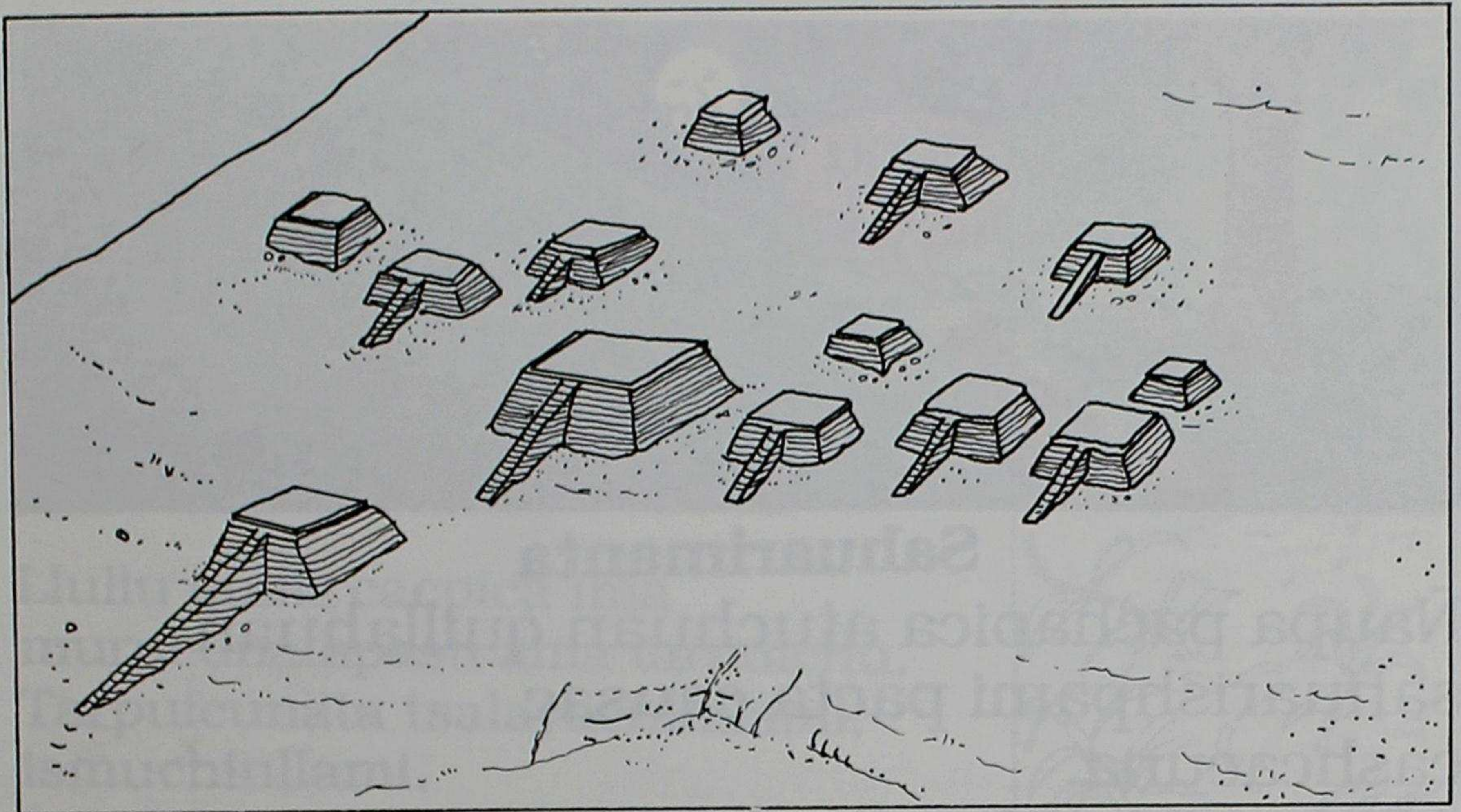

Ñaupapachapica tauca aillacunami  
patacunata, tulacunata, larcacunata  
rurashpa causac cashca.

Mojanda urcusiquipi causac Cochasquí  
aillucunapashmi patacunata,  
tulacunata, larcacunata ruraccuna  
cashca.

Patacunaca tarpuncapacmi cashca.

Tulacunaca huañushcacunata  
panpancapacmi cashca, quilla  
intipash cuyuricta tupuncapacpashmi  
cashca.

Cunancamanmi cai sumac  
rurashcacunataca charinchirac.

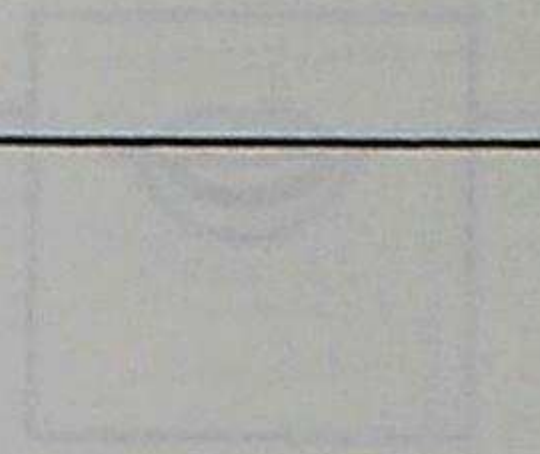
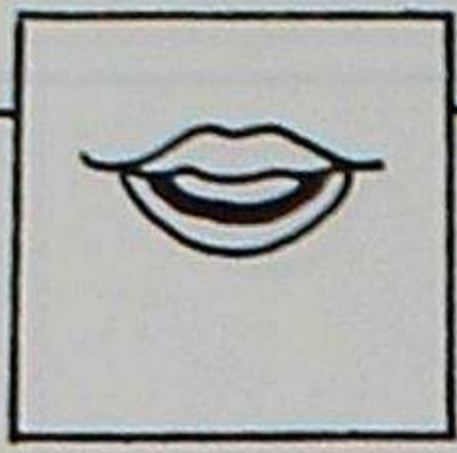

### Sahuarimanta

Ñaupapachapica atuchuan quillahuan  
sahuarishpami pacta causac  
cashcacuna.

Atucca shuashpalla causac caccpimi  
mama quillaca paita saquishpa  
jahuaman rishca.

Chaimanta mama quillaca, atuc ama  
shuachunmi tutapi punchayachin nin.

Shinallatac atucca, mama quilla  
llucshicpica shamuiyari nishpami auu,  
auu nin.

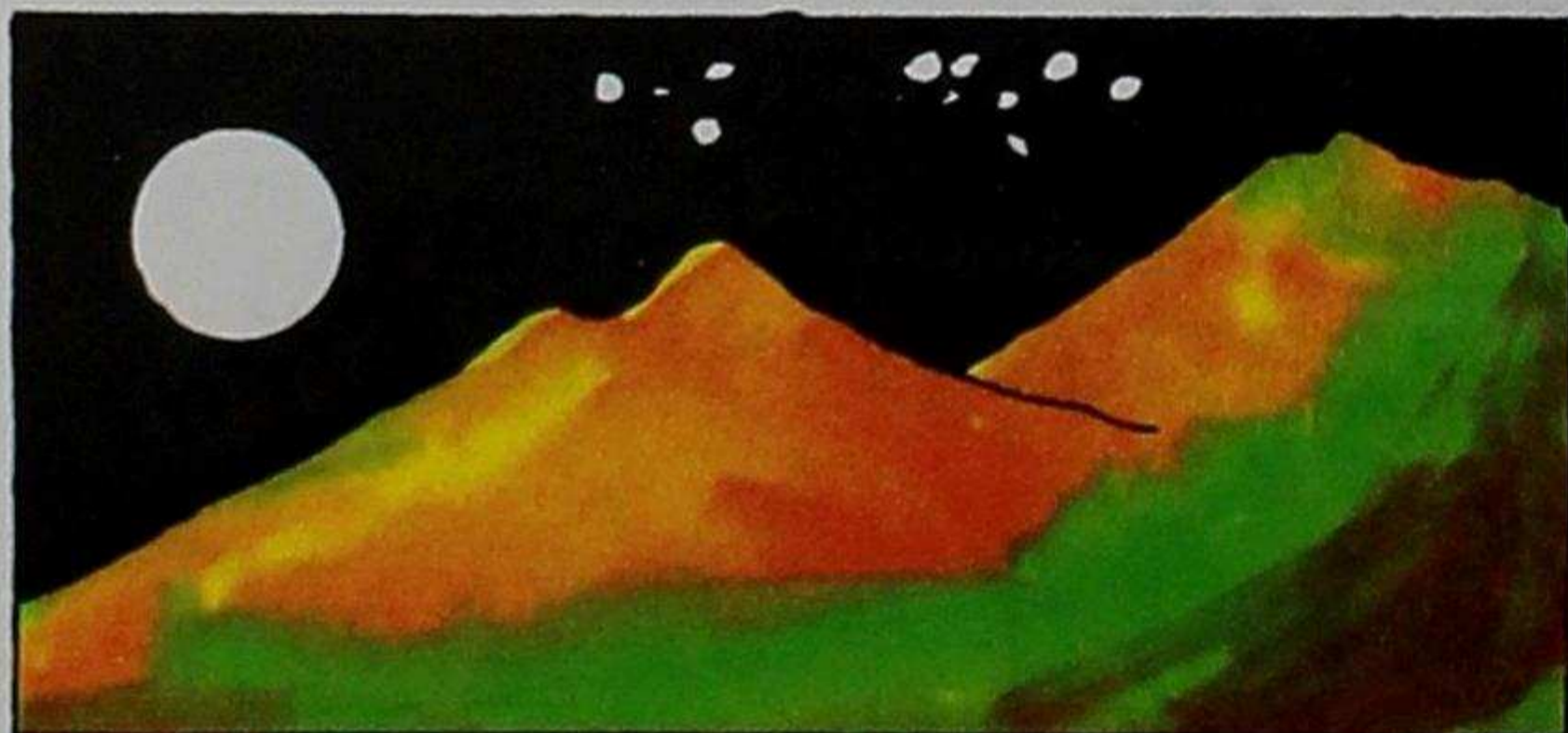

pura quilla

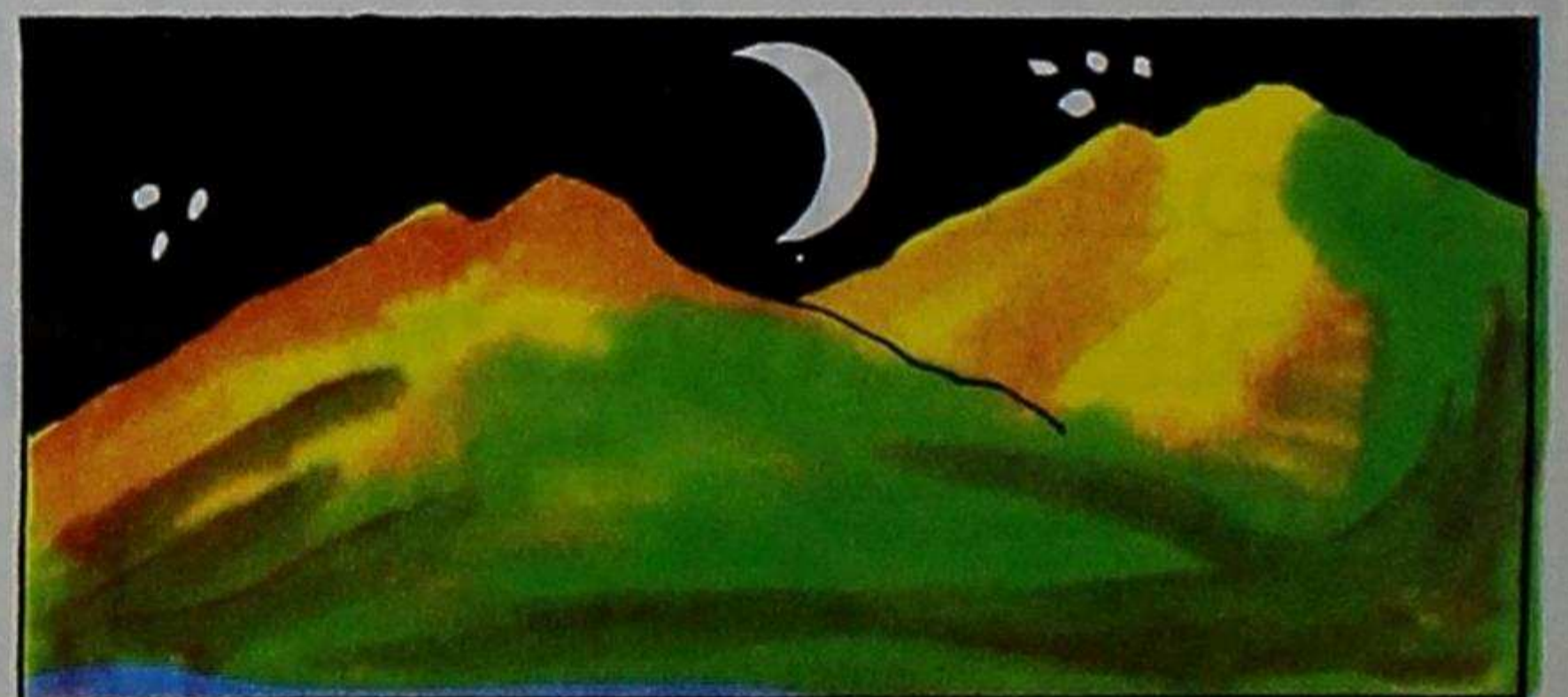

llullu quilla

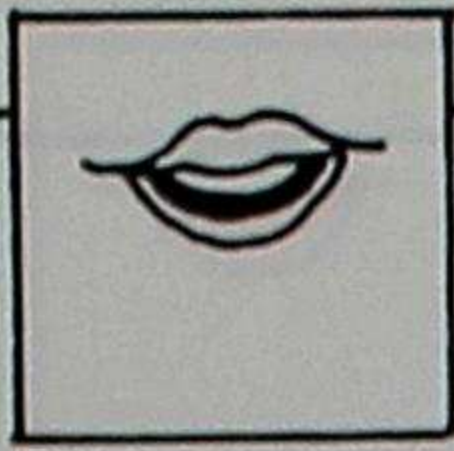

Llullu quilla tiyacpica ama  
huasichichu.

Huasipac caspica susuncami.

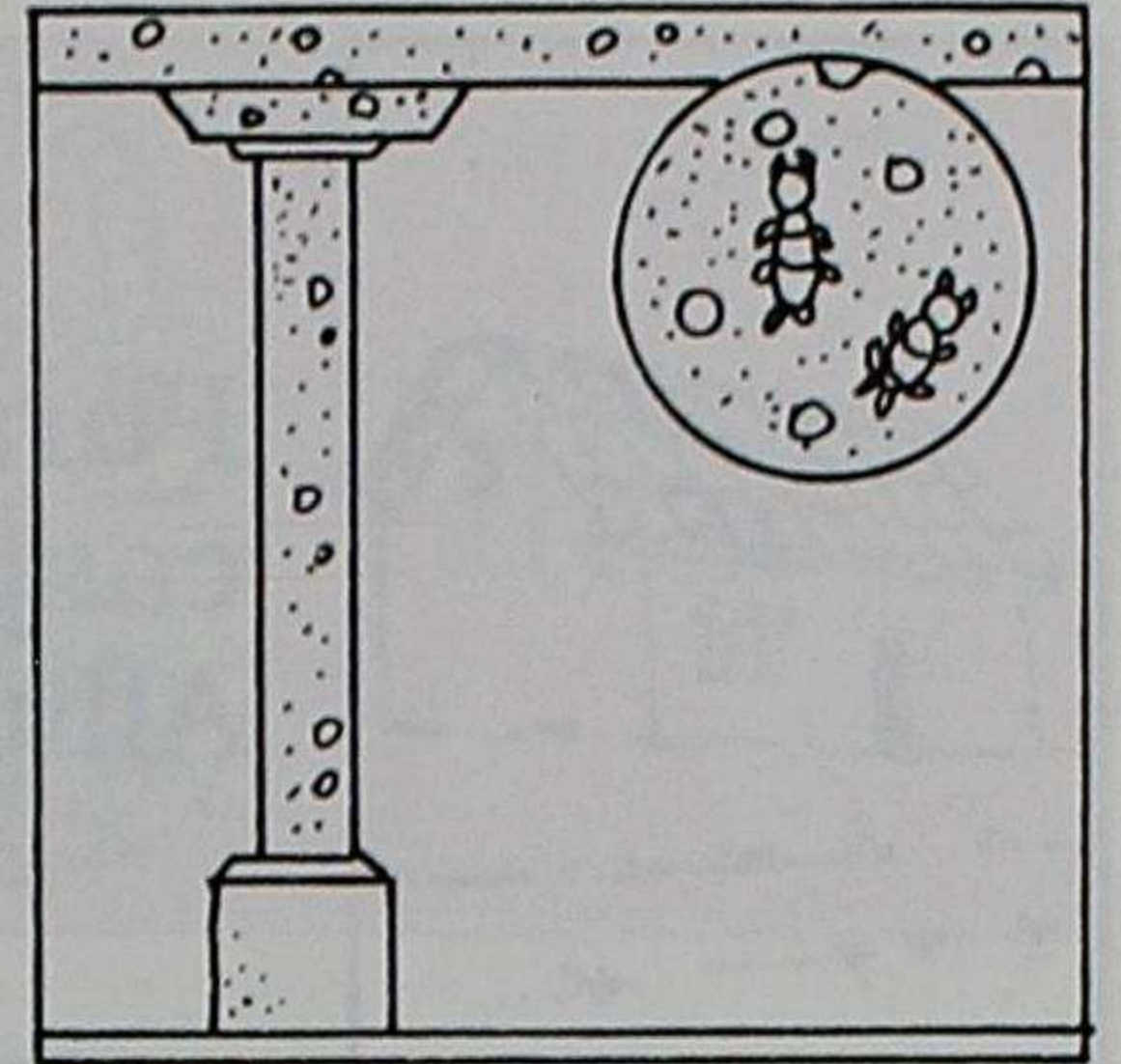

Llullu quilla cacpica ima  
murucunatapash ama tarpuichu.  
Tarpucunata tsalayachinllami,  
ismuchinllami.



Llullu quilla cacpica cari  
huihuacunapac luluntaca ama  
surcuichu. Paipac chucuri  
punchishpa huañunllami.

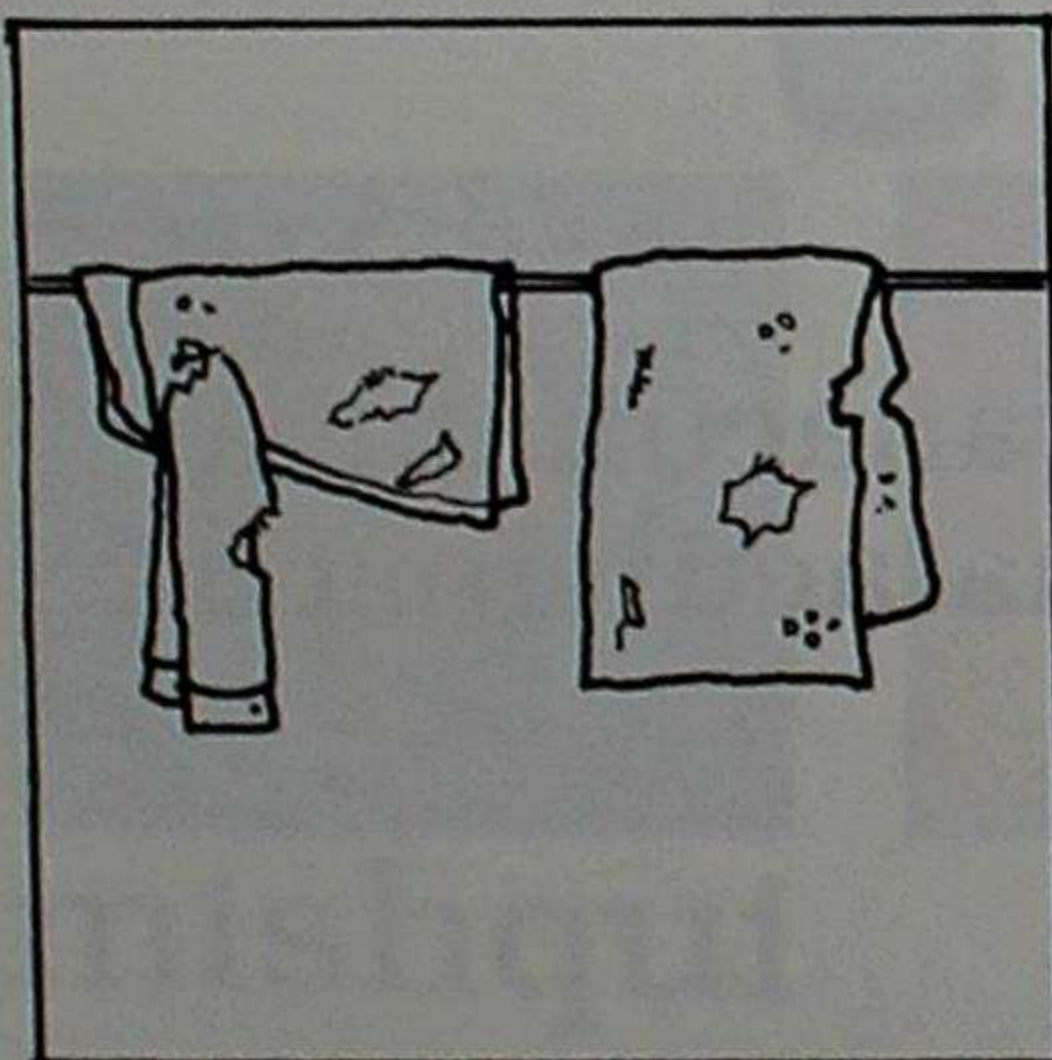

Llullu quilla cacpica churana  
cunataca ama tacshaichu.  
Churanacunaca ismunllami



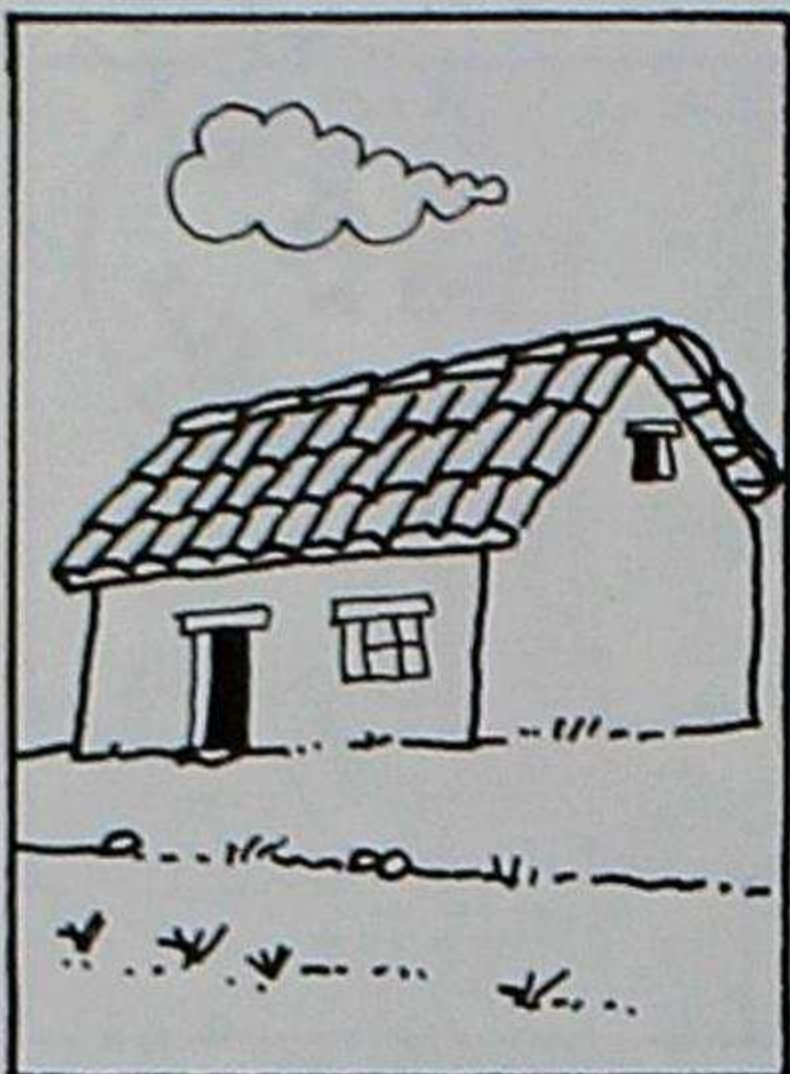
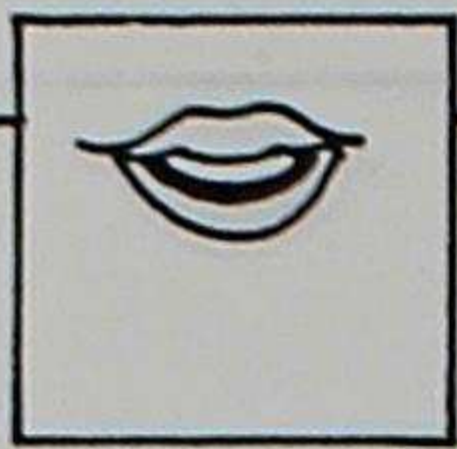

Pura quilla cacpica huasipac  
caspicunata cuichuilla.  
Allipachami can.



Pura quilla cacpica ima  
murucunatapash tarpuilla.  
Sumactami pucun.



Pura quilla cacpica cari  
huihuacunapac lulunta surcunallami.  
Sumactami huirayan.



Pura quilla cacpica churanacunataca  
tacshanallami, achca huatacunapacmi  
alli can.

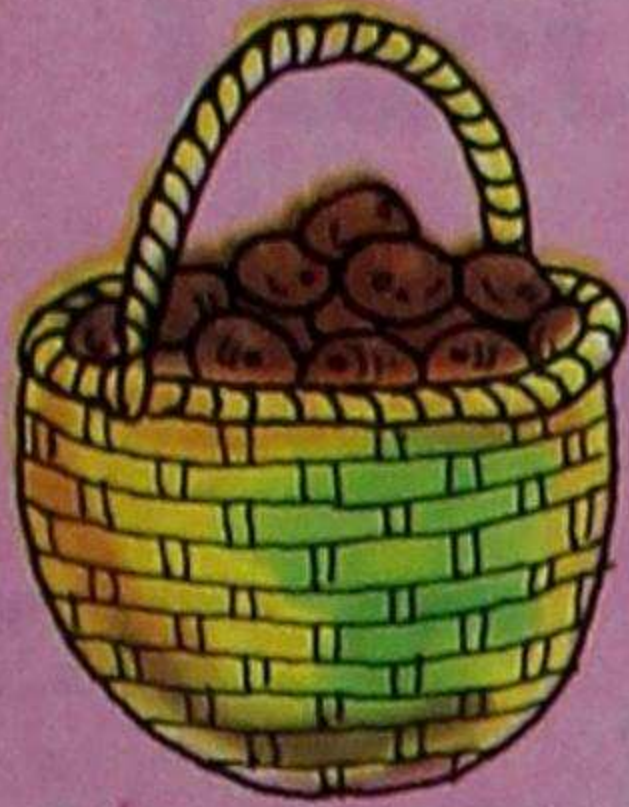
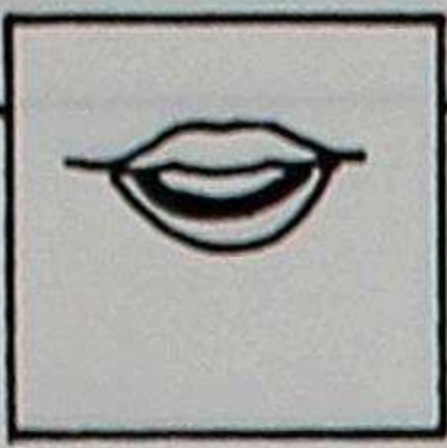

junta



illac

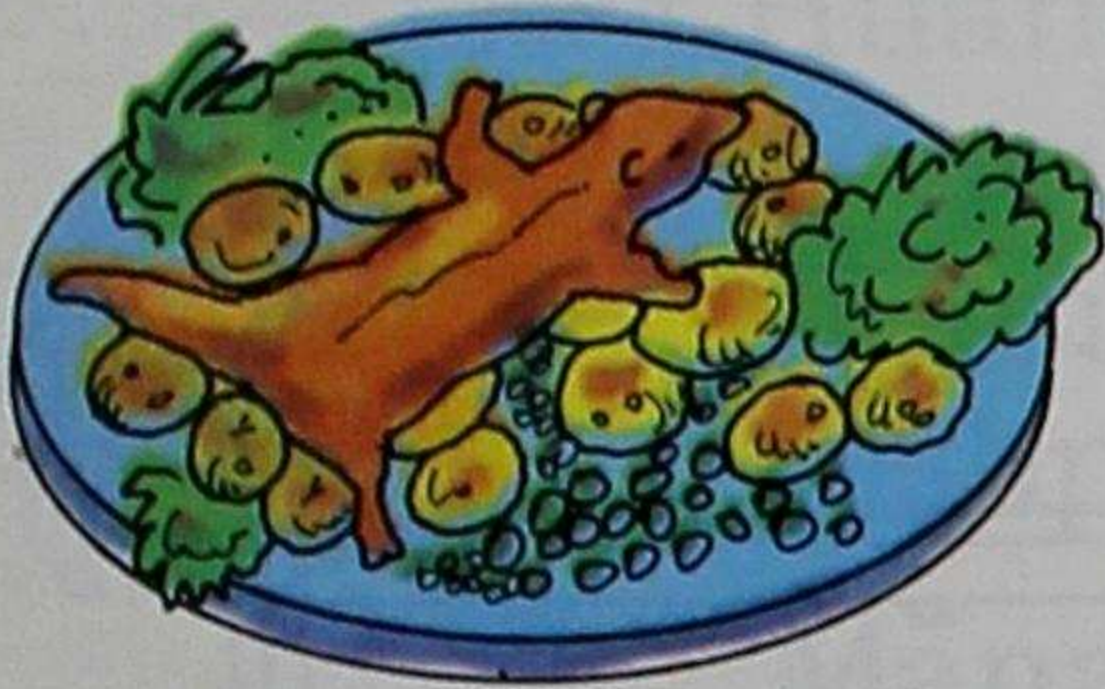

achca

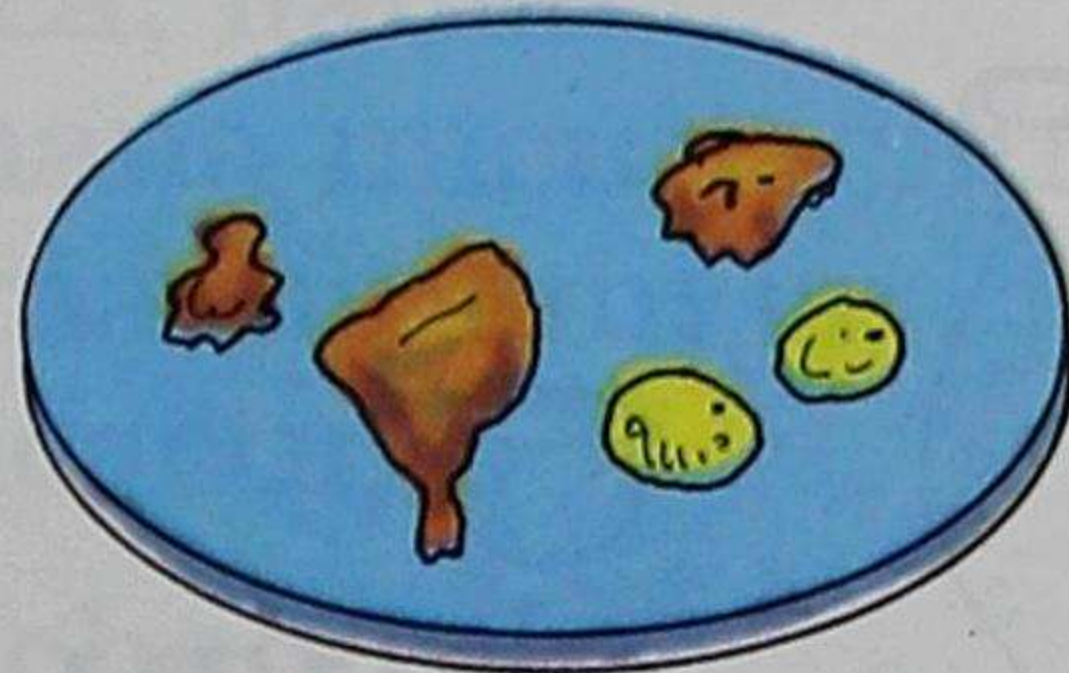

piti

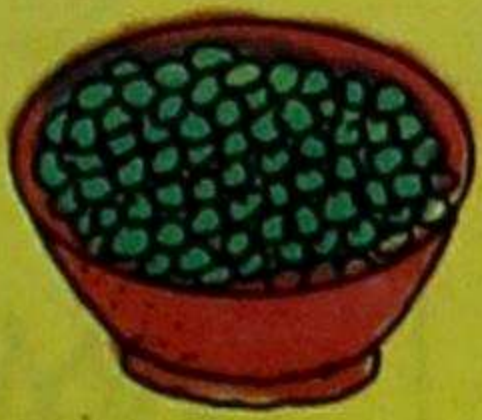

tucui

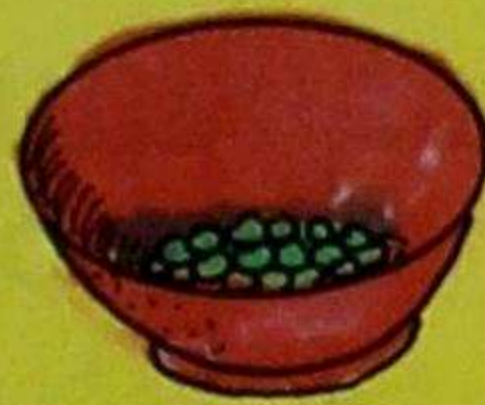

asha

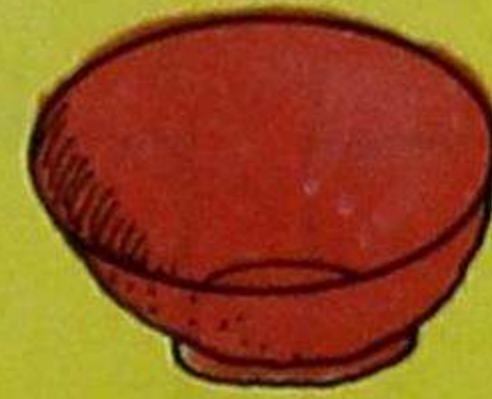

illac



chuya

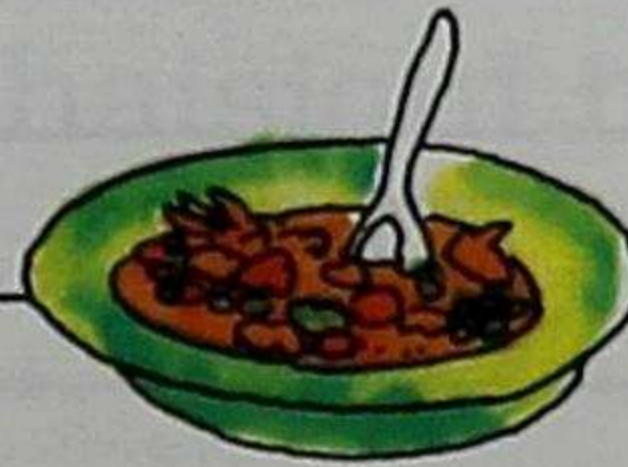

sancu

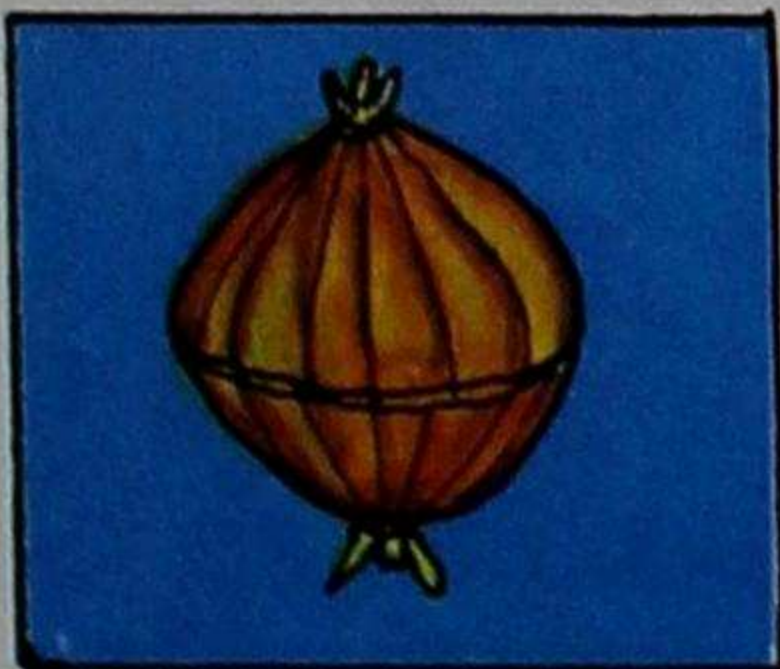

mishqui



cachi

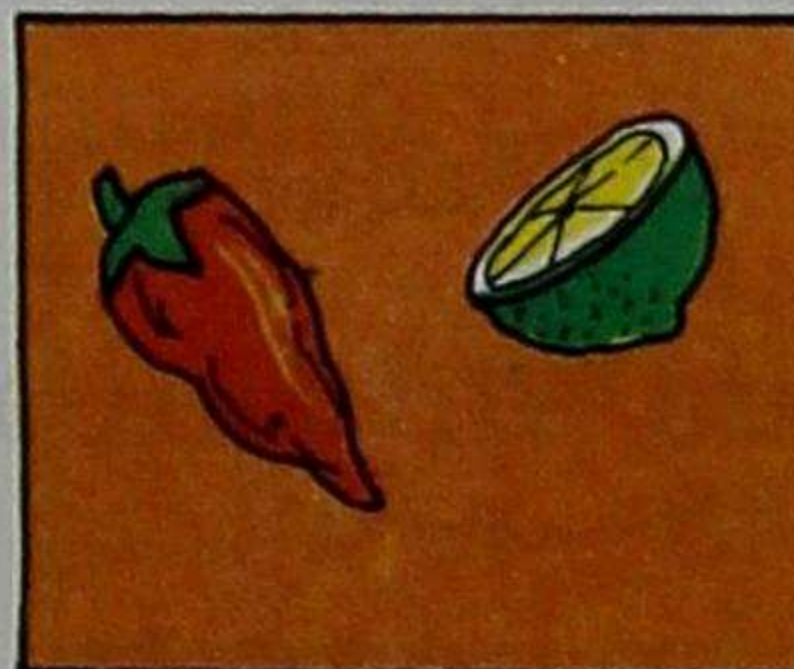

jayac

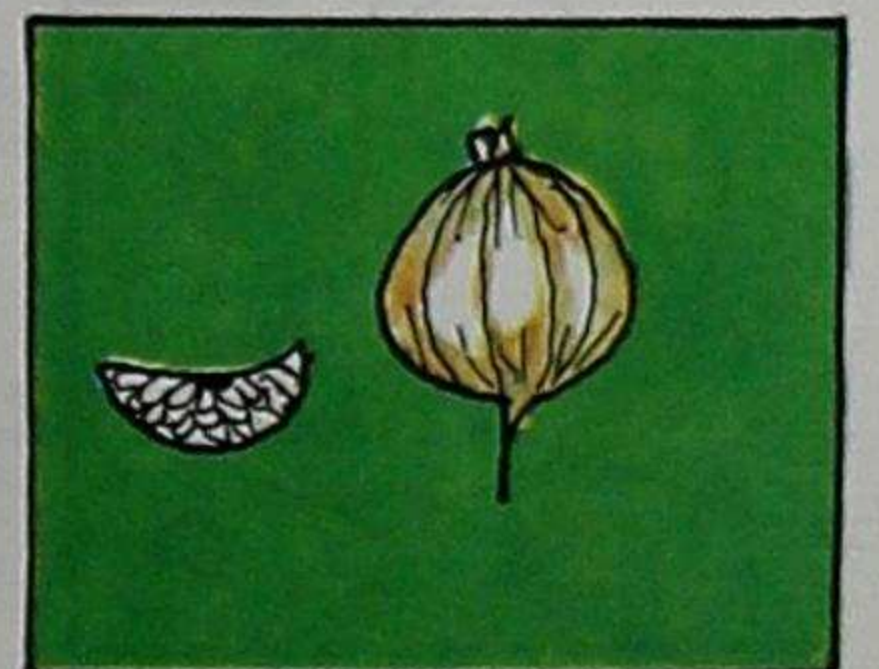

ashnac

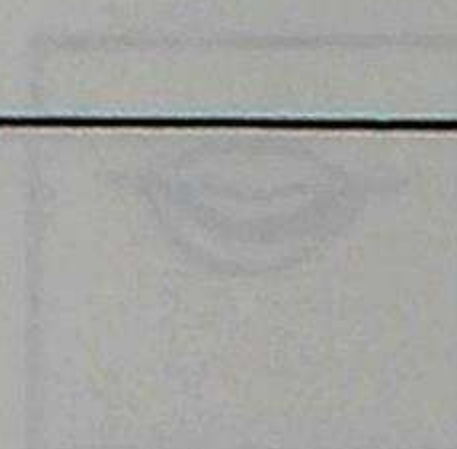
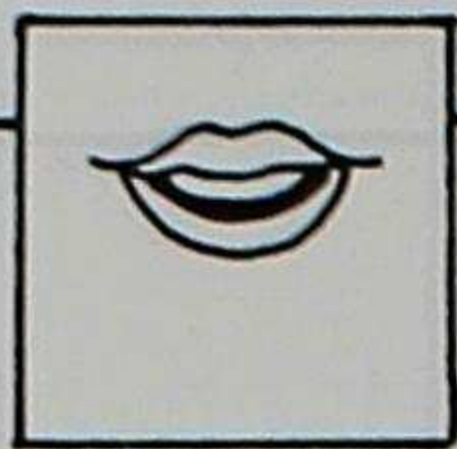

jatun



uchilla

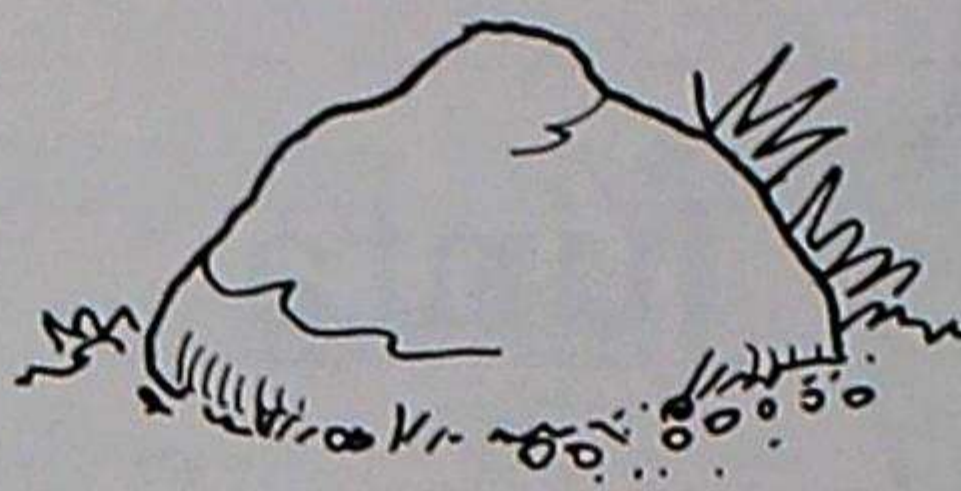

llashac

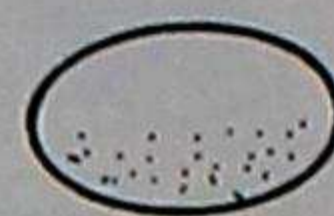

pancalla

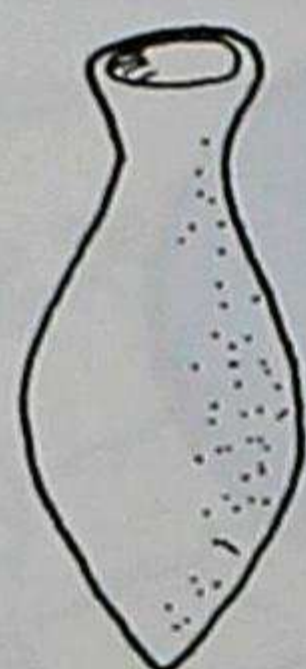

jatun



chuzu

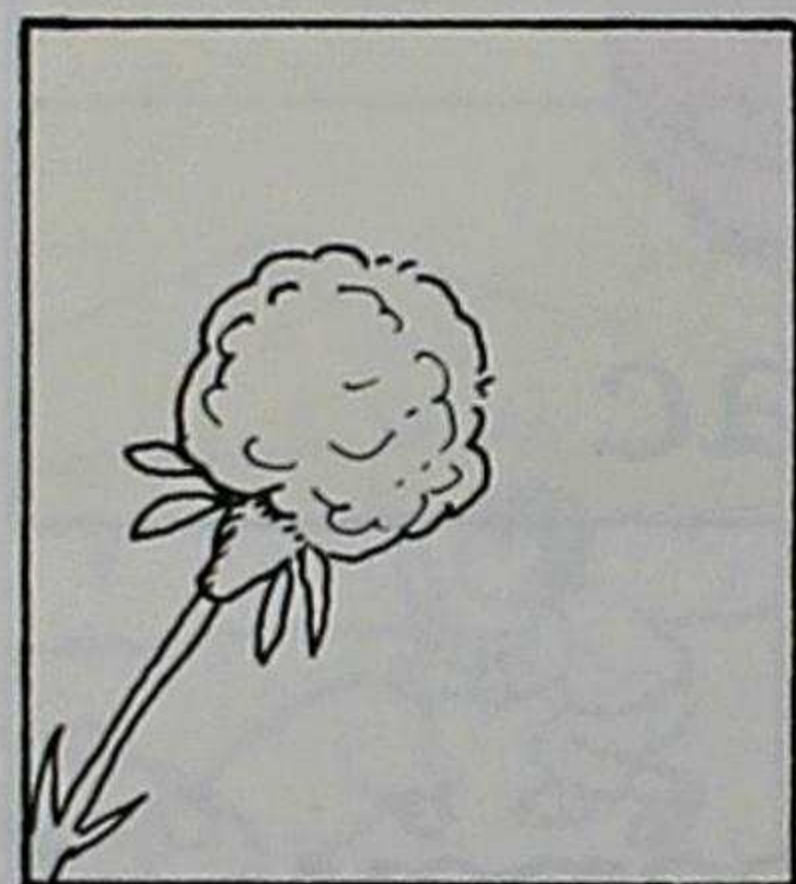
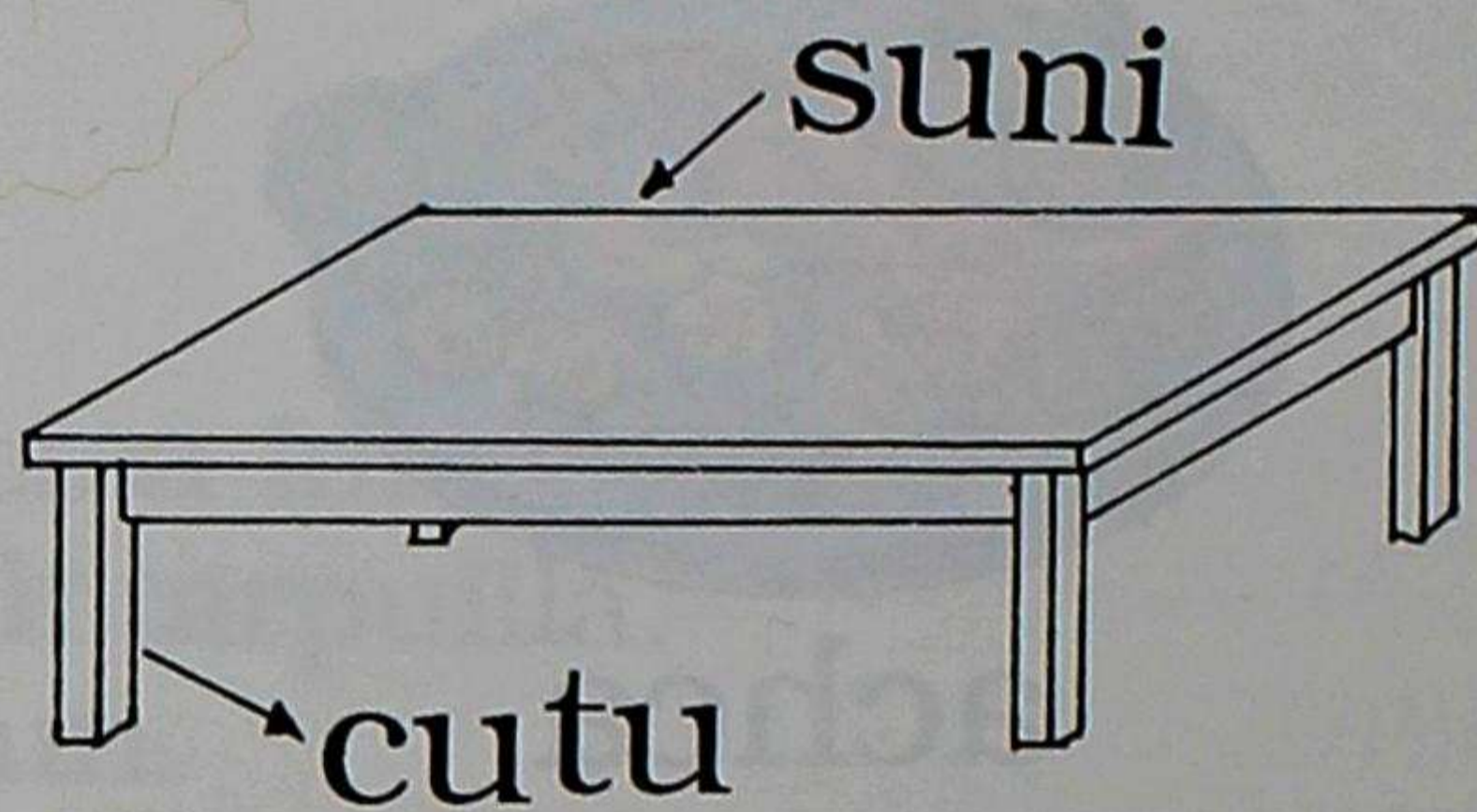

yurac

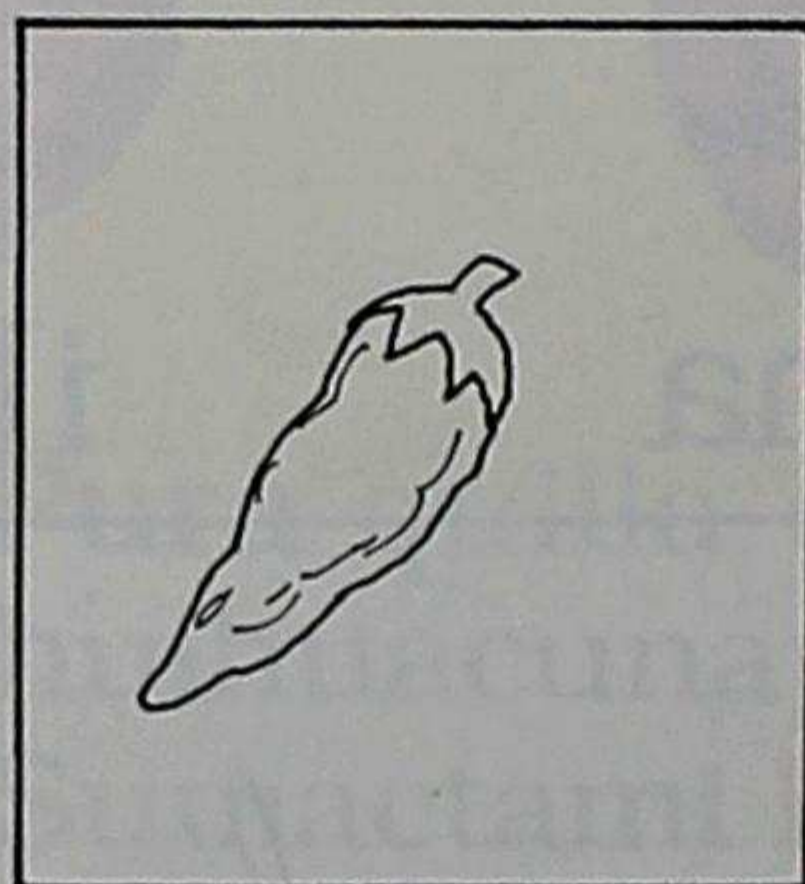

puca

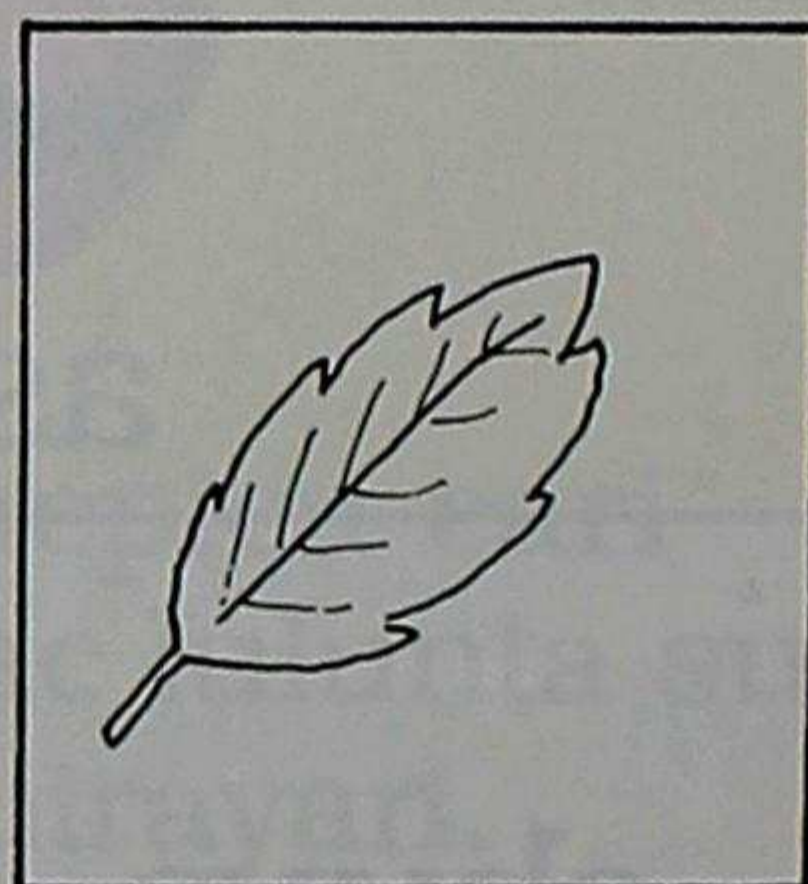

huaila

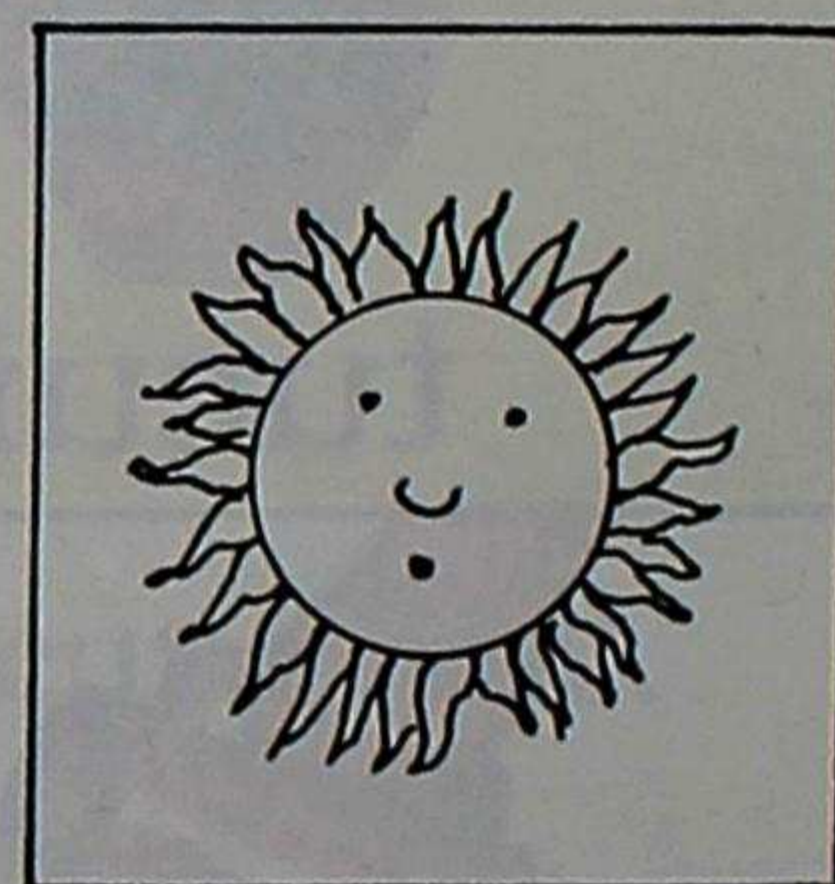

quillu

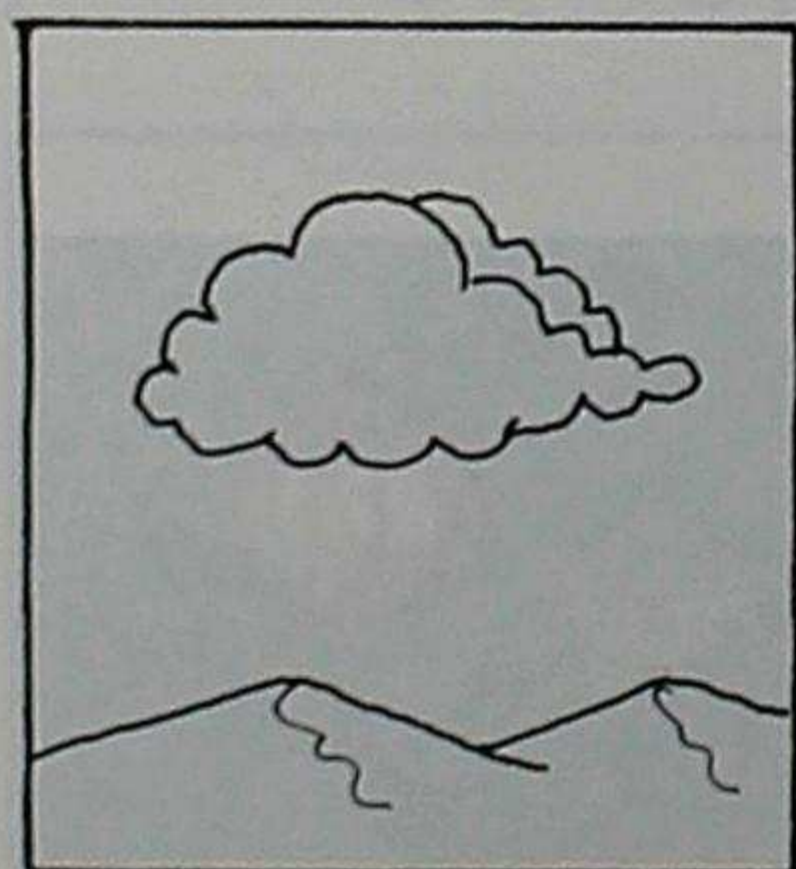

ancas

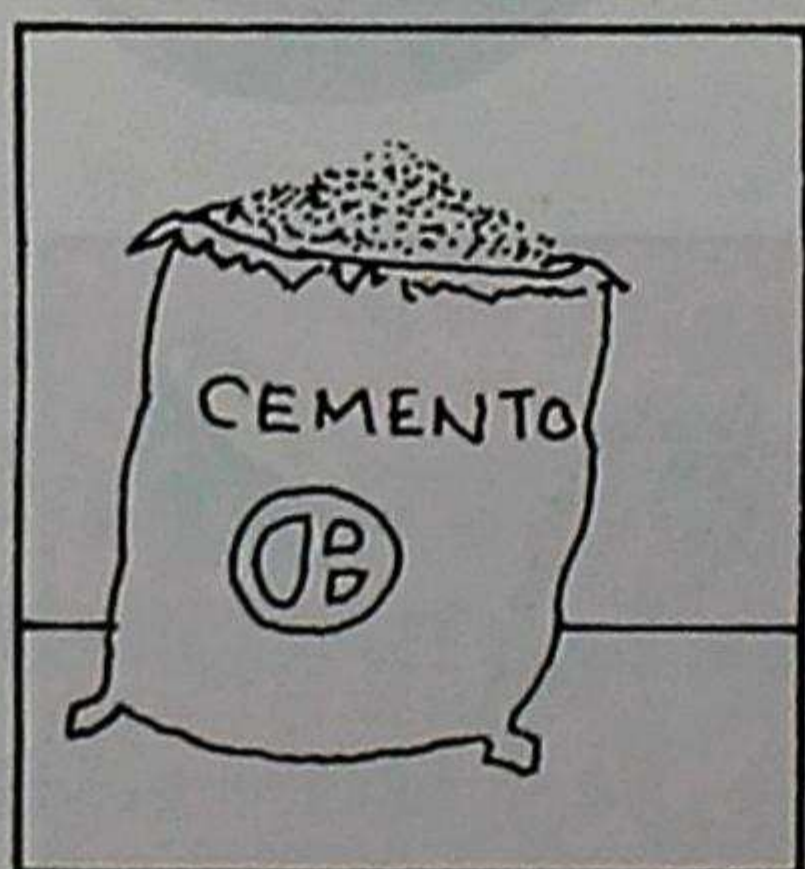

puzu

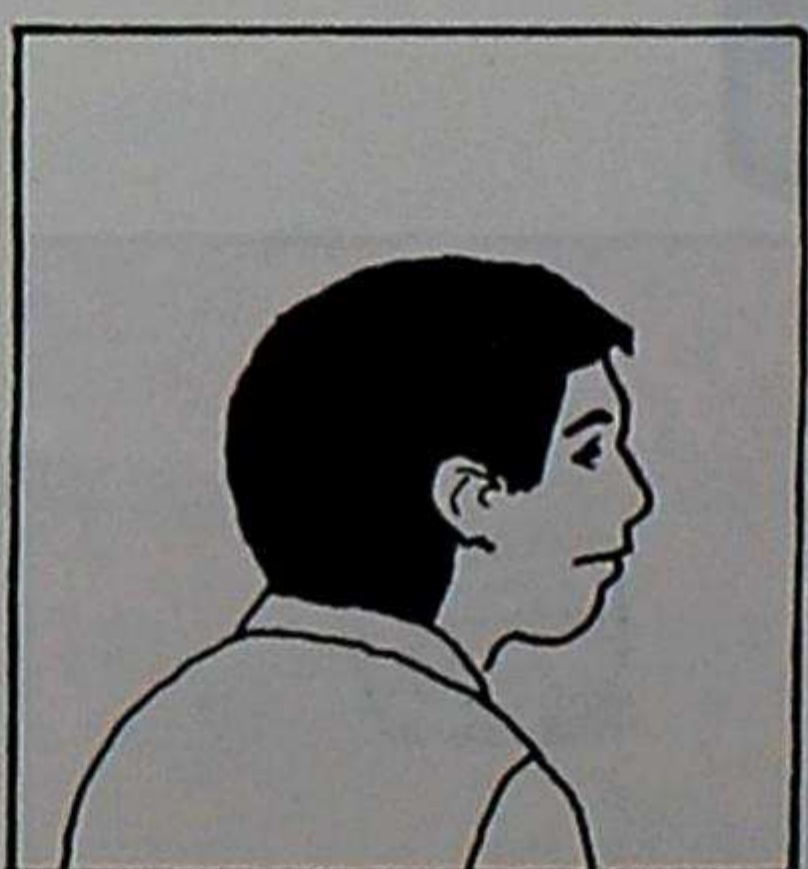

yana

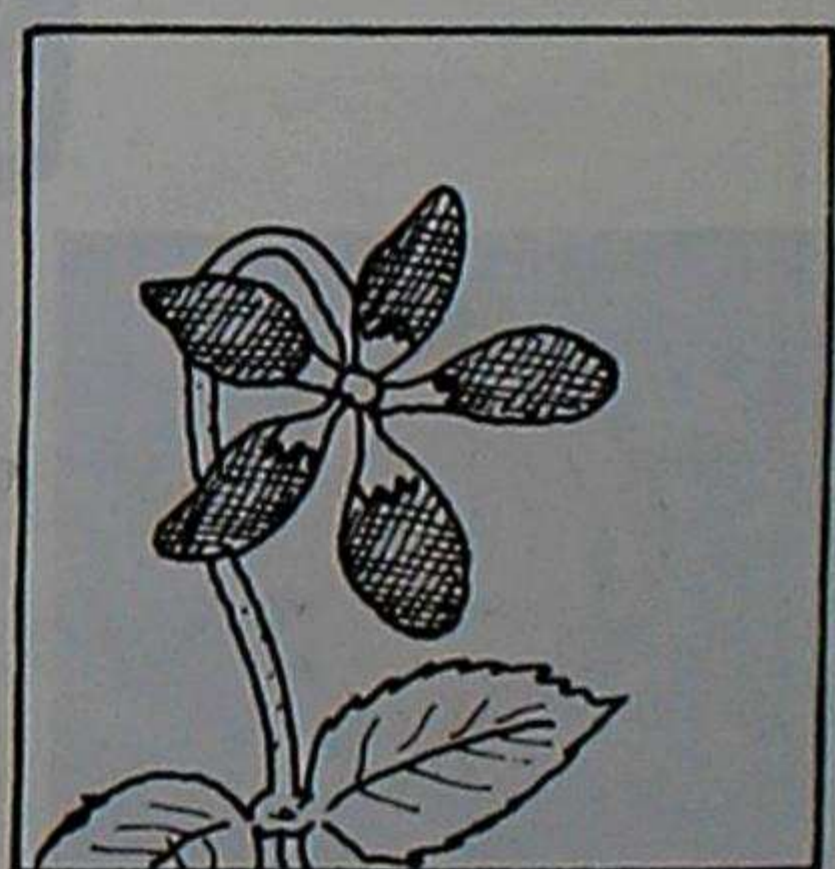

maihua

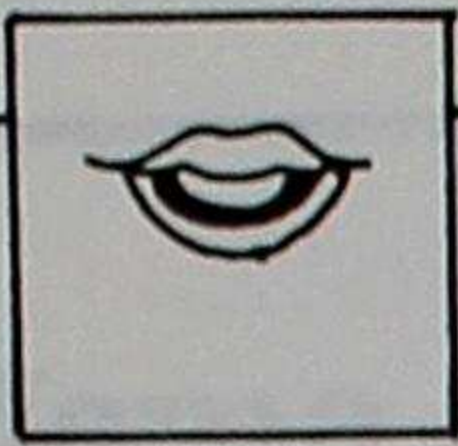

## Llactapac iñinacunamanta

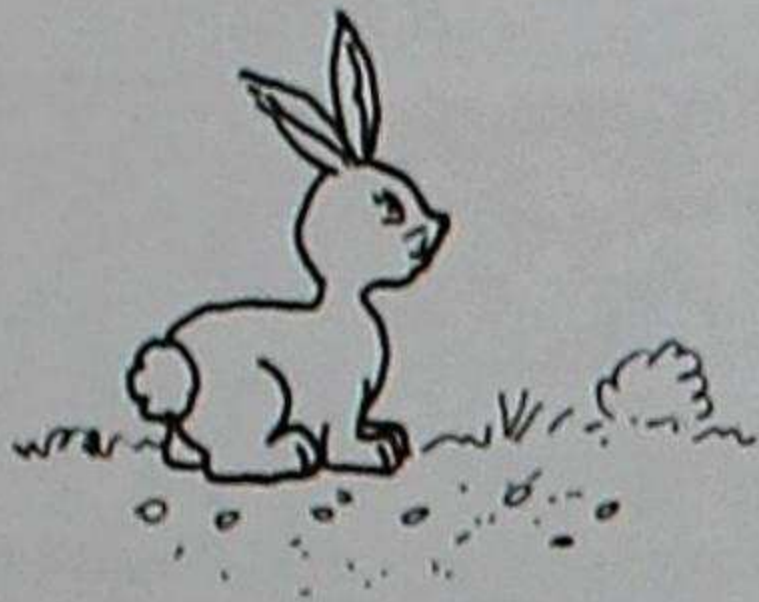

\* Huanpracunaca cunu umataca mana micunachu, ñapashmi yurac uma tucuncacuna.

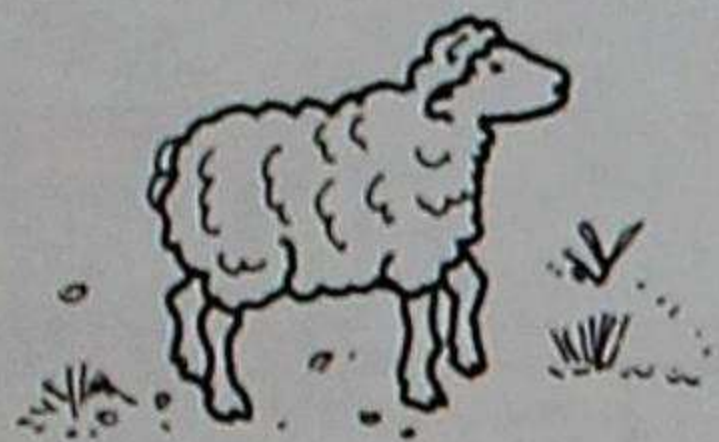

\* Huanpracunaca, llama tuncuritaca mana micunachu, huañucuc llamashinami jar, jar nishpa puñuncacuna.

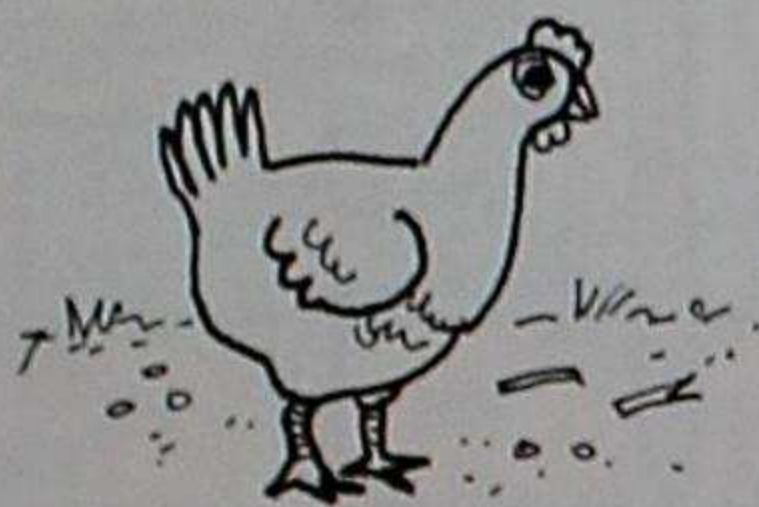

\* Mana atallpa chaquita micunachu, quillcancapacca atallpa shinami aspirin.

\* Atallpa umataca mana micunachu.

Tutayacpica alli ricuita mana usharinchu.



\* Huahuacunamanca, cui shuncutaca mana caranachu. Cui shinami manchaisiqui tucushpa huiñancacuna.

\* Cui maquicunataca mana micunachu. Cui shinami ima ruraitapash mana usharinca.

\* Mana cui cashtunata micunachu, cui shinami cashtunaca chucchun.

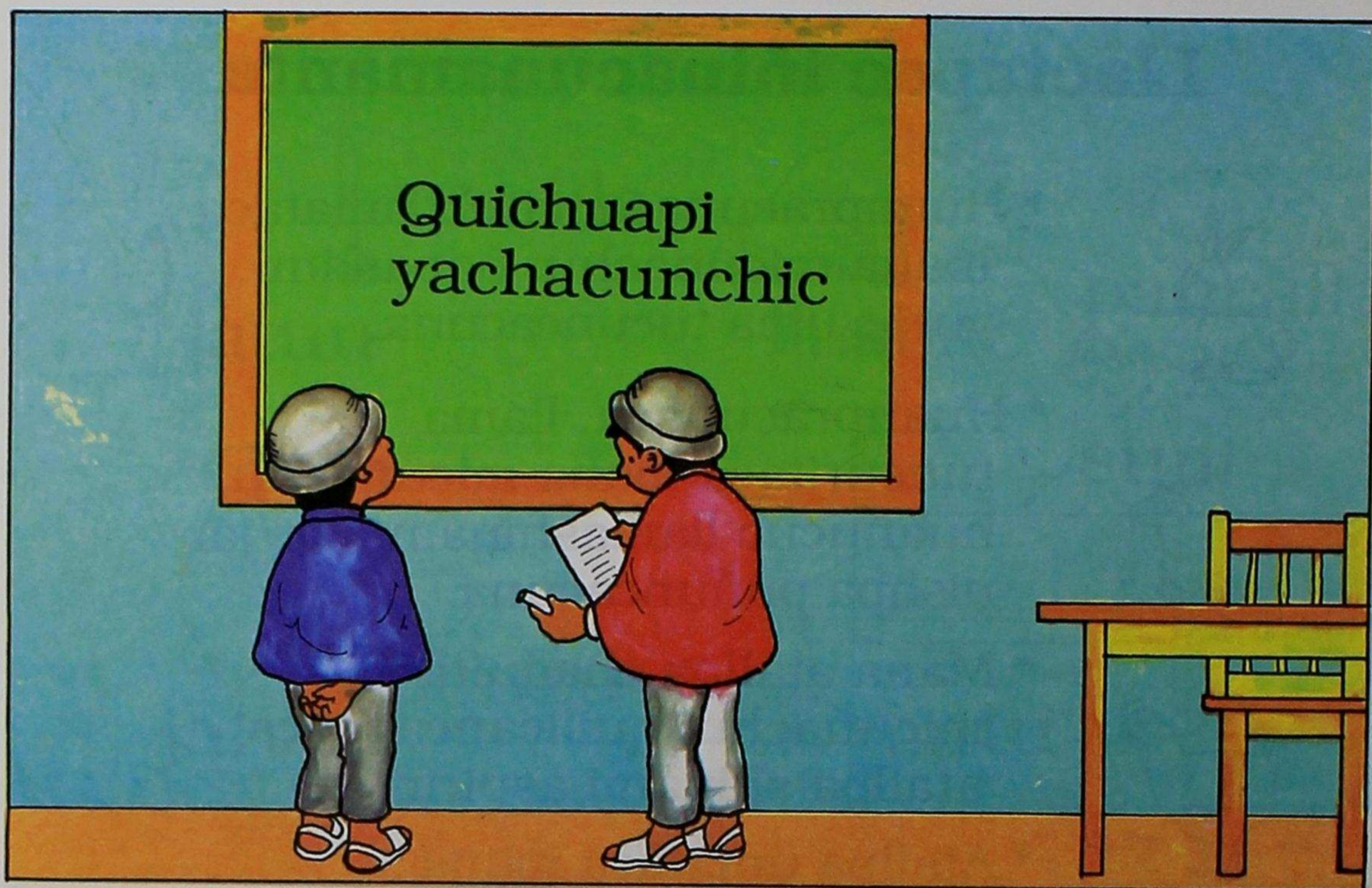
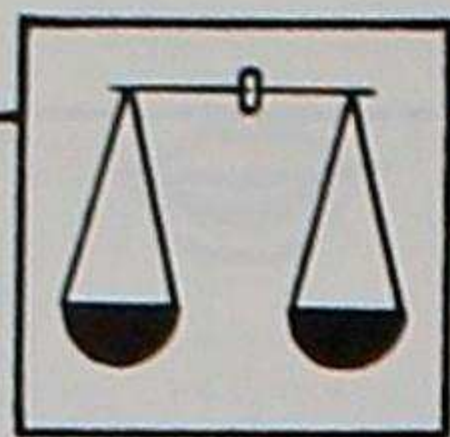

Ñucanchicca quiquin shimipi  
yachacunchic.

Yachana huasipica quichua shimita  
castellano shimitapash rimanchic.

Yachachicca ñucanchic causaita  
sinchiyachishpa ricuriashpapashmi  
yachachina can.

Jatun pushacpash ishcai shimipi  
yachanata sinchiyachishpa catichun  
munanchic.

# Mama allpapi tiyaccunamanta



Vicente Guamán Yupa

3. Patapac

Yachana huasi: Santiago Vásquez

Aillu llacta: Cahuana Panpa

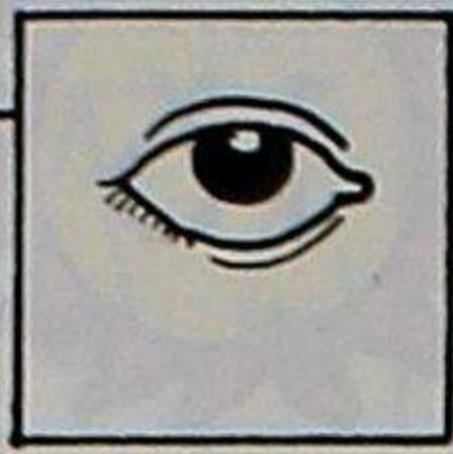

# Mama allpapi imashina raquirishcamanta

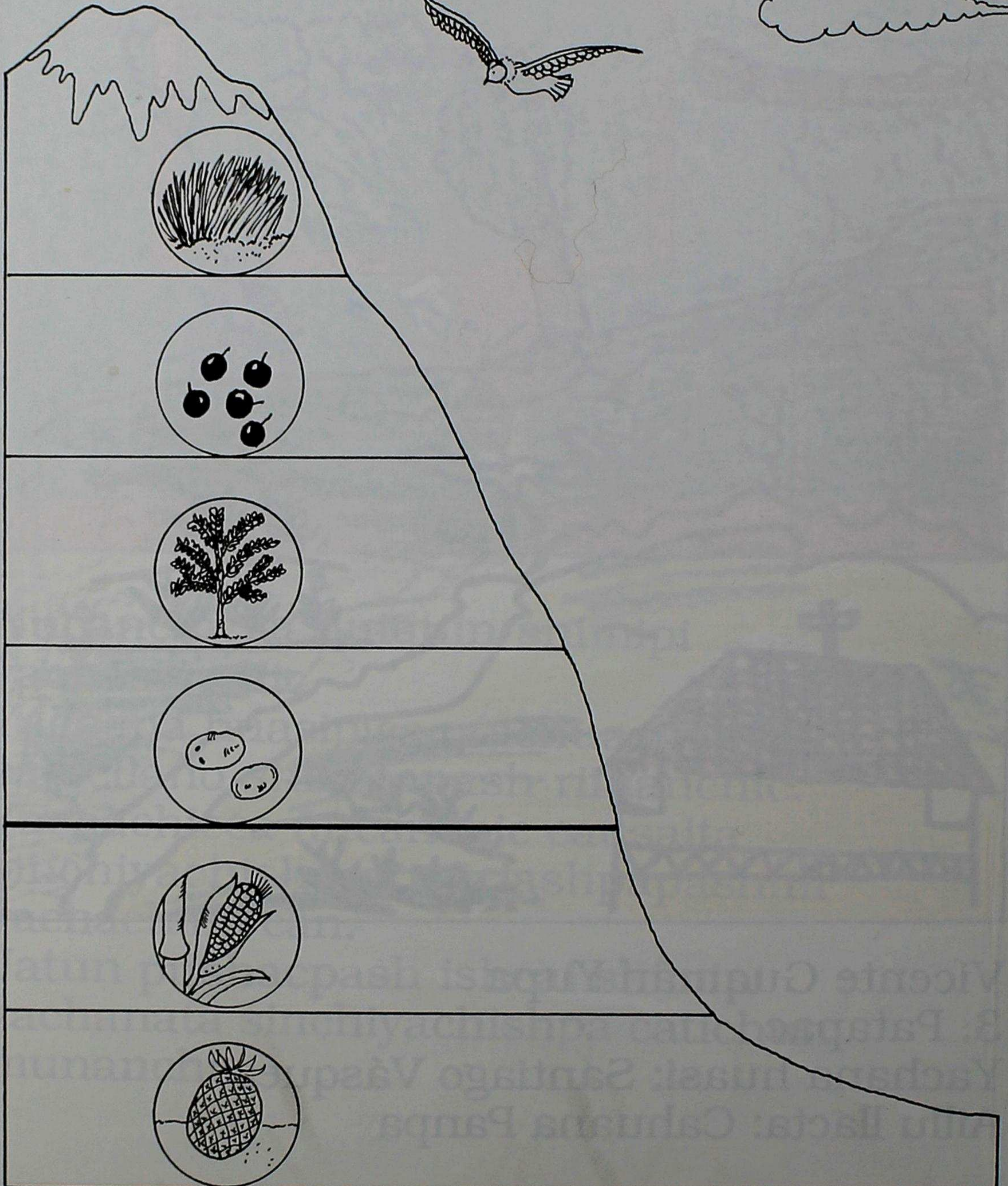
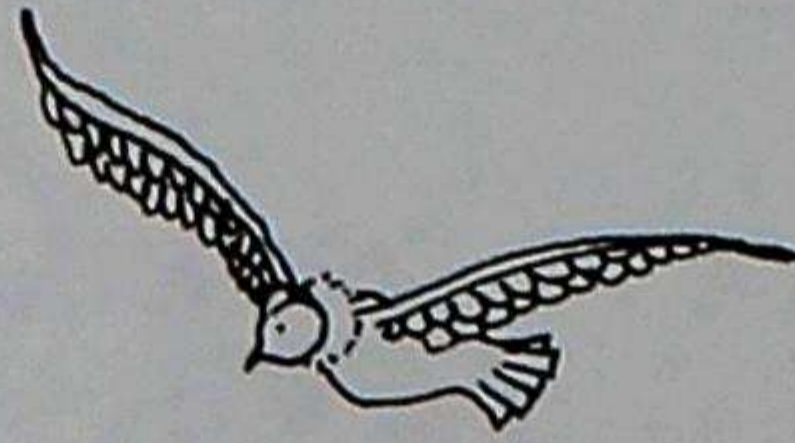
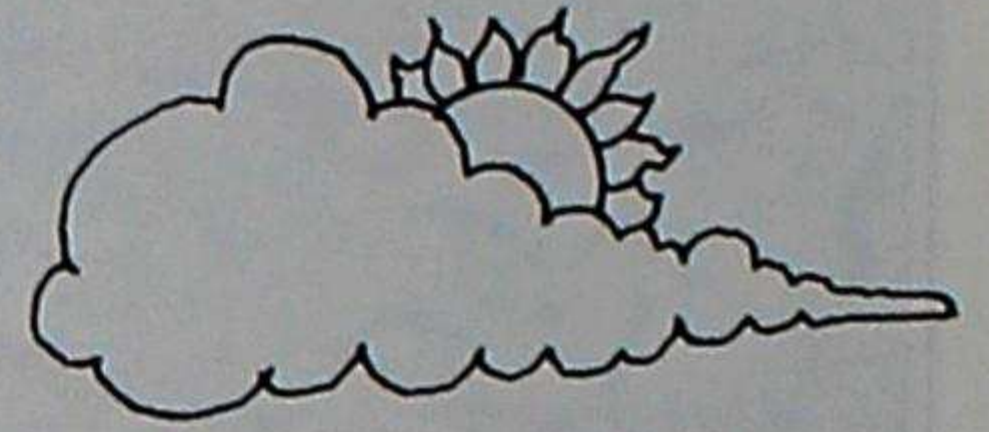

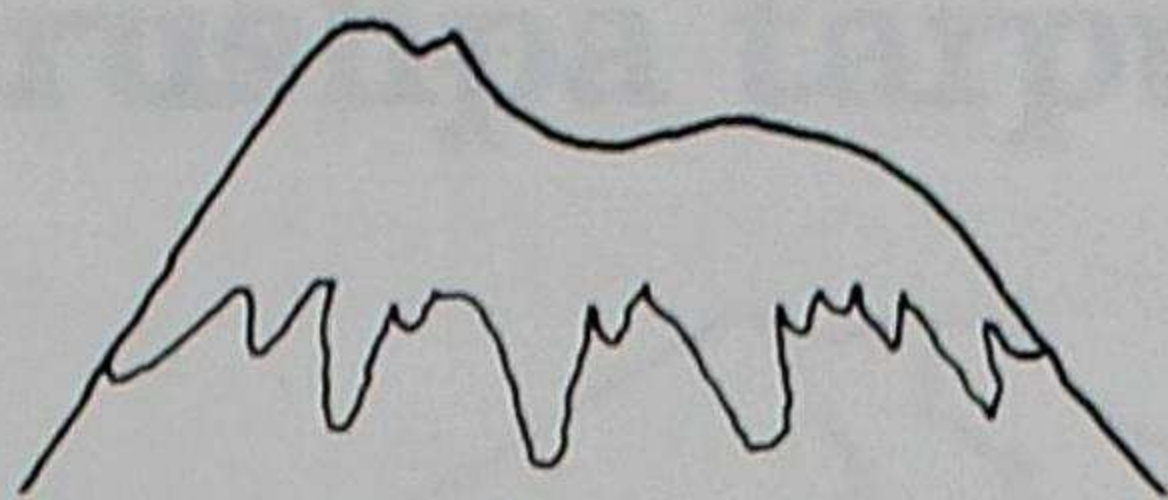
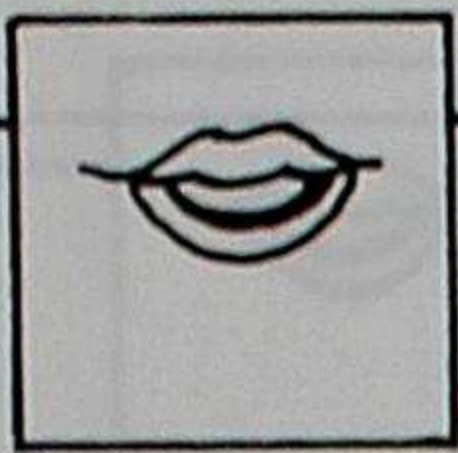

= Ucshaca jahua urcupimi huiñan.

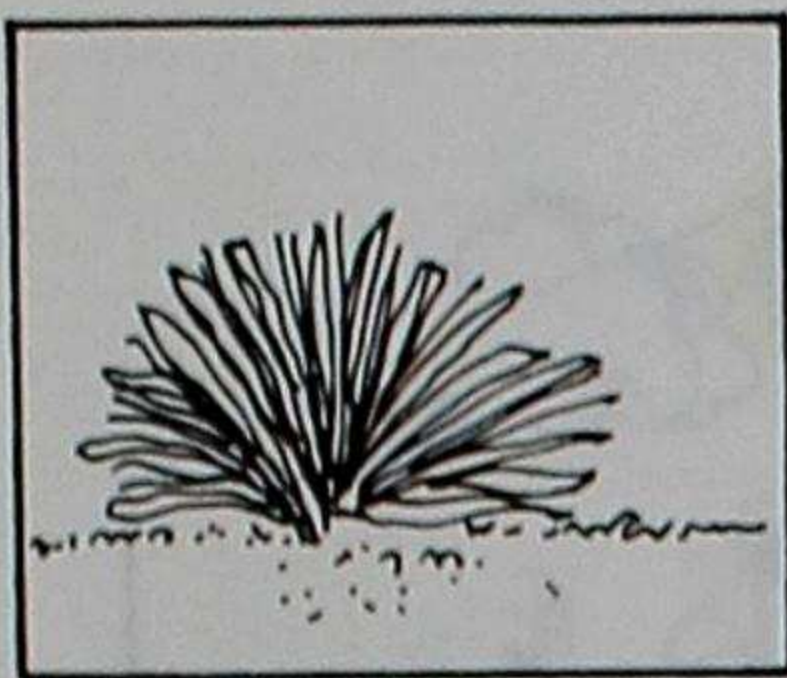

= Mortiño, motilón morapashmi jahuapi pucun.

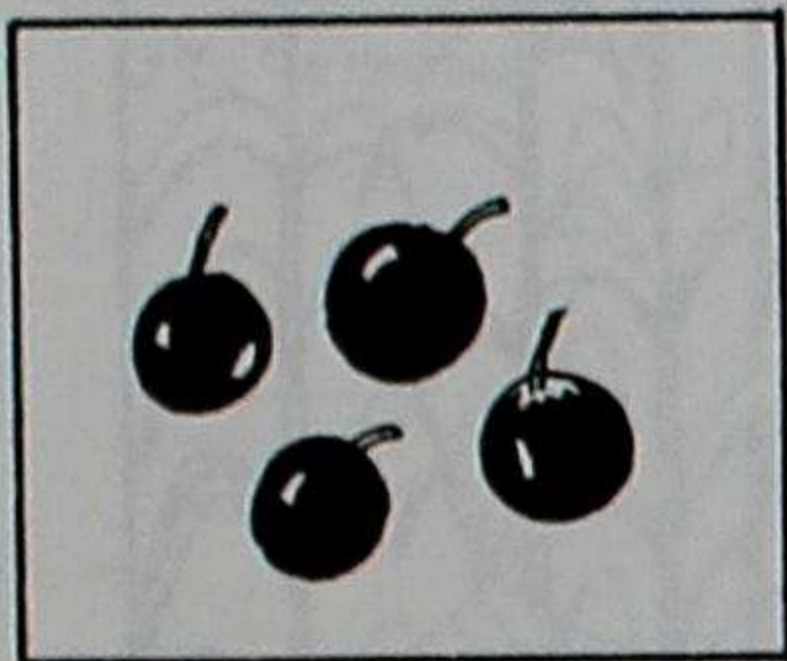

= Quishuhuar, puma maqui, tuctiyura jahua allpapi pucun.

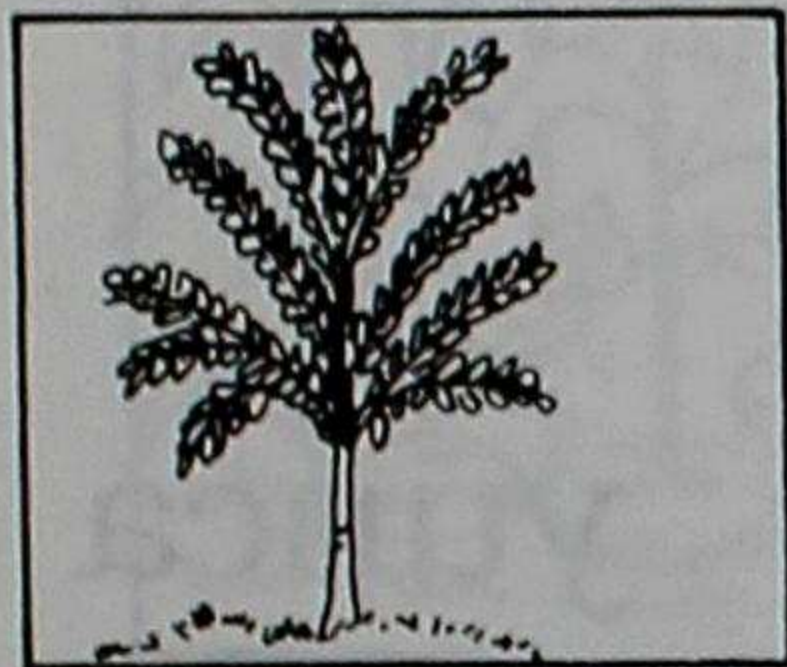

Papaca, ucaca, ullucuca,  
= taurica, quinuaca, trigoca  
cebadapash jahuallapi pucun.

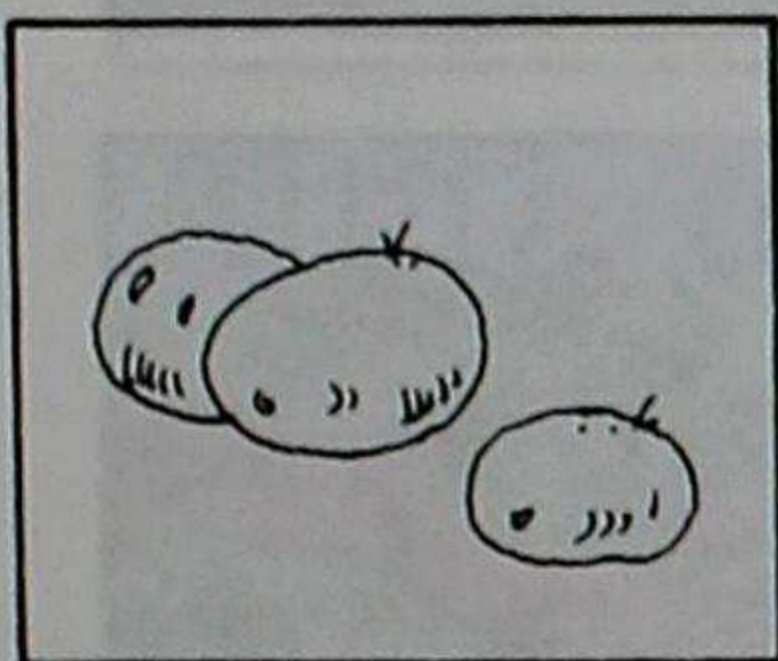

Urcu chaupipi saraca, purutuca,  
= zanpuca, alverjapashmi pucun.  
Chirimuyapashmi huiñan.

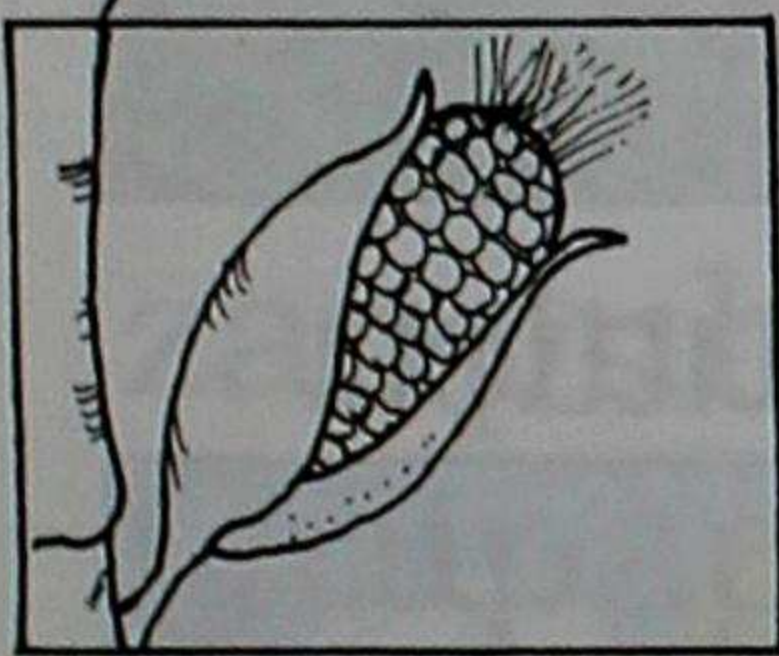

= Chihuilla, palanta, lumu, huiru,  
naranjapashmi yuncapi pucun.

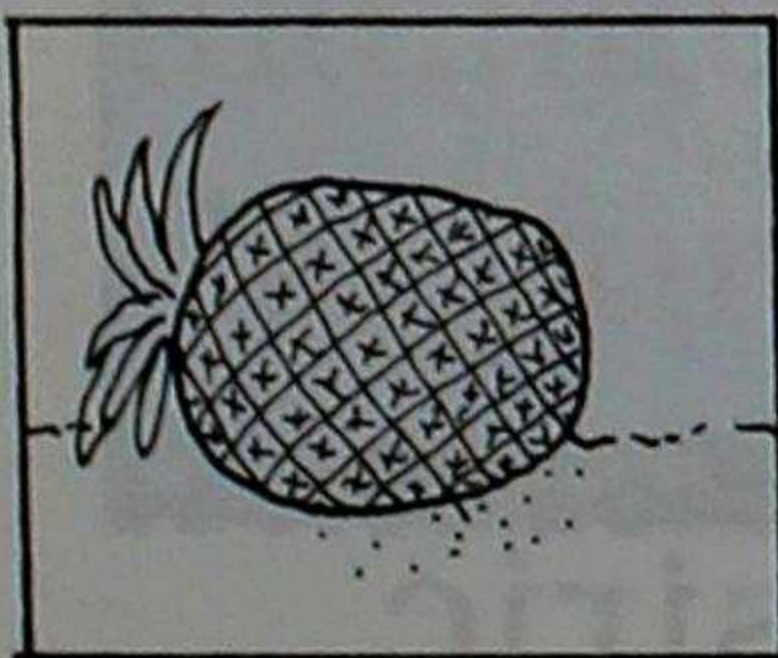



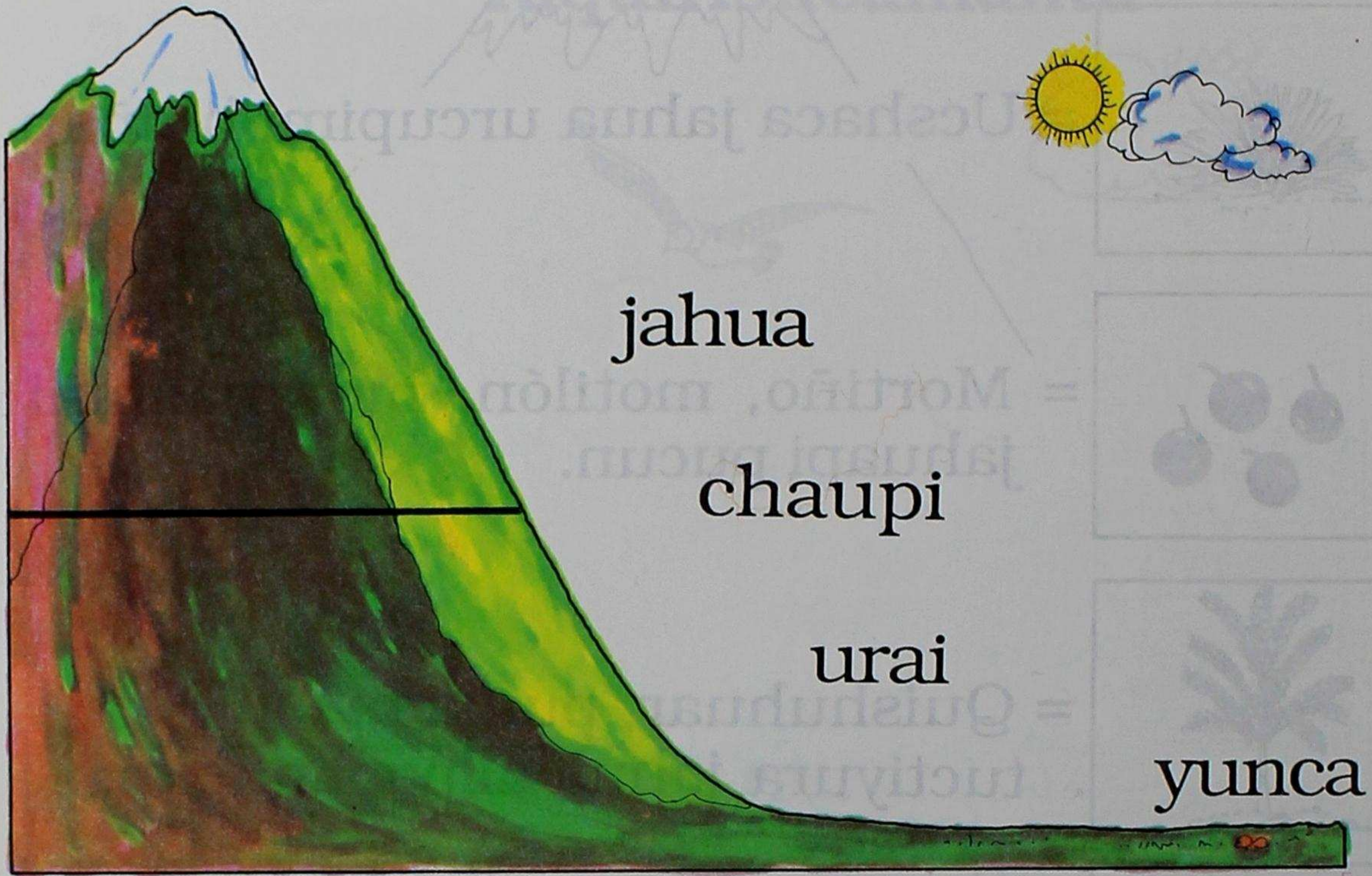
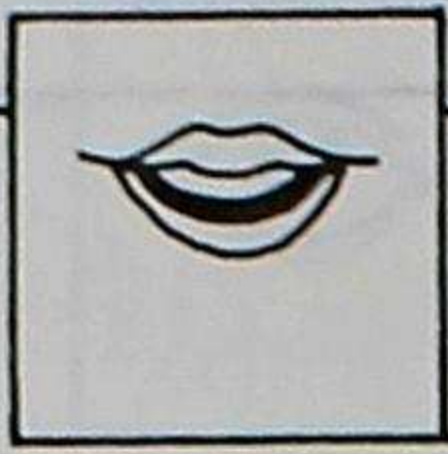

jahua

chaupi

urai

yunca

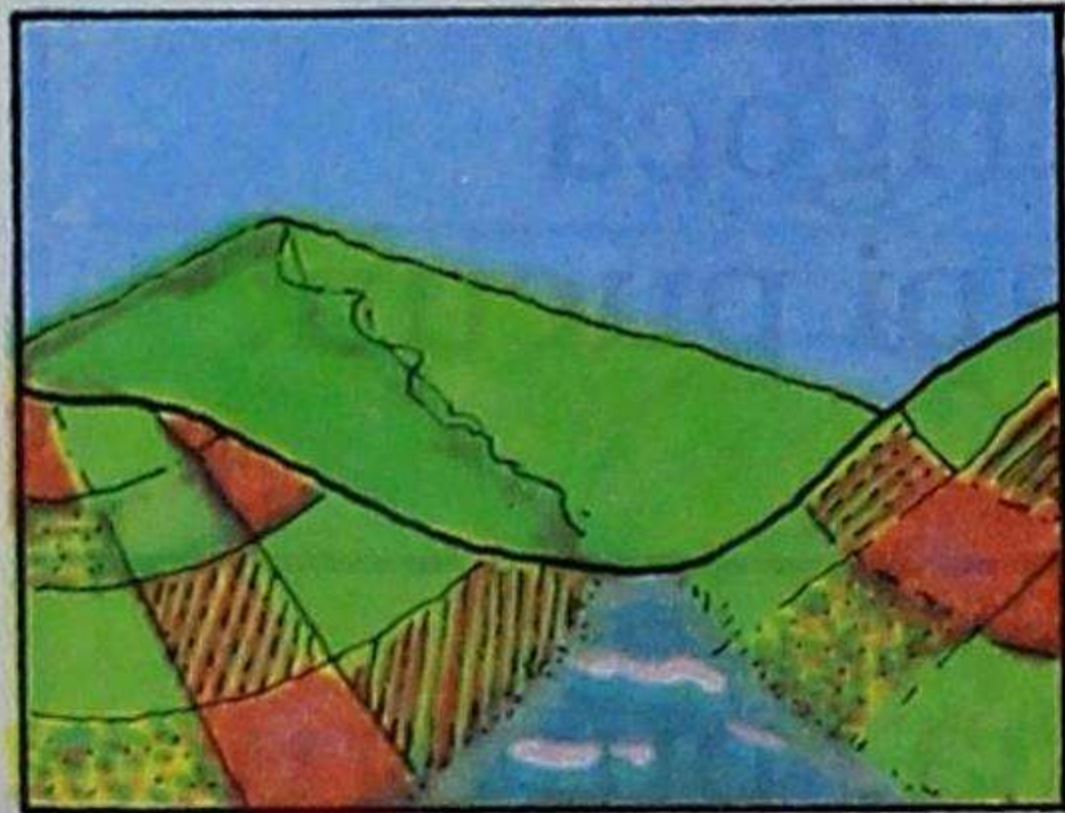

pucru

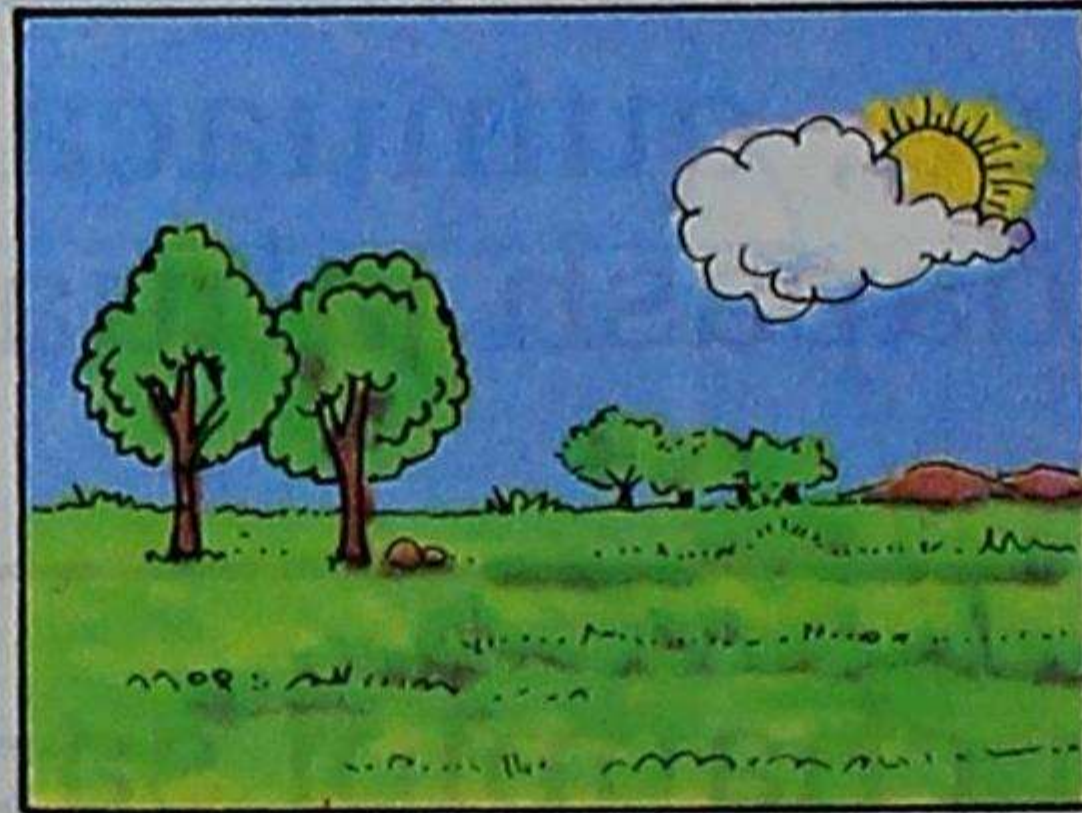

panpa

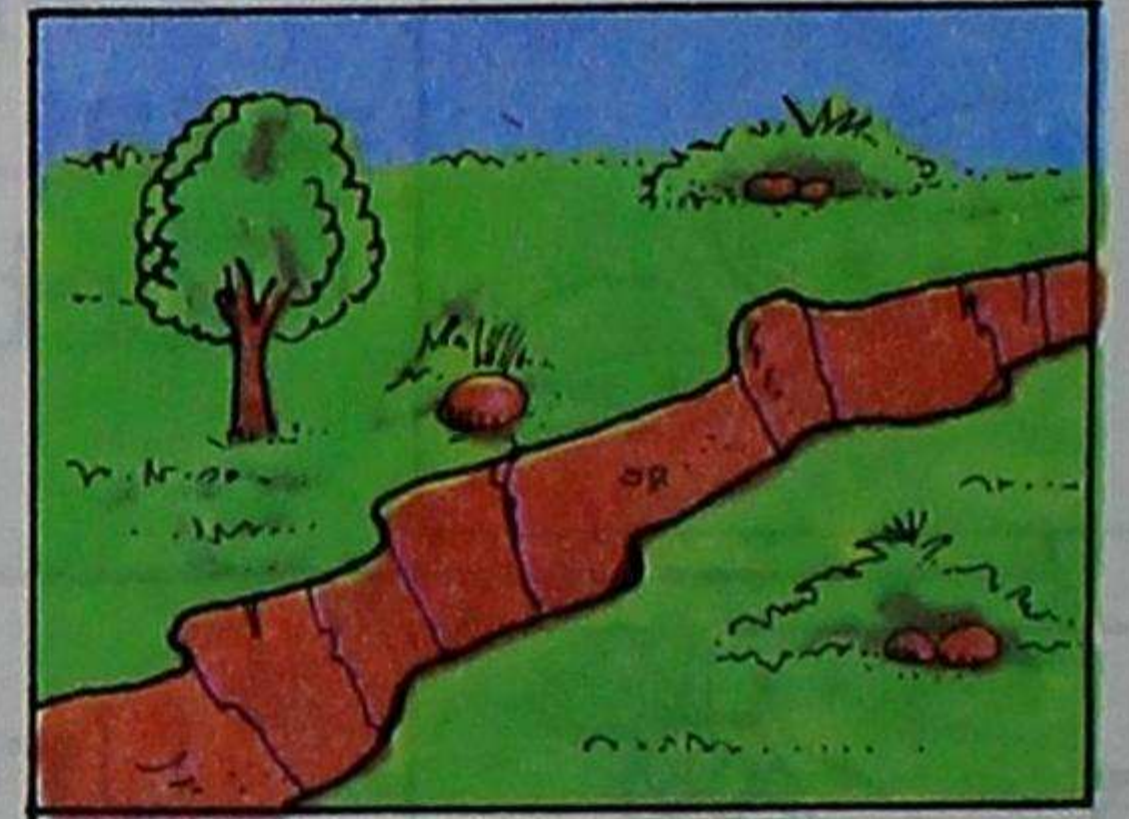

huaicu

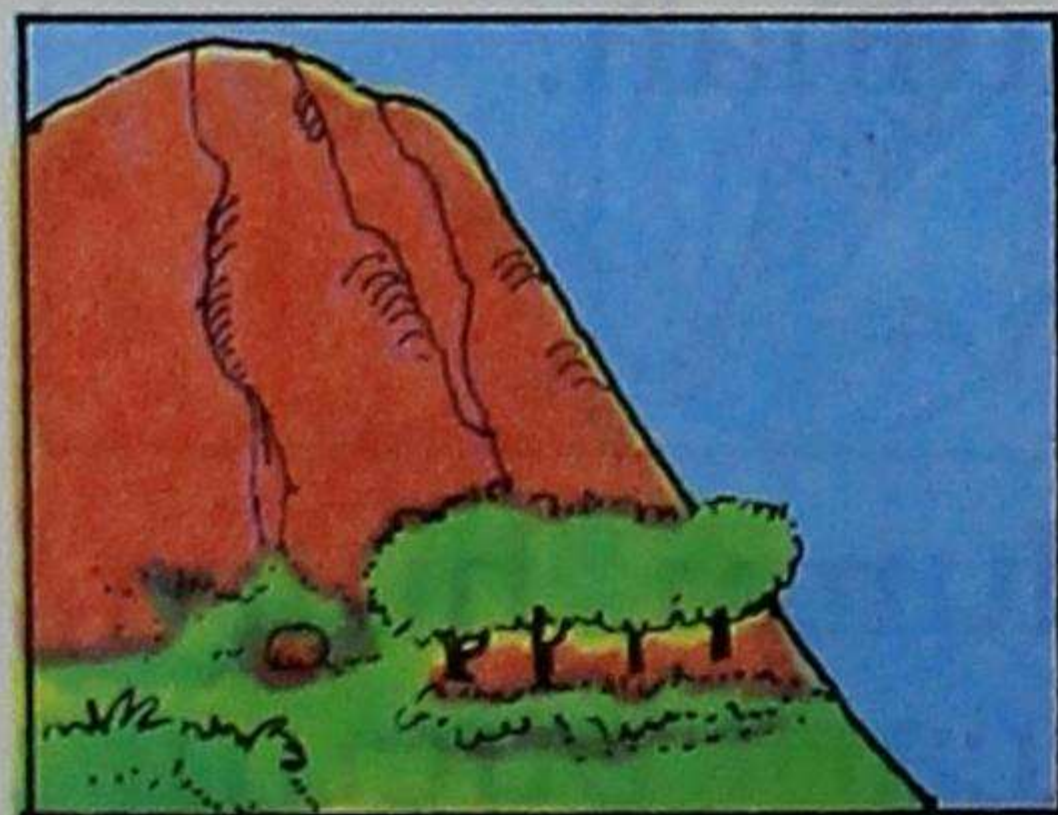

shayac



quincrai

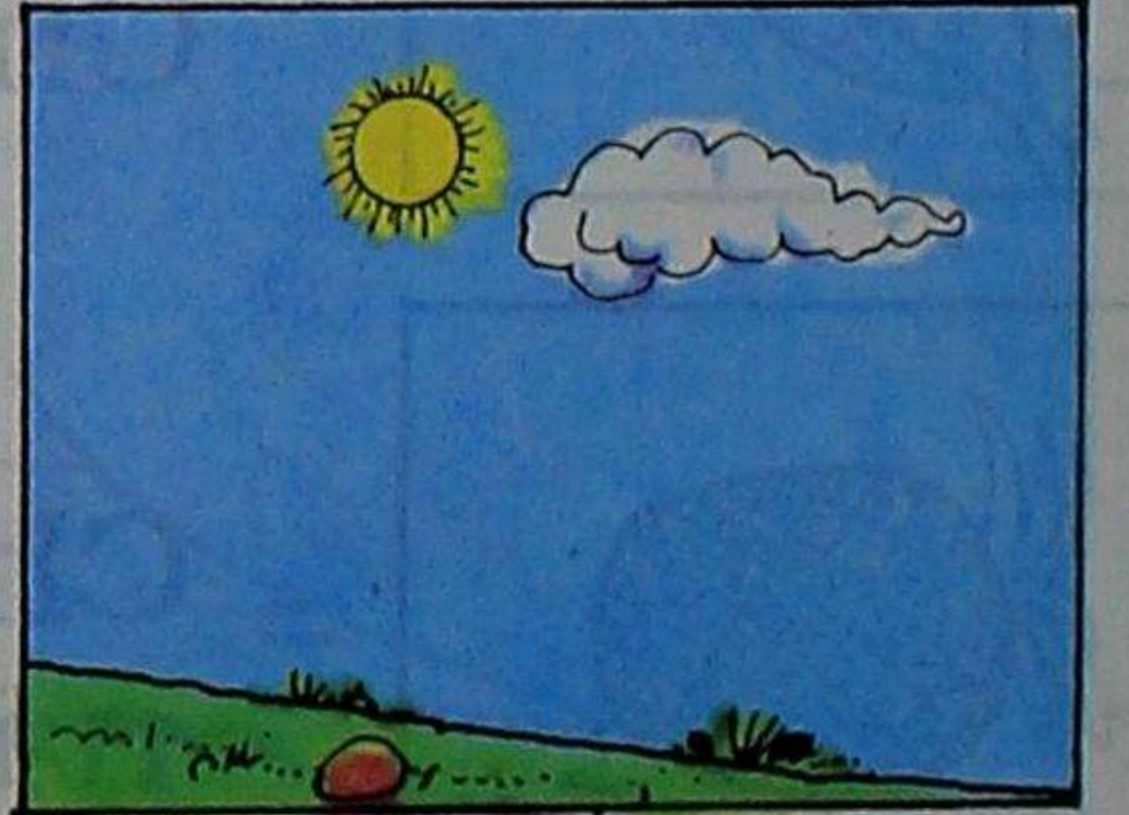

siric



# Chacrushpa tarpunamanta



Allita tarpuccunaca tauca  
muruhan chacrushpami  
tarpuccuna carca.

Shinami: sarata, purutuhan  
zanpuhanpash tarpushca.

Quipaca taurita, alverjata  
alfafatapashmi tarpuna canchic.

Cai yuracunami alpataca  
huanushpa saquin.

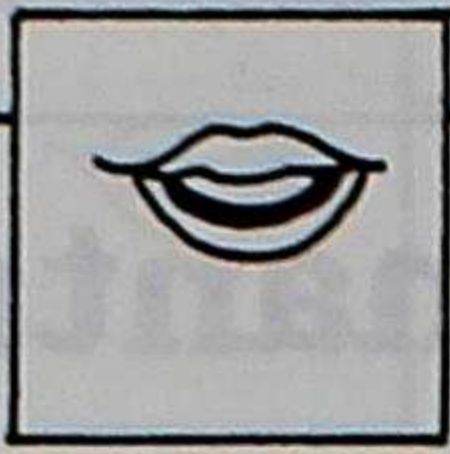

# Huanucunamanta

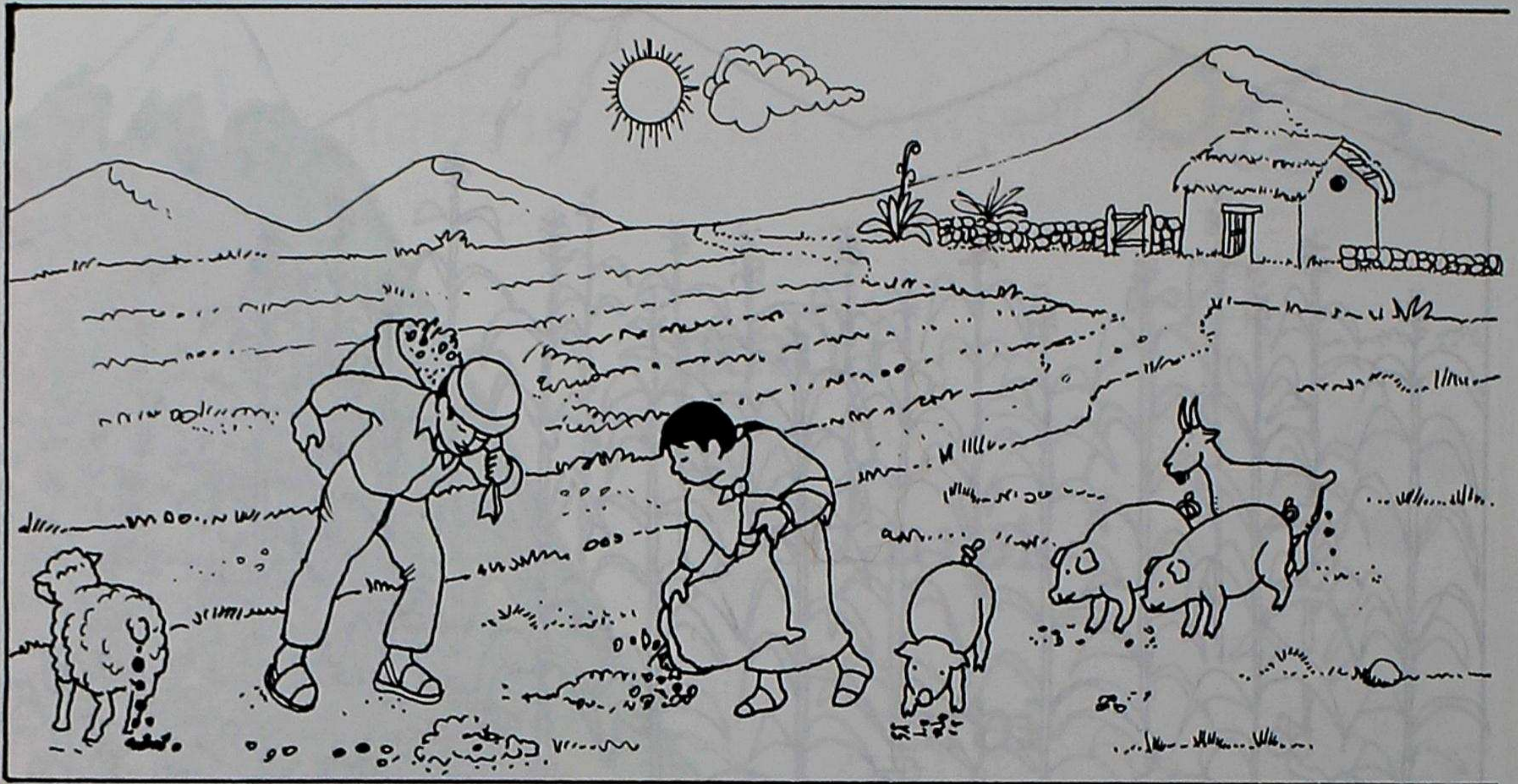

Ñucanchic allpacuna alli  
pucuchichunca huanutami churana  
canchic.

Shinapash tucui huanucunaca mana  
allichu can.

Ñucanchic huihuacunapac,  
yuracunapac ismushca huanucunallami  
alli can.

Cunan pachapica abono químico  
nishcacunami tiyan.

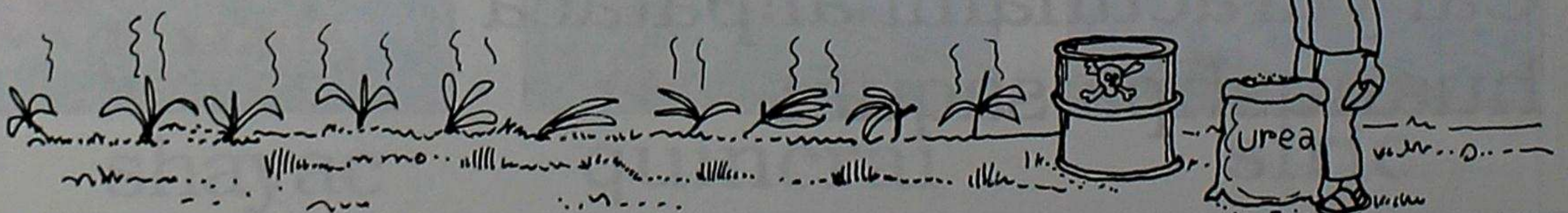

Caicunaca murucunapacca mana  
allichu can, uncuchinllami.

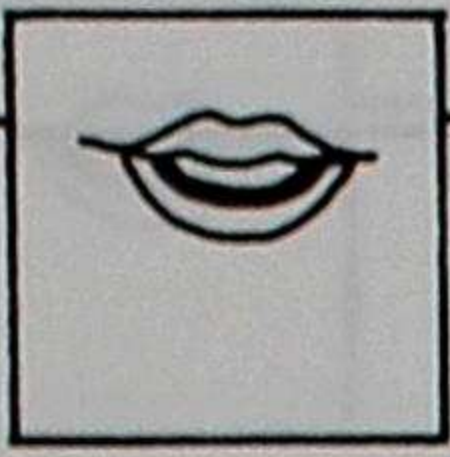

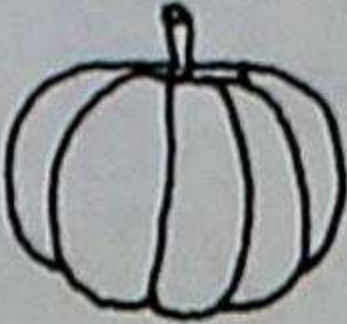

# Unanchacancha quillcana yachancapac

Cai  chaupi urcupi chacrata charin

Chaipimi  :   ,   , 

tarpushca

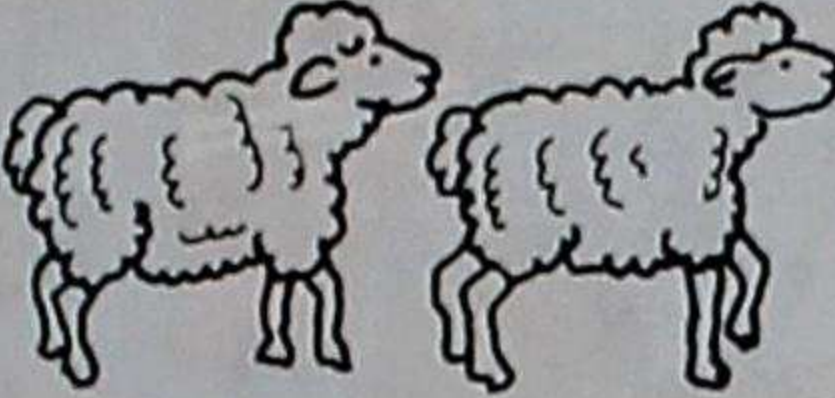
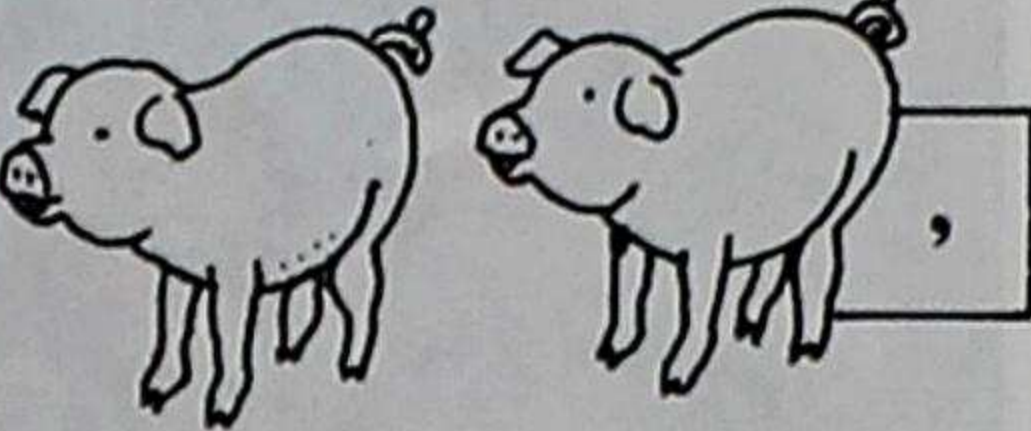
Chai runaca  :   , 

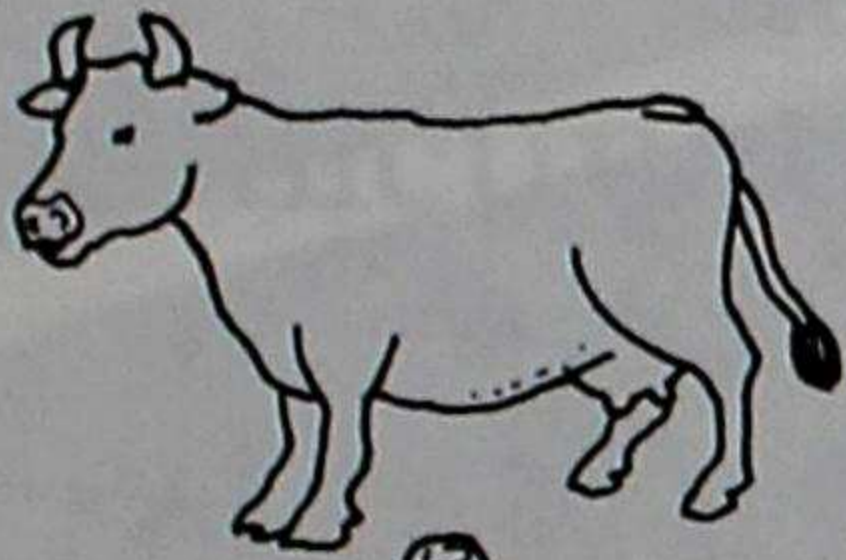

huanutami chacrapa shitan



Albertoca yuncaman rishpaca

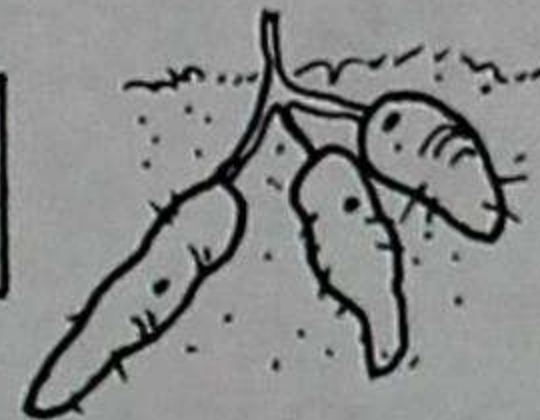
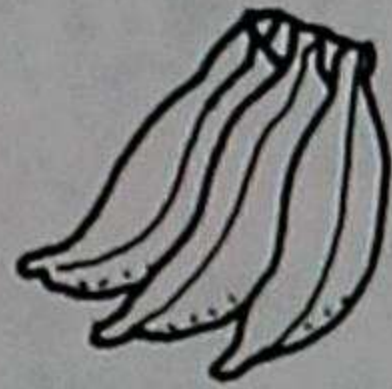

tarpushca

Cai murucunataca

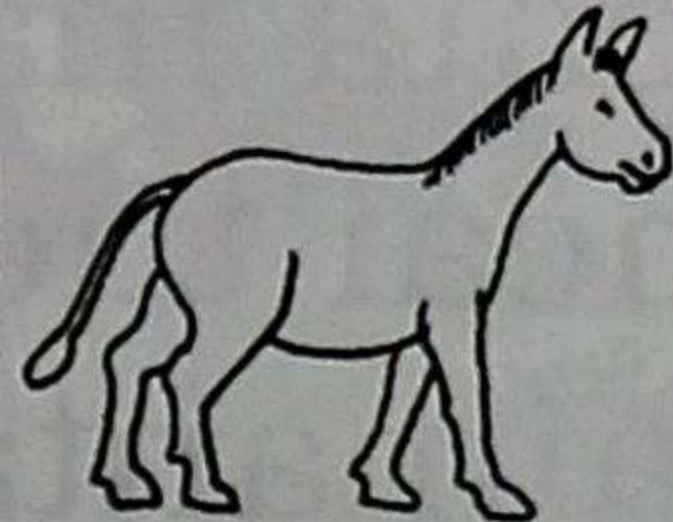

apamushpami catushca

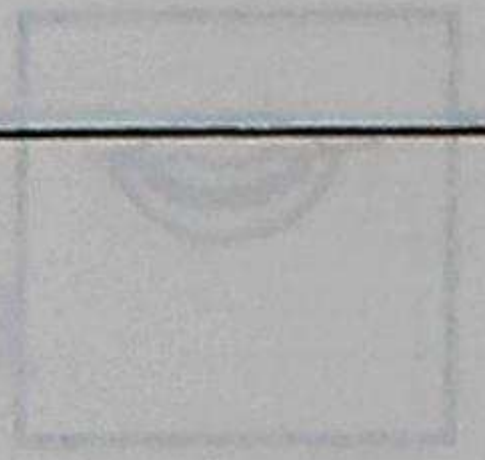
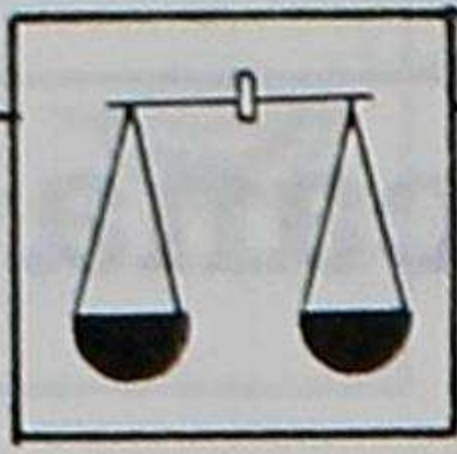

## Llactata saquinamanta

Allpata mana charishpami, mana  
llancai tucunchic.

Chaimantami jatun llactaman  
llancanapac rinchic.

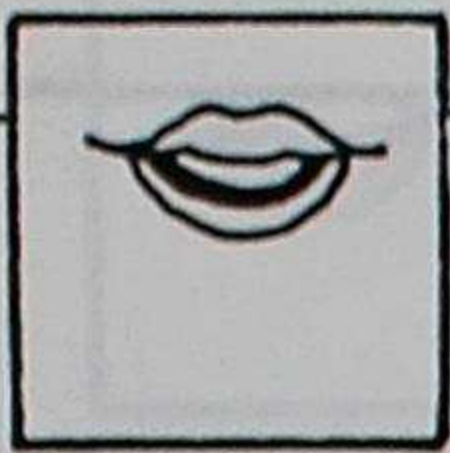

## Ñaupá raimimanta

Nucanchic ñaupá aillucunaca sumac  
raimicunata charic cashca.

Cai raimicunapica tucui runacuna  
tantanacushpami taquishpa tushuccuna  
cashca.

Chai punchapica alli micunatami  
micuccuna cashca. Upiancapacca sara,  
quinua asuatapashmi ruraccuna cashca.  
Cunanca San Juan, San Pablo, San Pedro,  
Corpus, Carnaval shutihuanmi ñucanchic  
raimicunaca saquirishca.



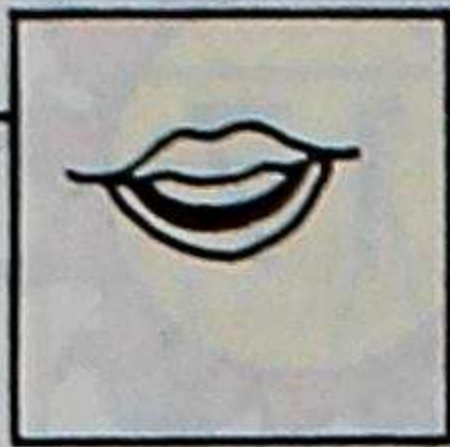

# Taquinamanta

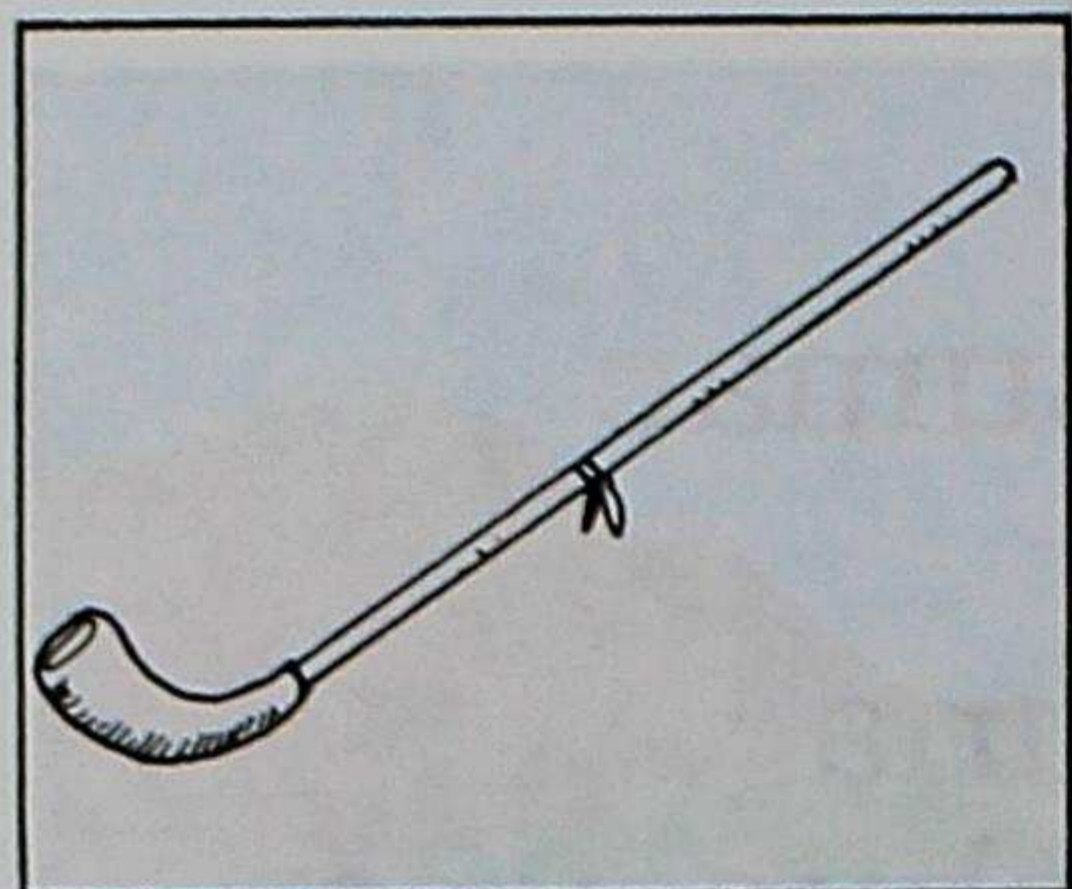

quipa

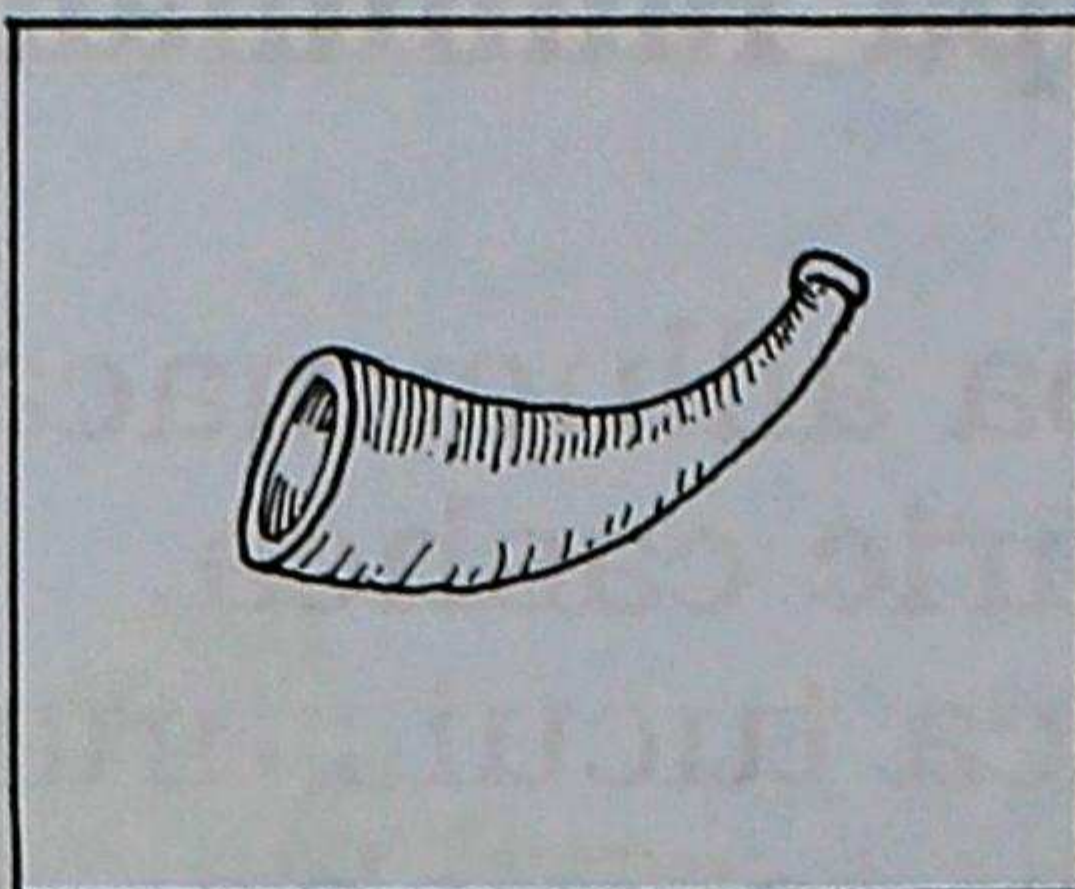

cachu

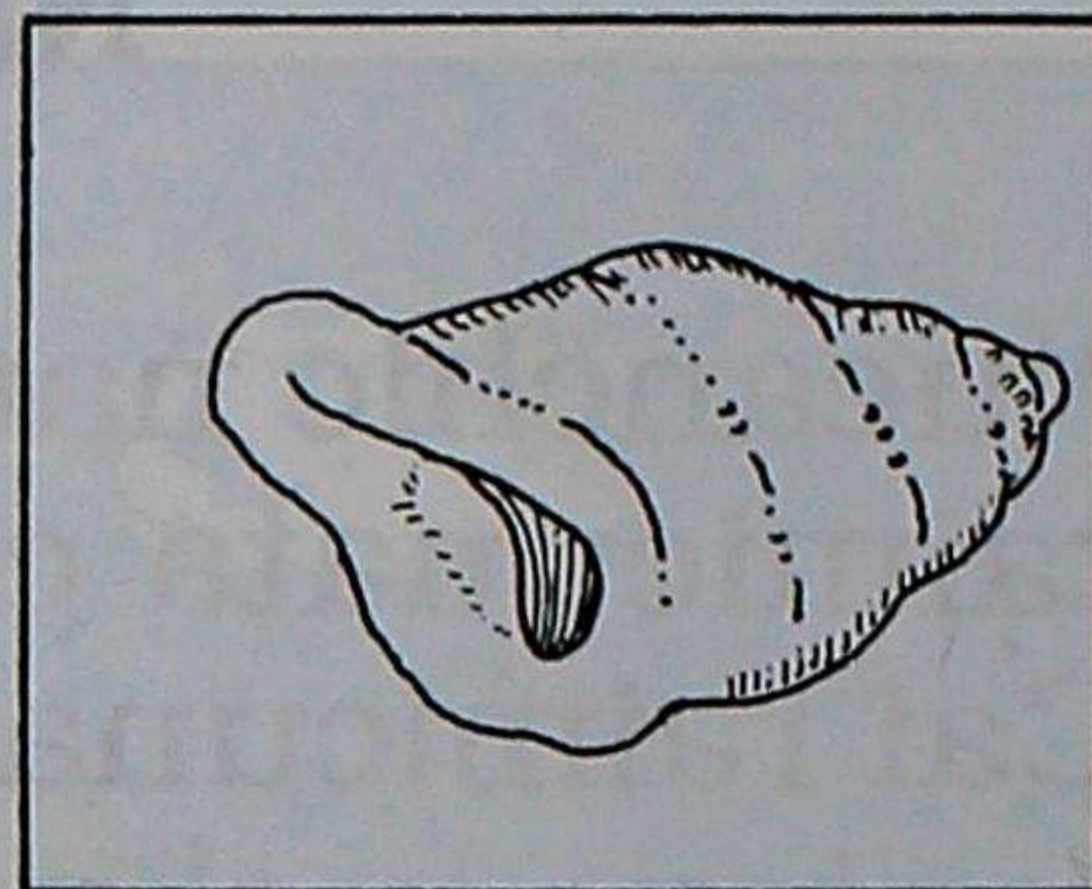

churu

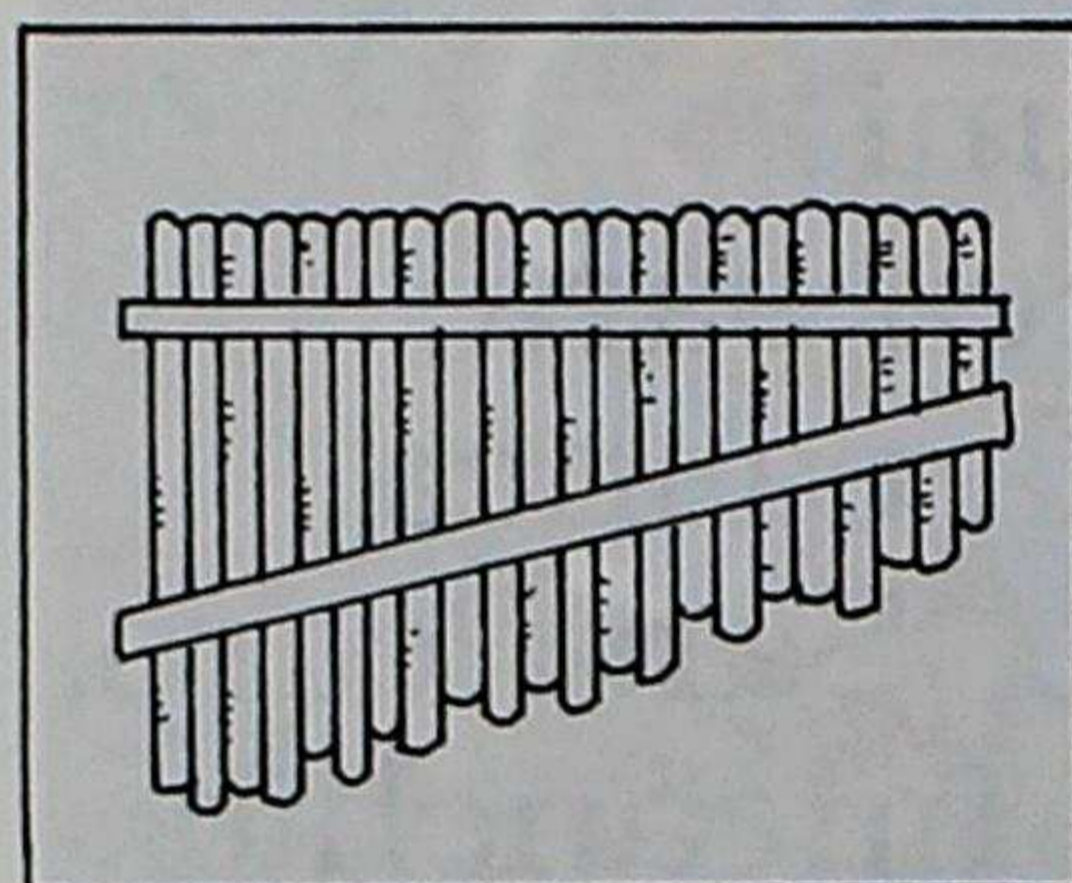

rondador

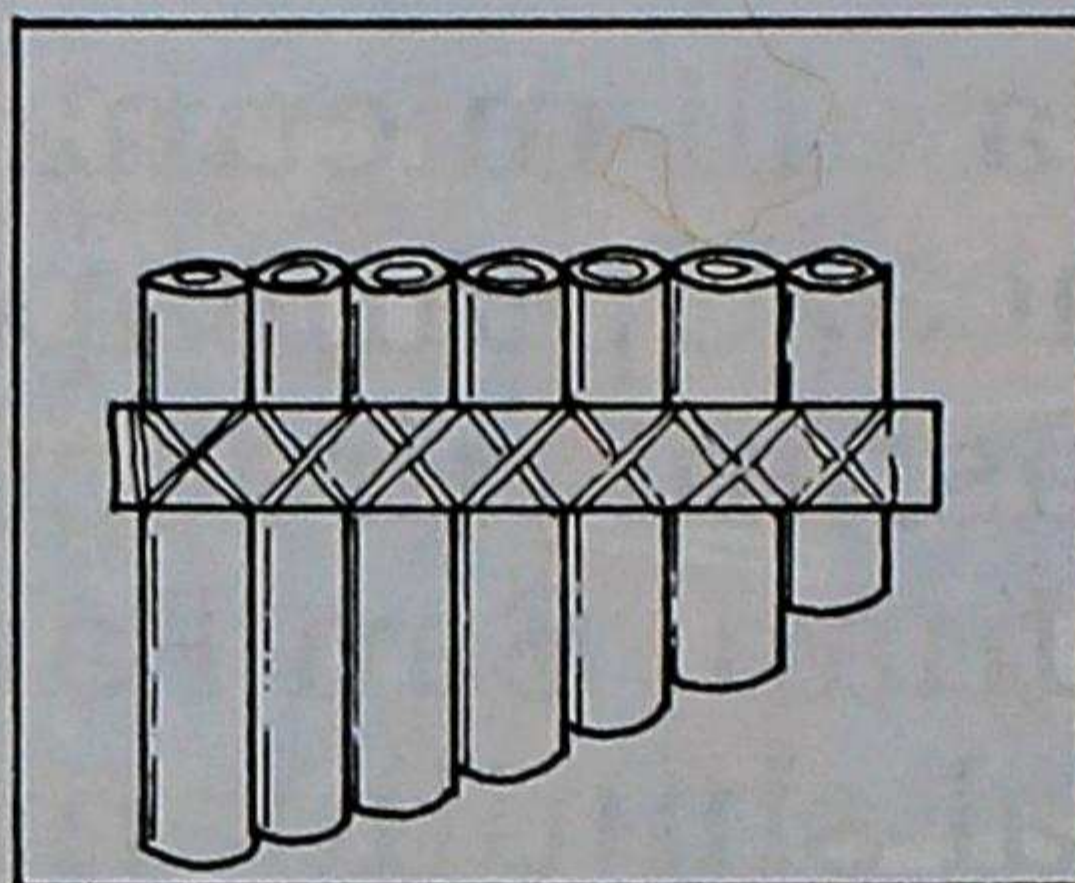

palla

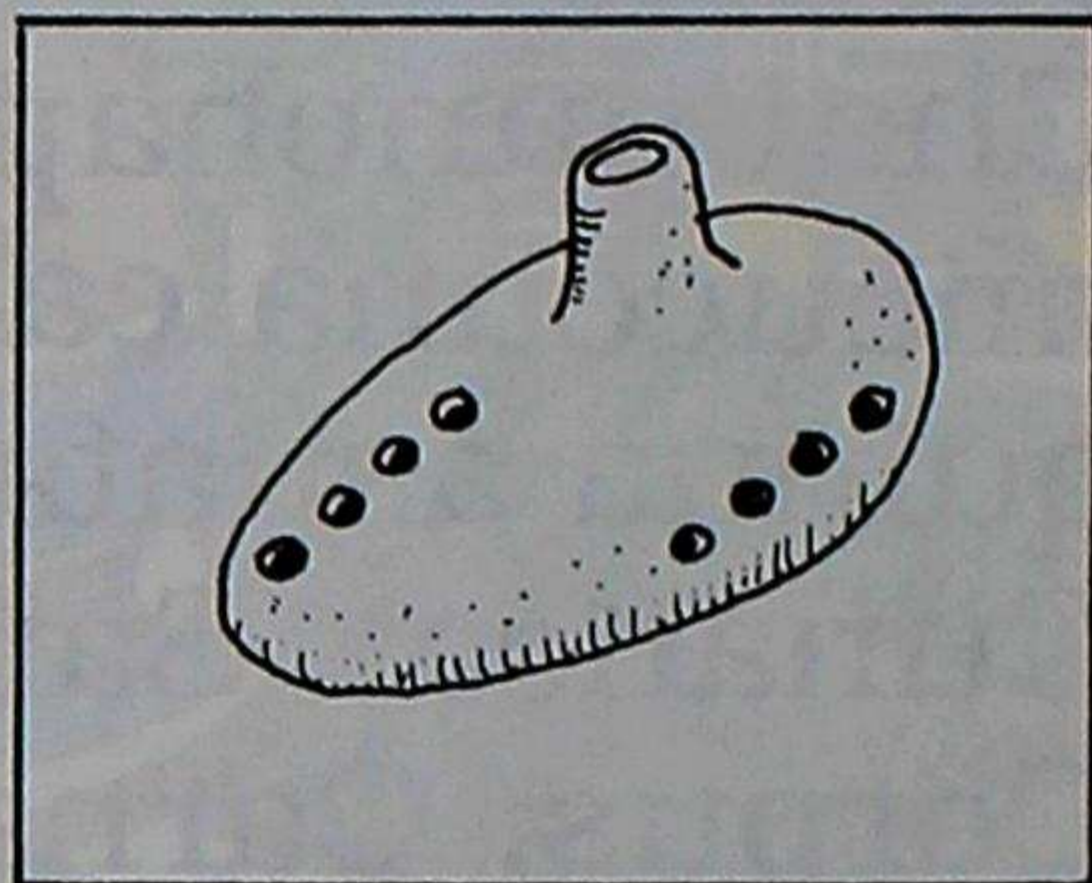

ocarina

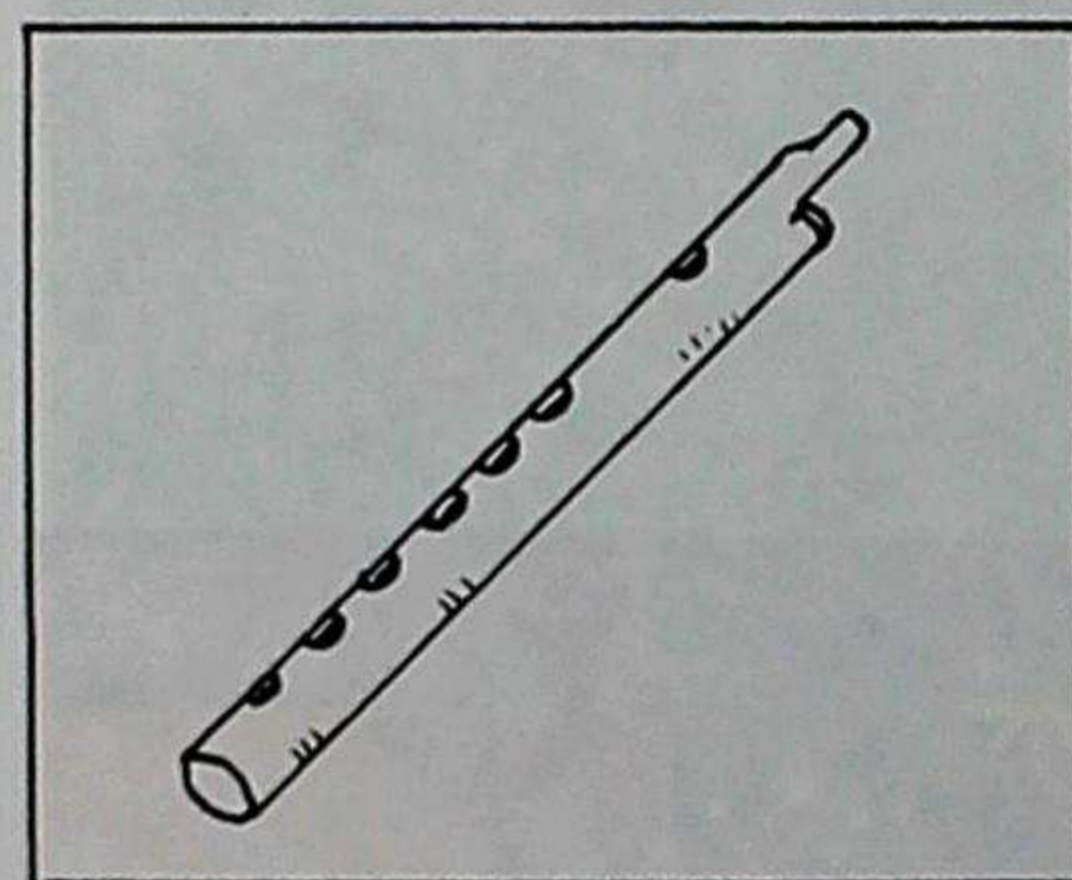

pincullu

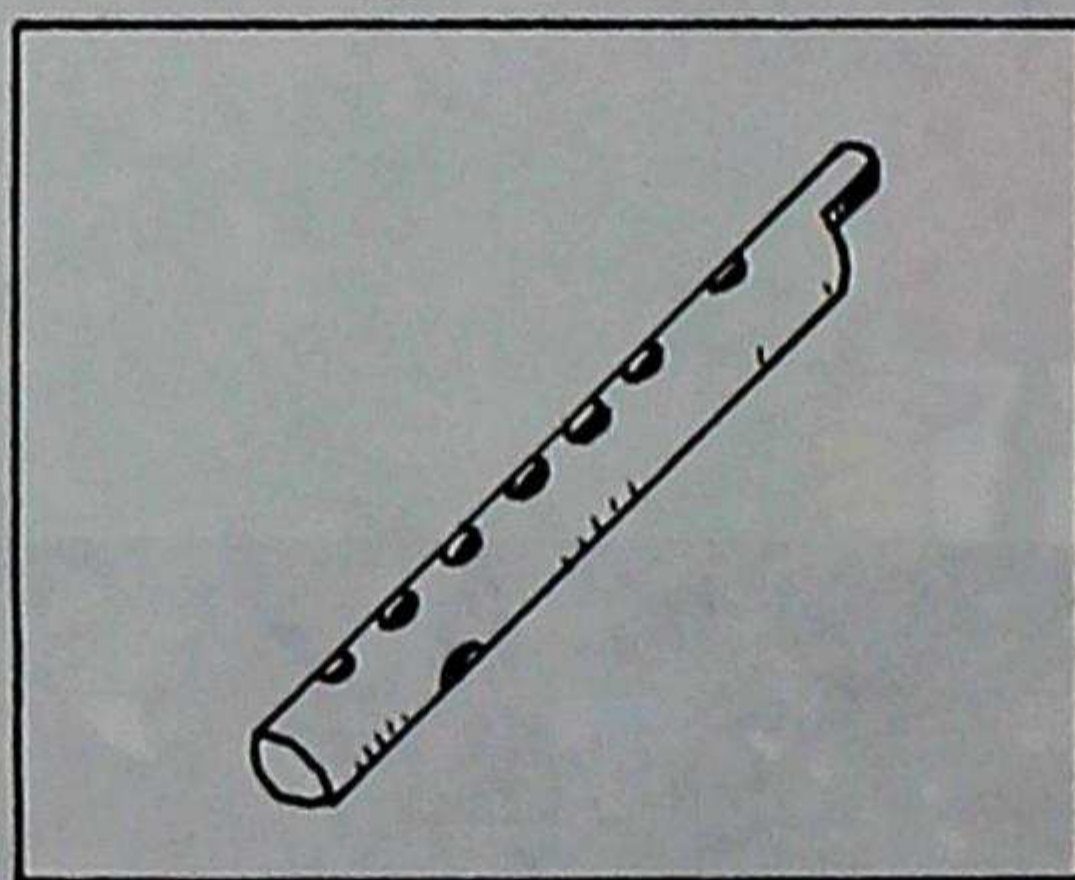

pífano

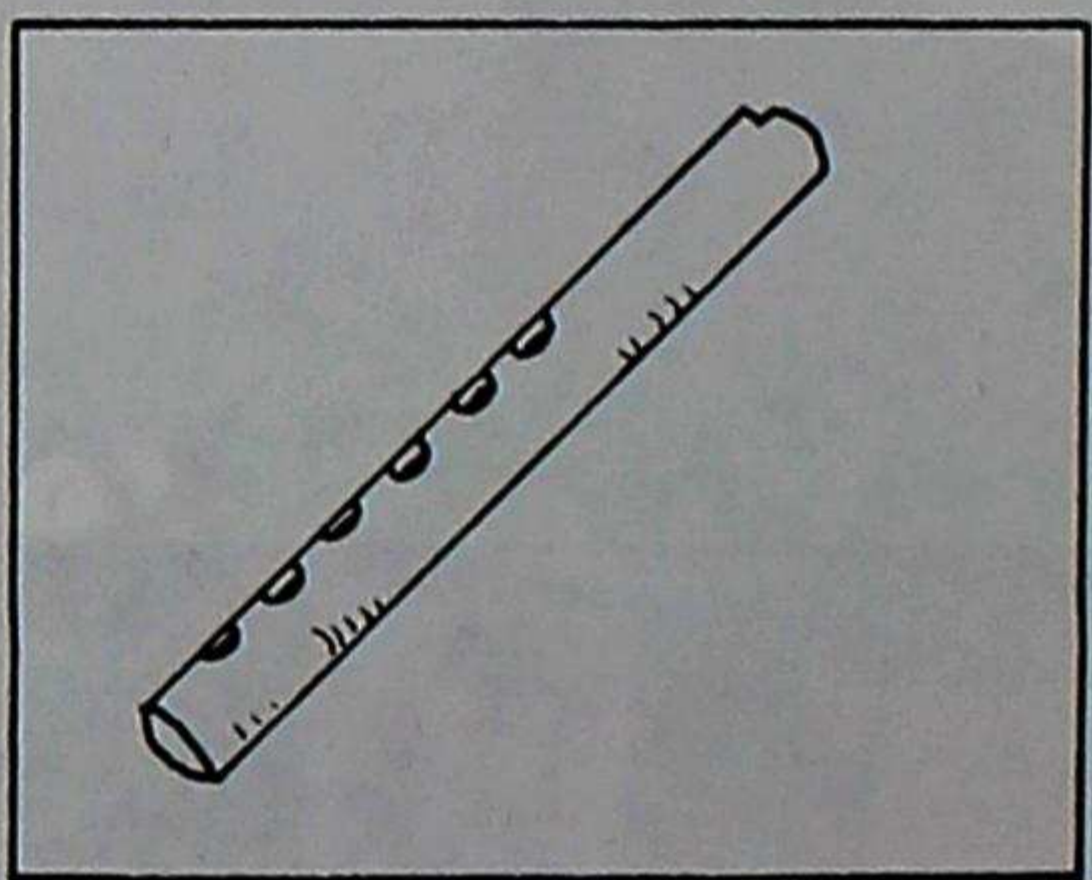

flauta

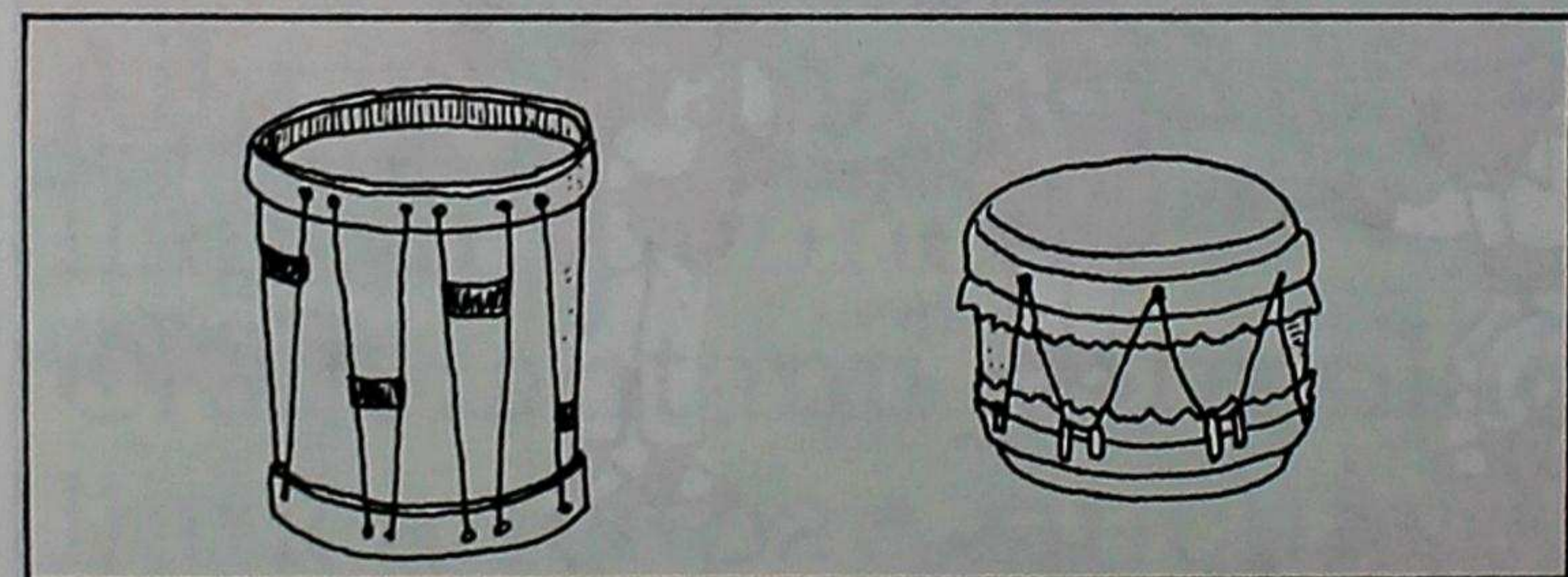

huancar



taqui

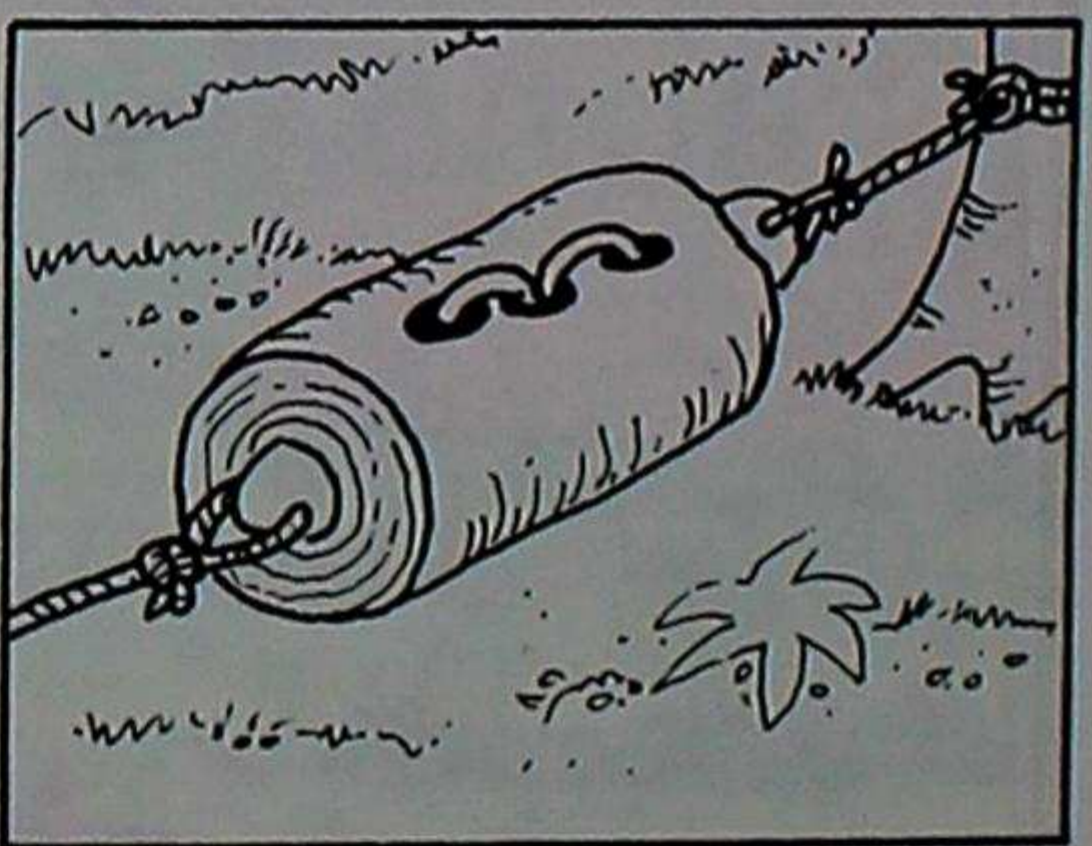

tuntulí

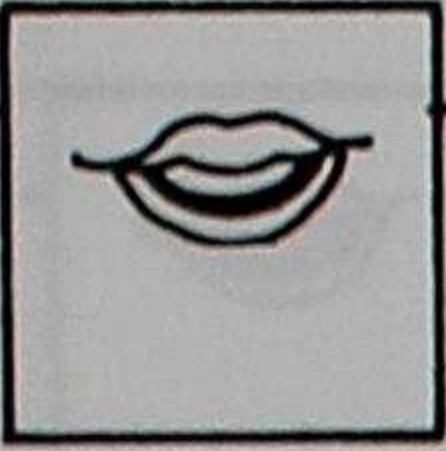

# Mama Negra raimimanta



mama negra



huahua negro

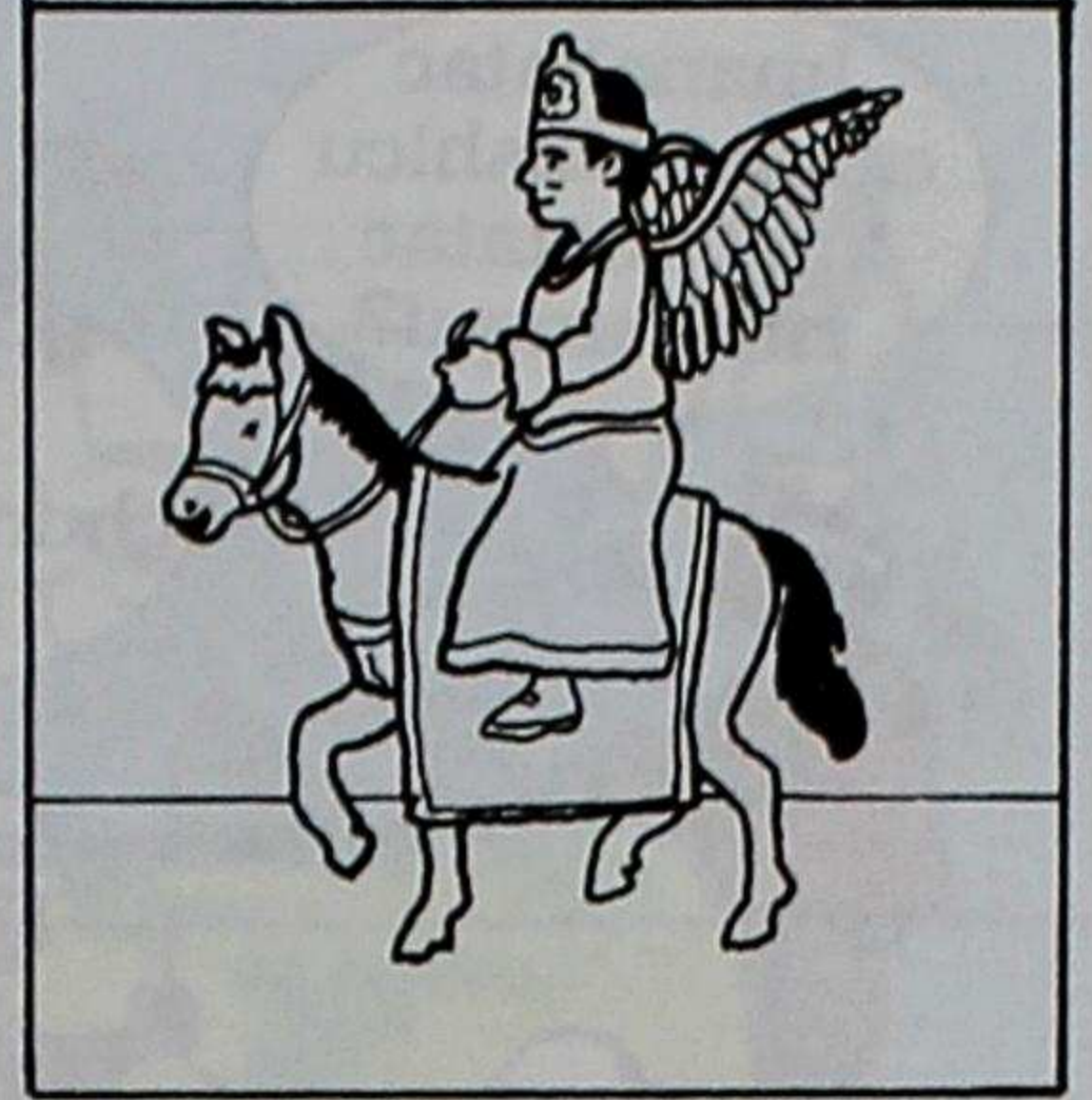

ángel



champuceros



huacus

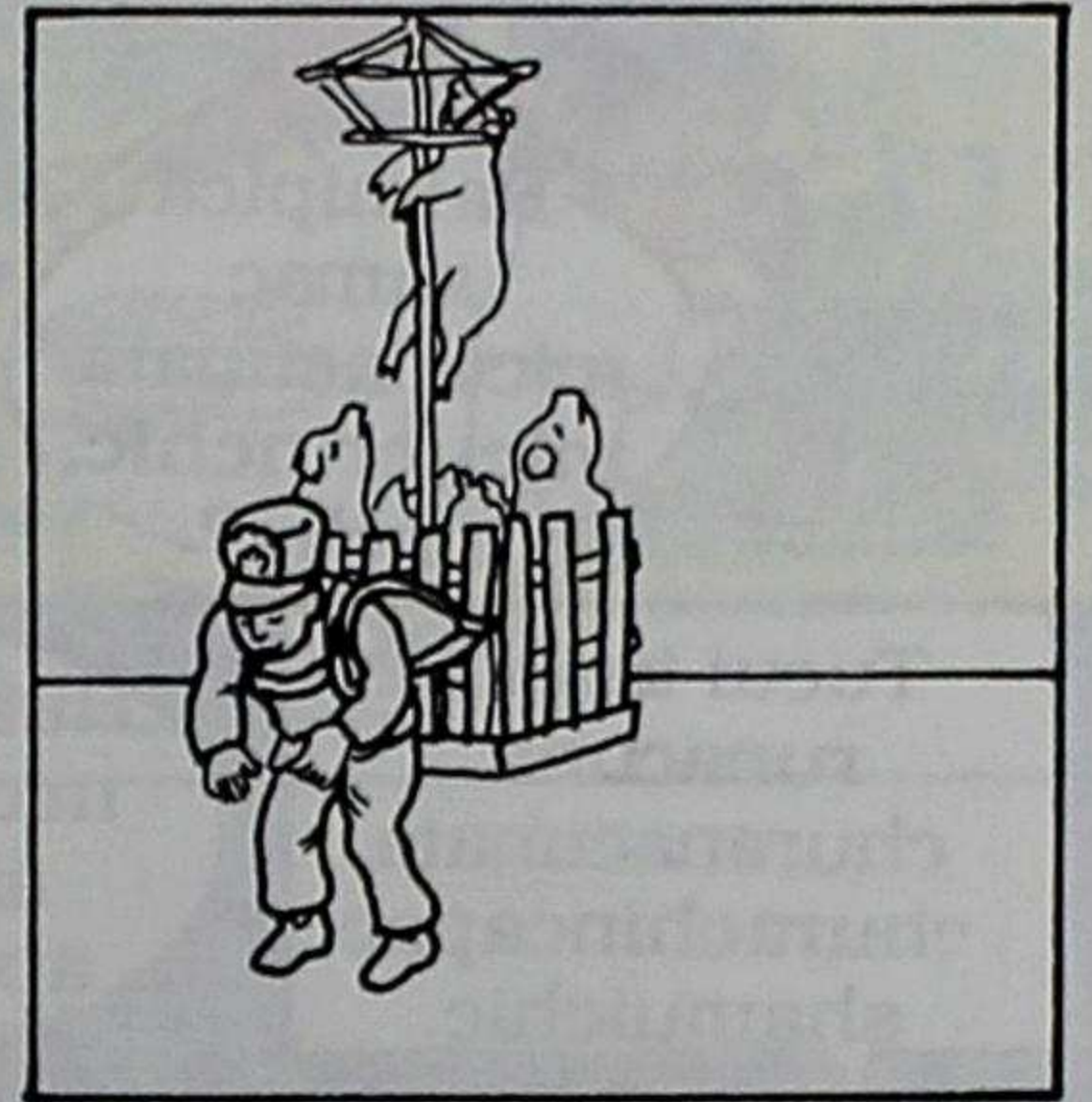

ashancac



carishina

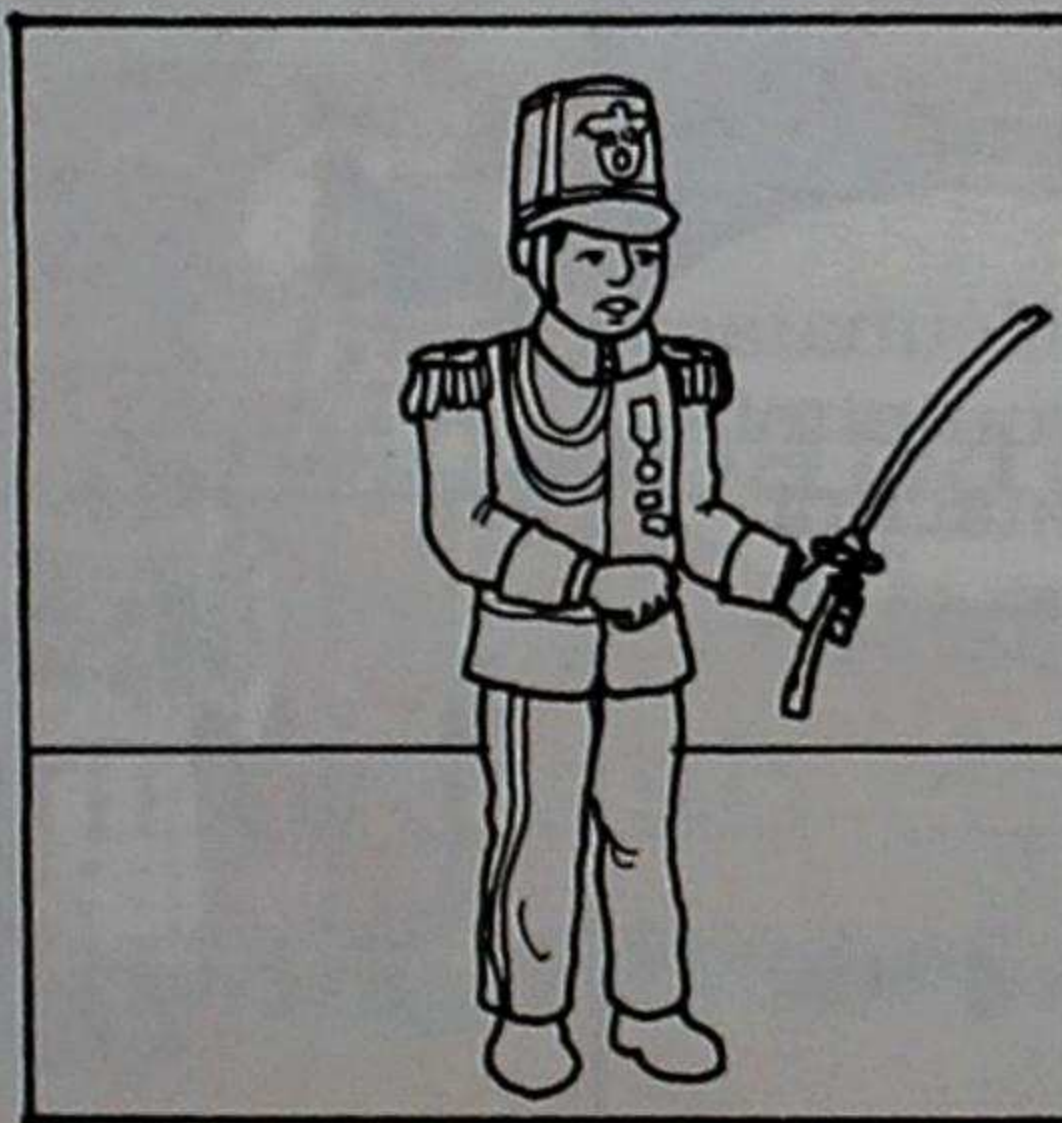

capitán

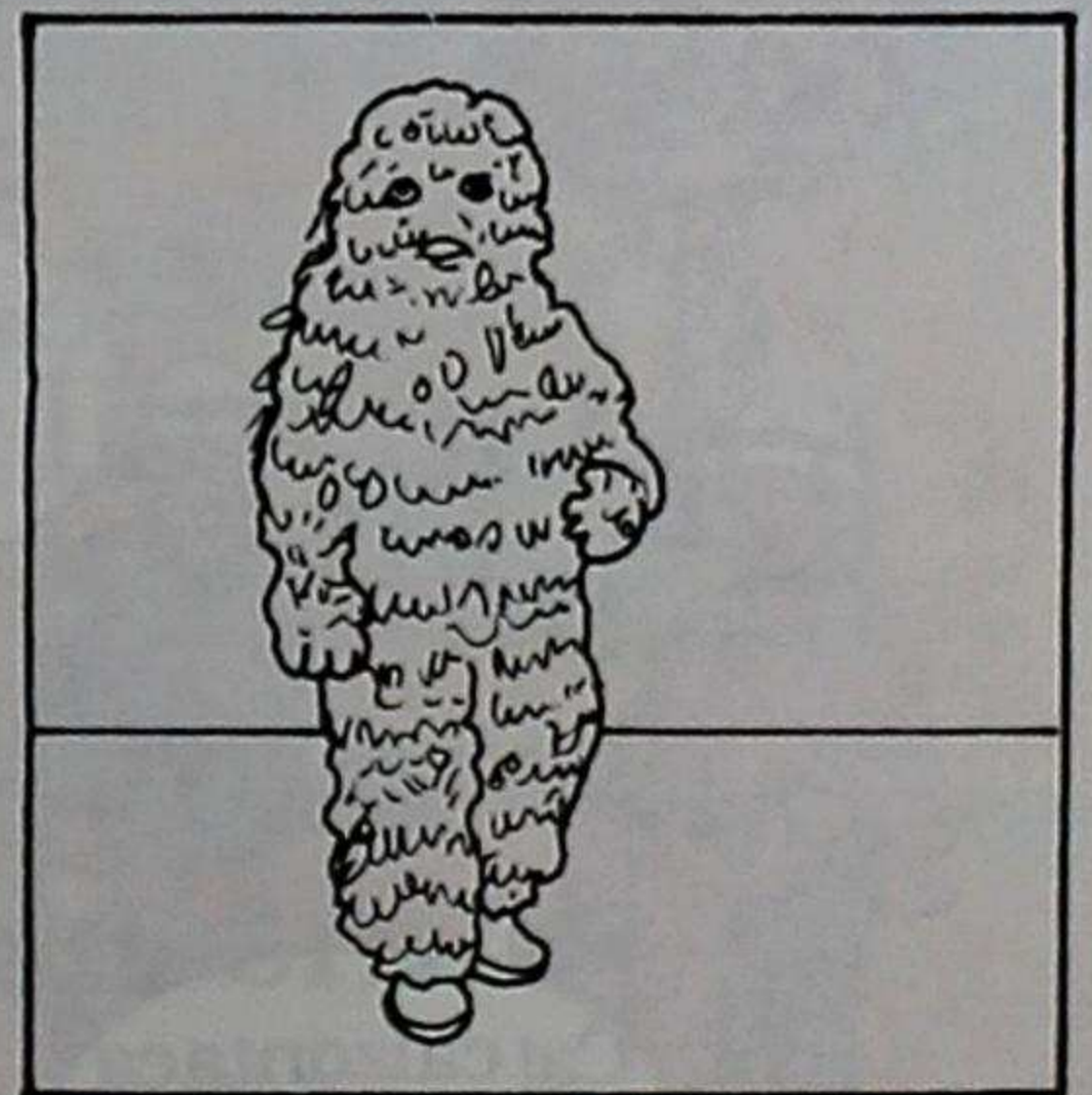

sacha runa



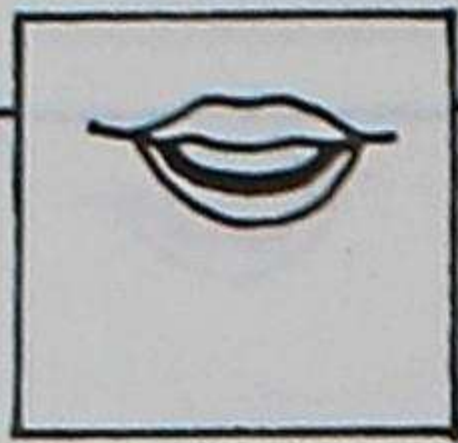

# Raimipi churarinacunamanta





# Llapincachuta rurashunchic

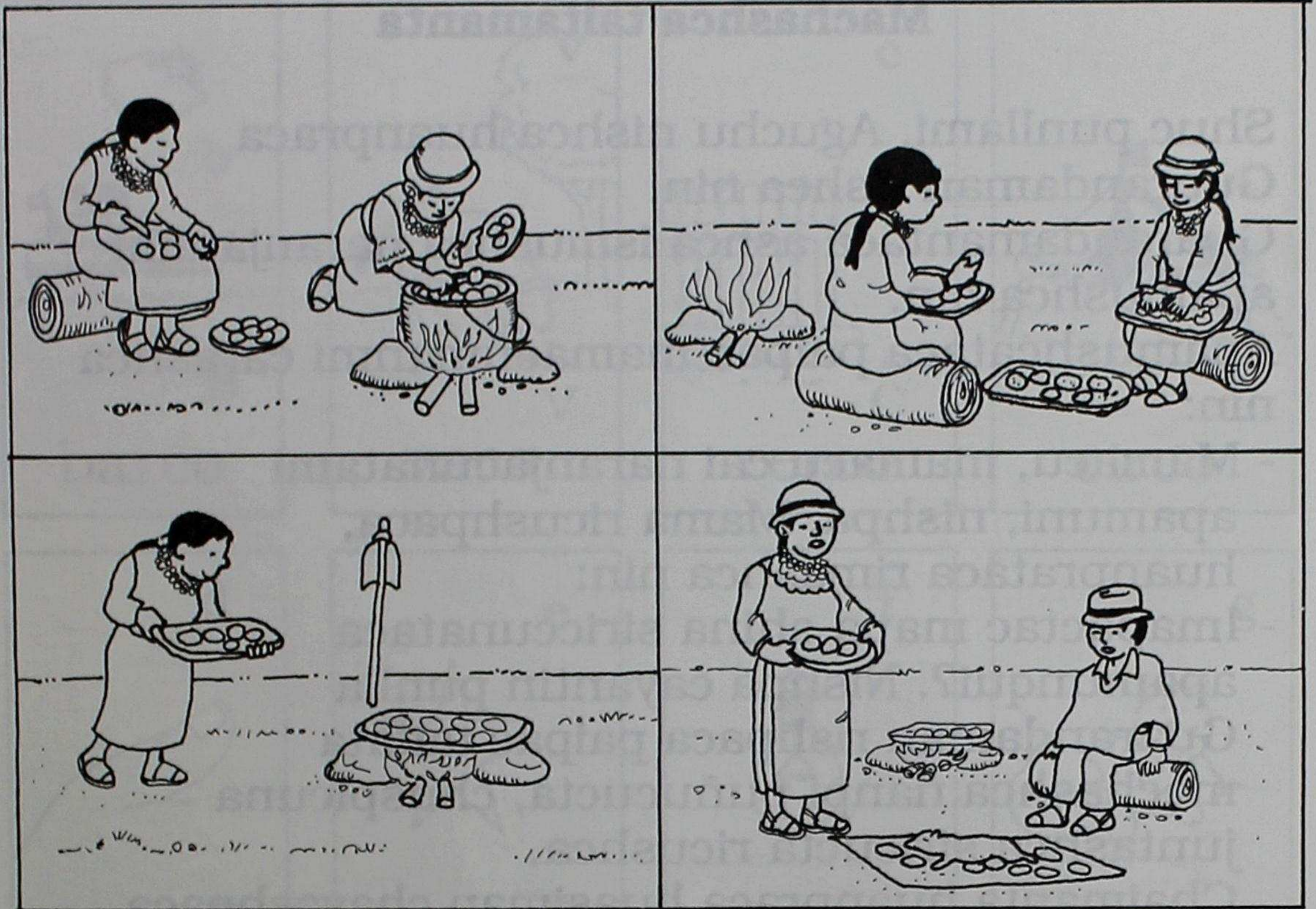

Llapincachuta rurancapacca:

- 1- Puntami ishcai maqui junta papata llushtinchic.
- 2- Mancapi ashca yacuta churashpa yanunchic.
- 3- Quipaca yanushca papata llapinchic.
- 4- Llapishca papataca ashca cachihuan, mapahuirahuanpash chapunchic.
- 5- Llapishca papahuanca tanta shina ruranchic.
- 6- Quipaca callanapi cusanchic.

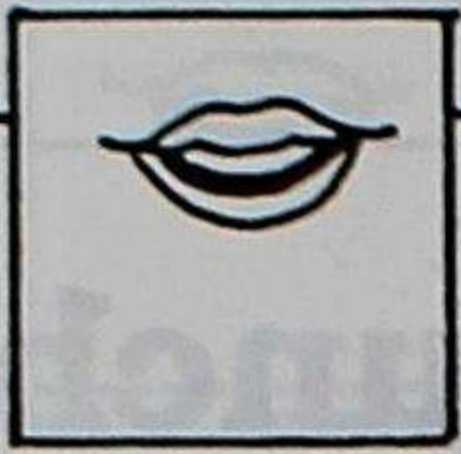

## **Machashca taitamanta**

Shuc punllami, Aguchu nishca huanpraca  
Guarandaman rishca nin.

Guarandamantaca ashca ismushca naranjatami  
apamushca nin.

Apamushcataca paipac mamacumanmi carashca  
nin:

- Mamacu, mamacu cai naranjacunatami  
apamuni, nishpa. Mama ricushpaca,  
huanprataca rimashca nin:

- Imapactac mapa shina siriccunataca  
apamunqui?. Nishpa cayantin punlla  
Guarandaman rishpaca paipac taitata  
machashca ñanpi puñucucta, chuspicona  
juntashca siricucta ricushca.

Chaimanta huanpraca huasiman chayashpaca  
mamaman cashna huillashca:

- Mamacu, mamacu taitaca Guarandapimi  
machashca mapa shina shitashca siricun.  
Imanishpatac mana pushamurcanqui?. Nishpa,  
mamaca tapushca.

- Nachu mamacullatac nircanqui mapa shina  
siriccunataca ama apamunquichu, chaimanta  
mana apamurcanichu, nishpami huahuaca  
cutichishca.

Huillac: Francisco Toalombo.

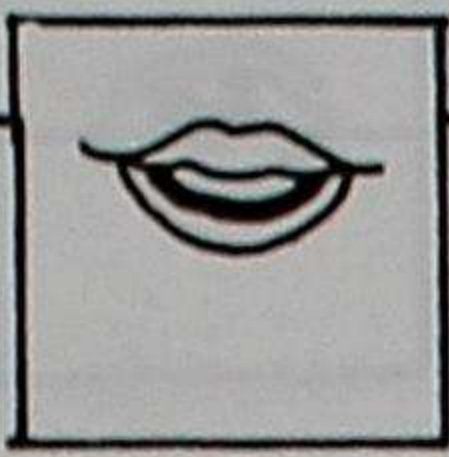

# Castellanomanta quillcacuna

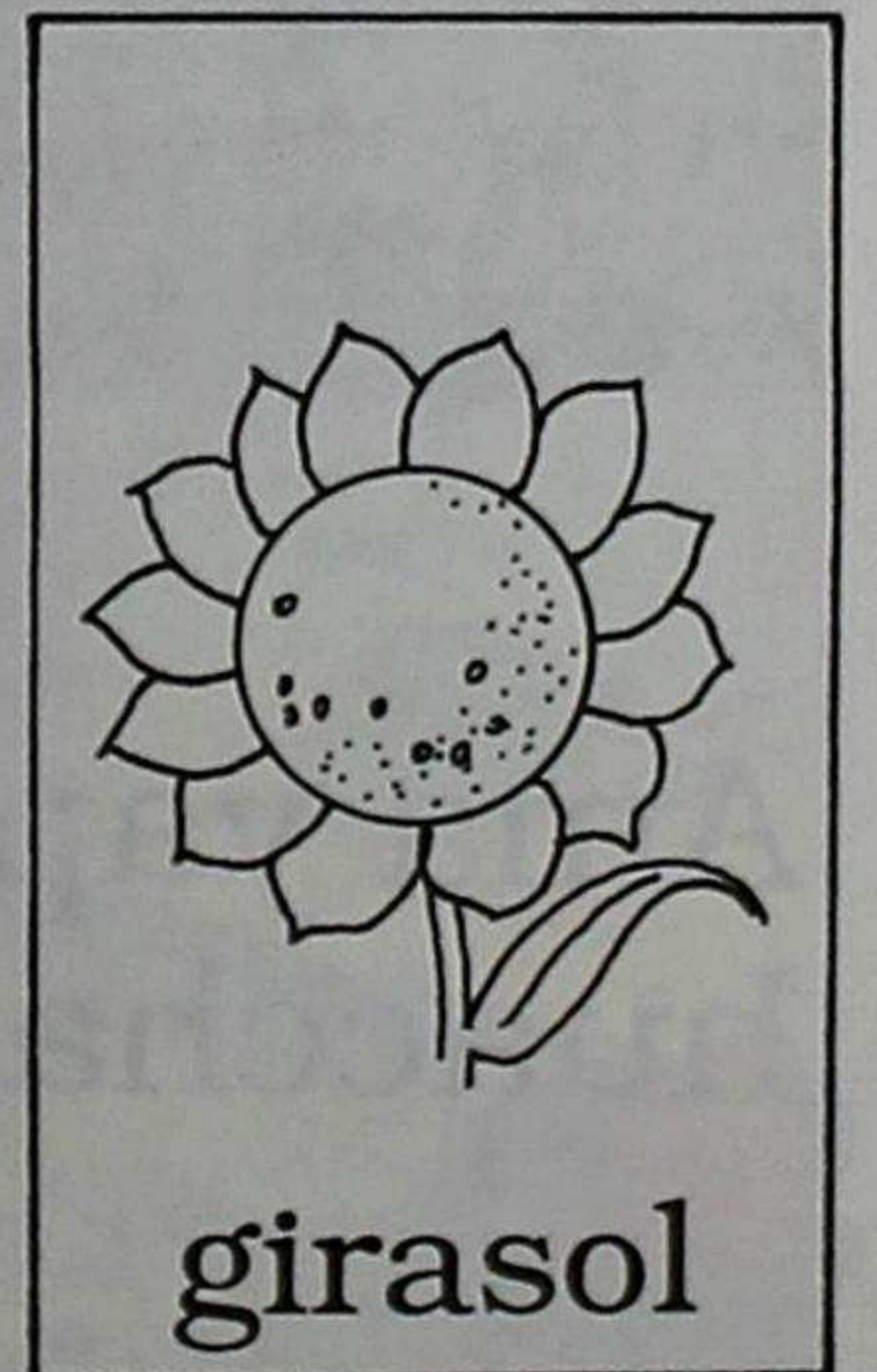
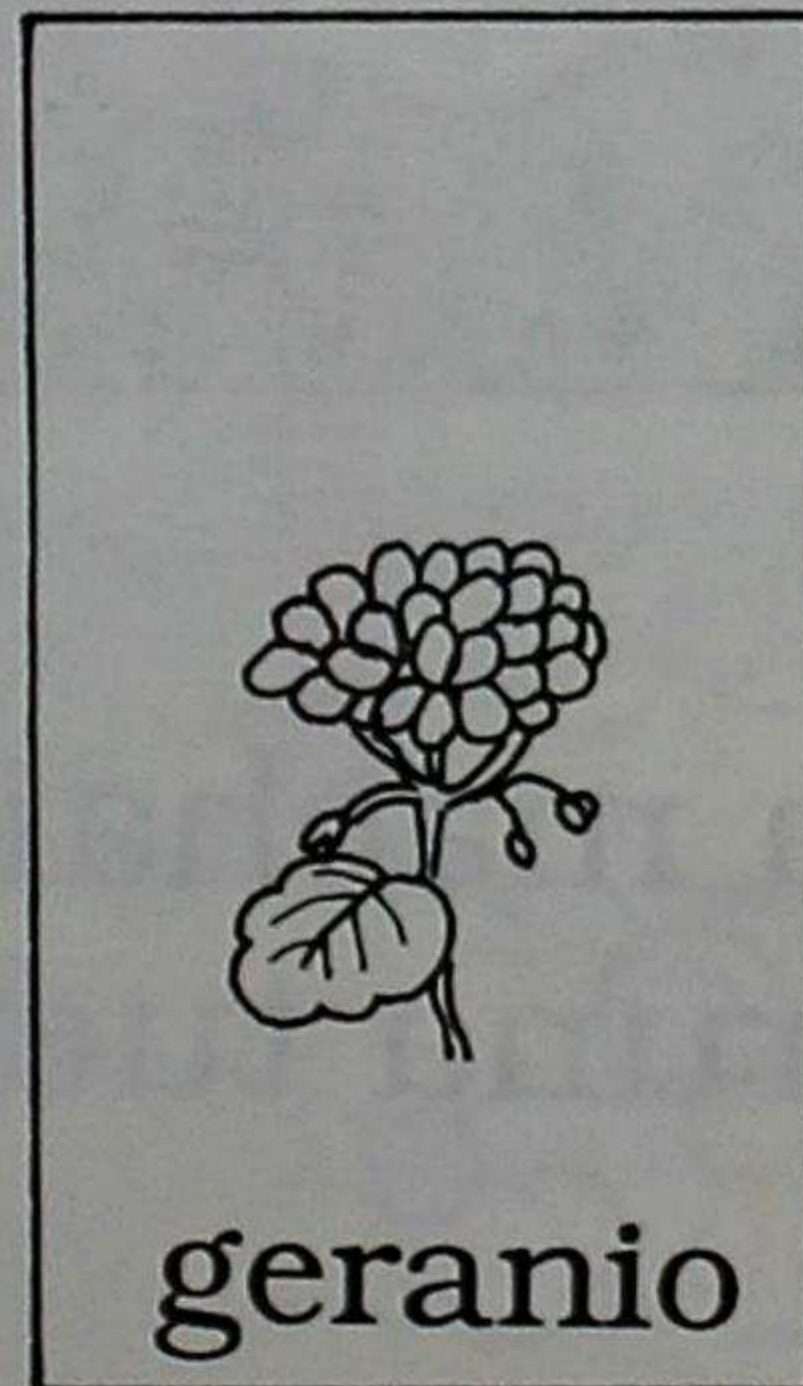
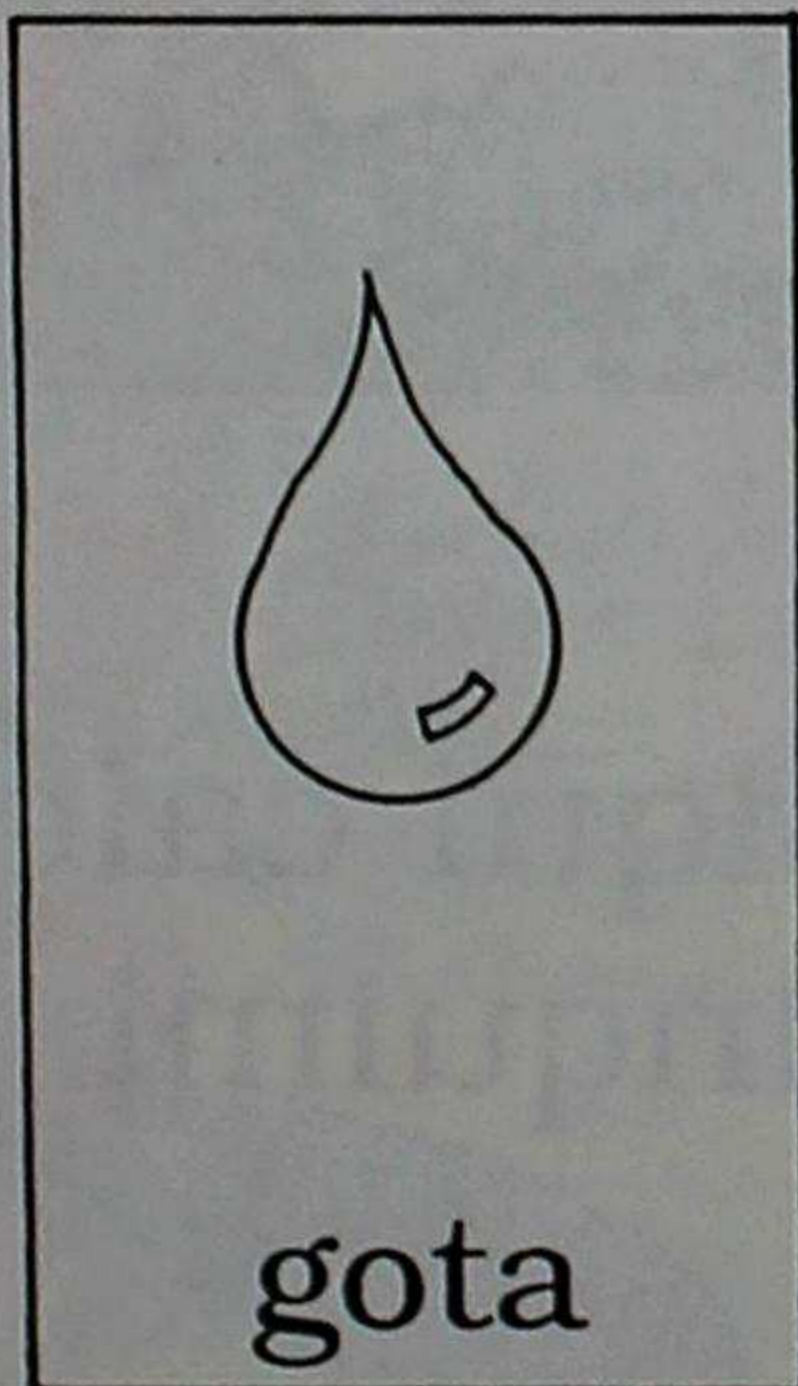
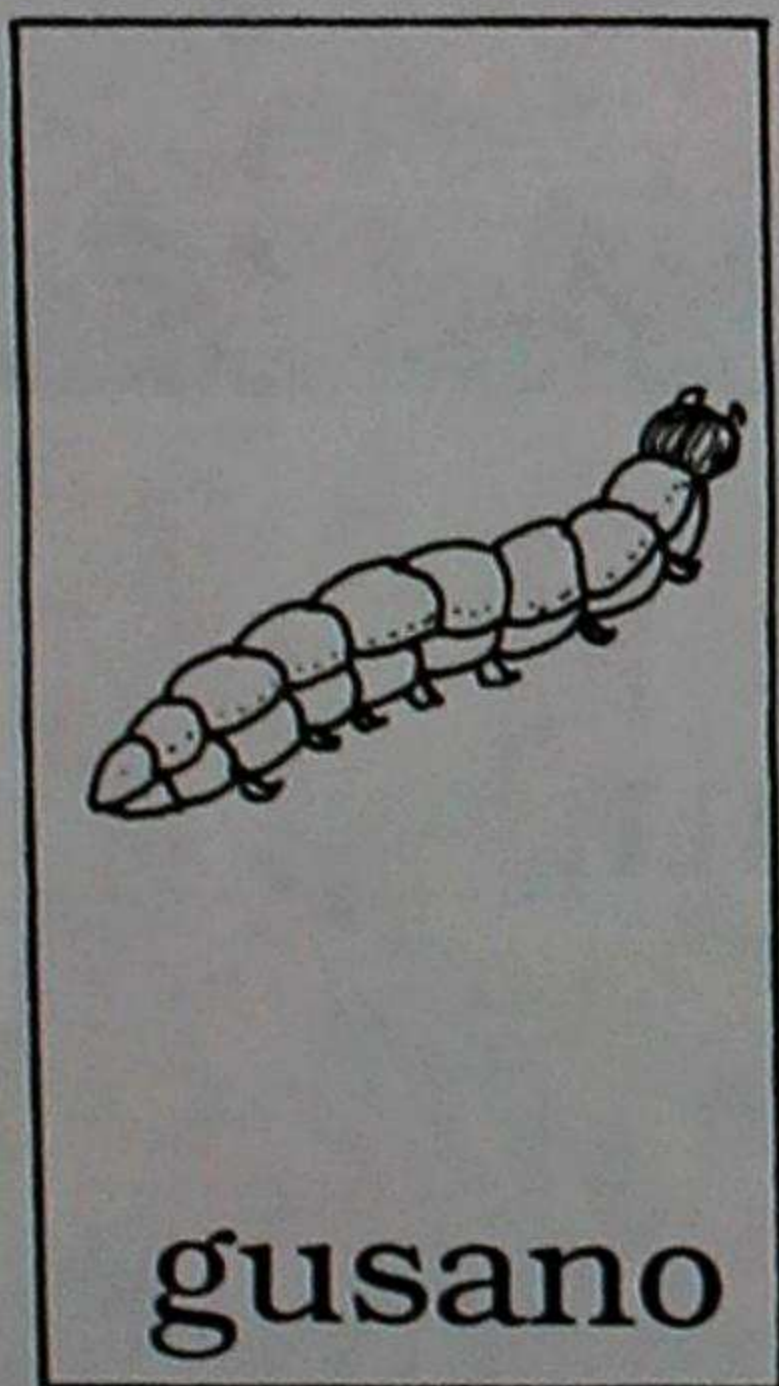
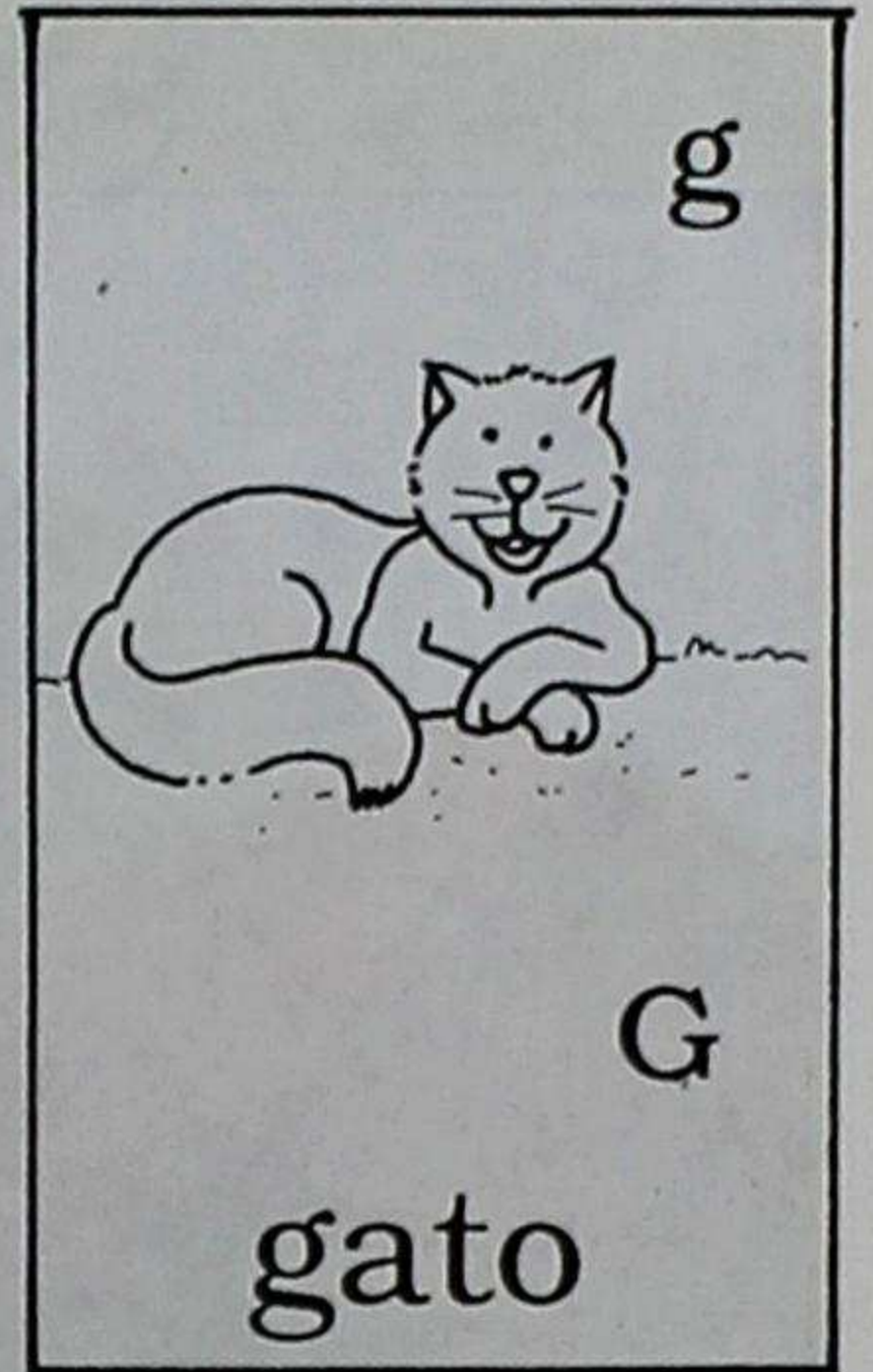
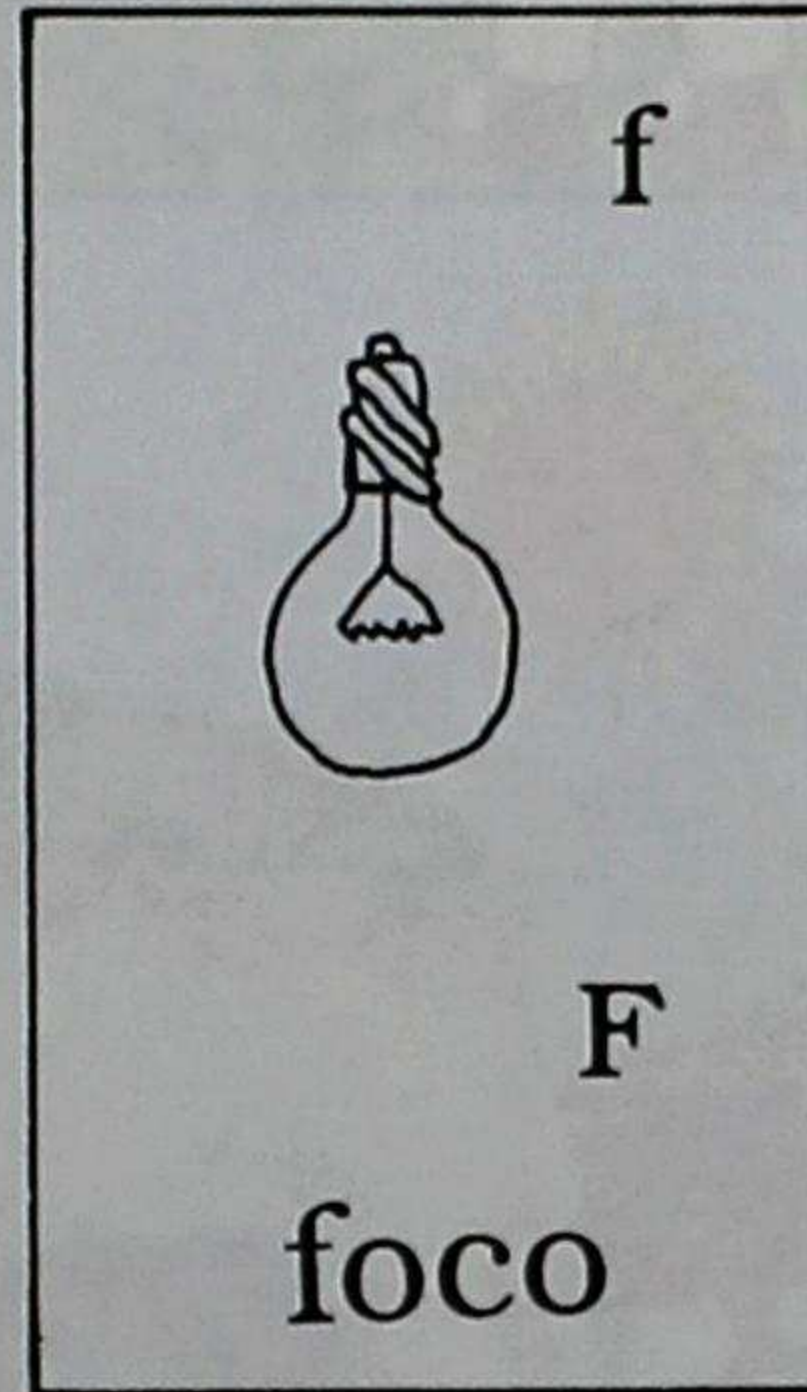
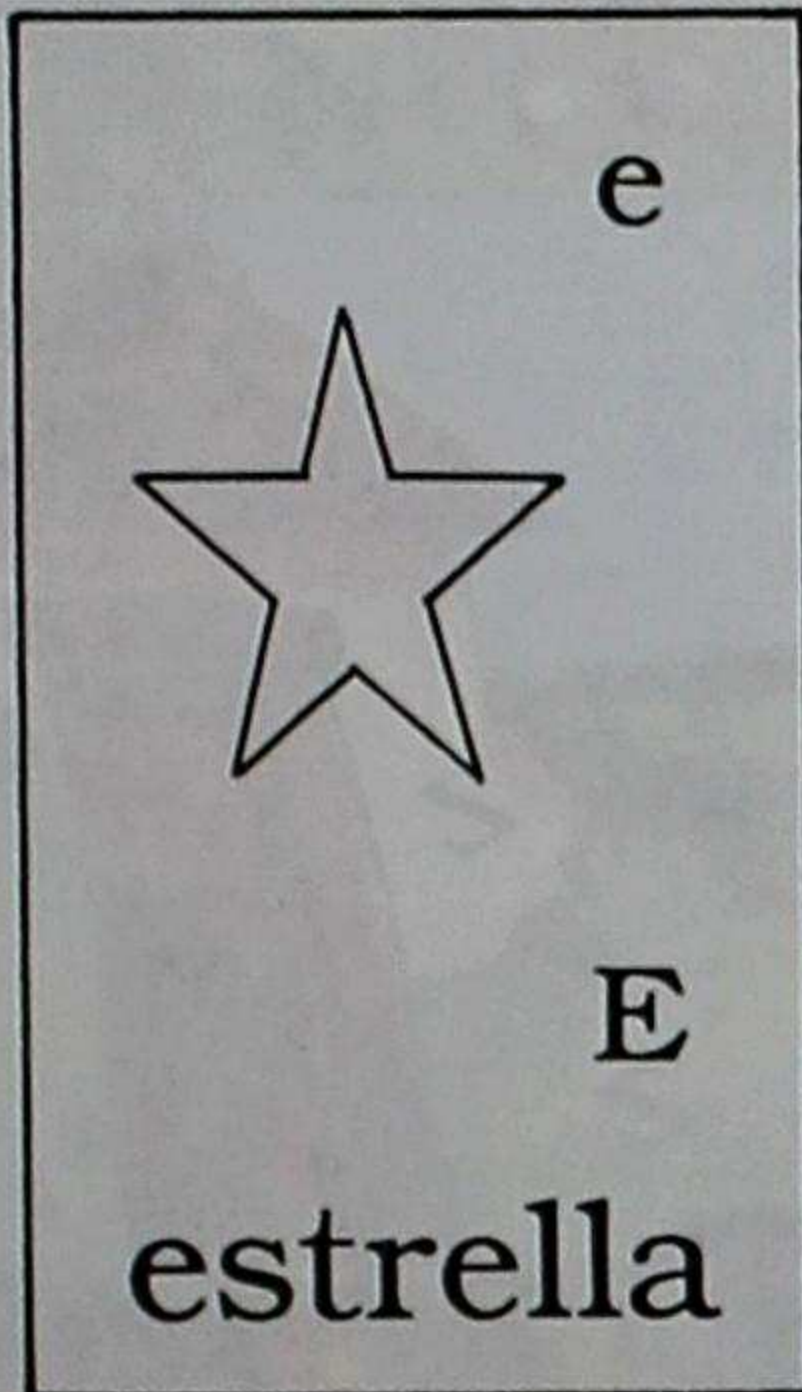
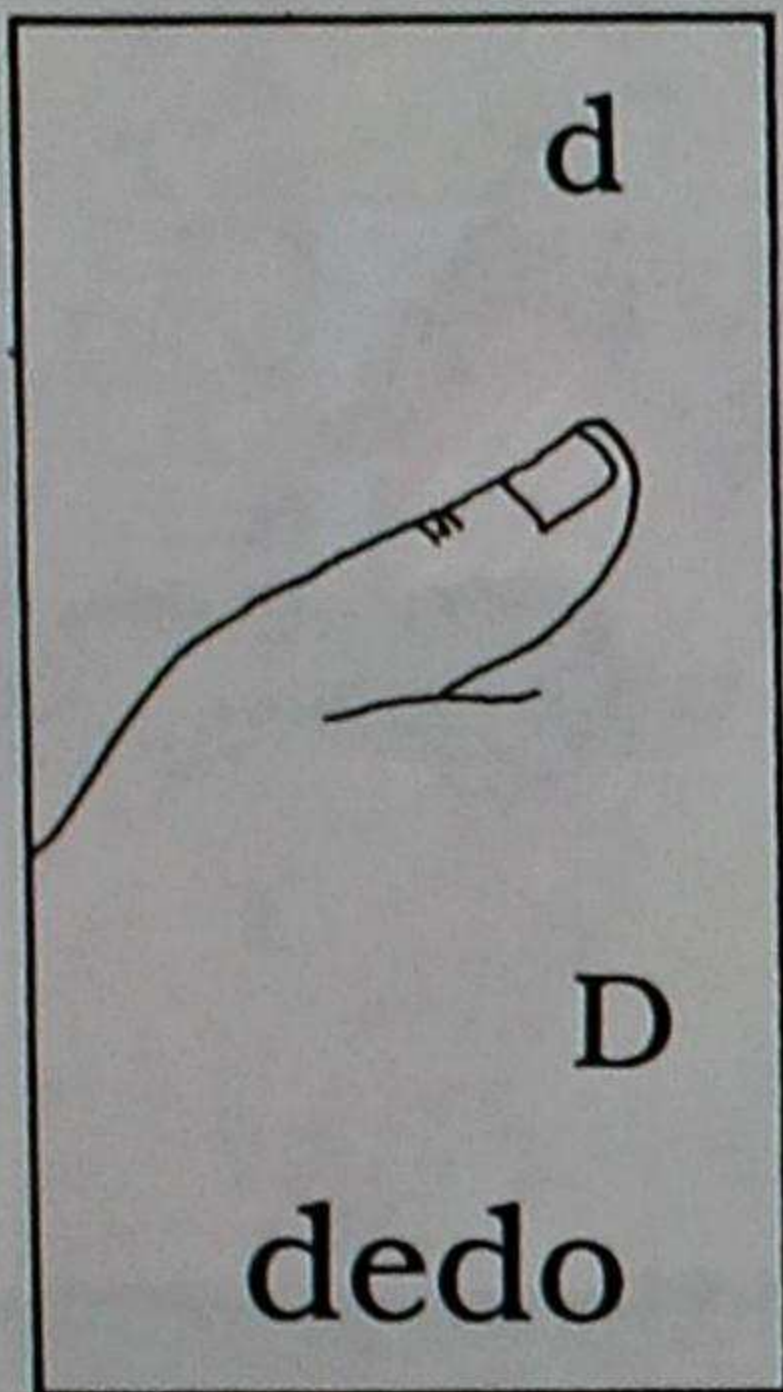
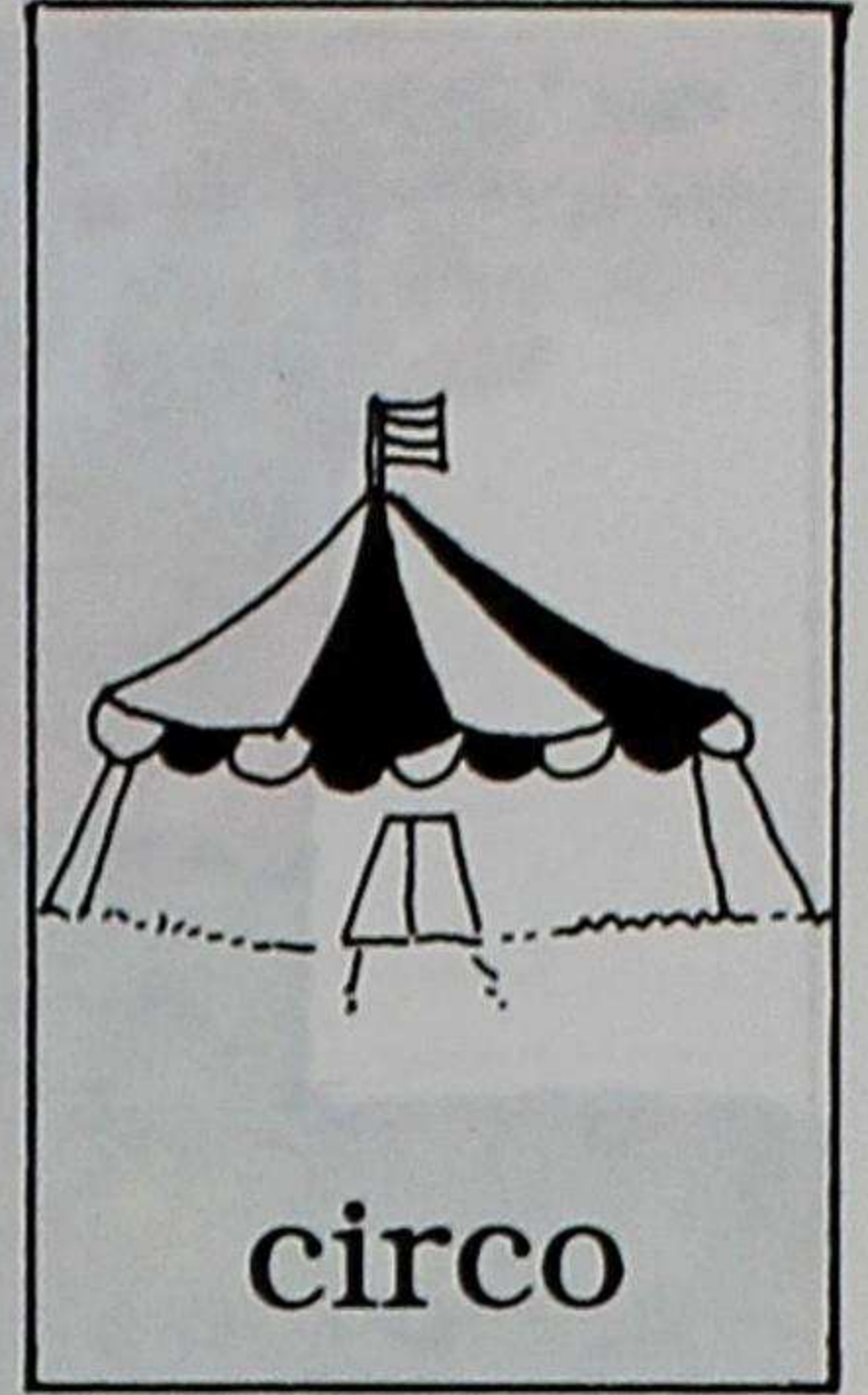
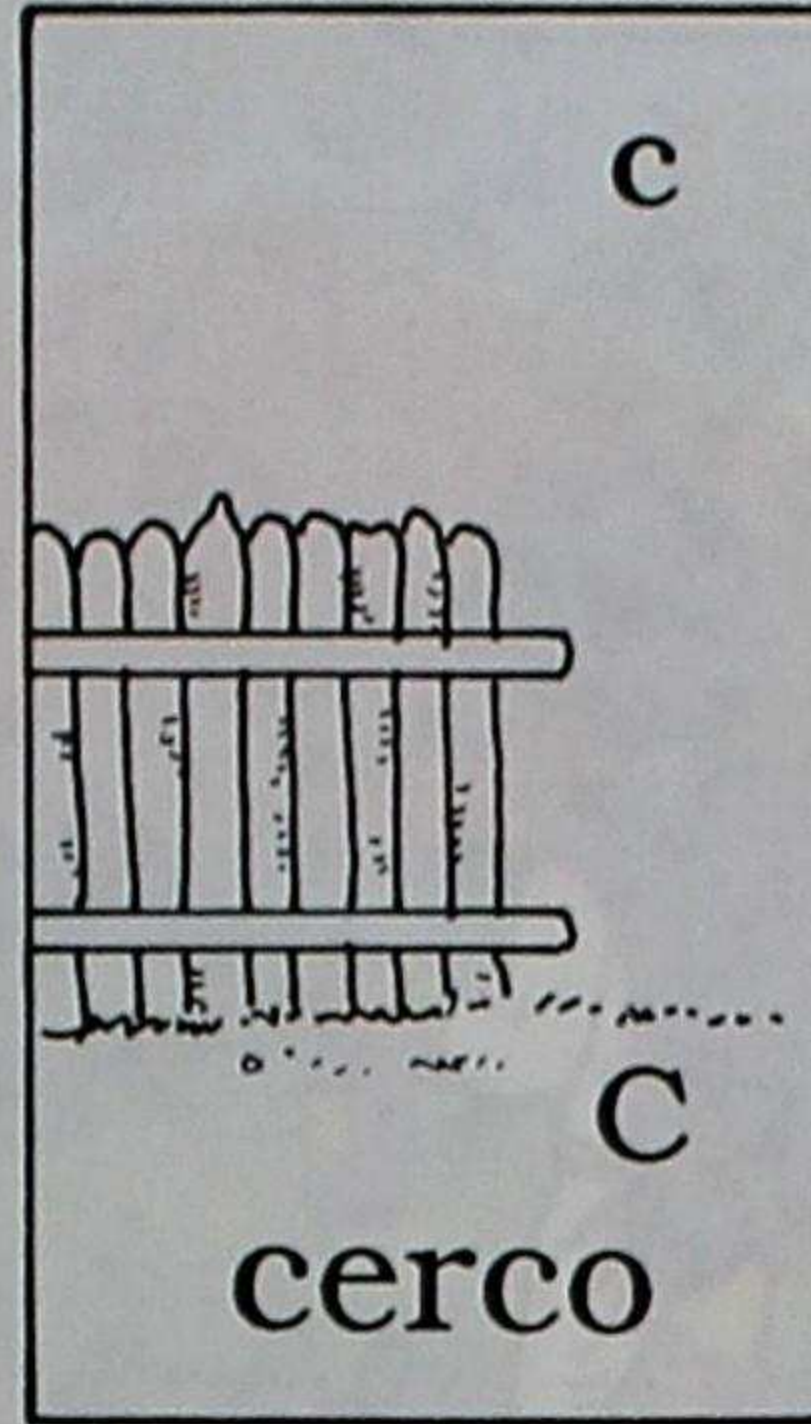
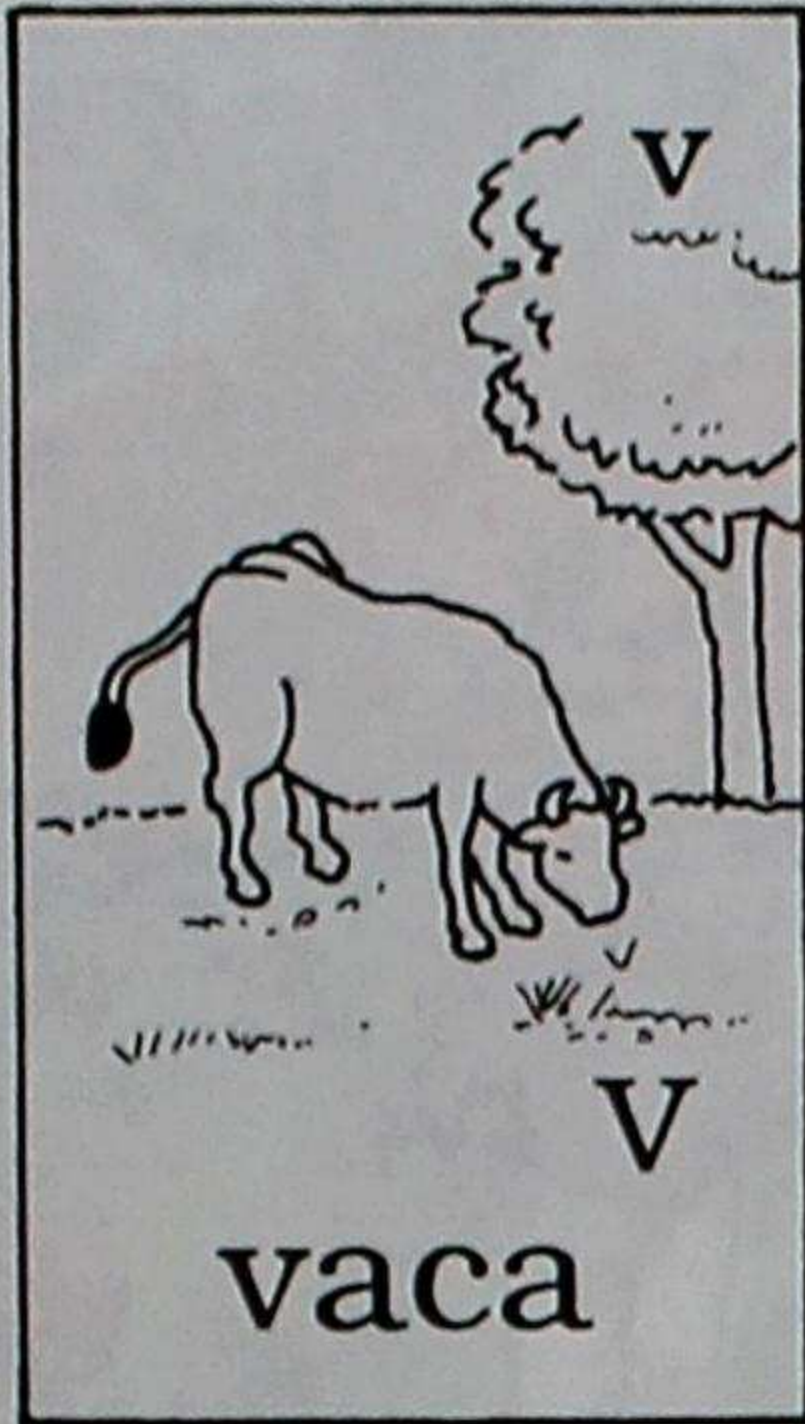
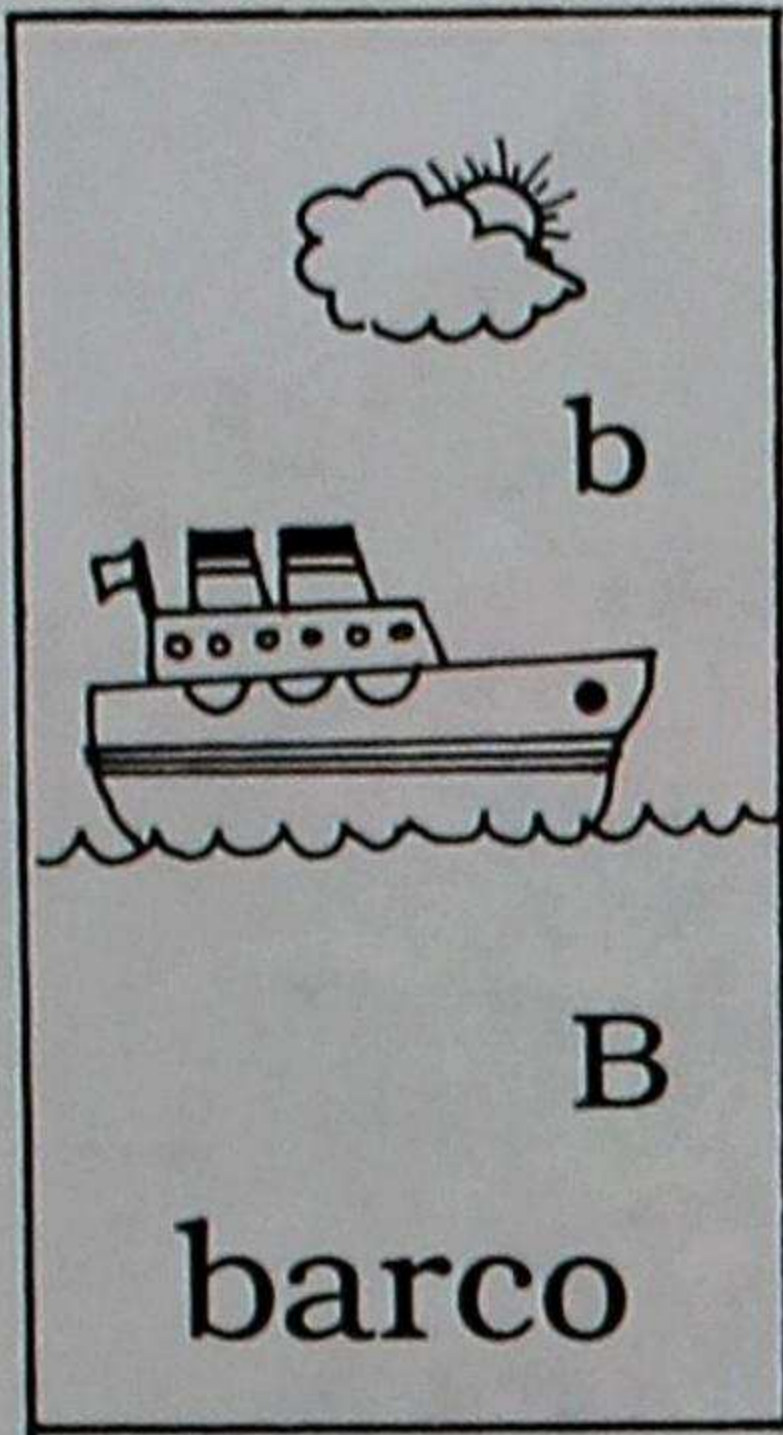

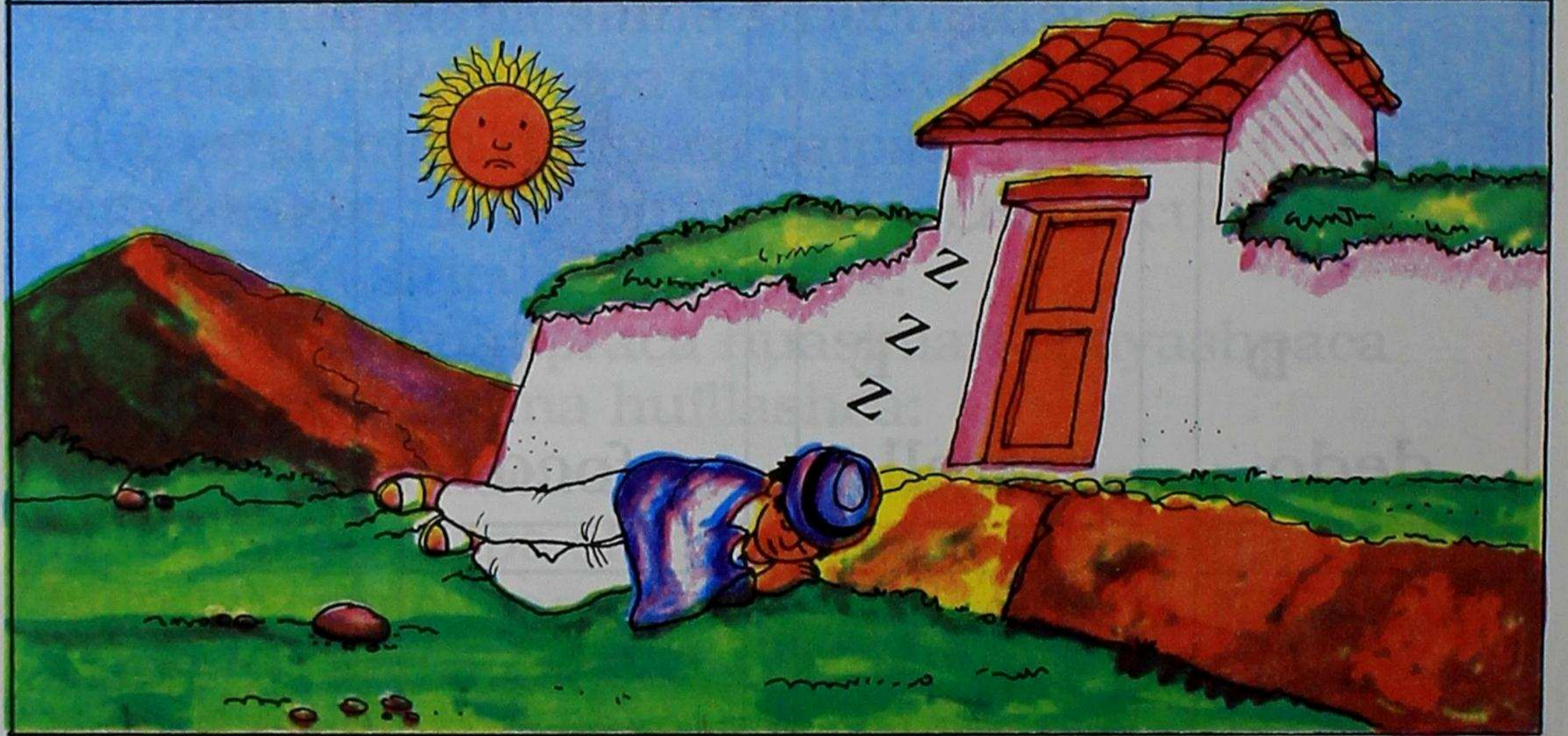
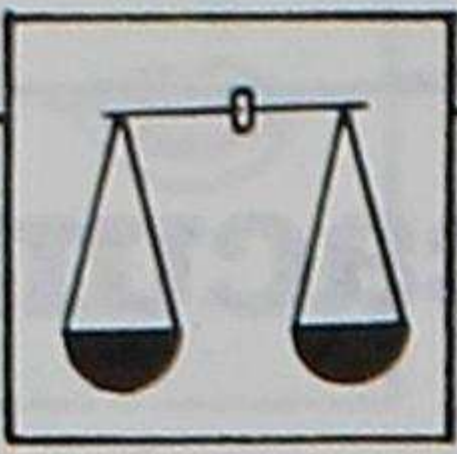

Ama yapa machaisiqui caichu,  
huaccha runa tucunquimi.

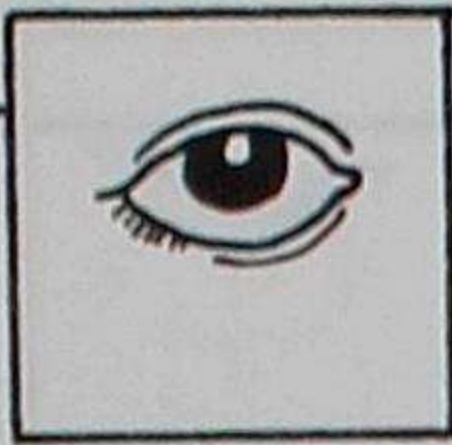

# Yuracunamanta

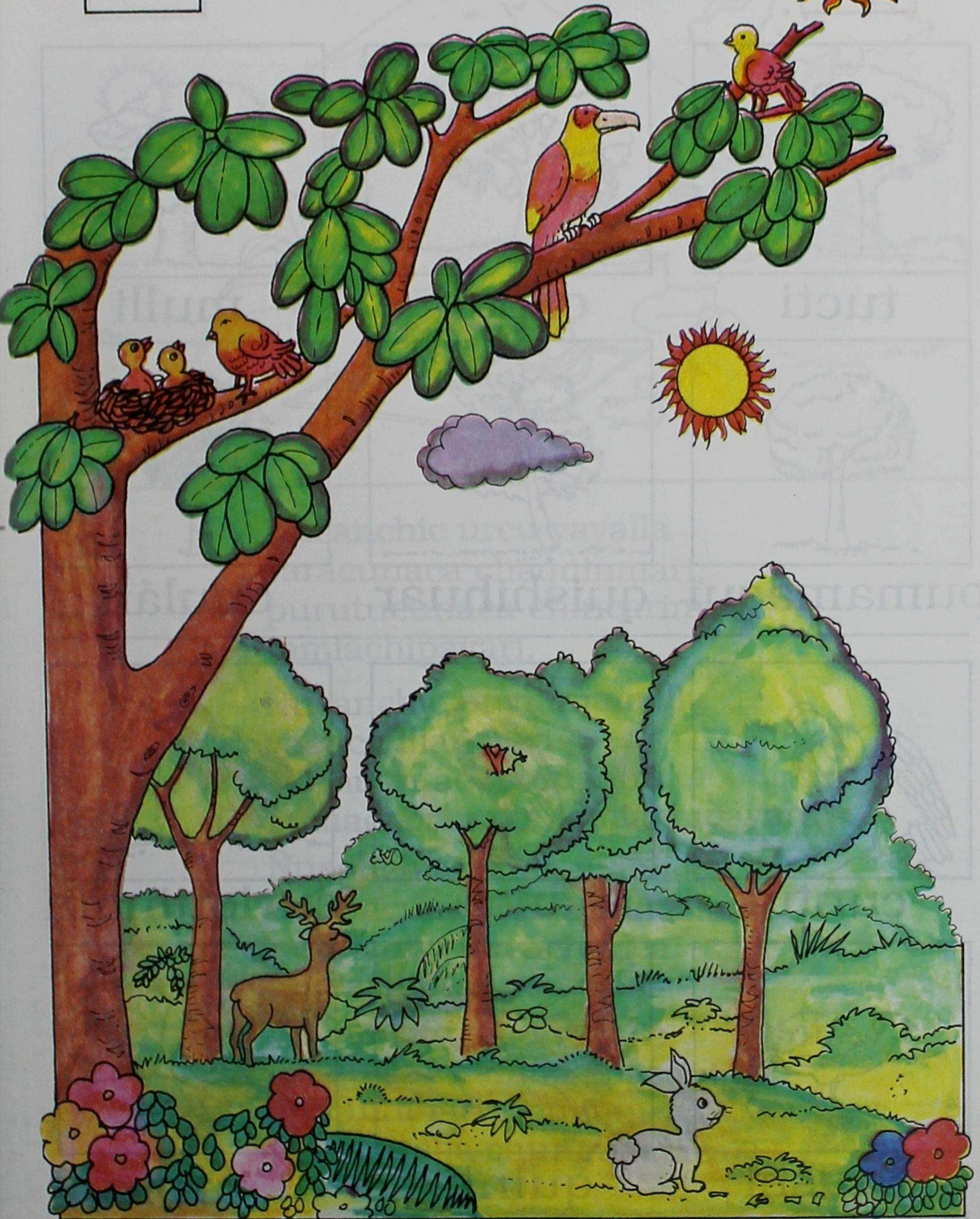

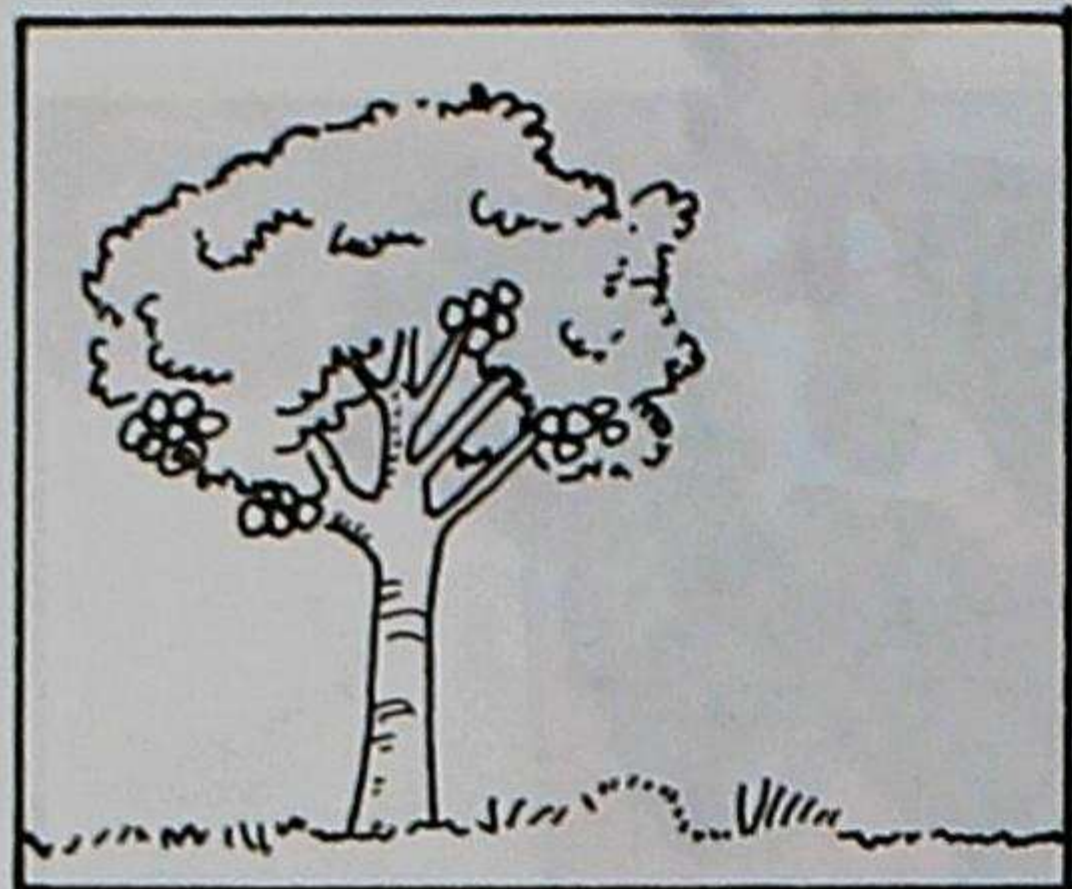
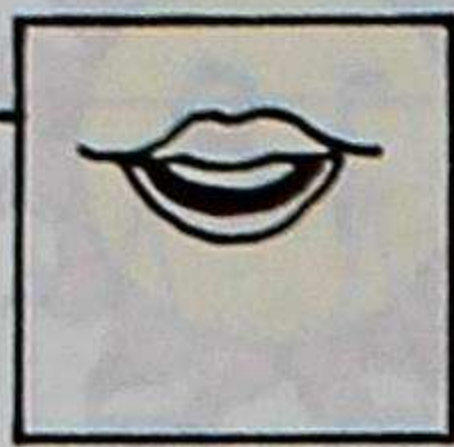

tucti

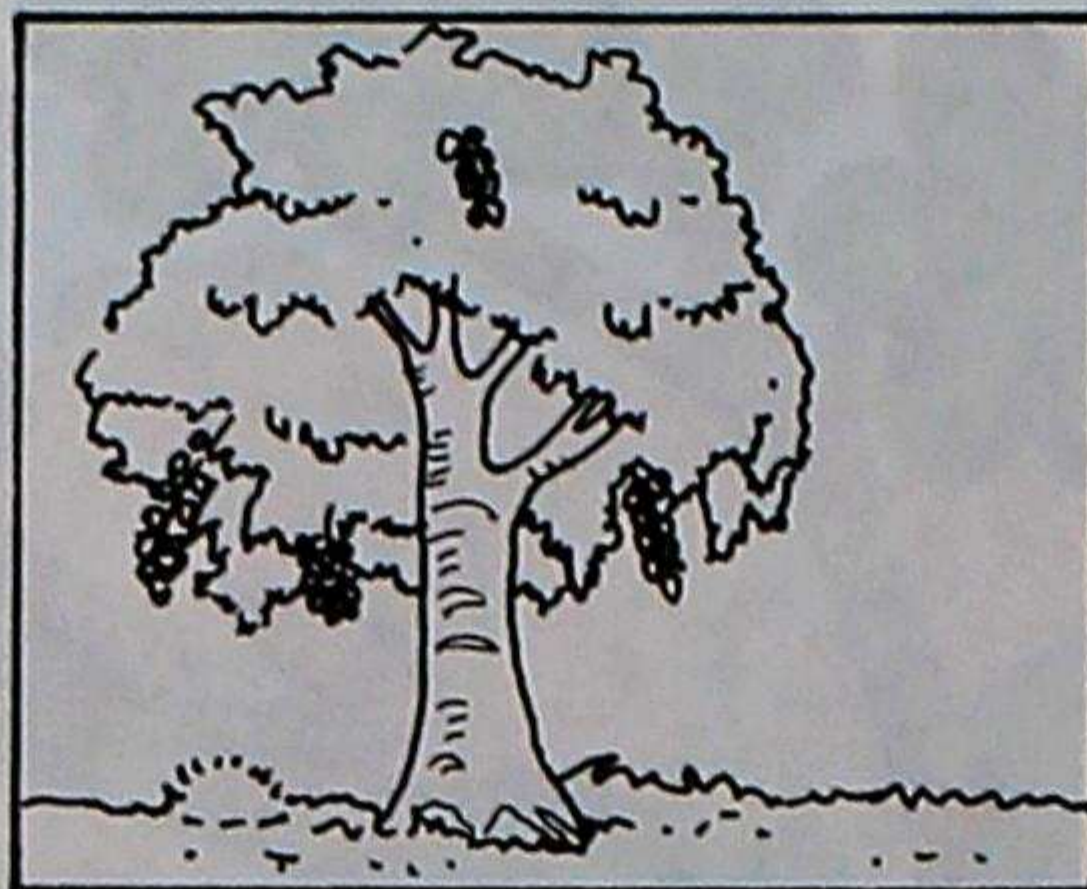

capuli

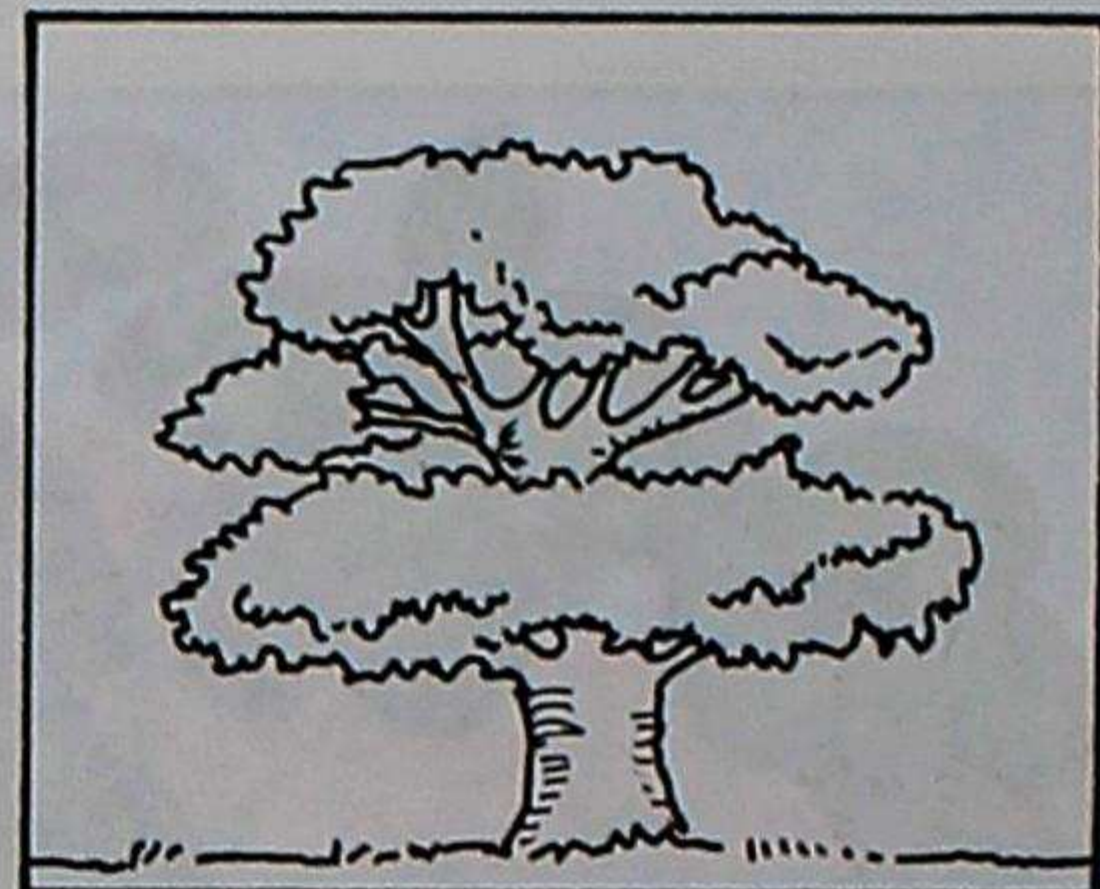

mulli

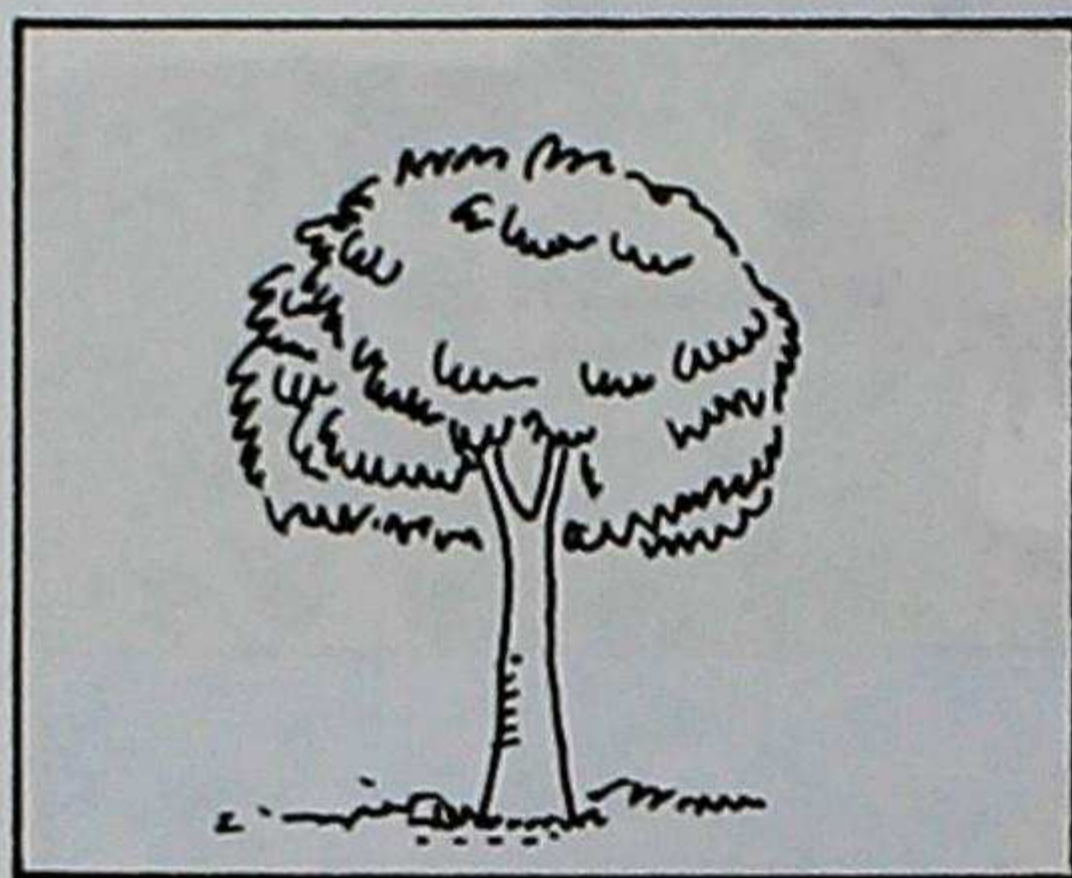

pumamaqui

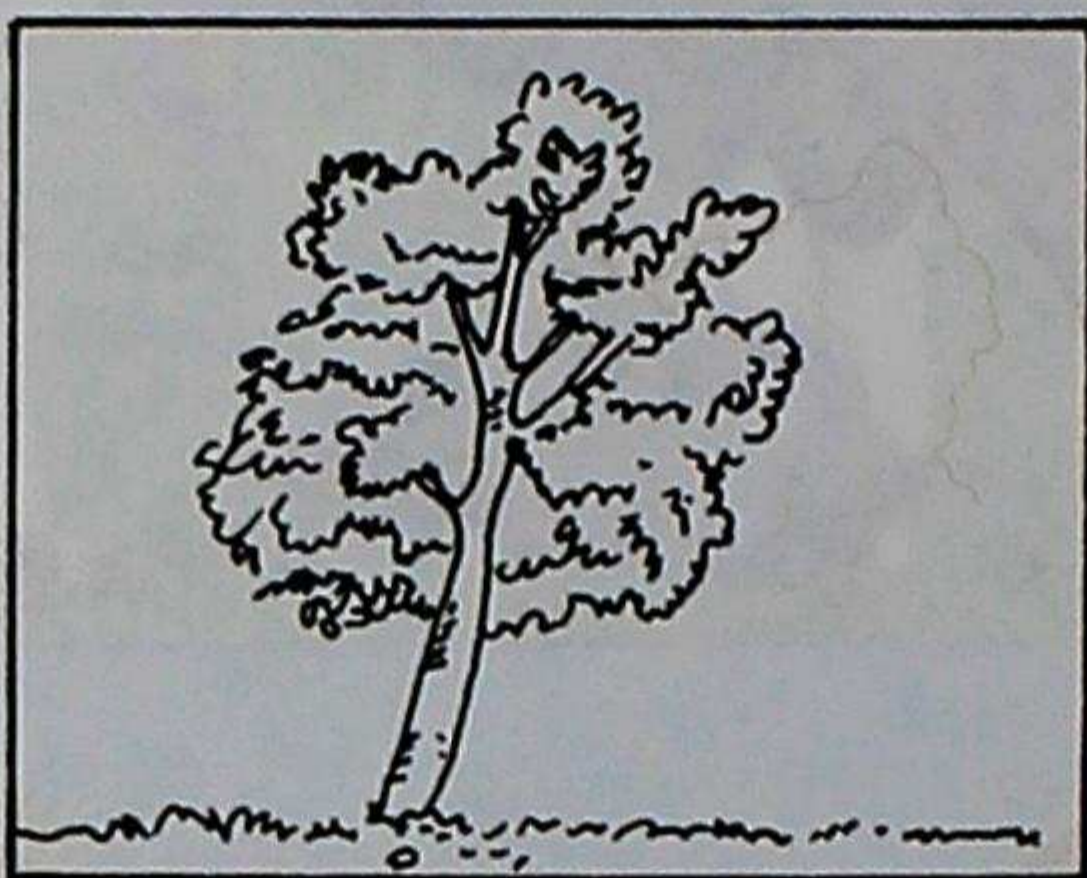

quishihuar

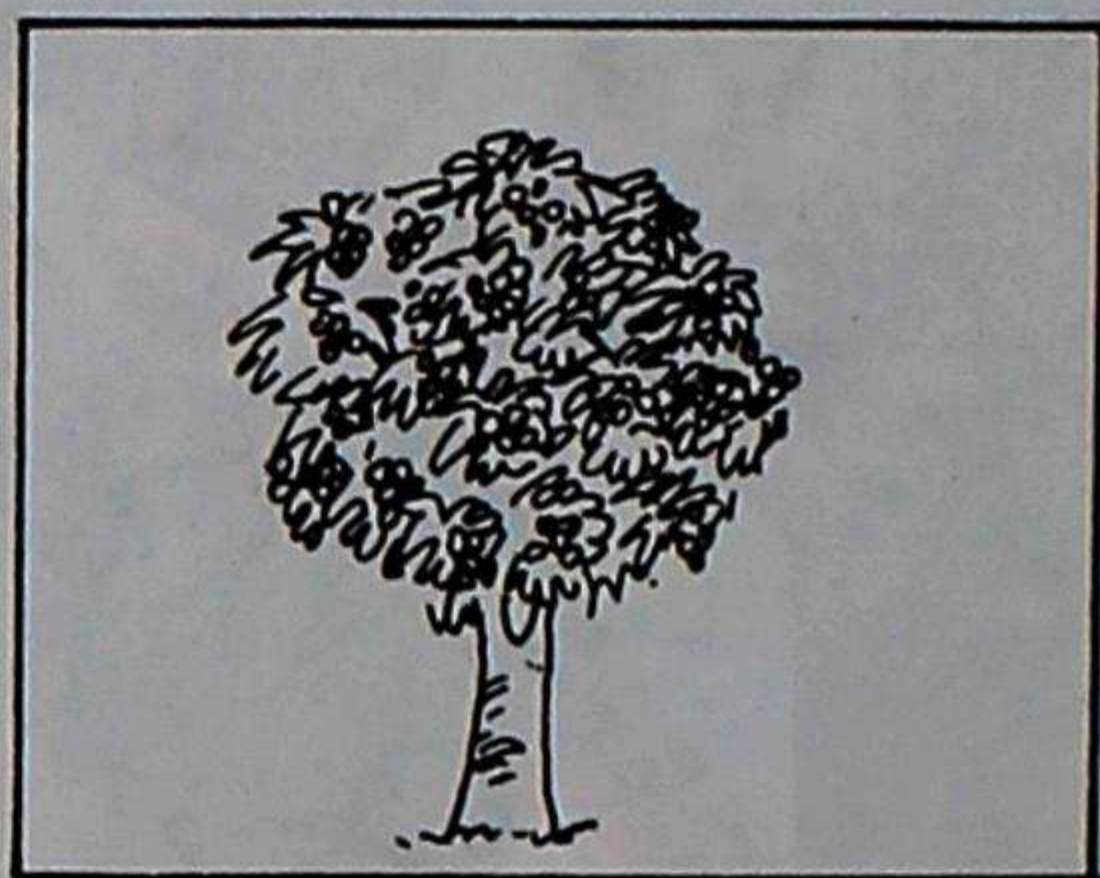

chulán

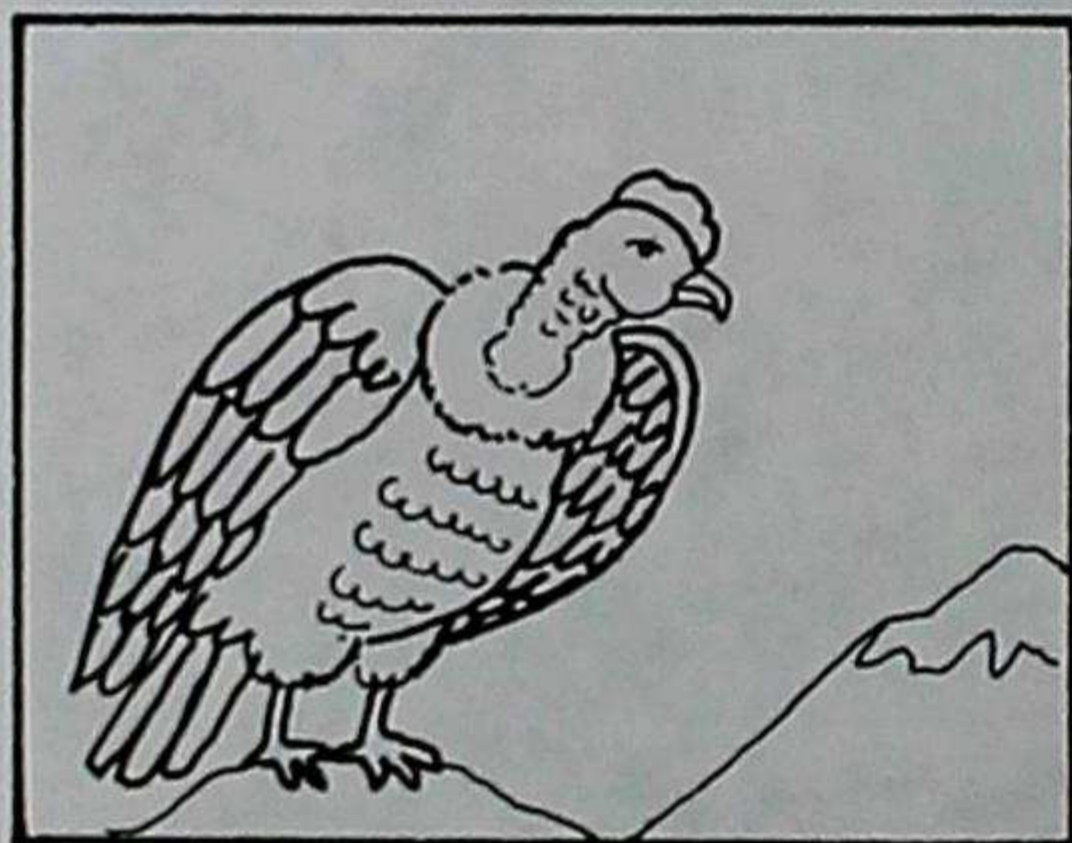

cuntur

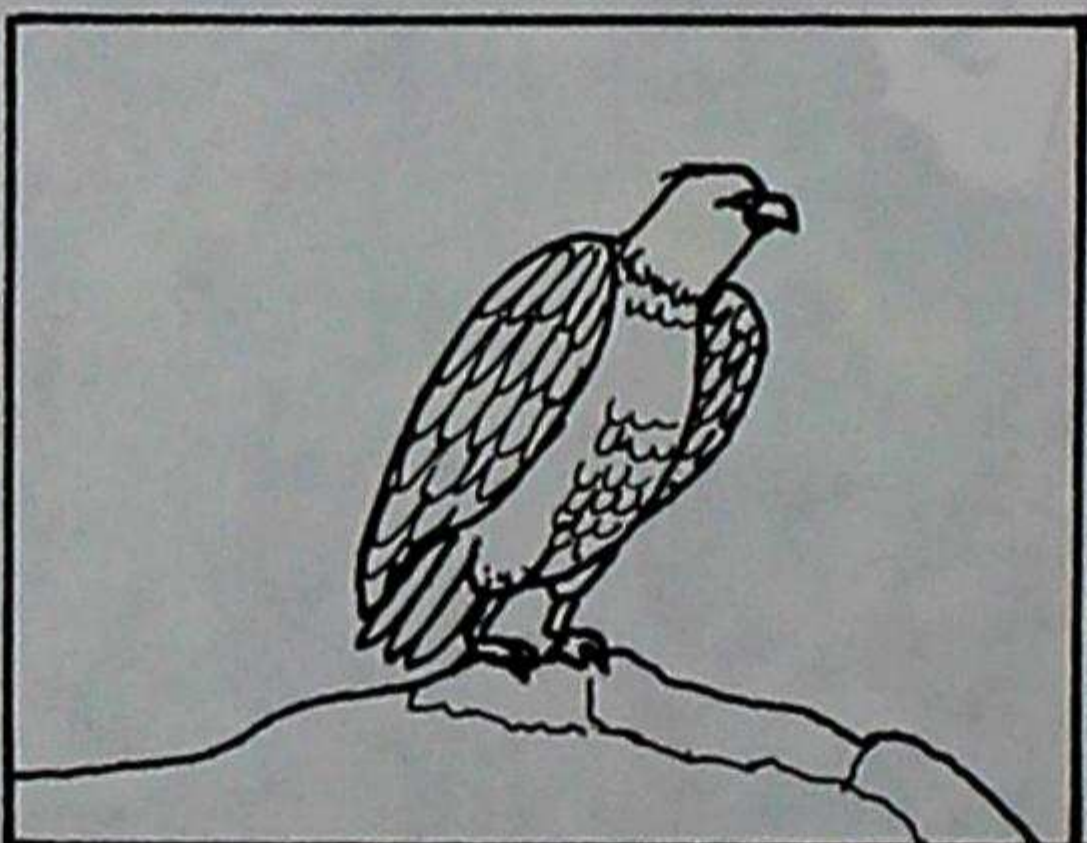

anca

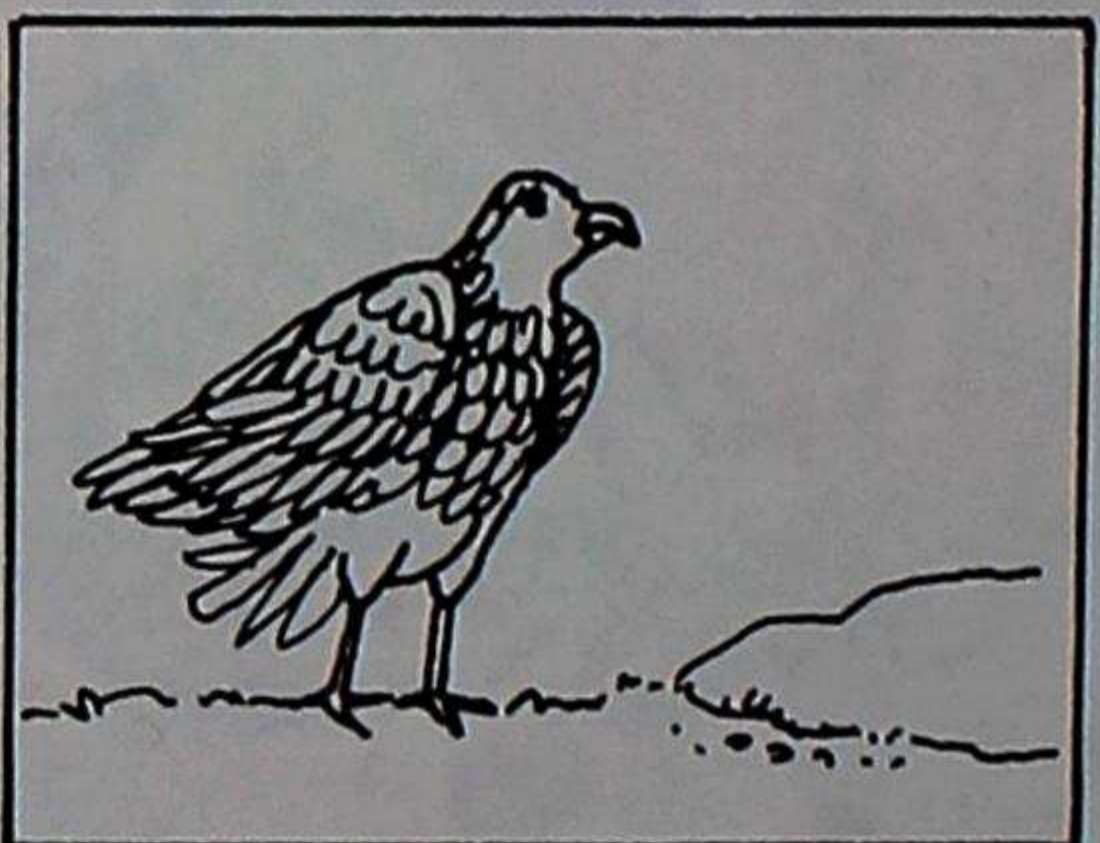

curiquinqui

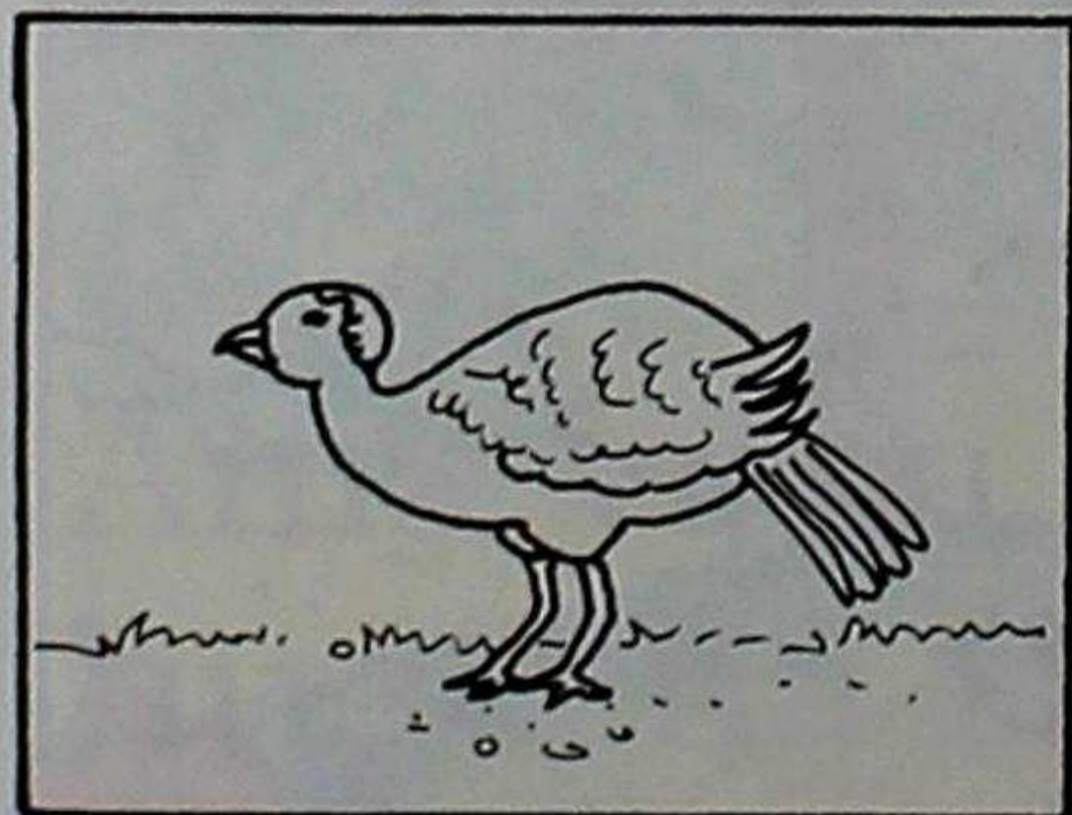

paushi

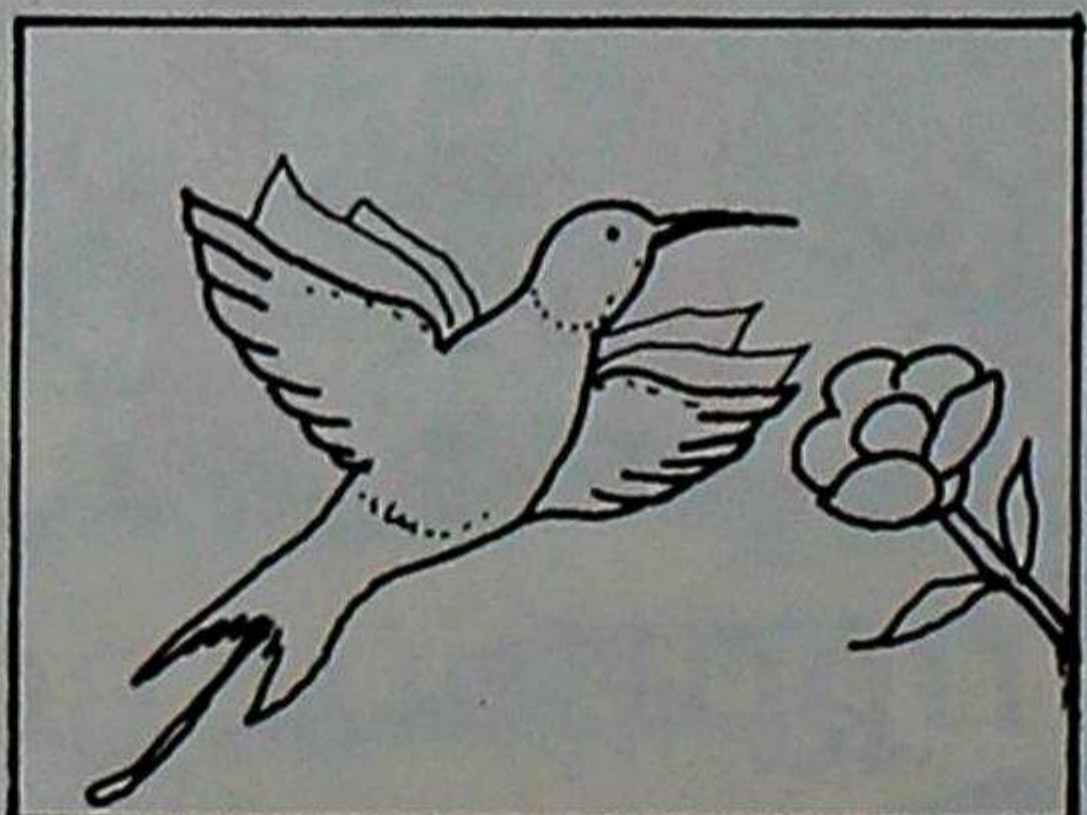

quinti

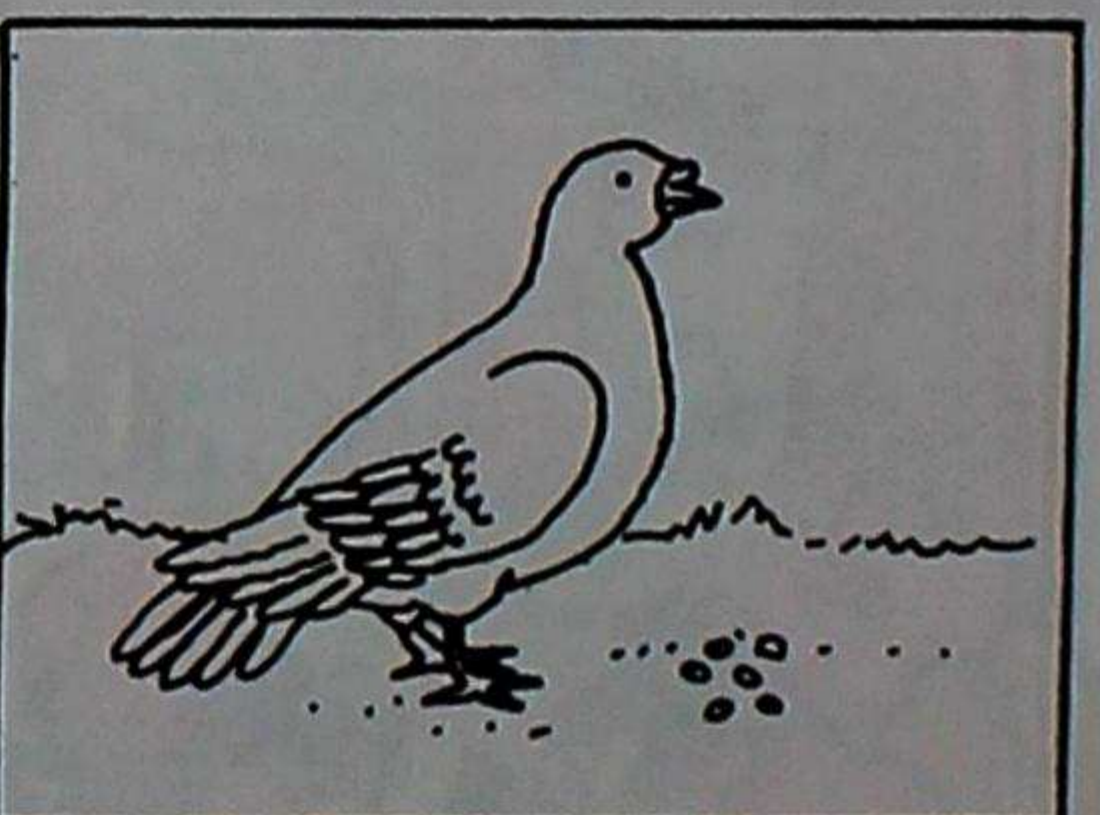

urpi

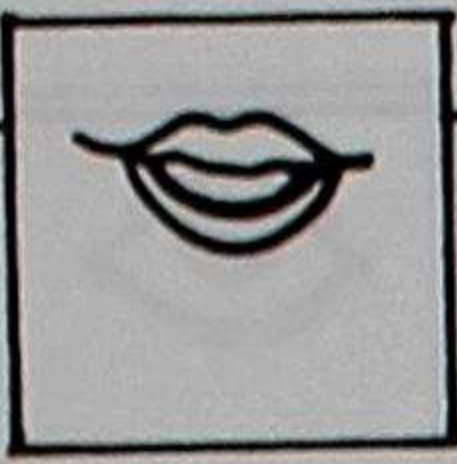

# Urcu yaya

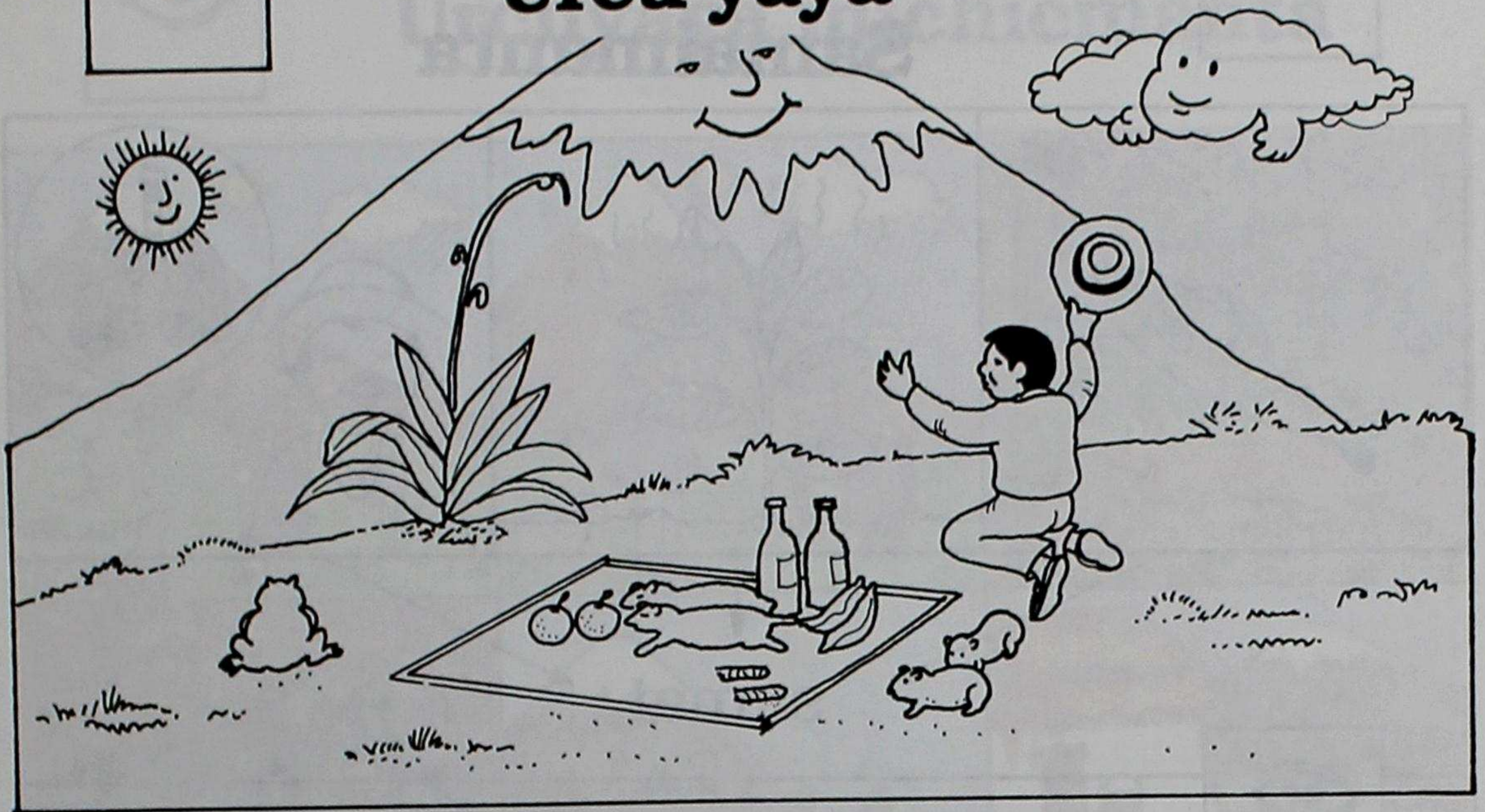

Ñucanchic urcu yayalla  
saracunaca chaquinmari,  
purutucunaca chincarinmari  
tamiachipayari.

Ñucanchic puyu mamalla  
yacuca illanmari  
imahuantac tarpushun  
sumac mamalla tamiachipayari.

Ñucanchic tamia mamalla  
huhuacuna yaricachincamari  
murucuna pucuchunca  
tamiachipayari.

Ñucanchic urcu yayalla  
cai sumac caraita chasquipai  
quiquinmari ricunqui  
cai huaccha churicunataca.



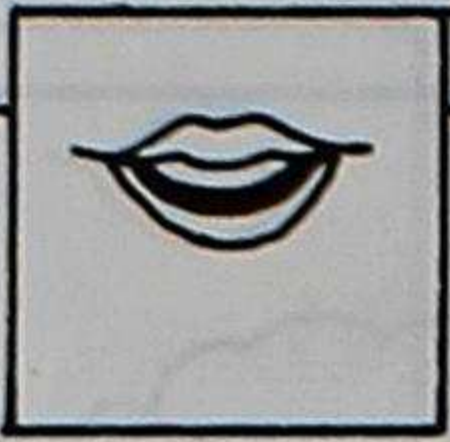

# Samaimanta

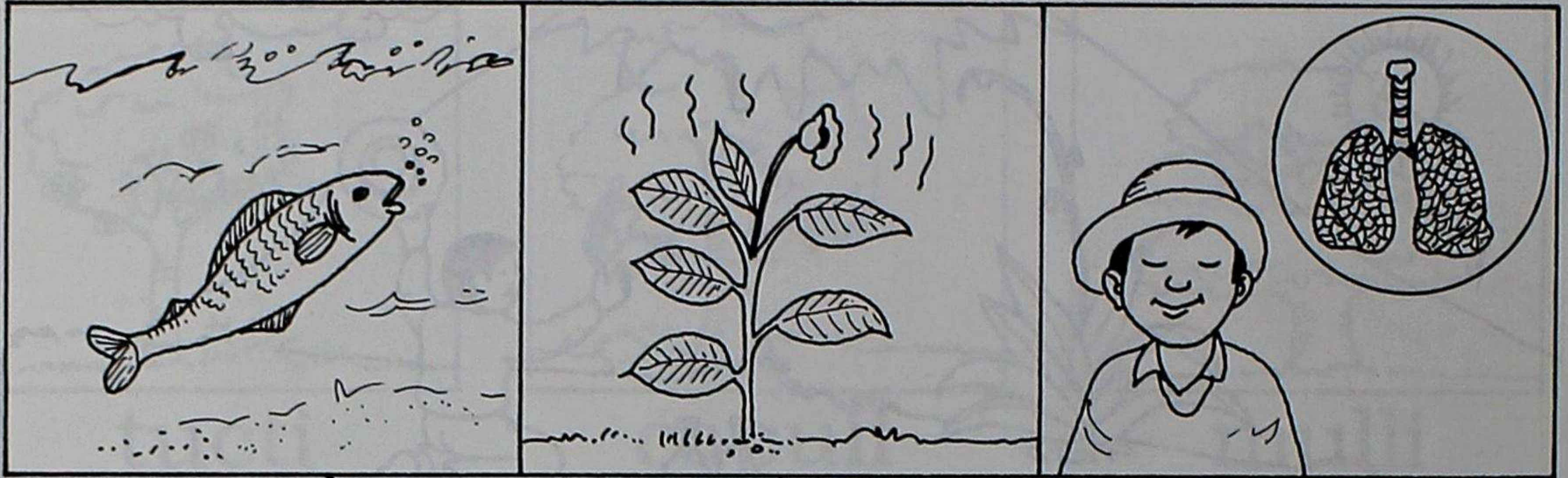

samai

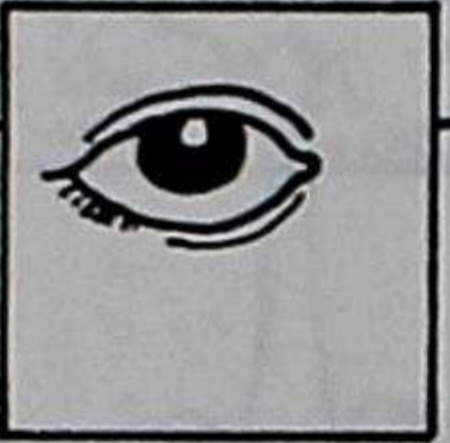

# Allichinamanta

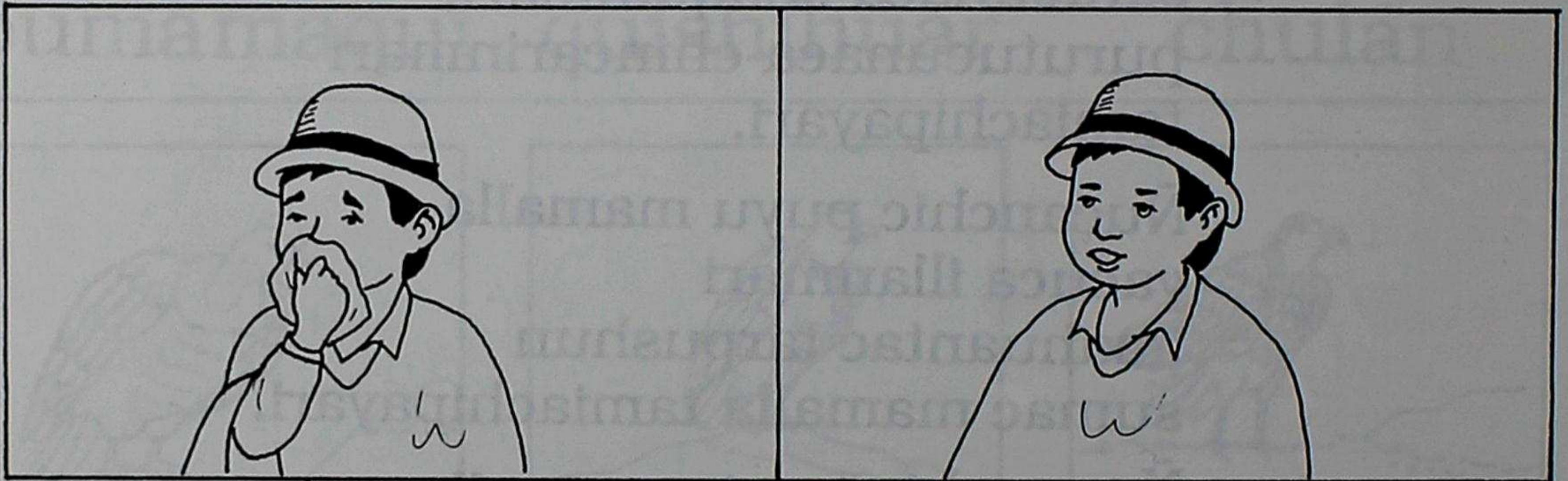

# Pintumanta

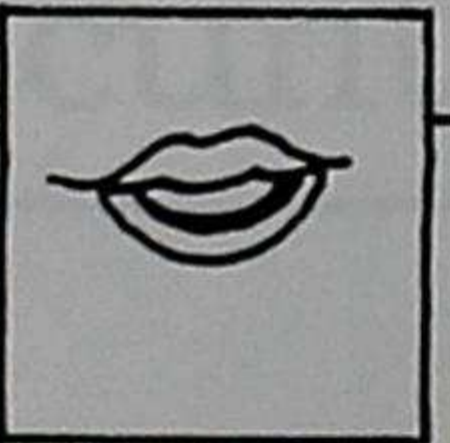

pintu



# Urcuyaya michicmanta

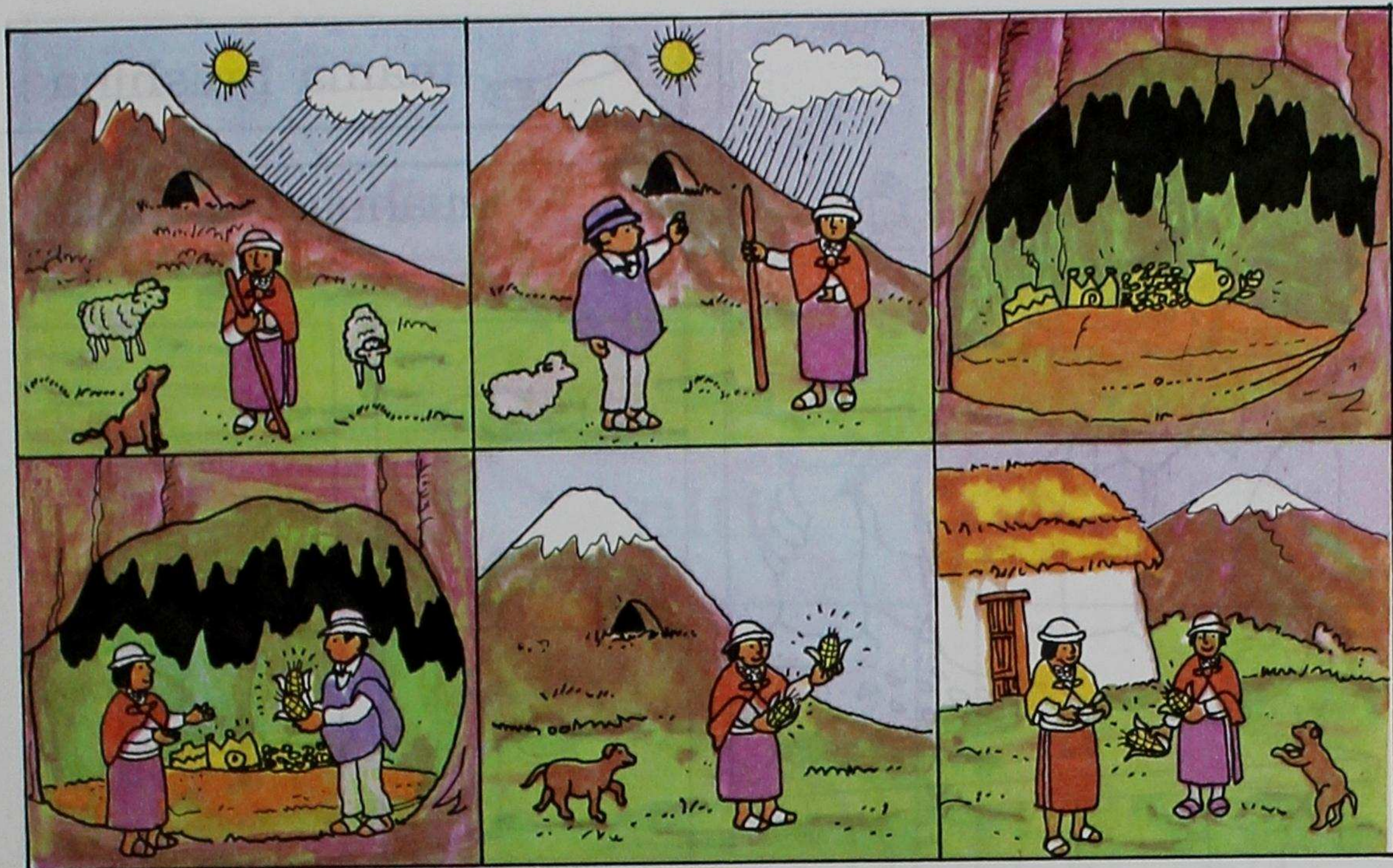

Huarmica urcupi intihuan tamiacucpimi  
llamacunata michicushca.

Chaipimi urcu yayaca huarmipacpi ricurishca.

Urcuyayaca:- "Jacu machaiman huarmicu"  
nishpami pushshaca.

Machapi urca yayaca ishcai curi saratami  
huarmimanca carashca.

Quipamanca taita, mamata yuyashpa,  
ticramunayachispami ishcai curi sarahuan  
llucshishca.

Cai huarmica huasiman chayashpaca  
sumactami causashca.

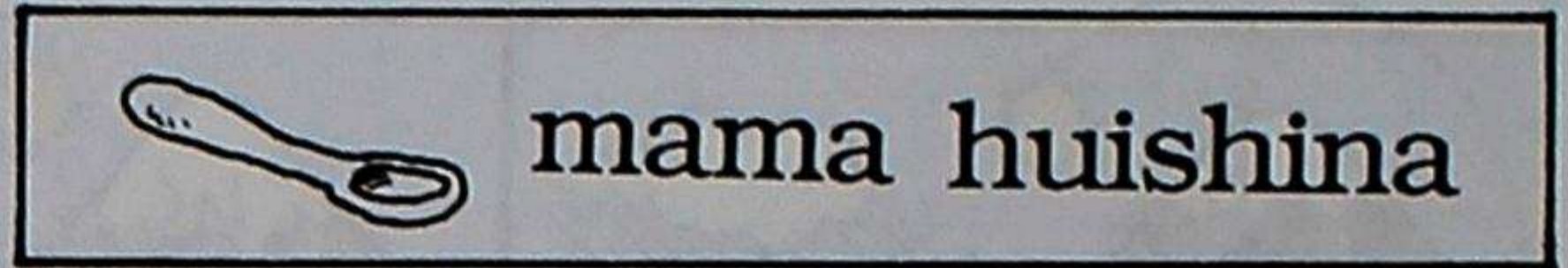
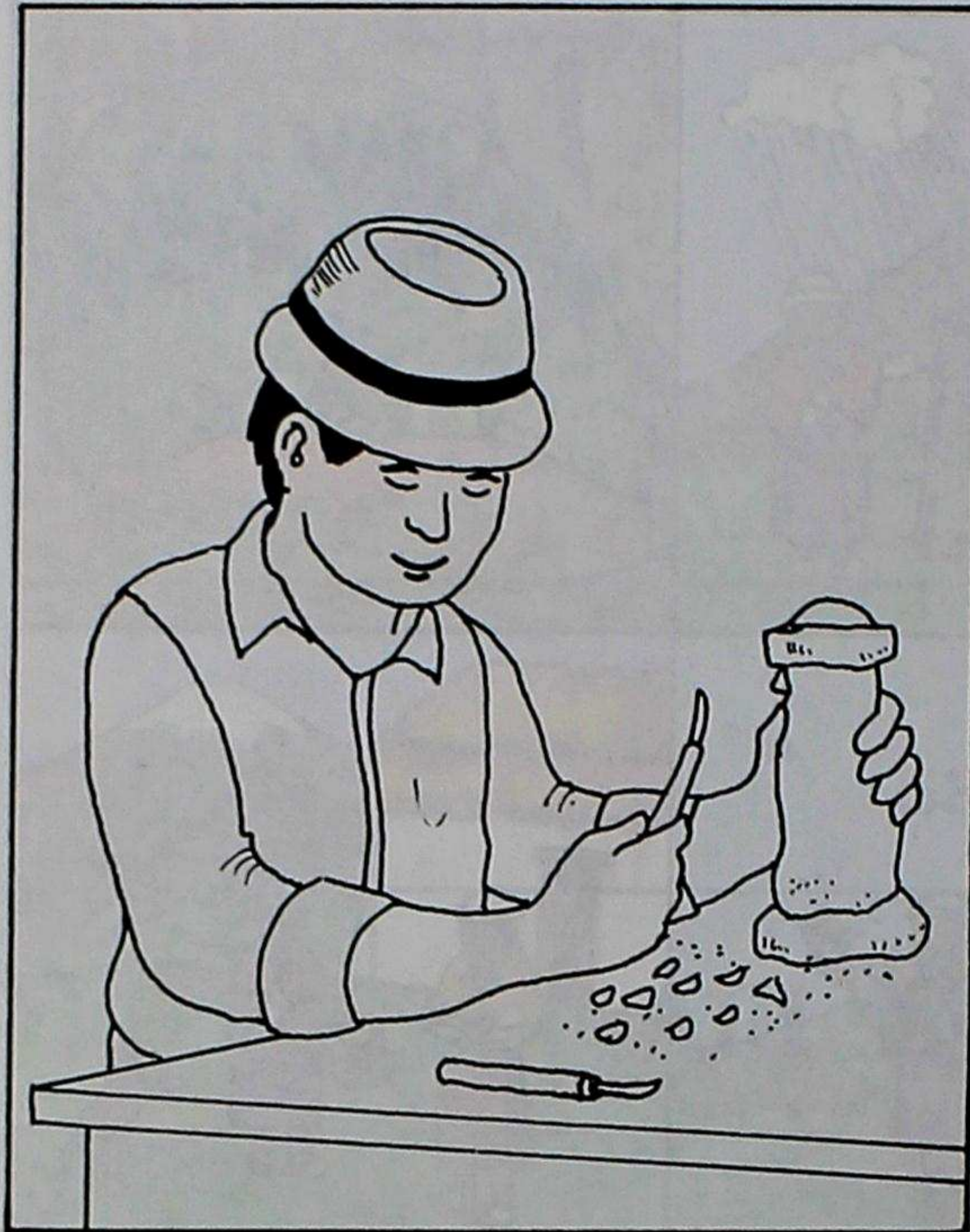
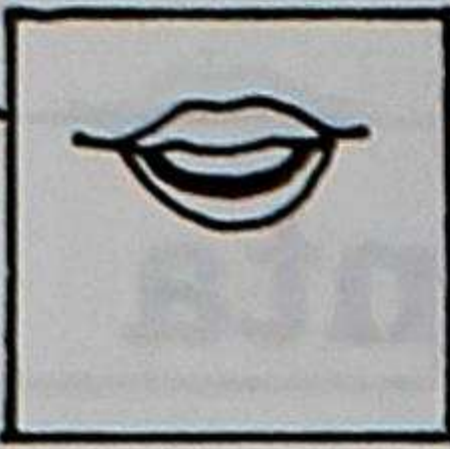

mama huishina

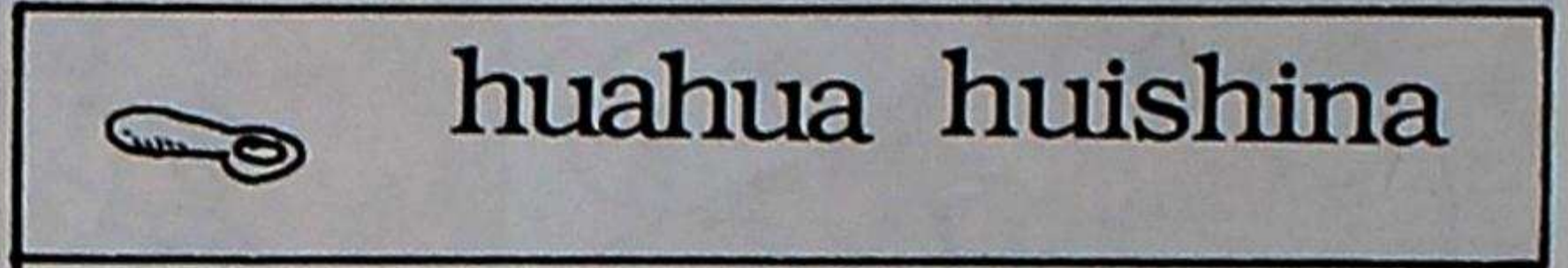

huahua huishina

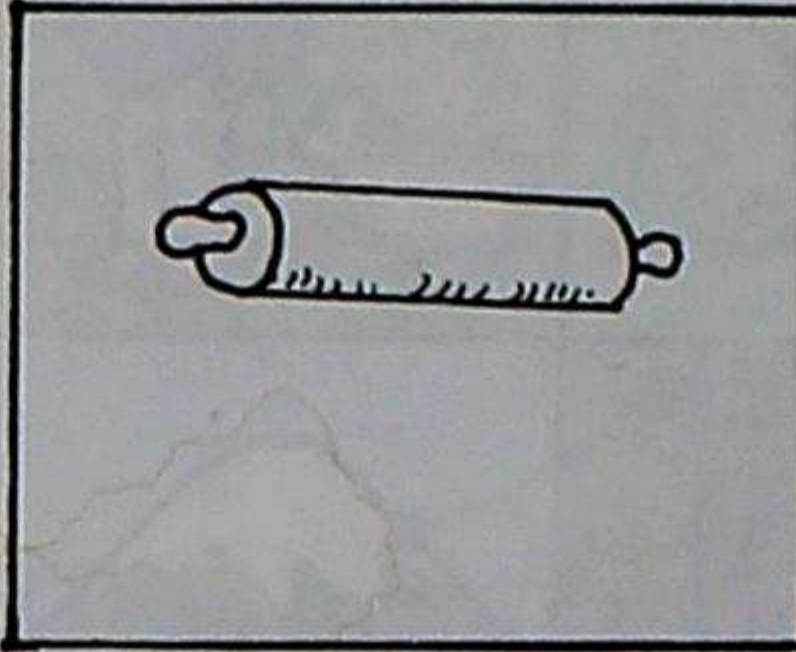

llapichina

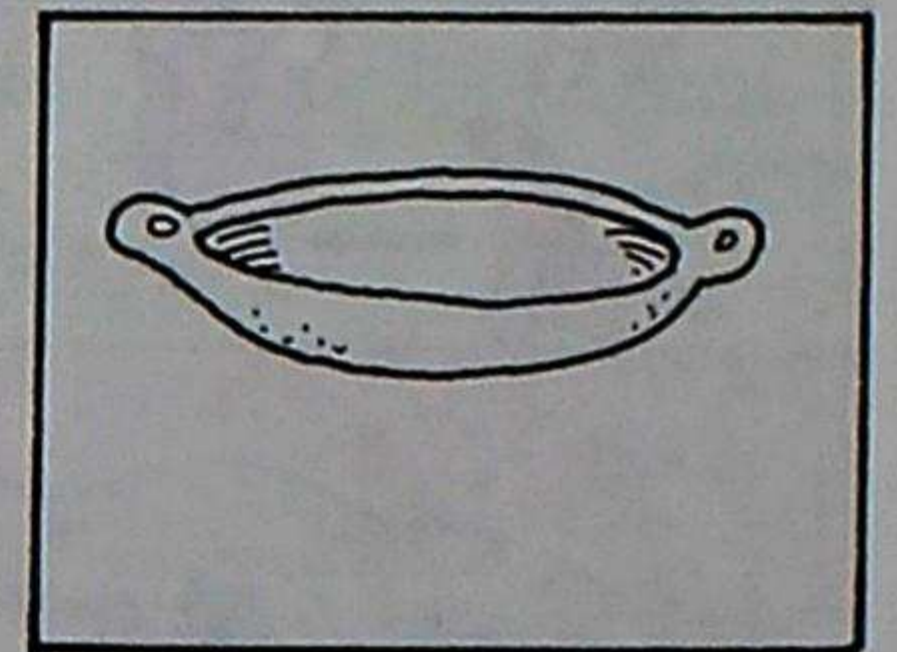

batea

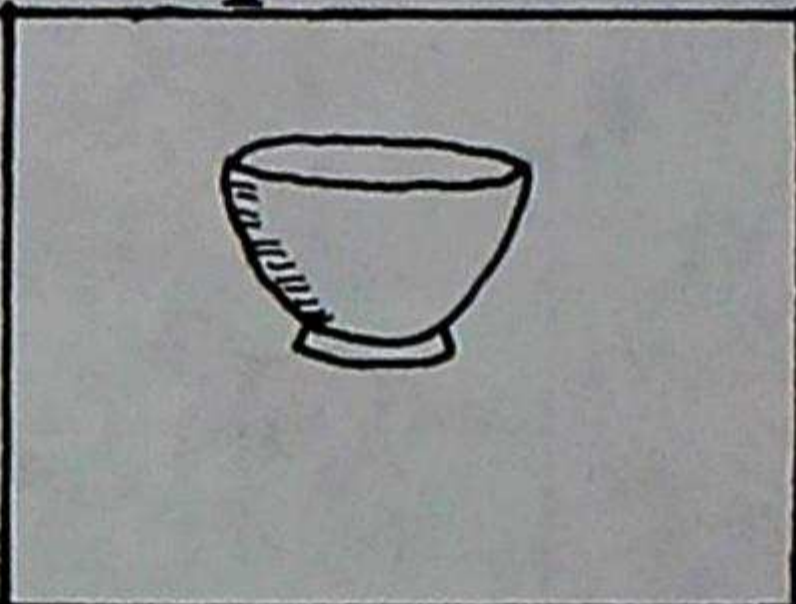

pucu

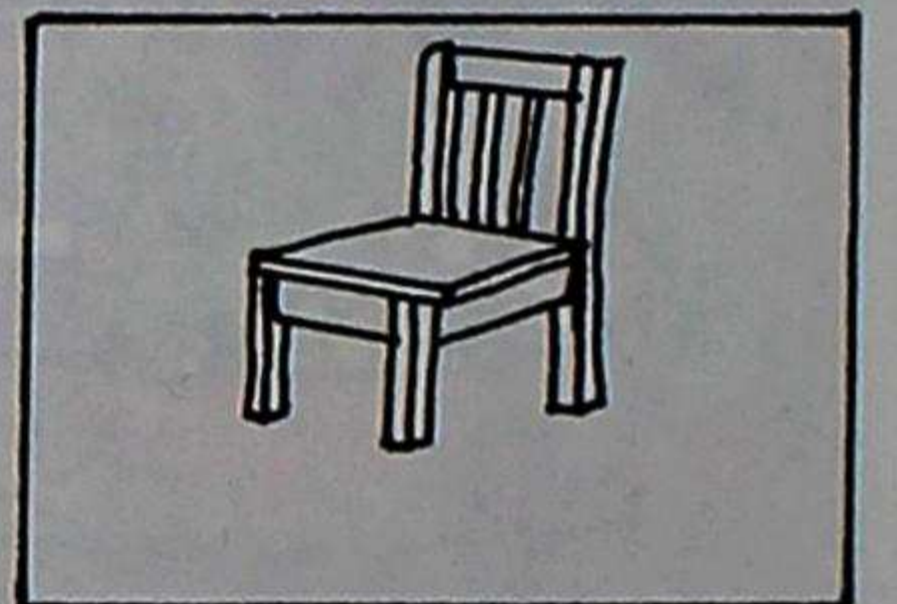

tiarina

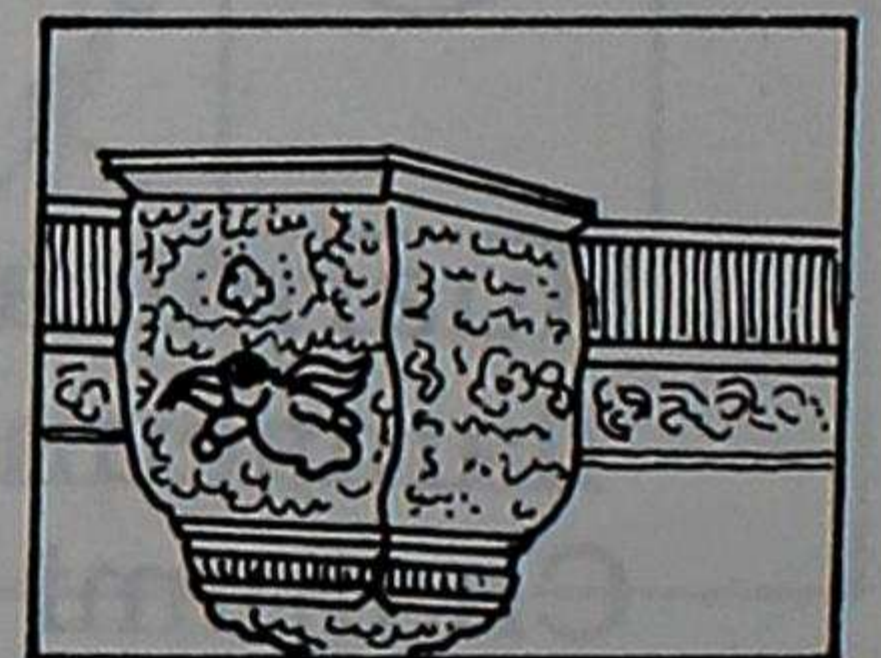
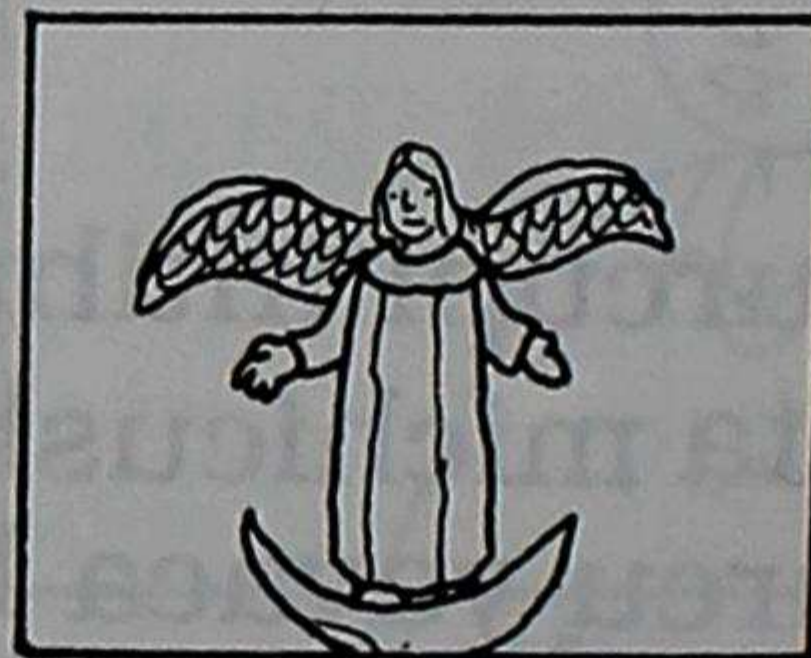
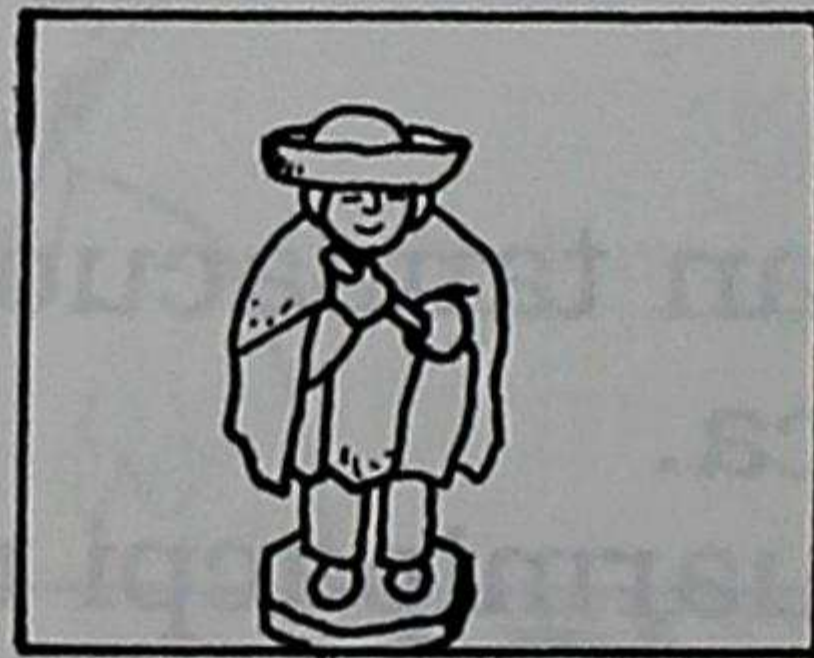
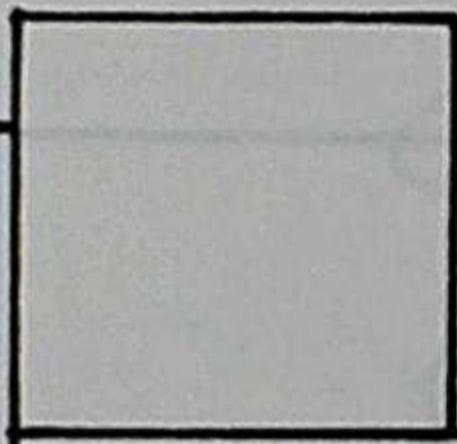

## Caspihuan sumac rurashca

Cai caspicunahuanca sumactami maquihuan llancancuna. Caspicunahuanca: mamahuishina, huahua huishina, pucu tiarina shuccunatapashmi ruran.

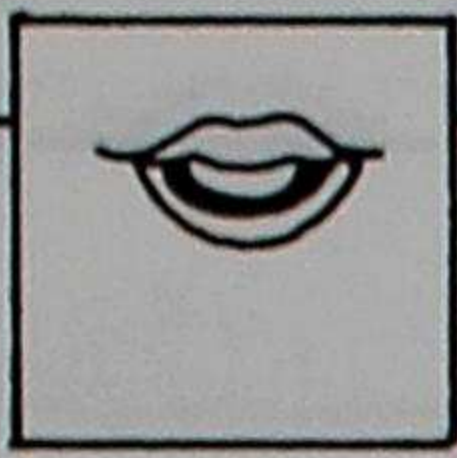

# Tupucunamanta

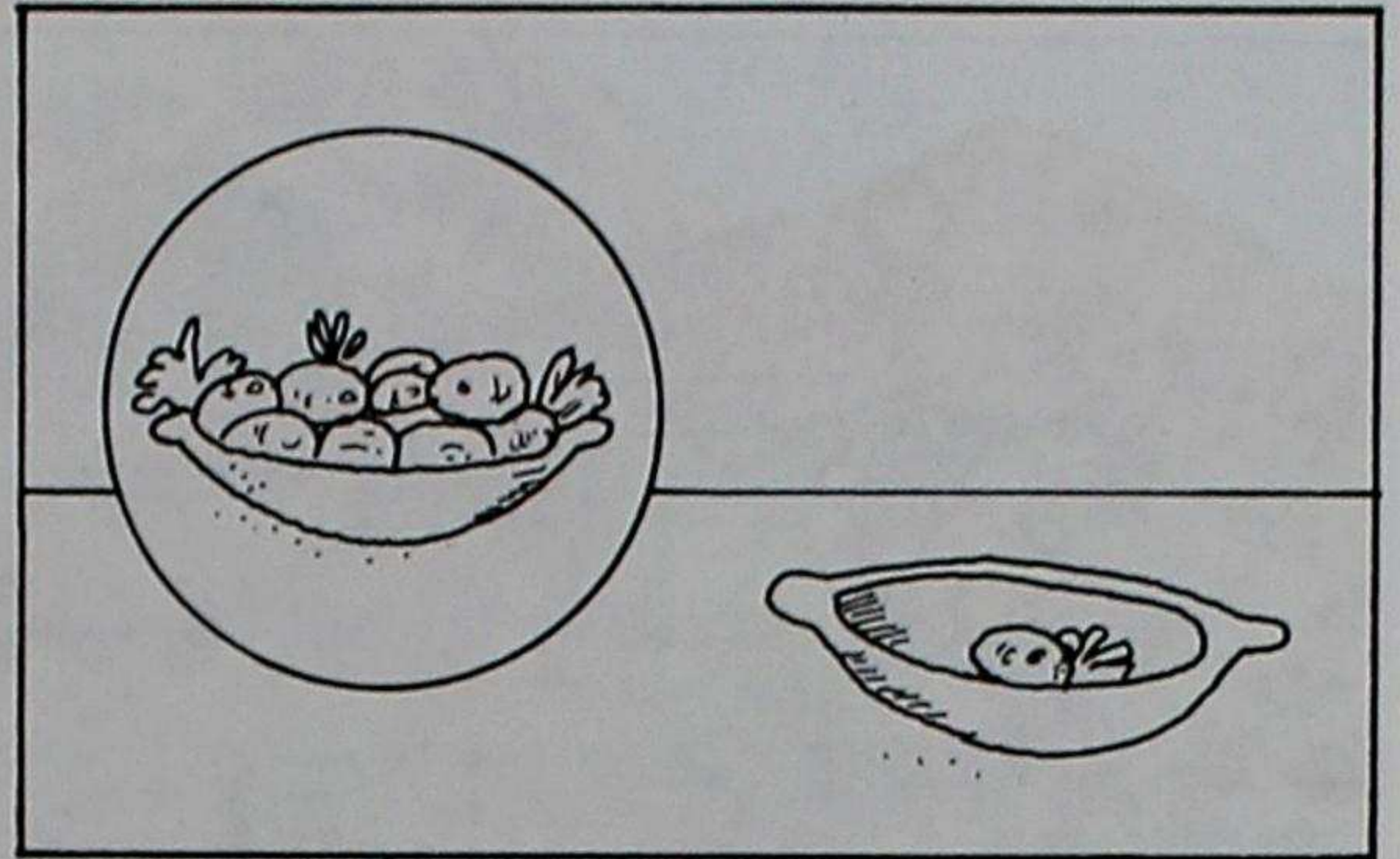
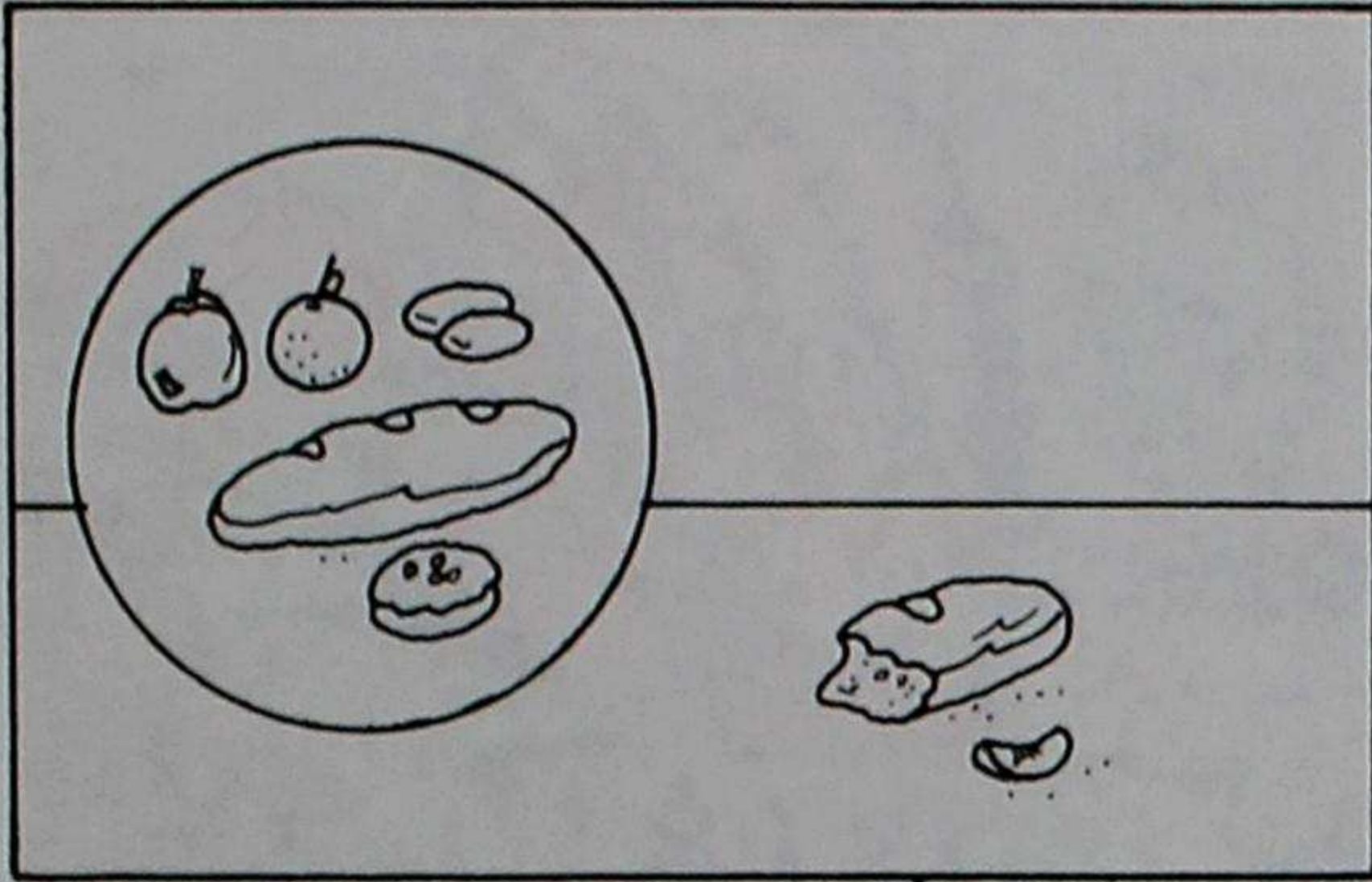

piti

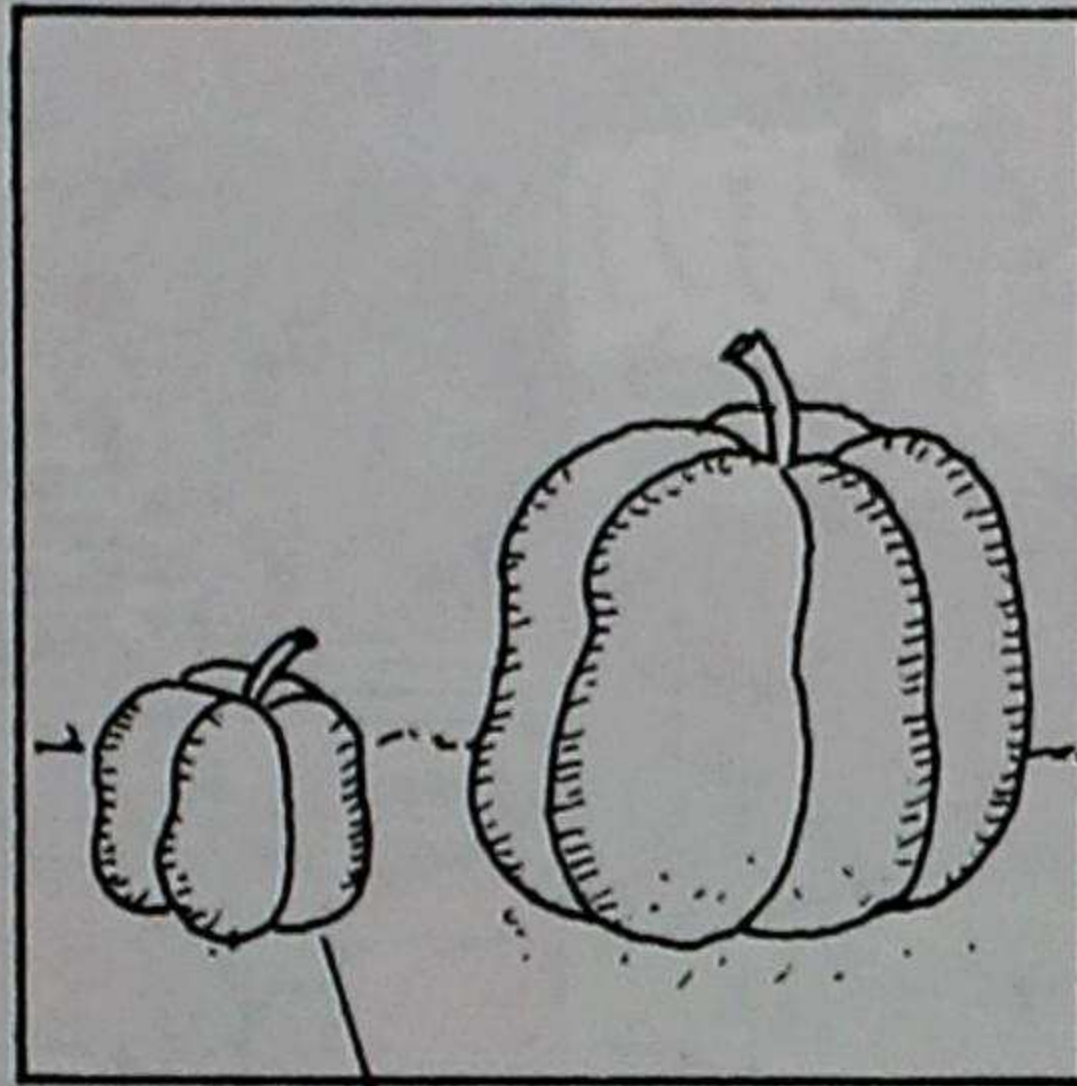
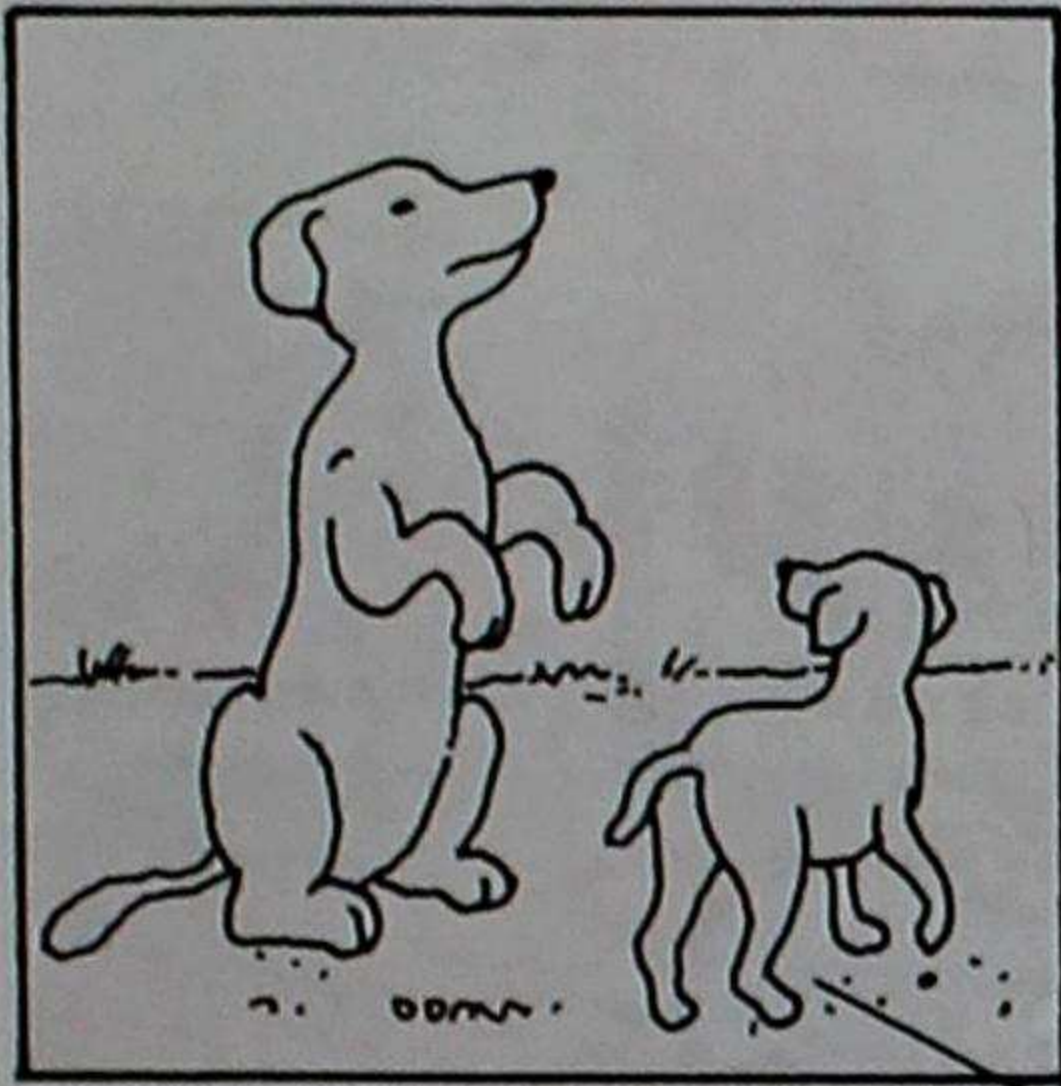

chuzu

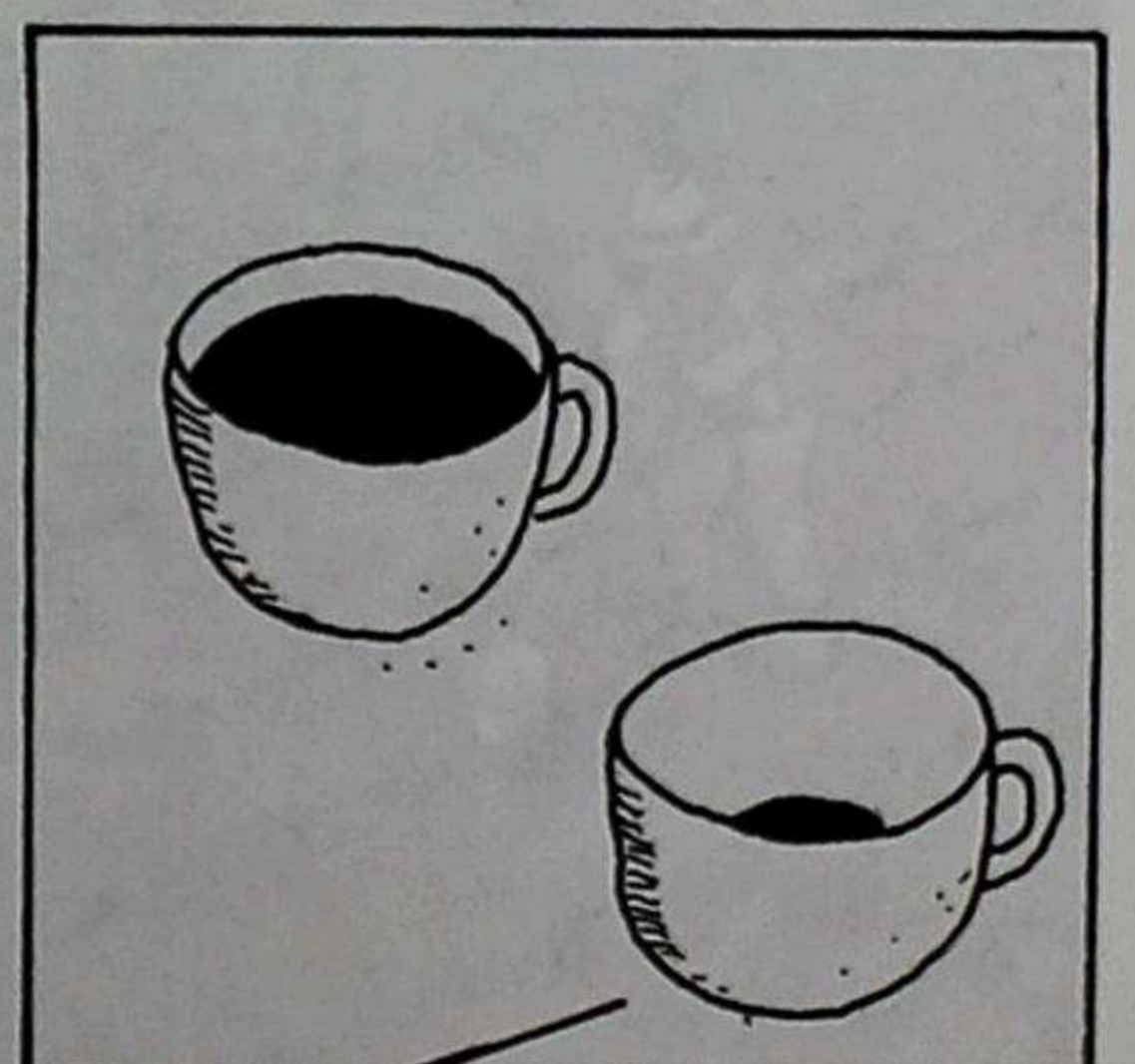
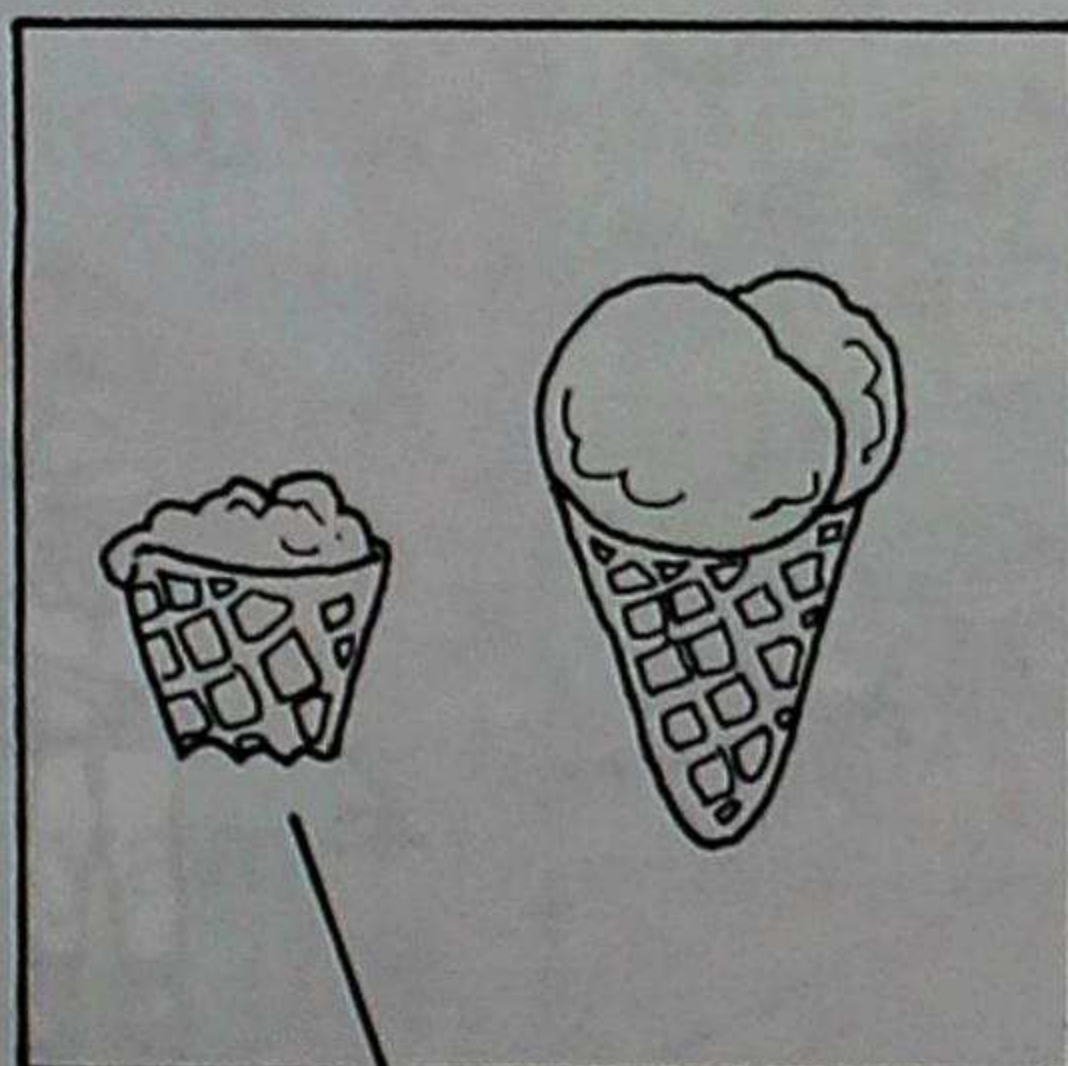
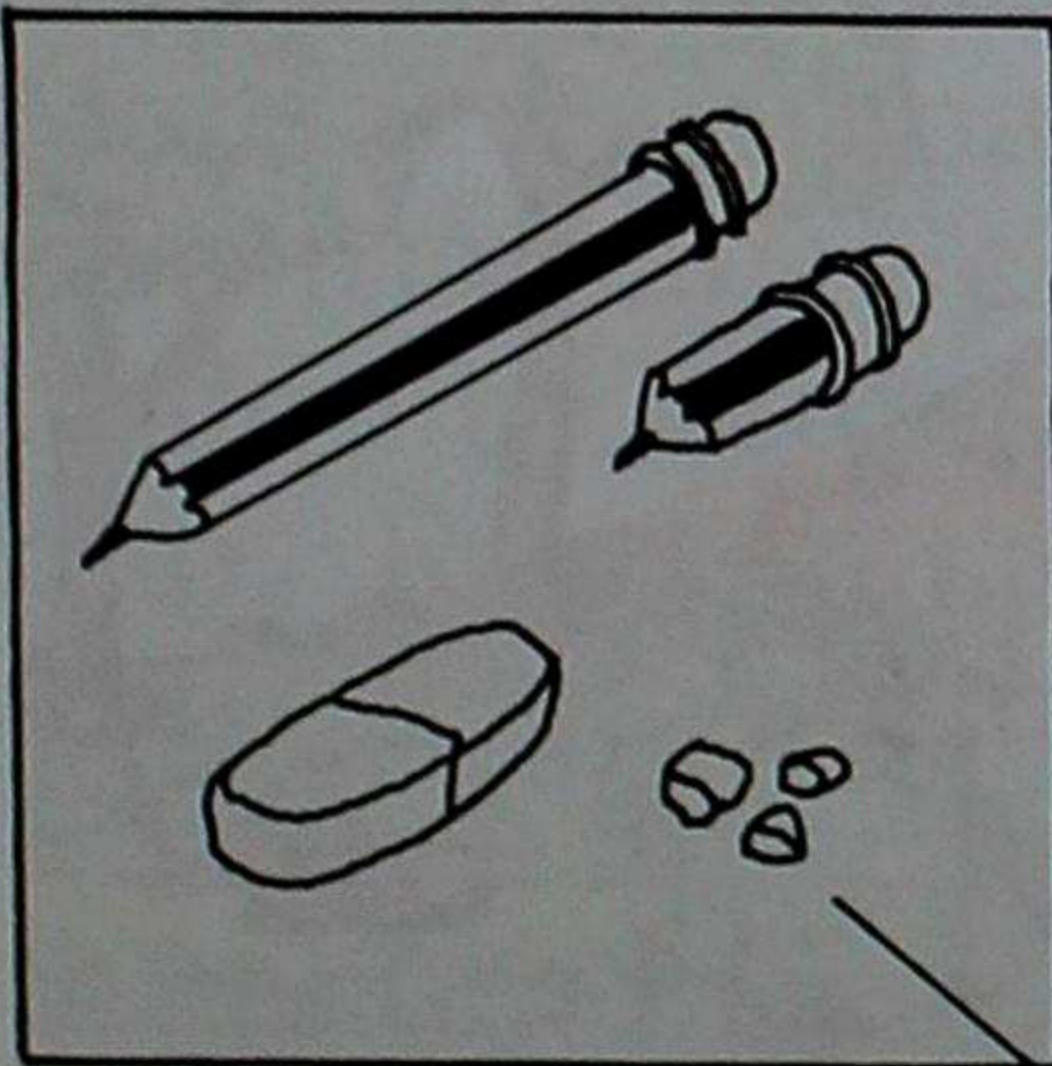

puchu



Toponimata

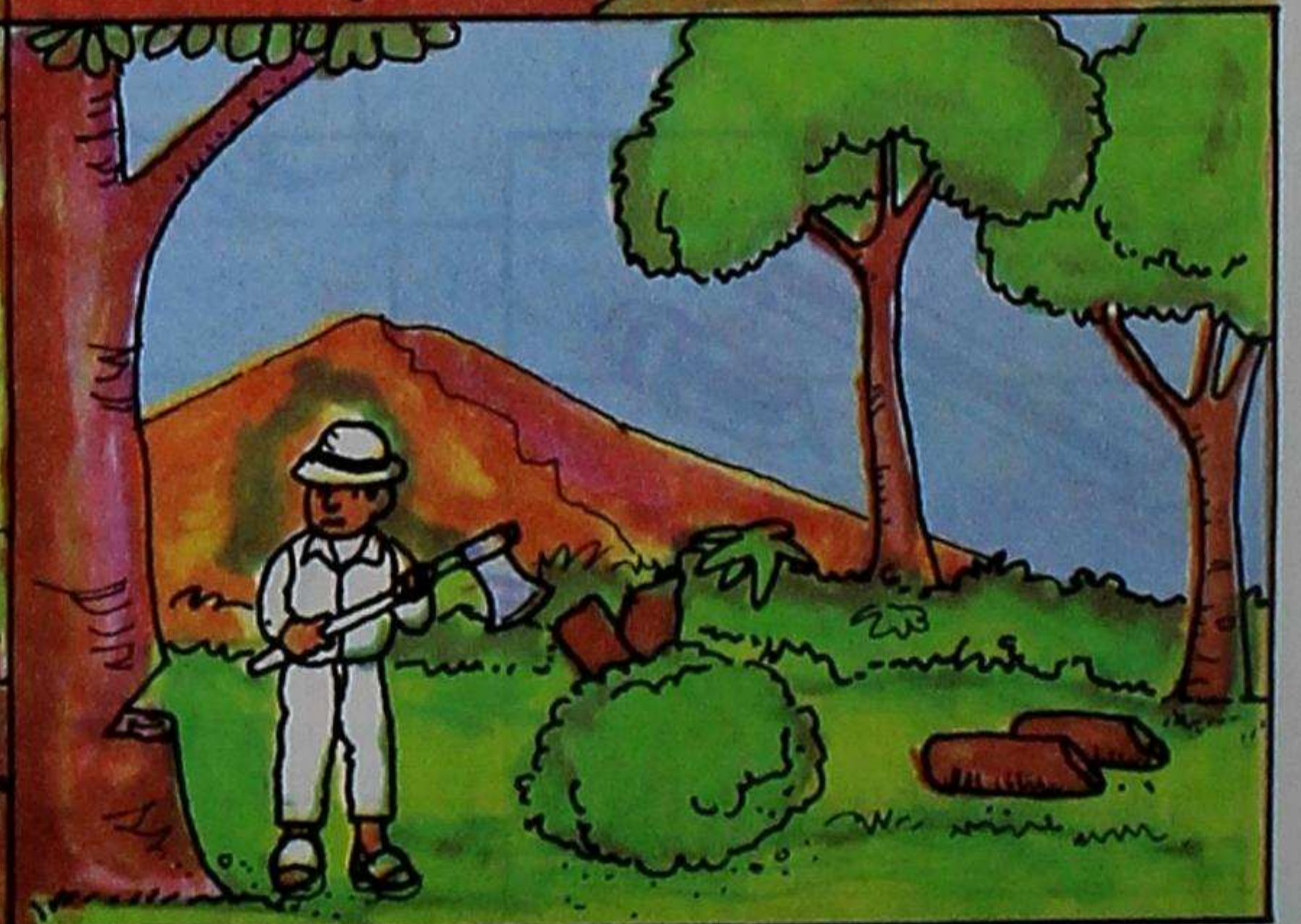
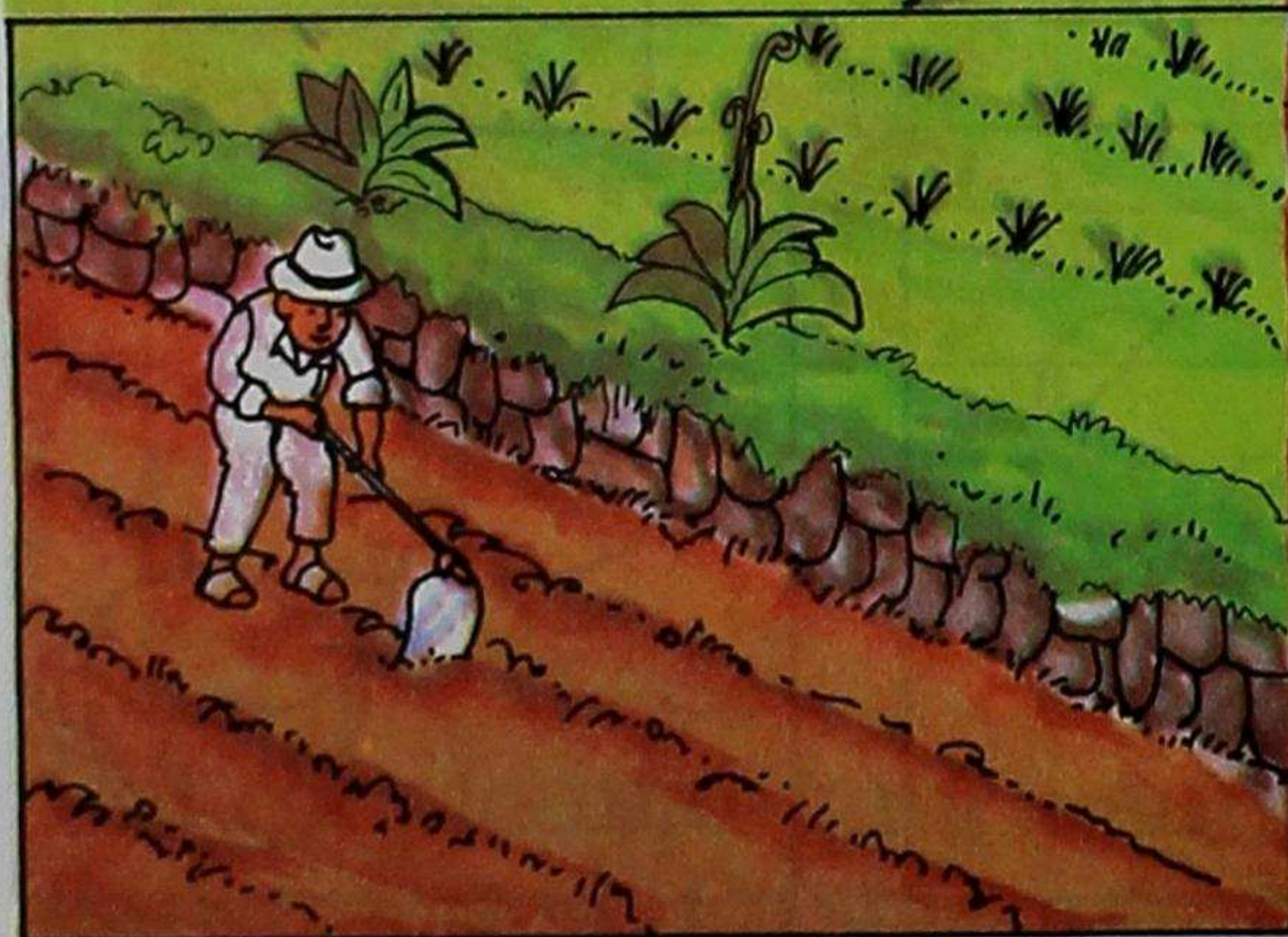
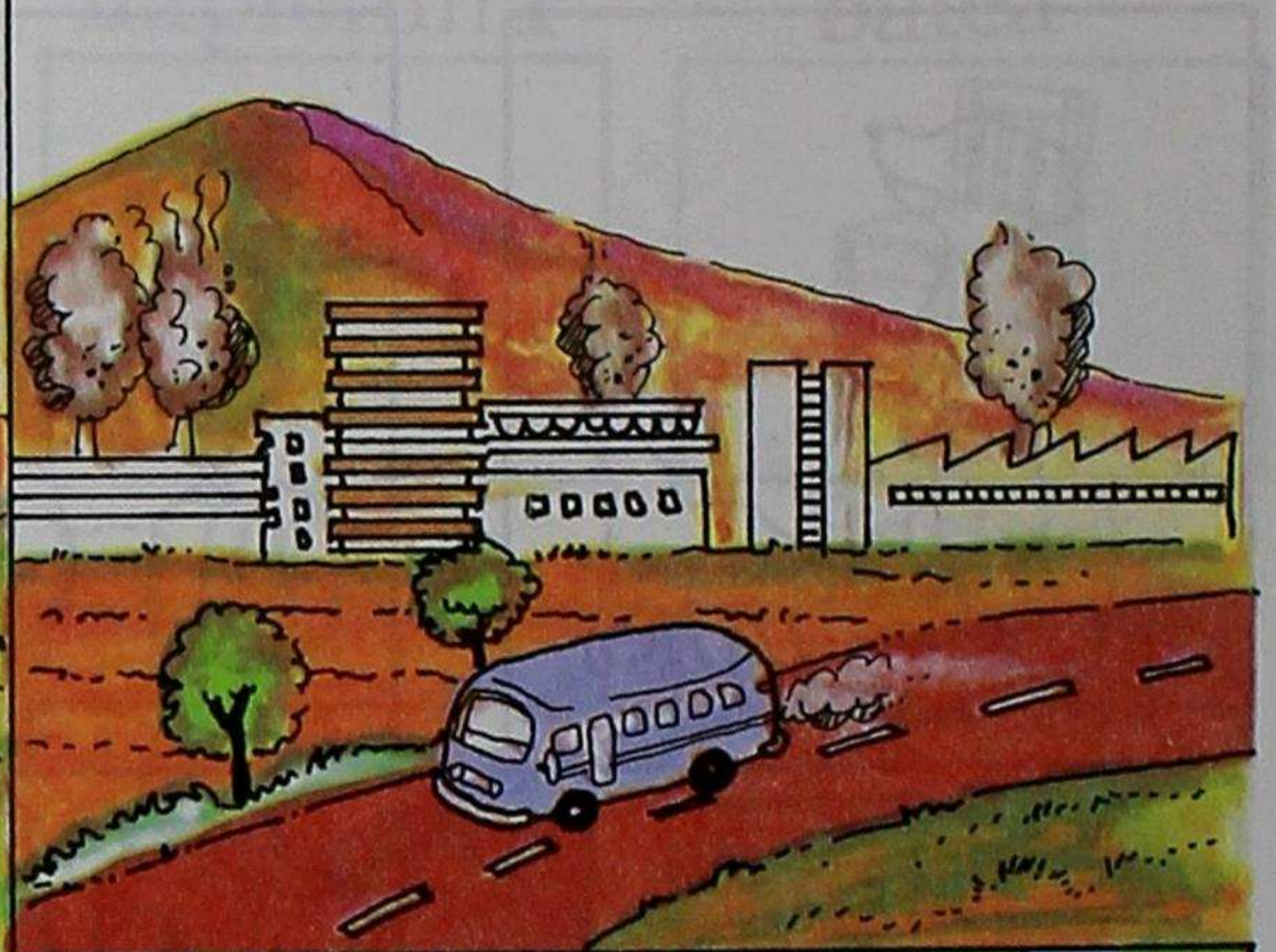
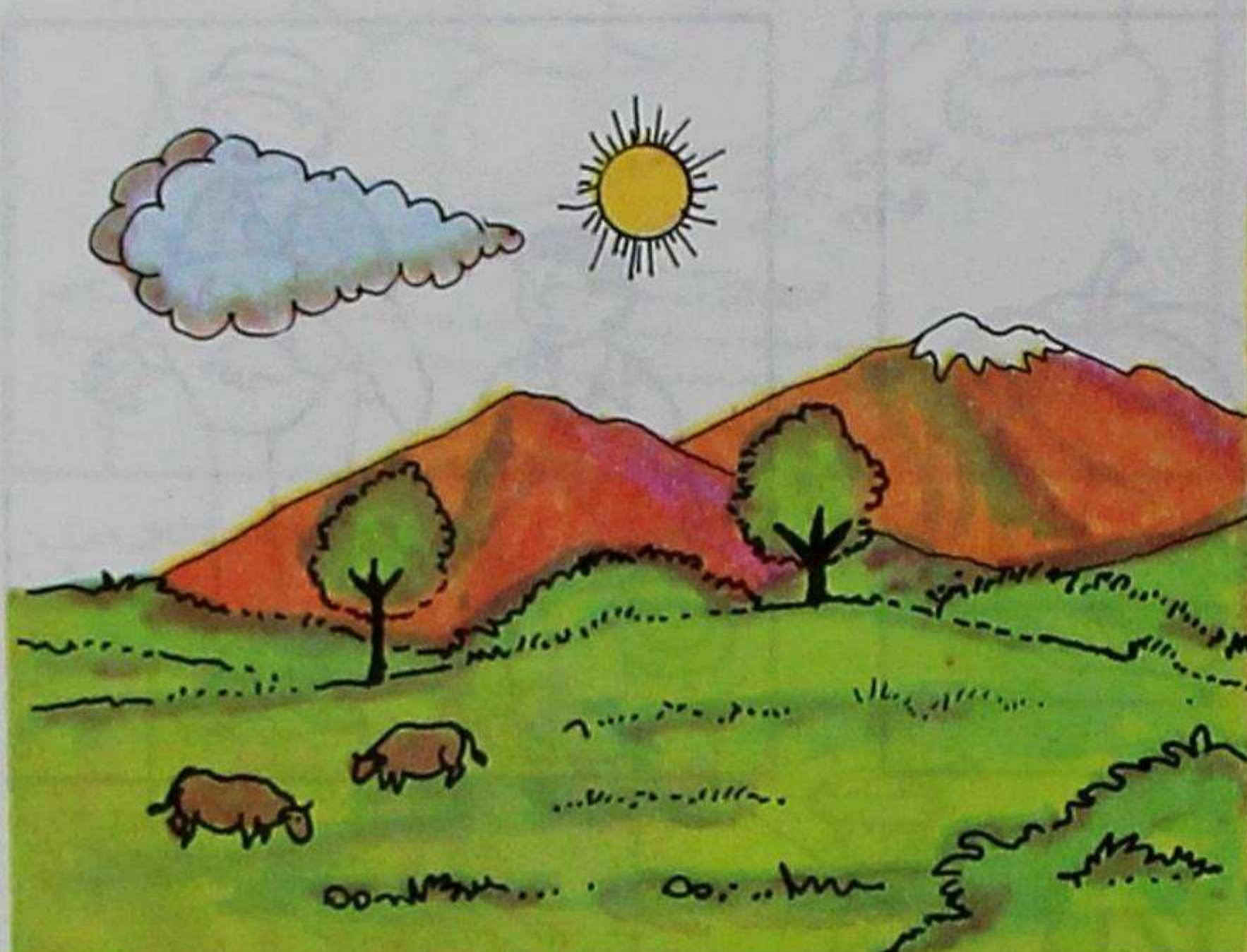
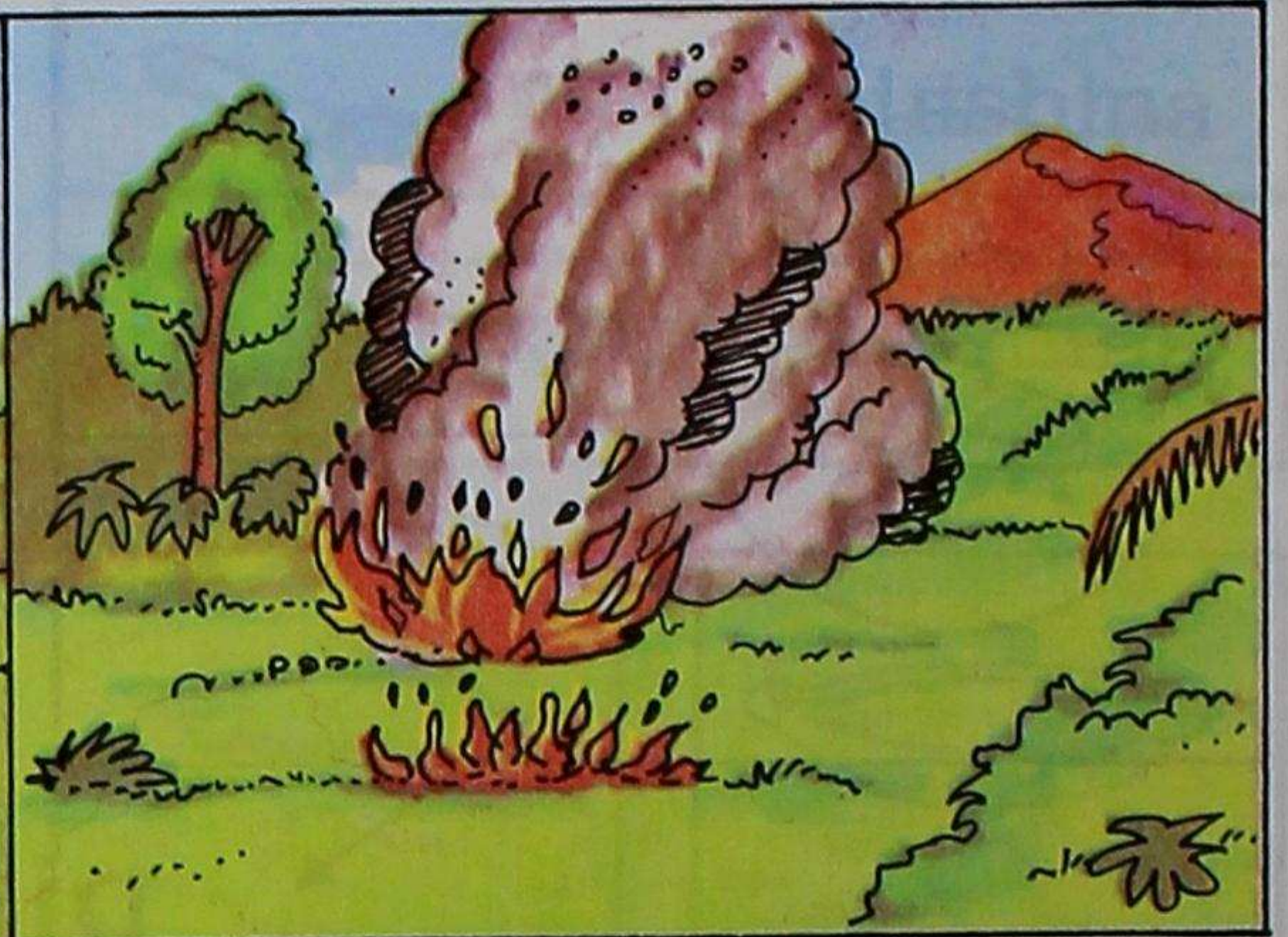
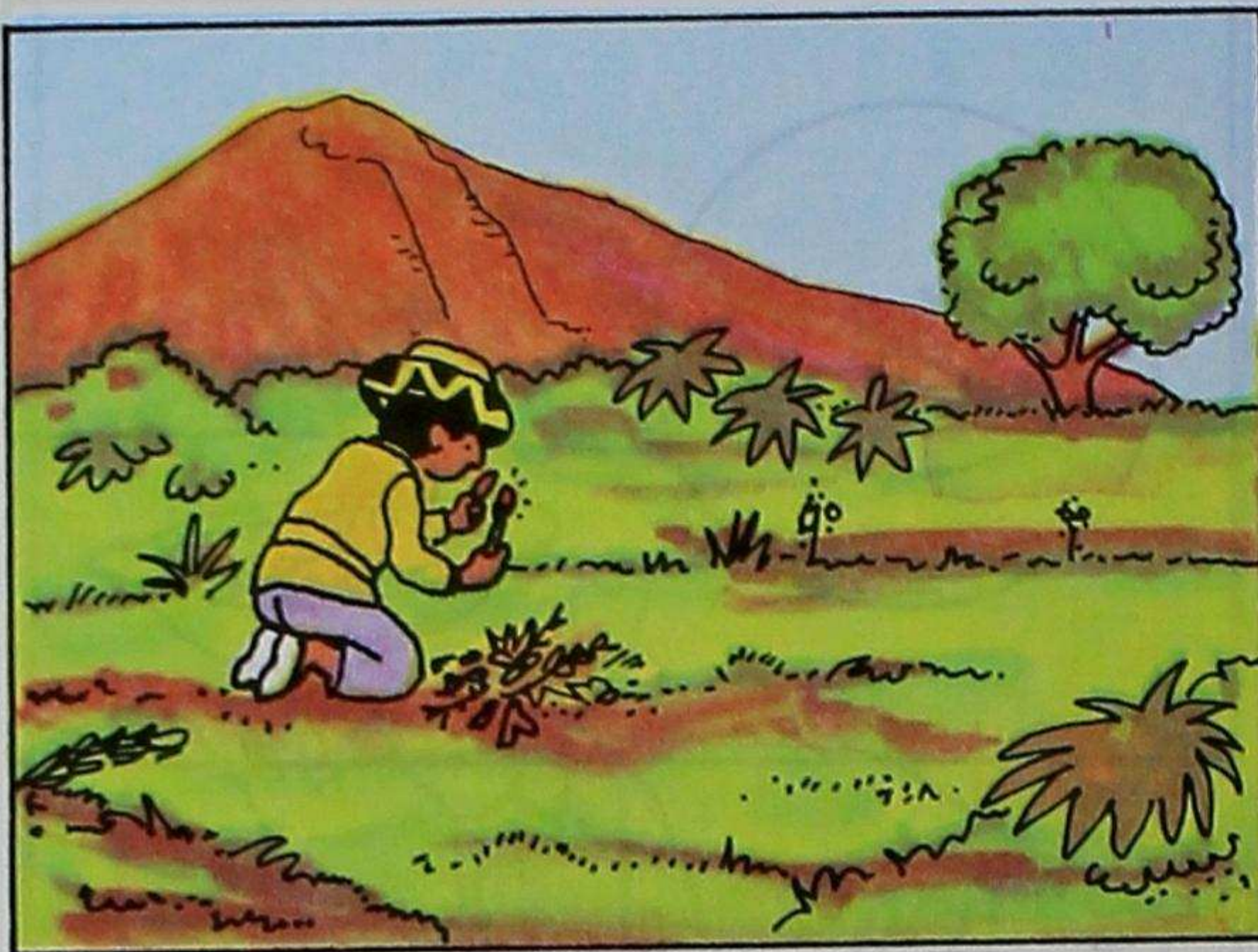
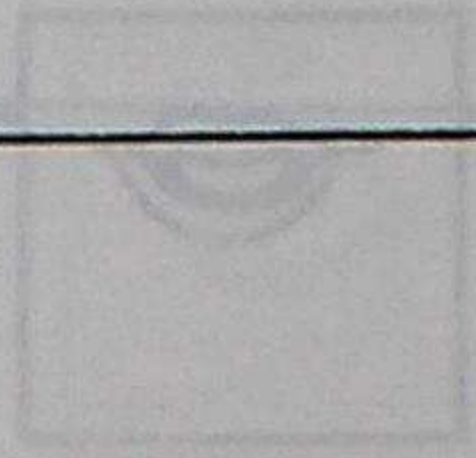

Ñucanchic pachata quishpichishunchic.



# Huahuamanta



Marcac yaya mamacunaca paicunapac  
marcashca huahua alli causaita charichunca  
cunashpami huiñachic.

Marcac yaya mamacunaca paipac marcashca  
huahuamanca churanata, huihuacunata,  
cullquita, shuctac sumac camaricunatapashmi  
cun. Ranti, marcashca huahuapac yayacunaca  
marcac yayamanca alli micunacunatami caran.  
Shinami marcac yayacuna, huahuapac  
taitacunahuan sumacta mashiyarishpami  
causancuna.

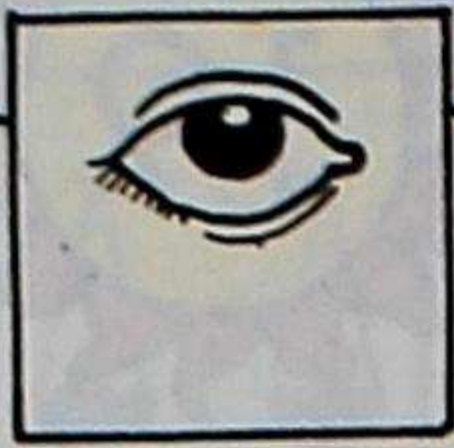

# Huachachic mamamanta

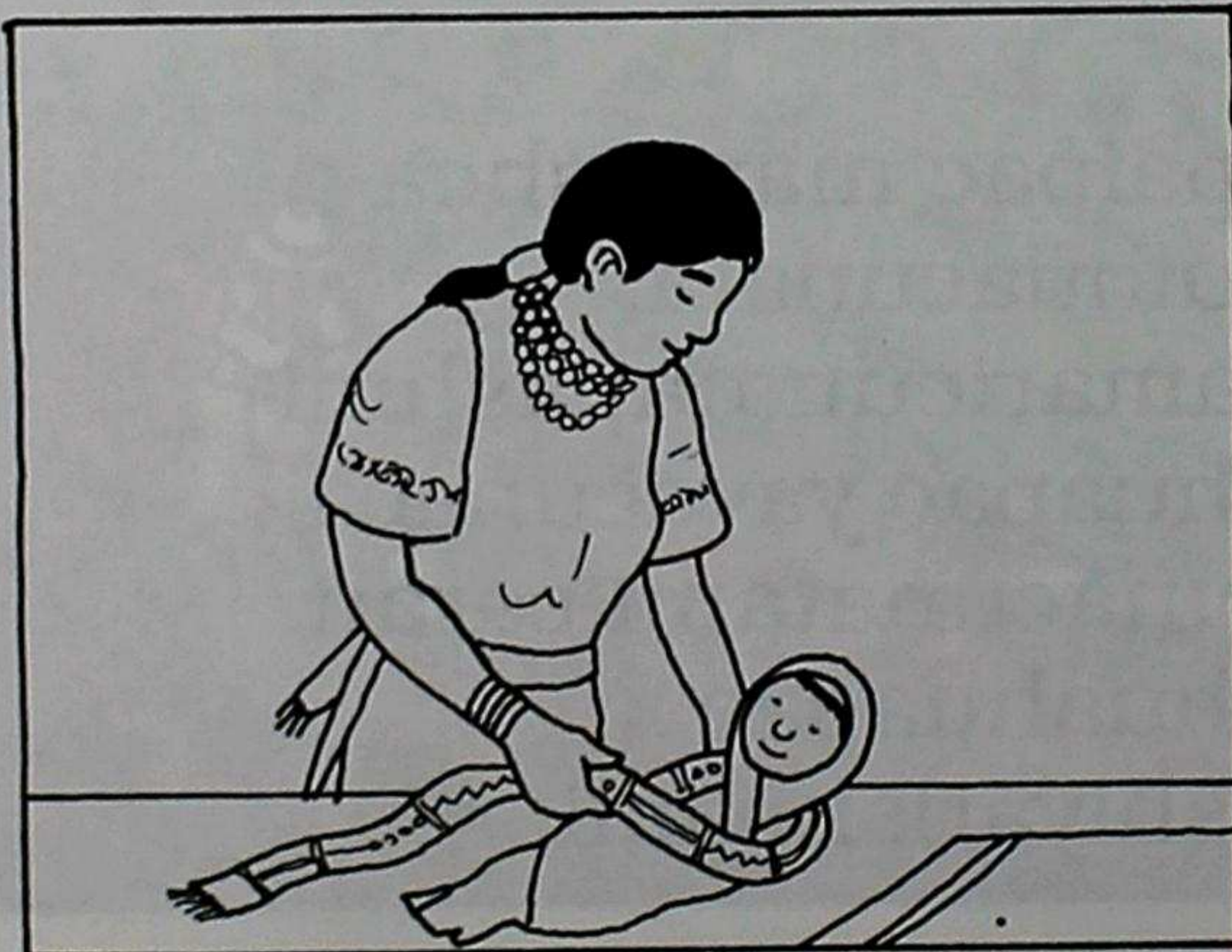
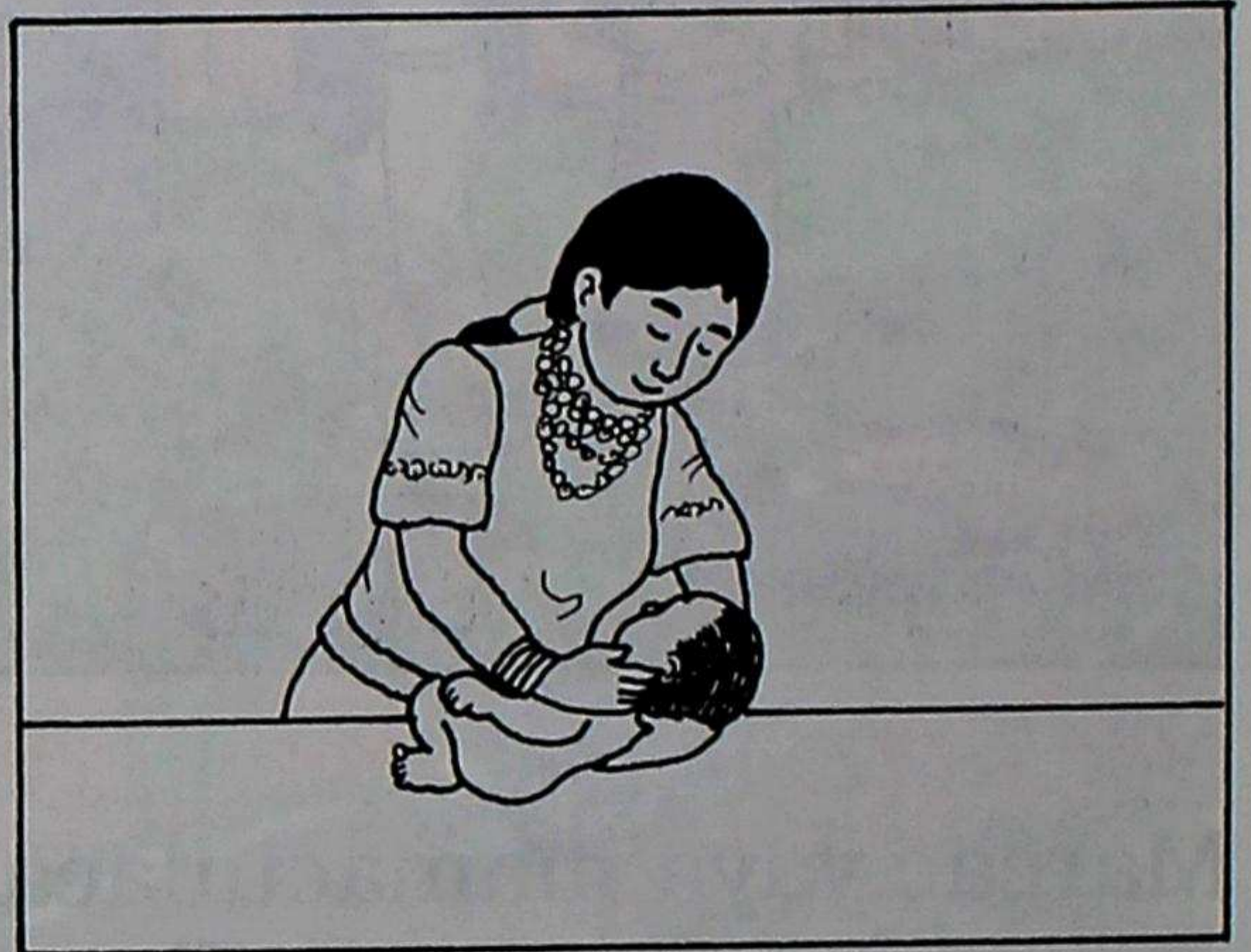
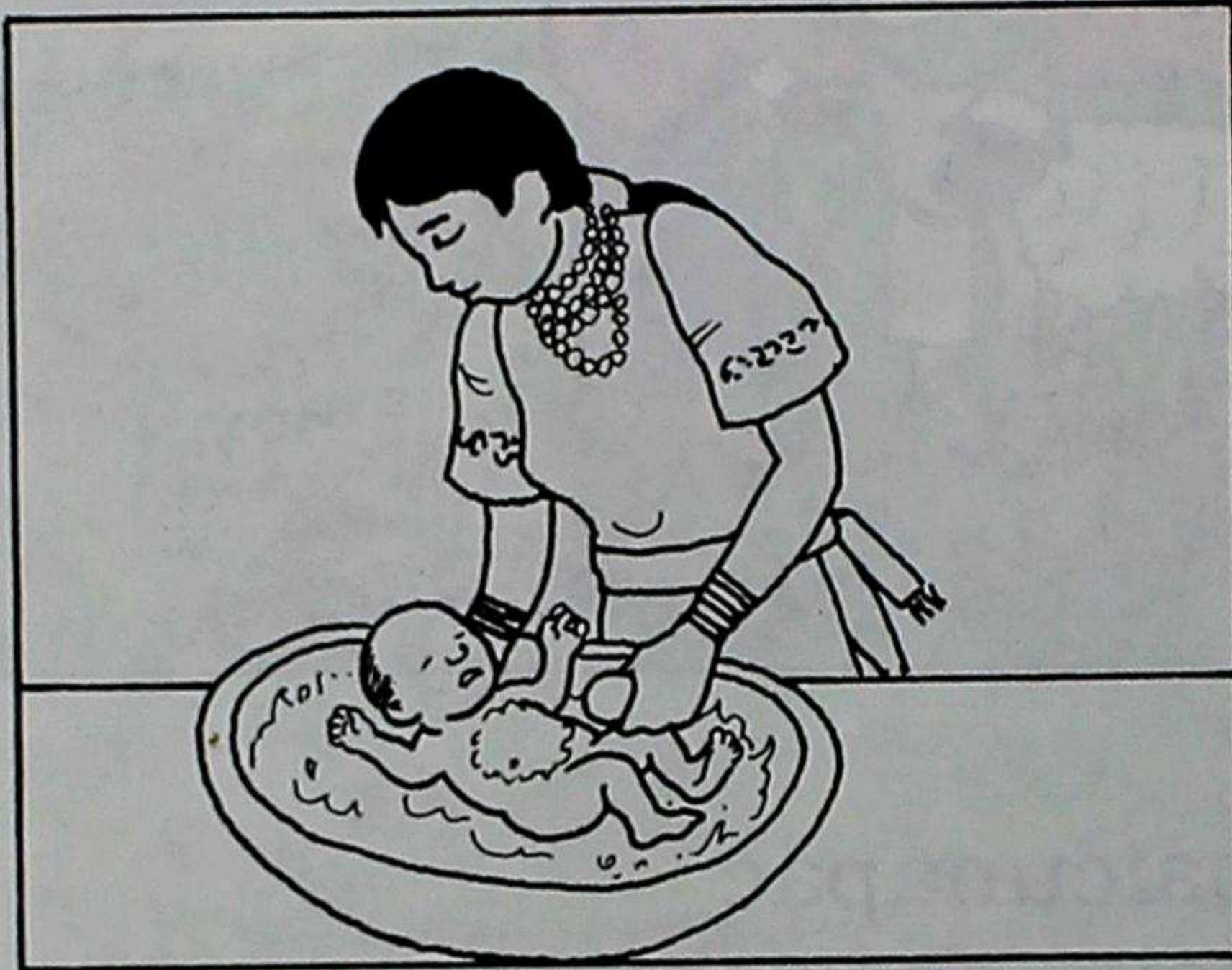
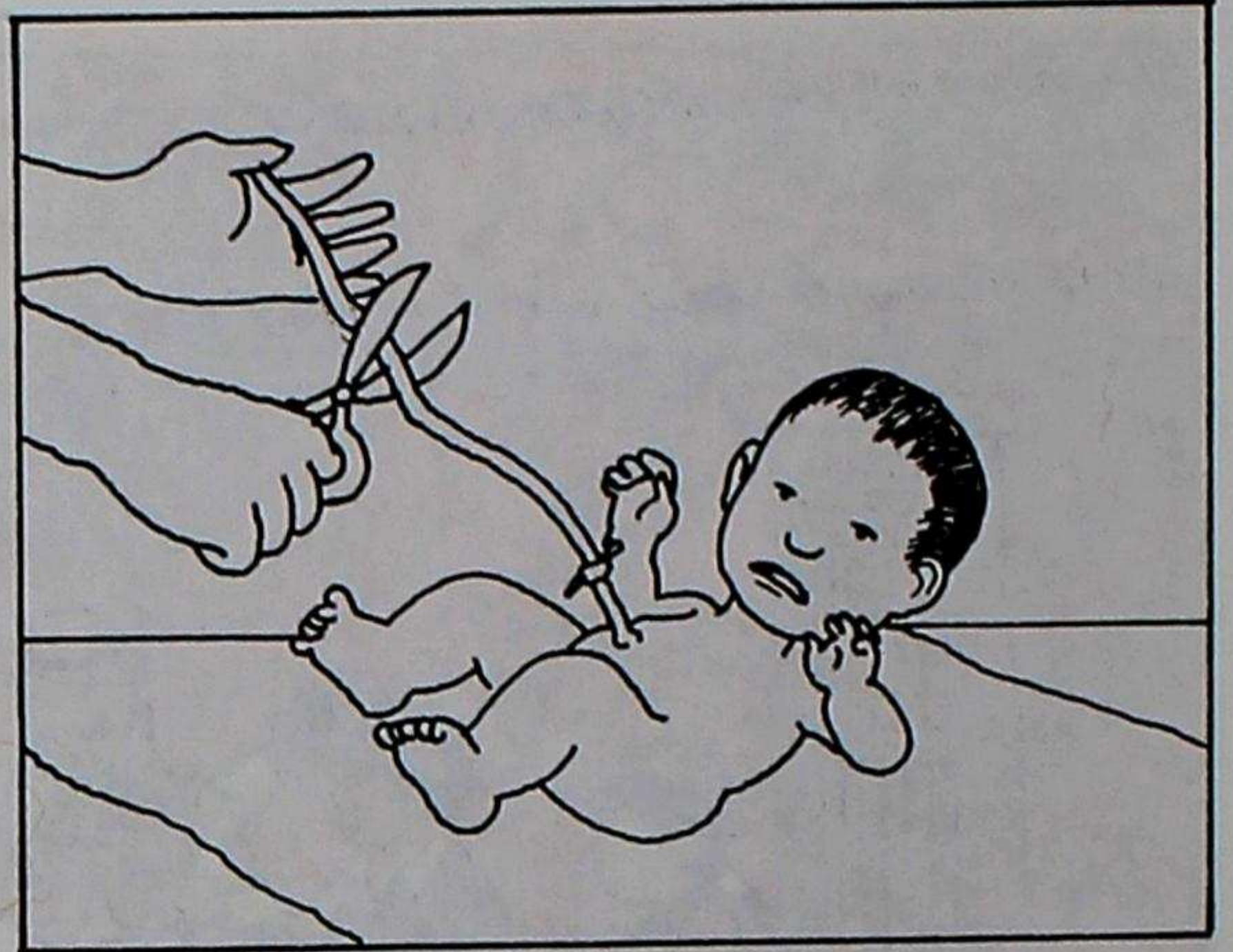
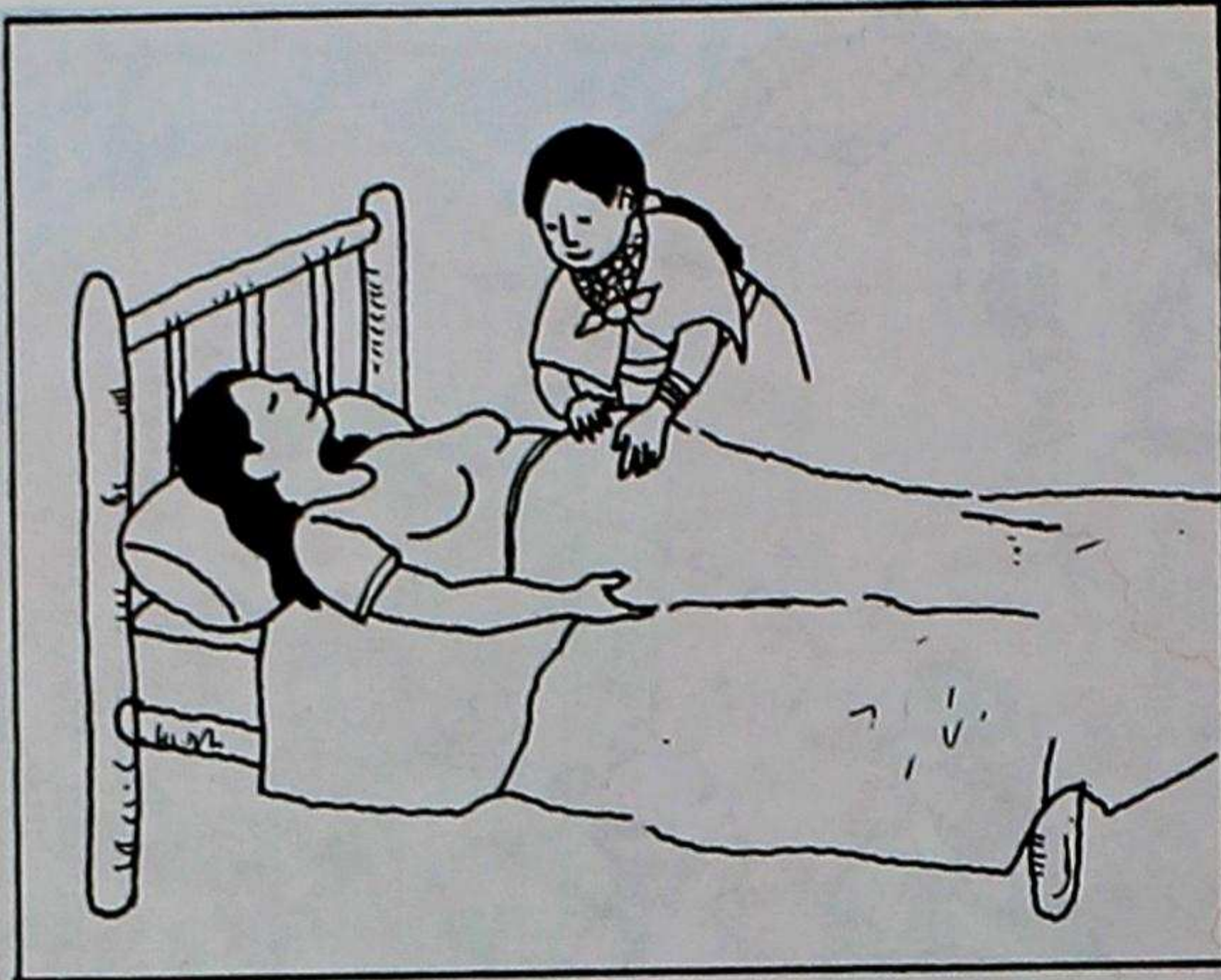



# Achic taita mamamanta



## apartic mama

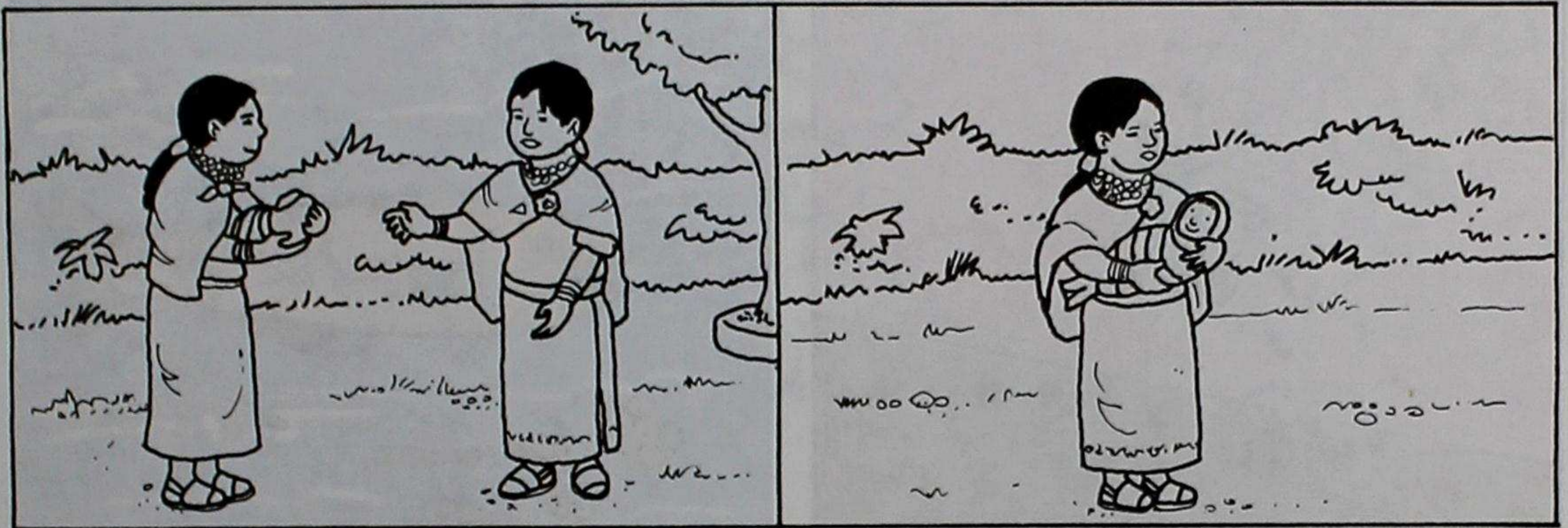

## marcac mama



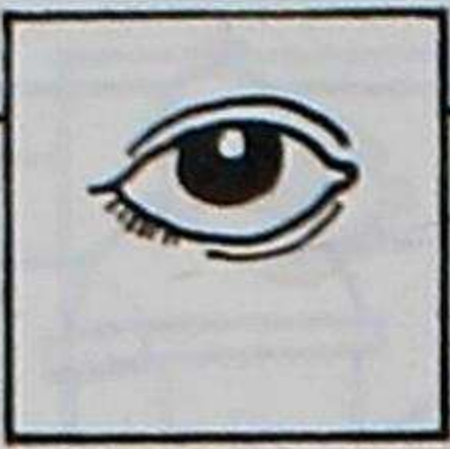

# Huacharinamanta

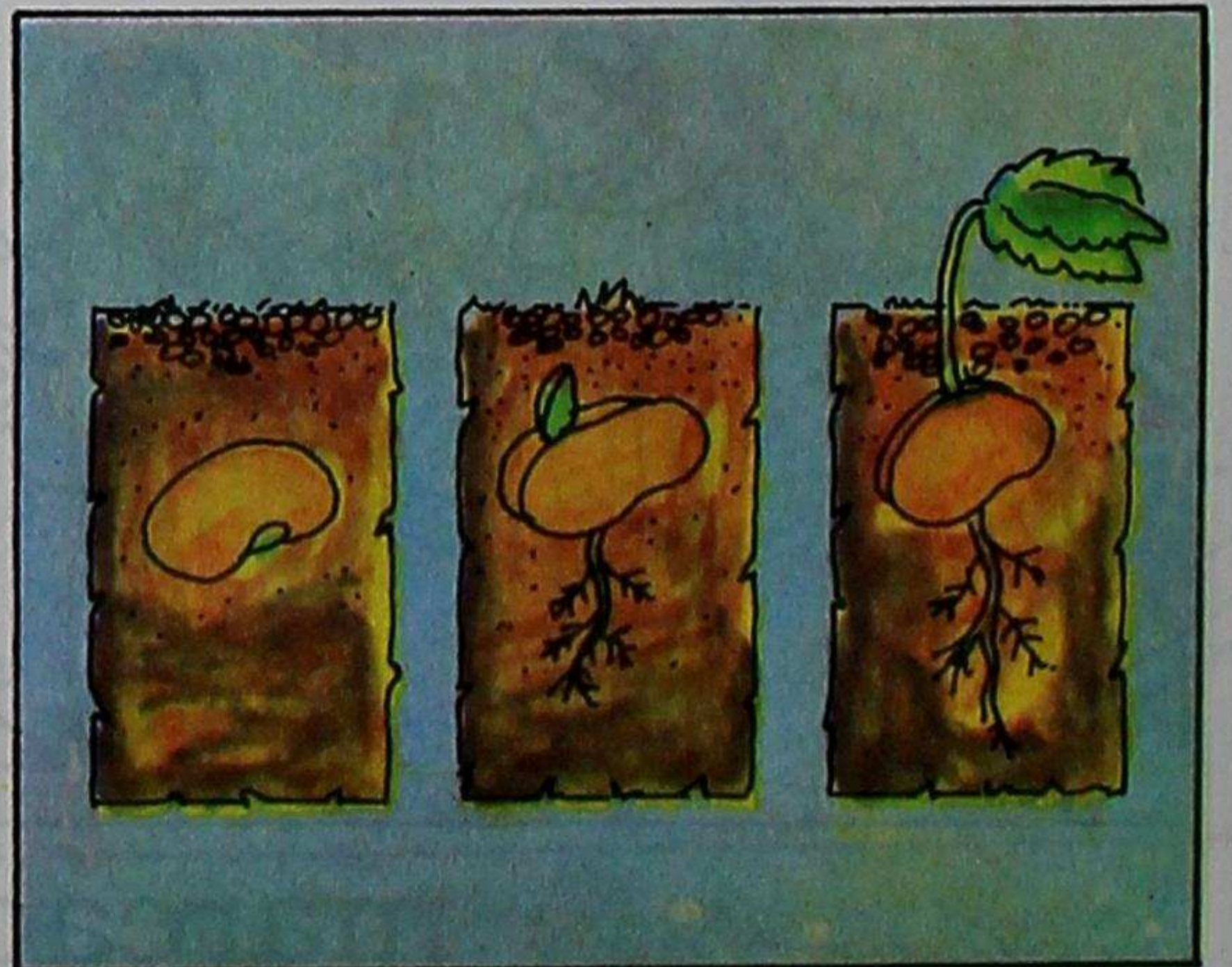
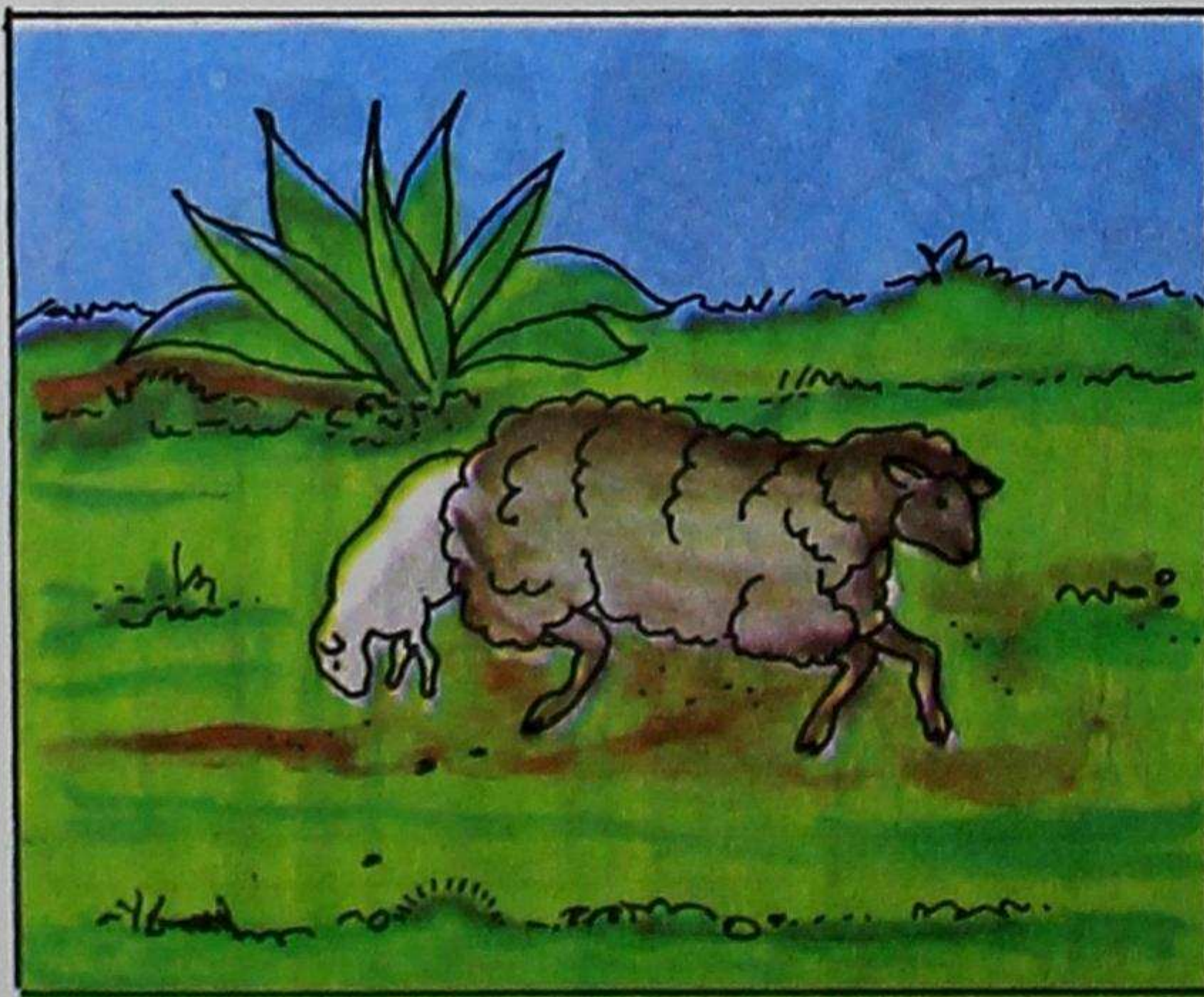
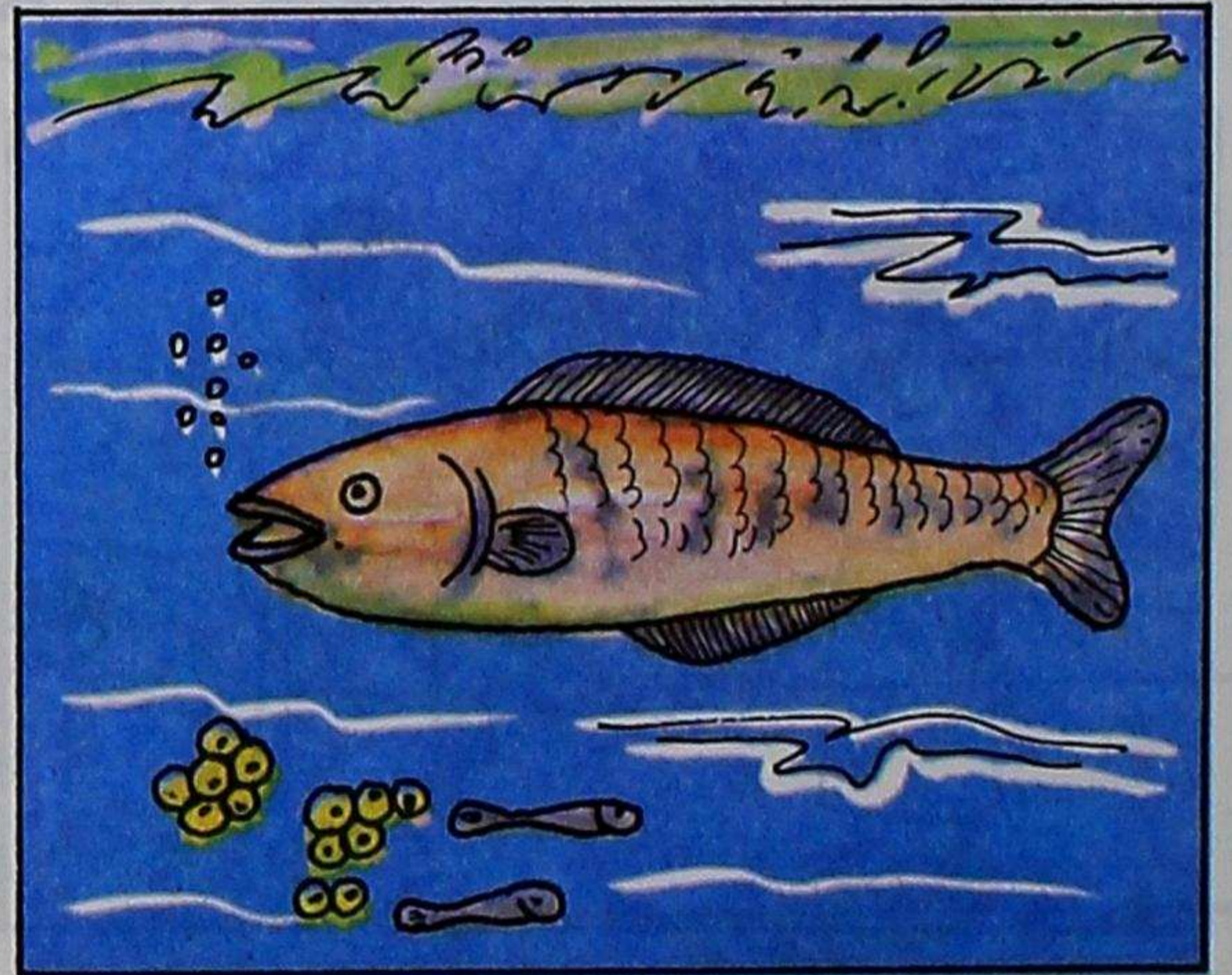
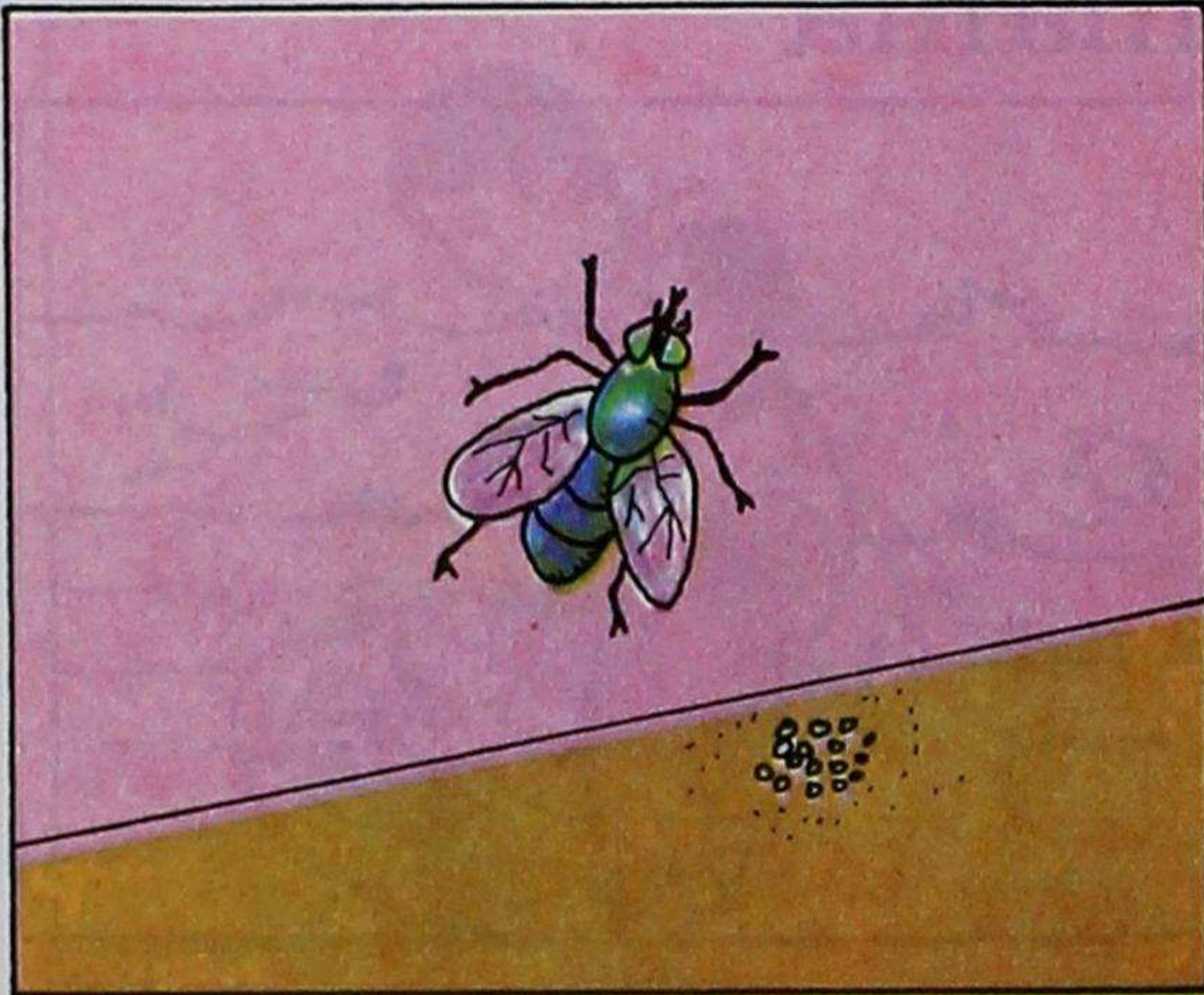
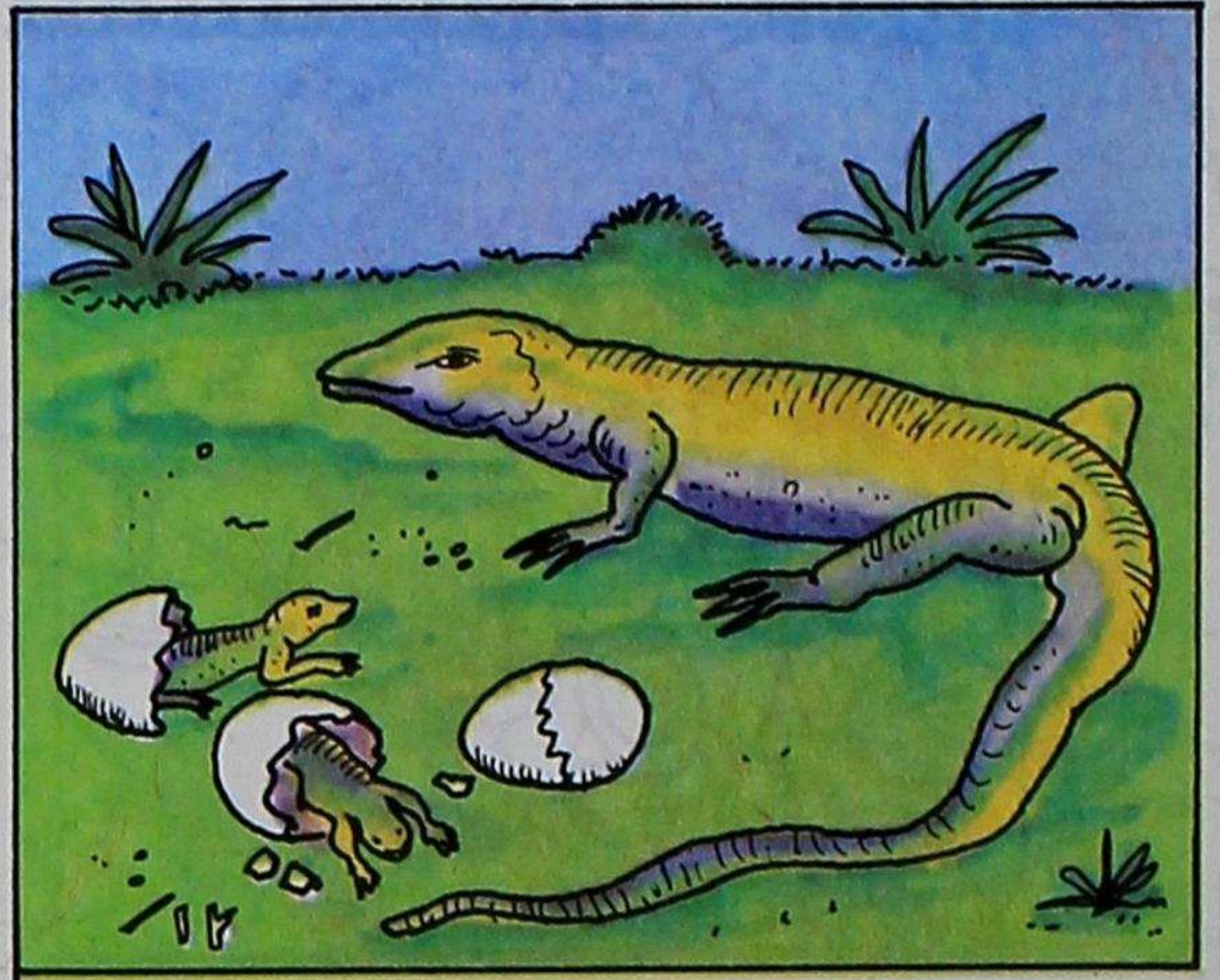



# Janpi yuracunamanta



Ñucaca yachaemi cani cai yuracunahuanmi unculcunata janpini

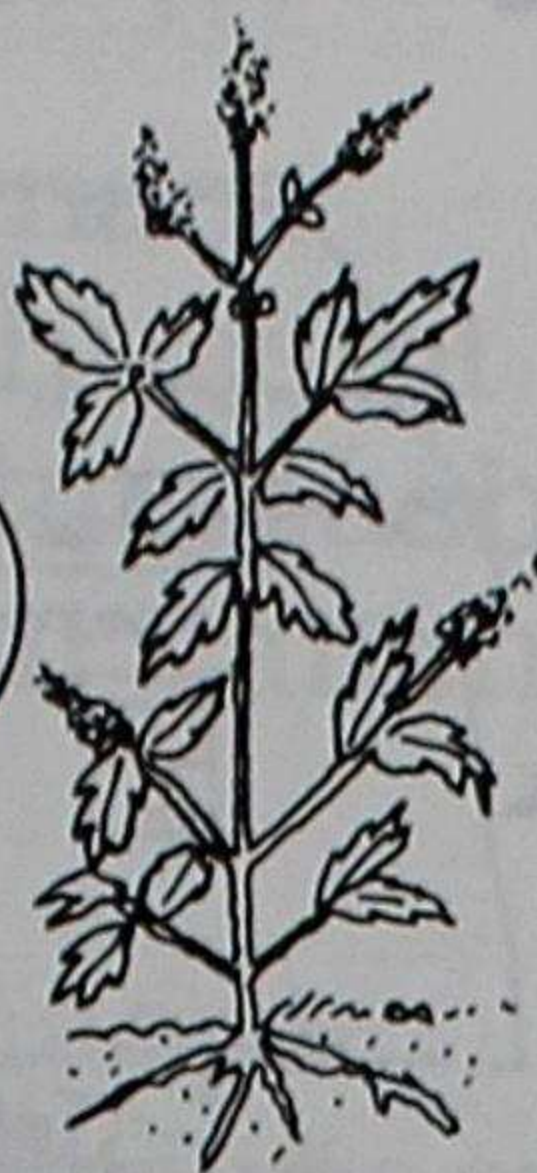

Ñucaca: verbenami cani culcatami huañuchini yanushpa upiapahuai



Ñucaca cebollami cani: micuhuai unculcunataca callpachinimi

Ñucaca chillcami cani huairashcatami callpachini

Ñucami orégano cani: tullucunatami sinchiyachini



Ñucaca tsinimi cani huairashcatami llucshichini

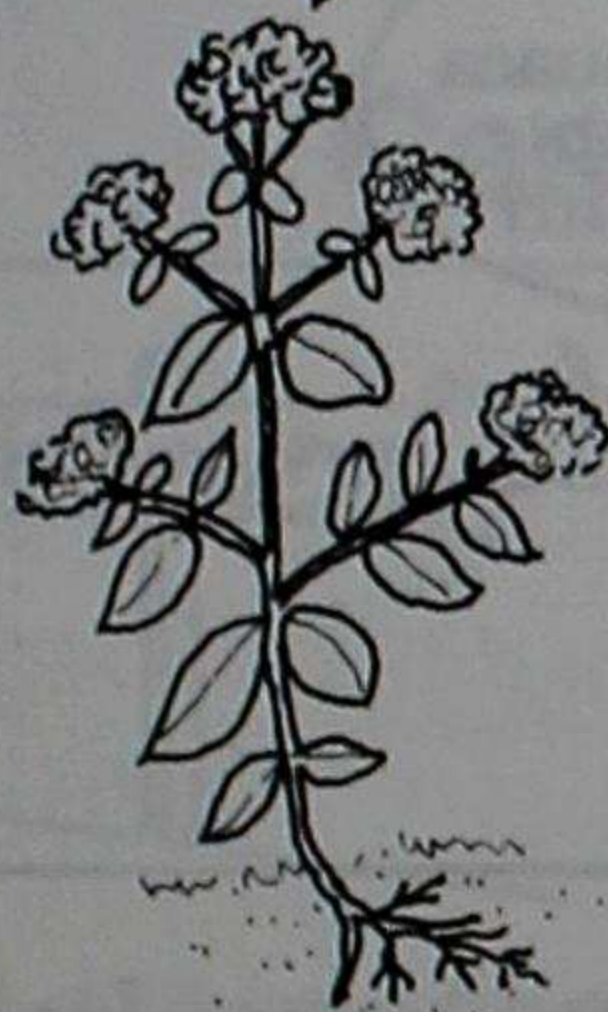

Ñucami caballochupa cani Shuncu uncuicunatami allichini

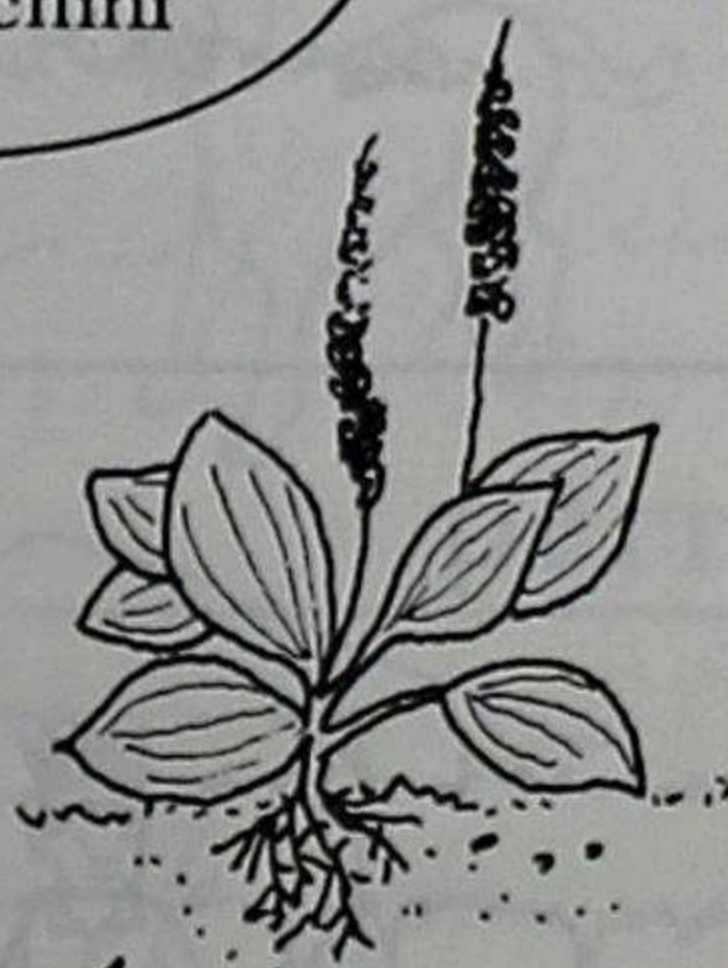
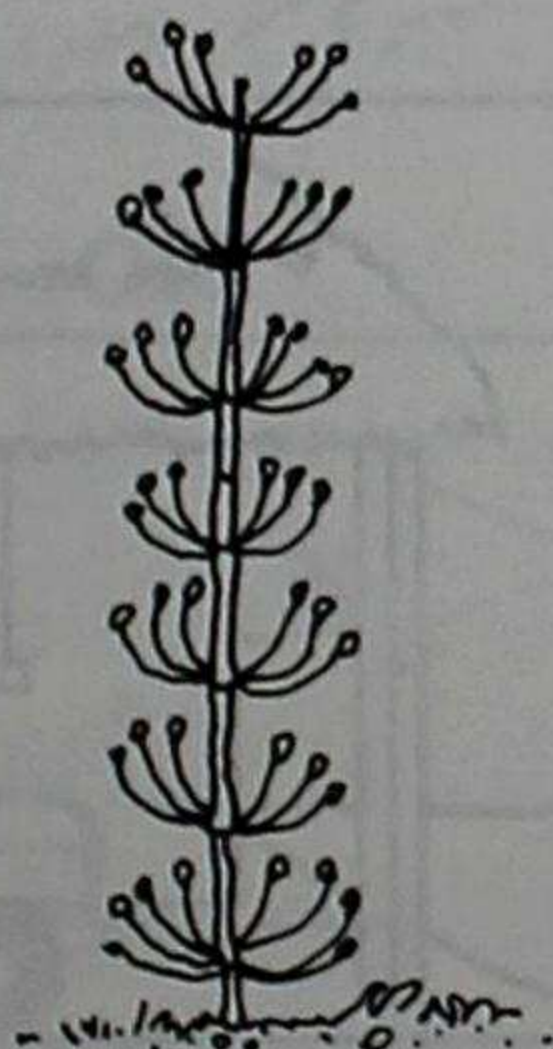

Ñucaca llanténmi cani riñónpacmi alli cani

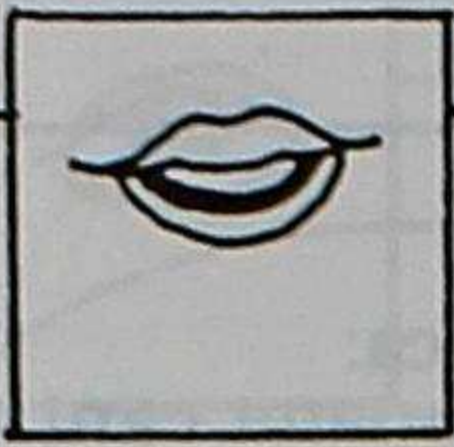

# Janpic shina puclashunchic

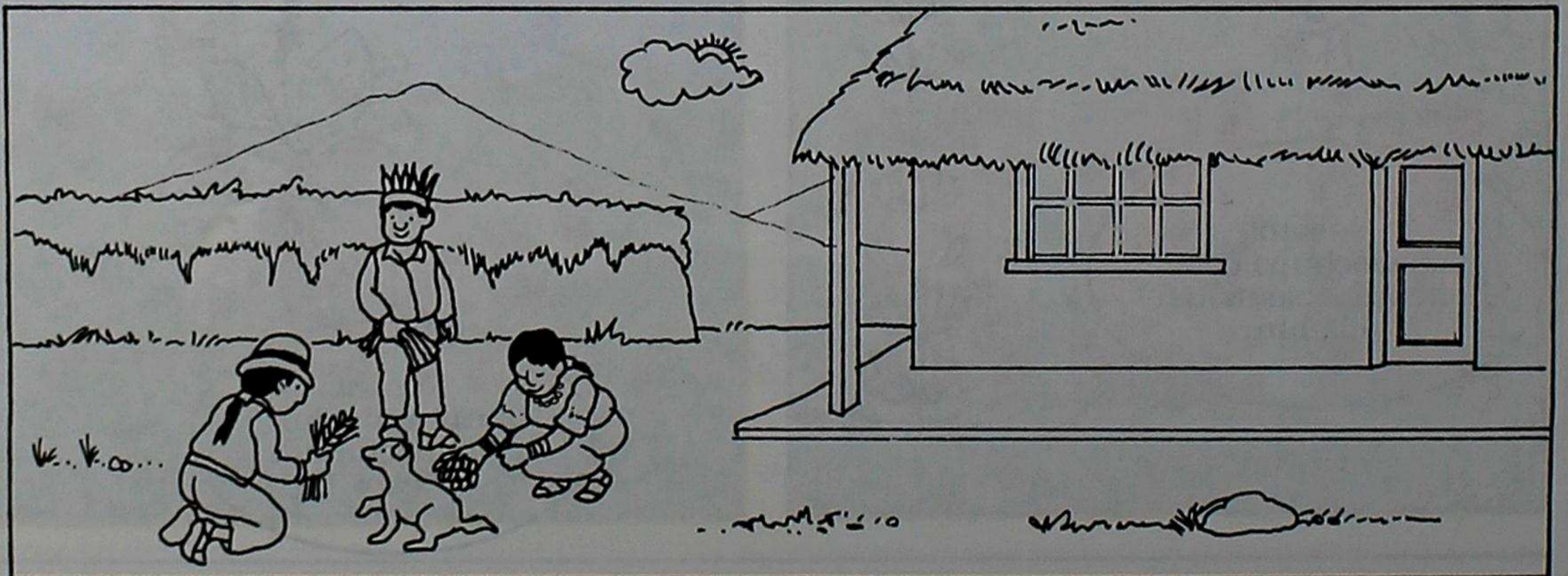
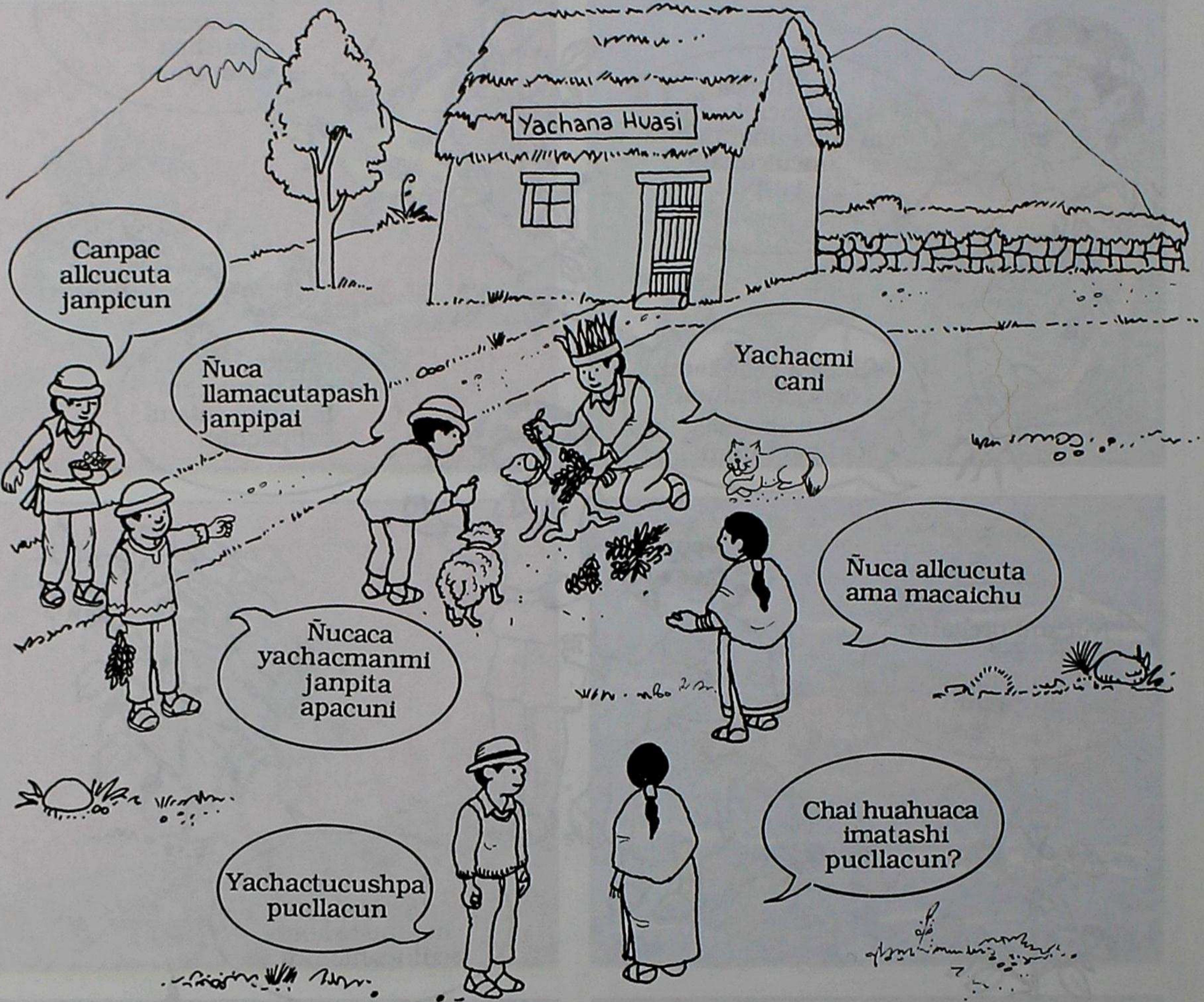

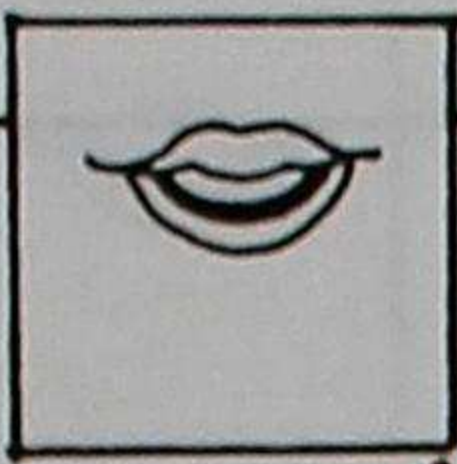

# Huahua cashcamanta



Huahuacunaca  
canchapi huasipi  
maipi cashpapash  
pucllanami canchic.



Mama piñacpi  
yachachic piñacpi,  
huahua cashcamanta  
pucllaita munanchic.



Mashicucuna runa,  
mishu cashpapash  
maimanta cashpapash  
pucllaiman  
shamuichic.



# Castellanomanta quillcacuna

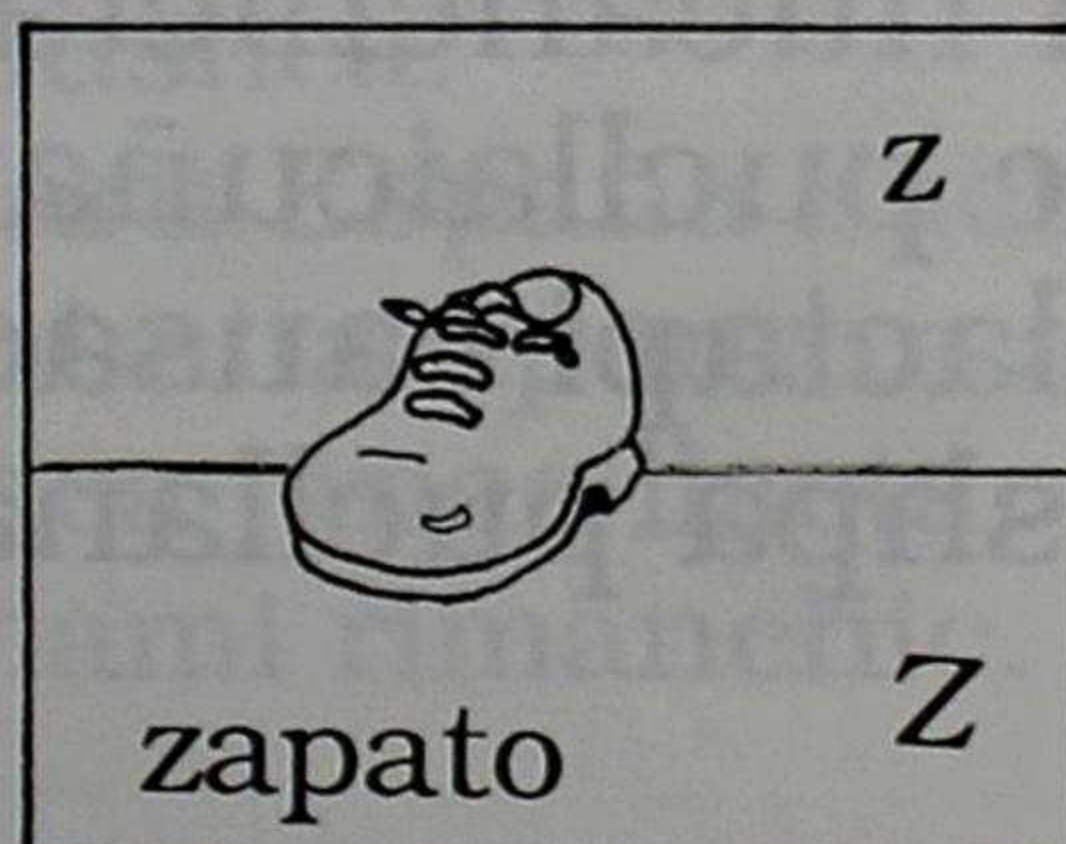
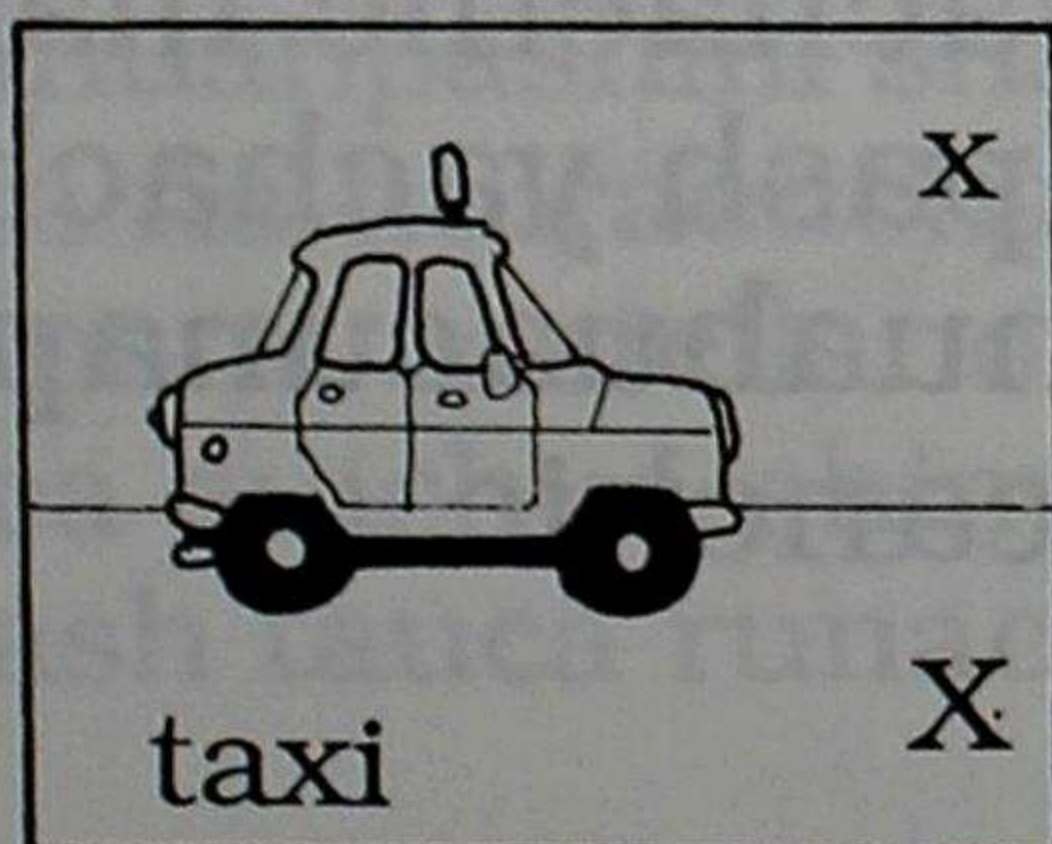
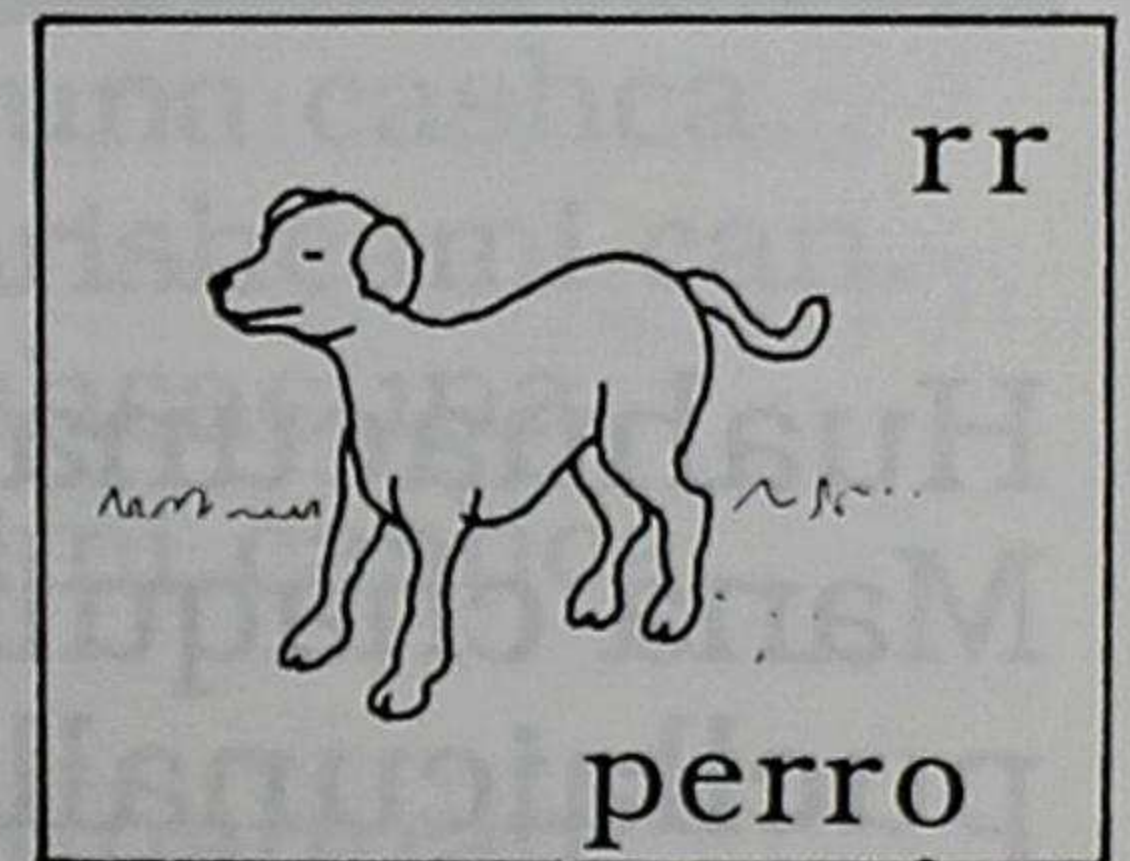
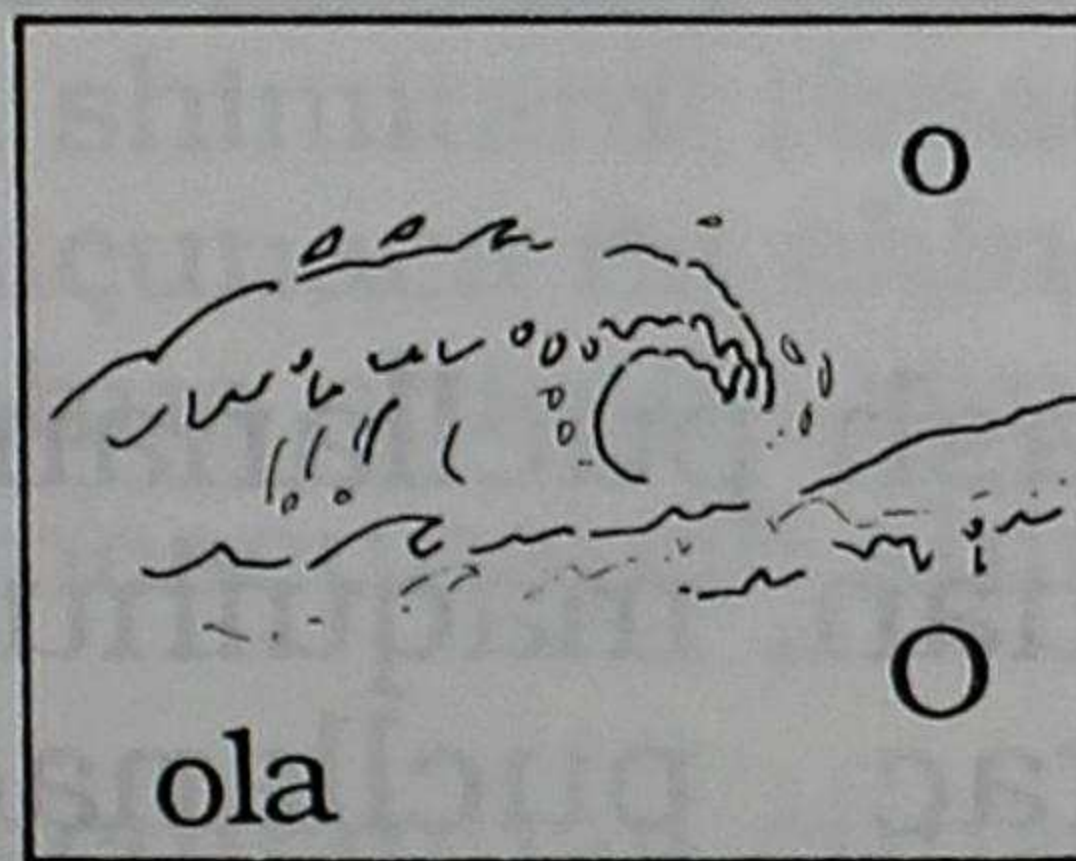
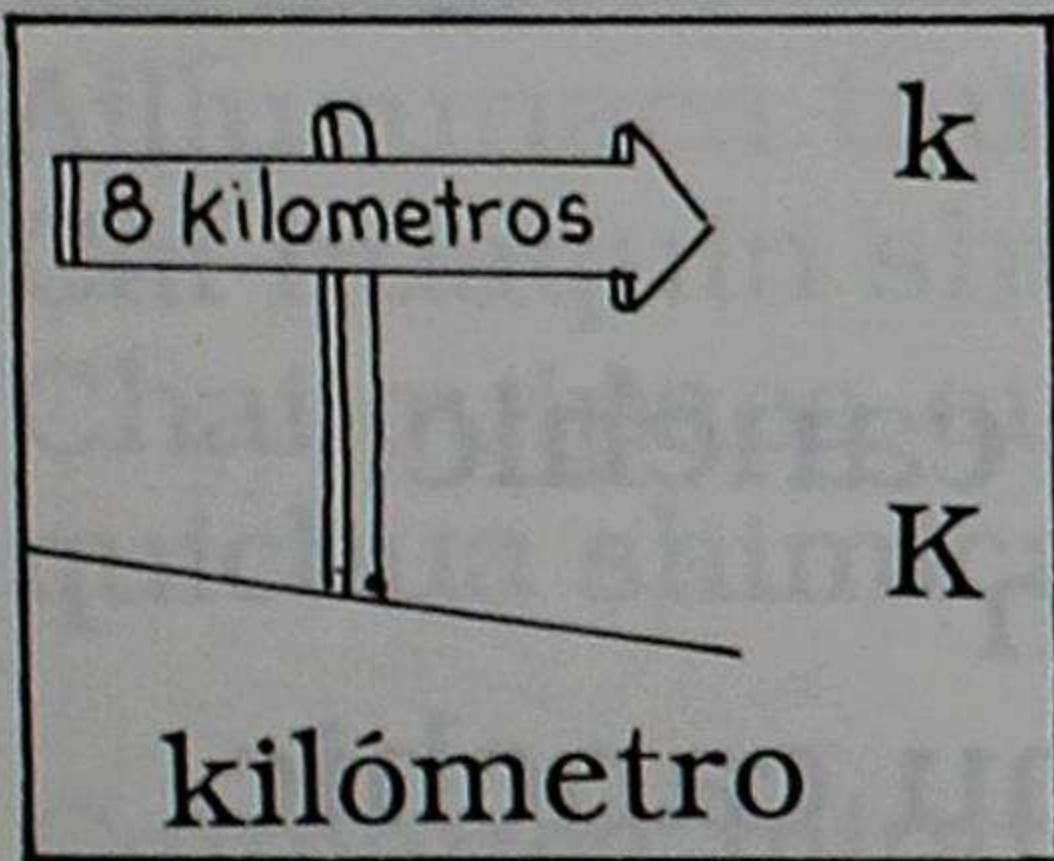

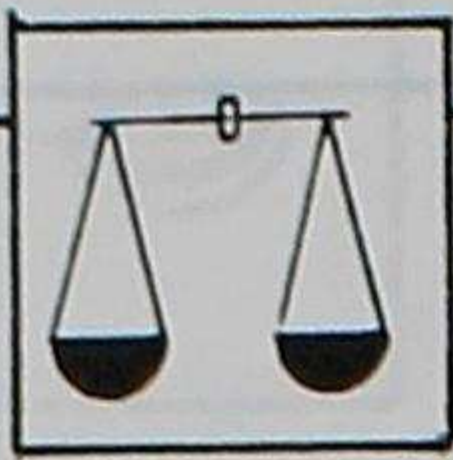

# Pucllanamanta



Huahuacunapash pucllanami canchic.  
Mana chaquihuan, maquihuan  
pucllaicunallatac pucllanachu canchic.  
Chaimi ñucanchicta yachachic mashica  
shuctac pucllaicuñatapash yachachin.  
Tucui llactapi causac huahuacunapura  
tantarishpa pucllana canchic.

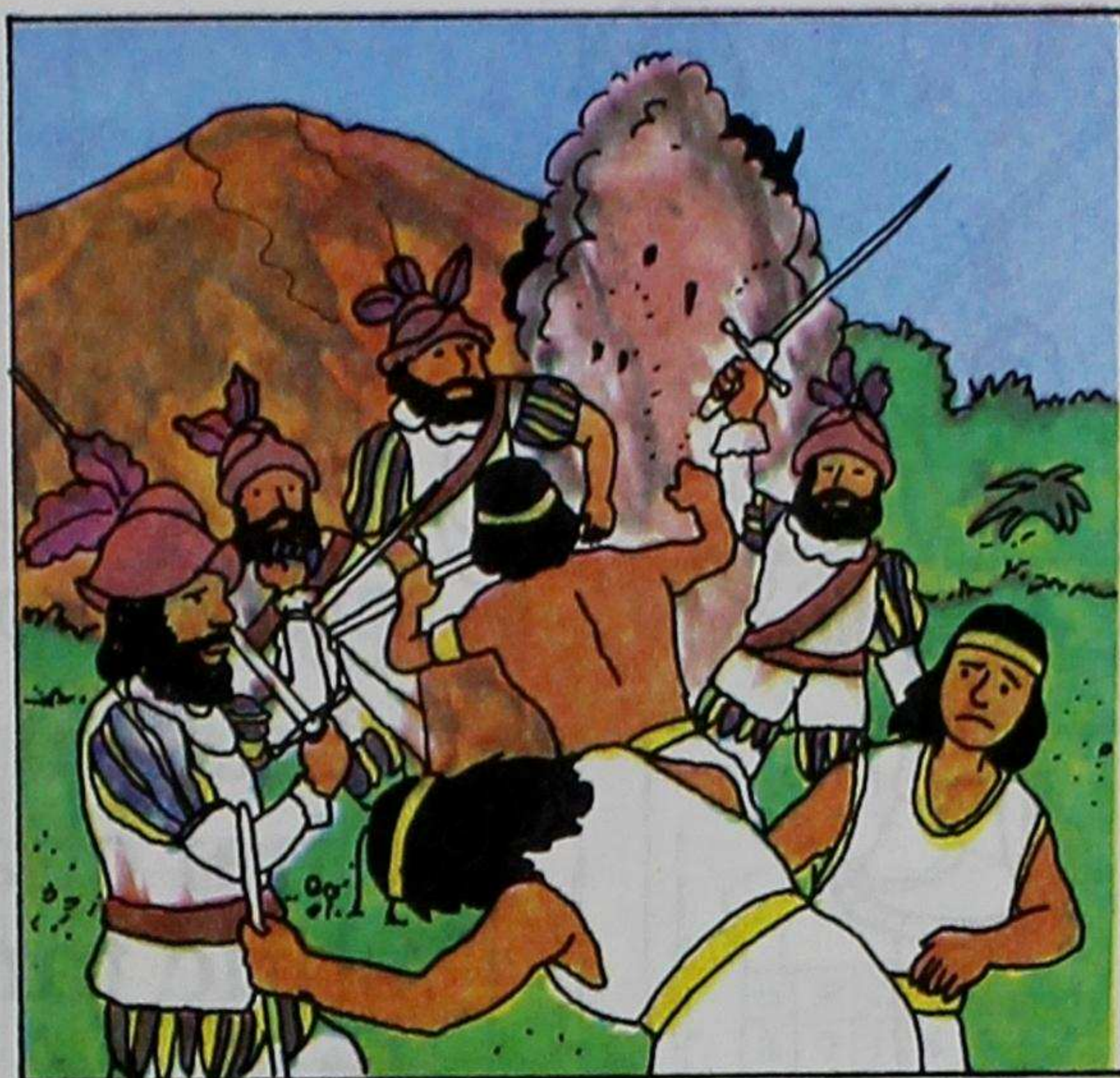
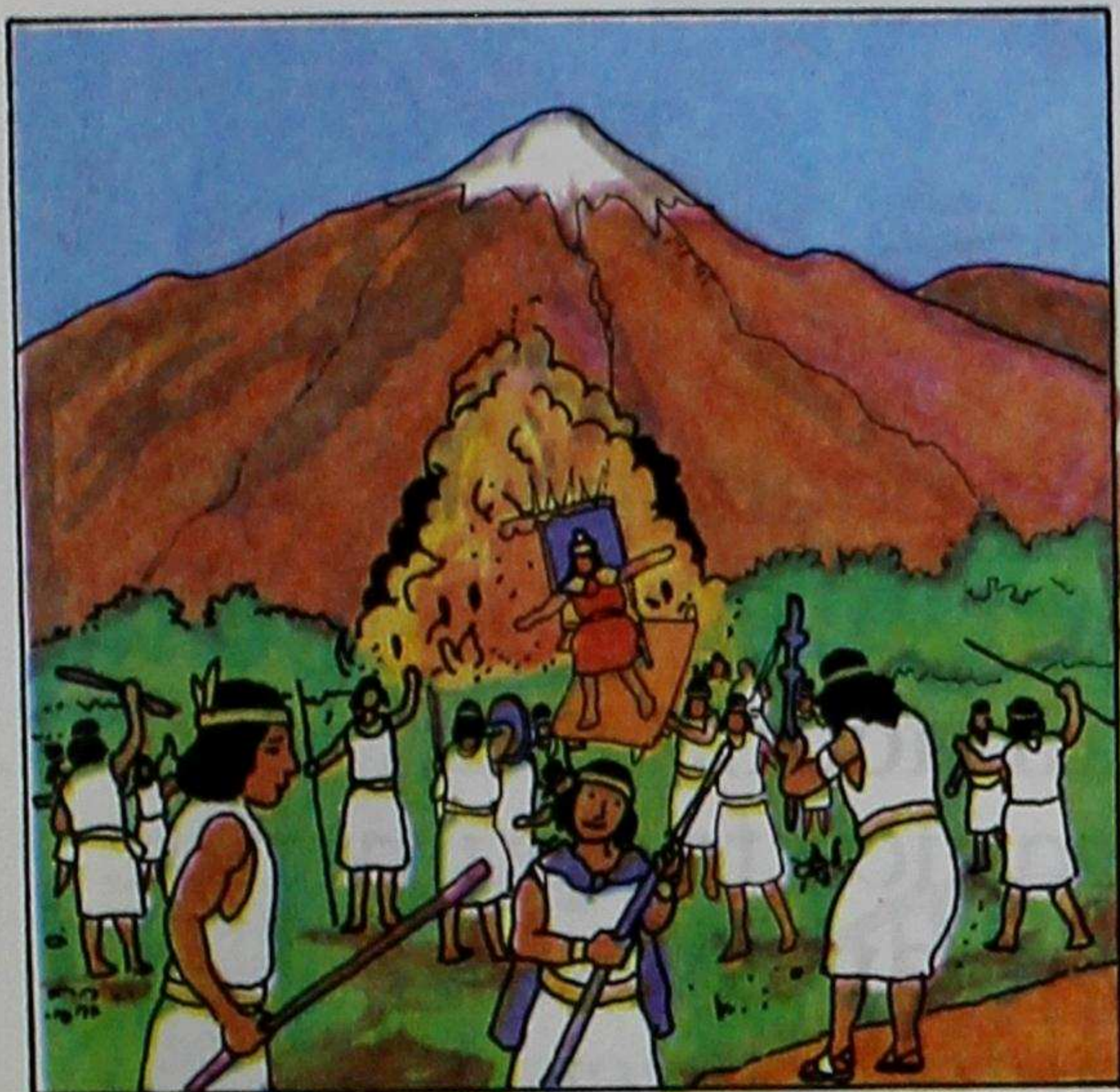
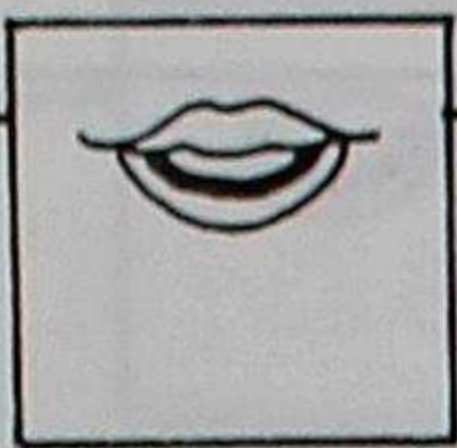

## Quichua shimimanta

Ñaupaca cai llactacunapica tauca aillucunami  
tiyashca.

Cai aillucunataca curacacunami pushaccuna cashca.

Aillucunaca tauca shimitami rimaccuna cashca.

Cai huaquin shimicunaca ña chincarishcami can.

Chai quipaca quichua shimita rimashcacuna

quichua shimica incacunapac shimimi cashca.

Caimanca mindalacunahuan, cunaccunahuan,  
aucacunahuanpashmi shamushca.

Quipaman ña huiracucha caru España llactamanta  
shamushpami castellano shimita apamurcacuna.

Cunanpica quichua shimitaca janac llactapi, urai  
llactapipash tauca runacunami rimanchic.



## Chasquimanta

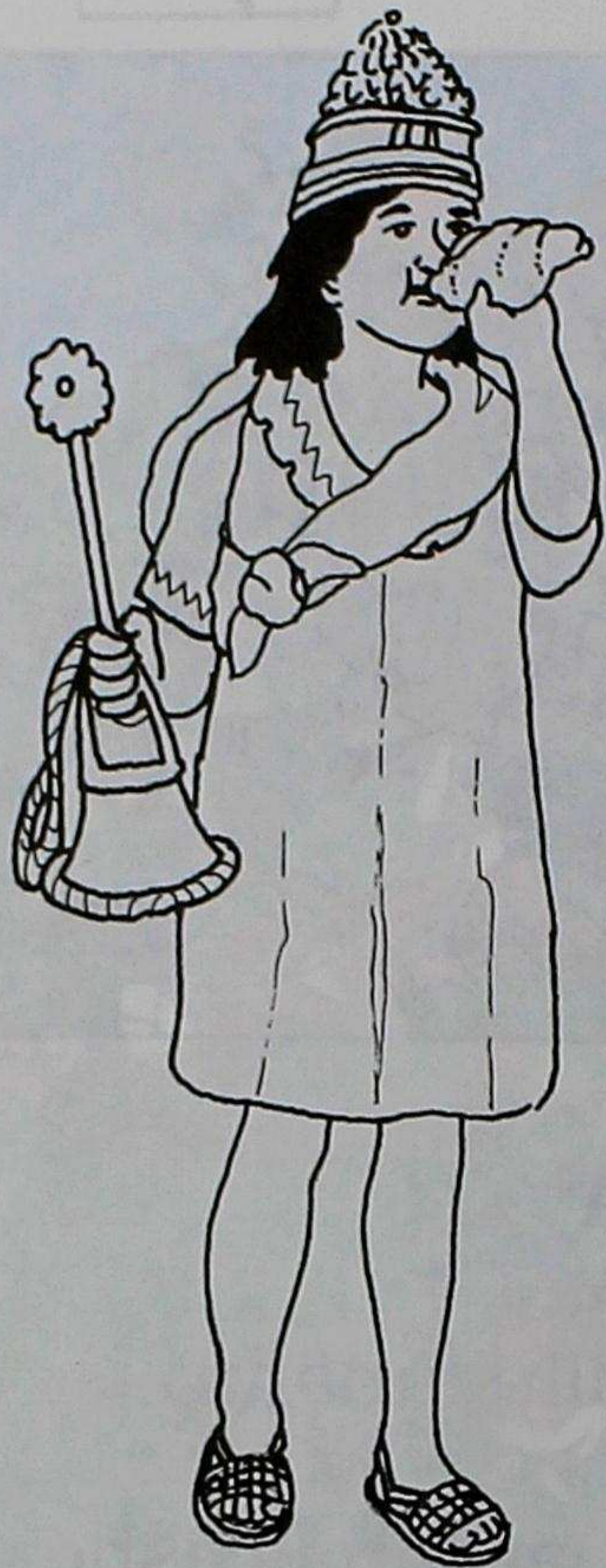

Ñaupá inca pachapica  
curacapac churicunami  
chasqui runacuna cashca.  
Chai chasquica tanpumanta  
shuc tanpucaman  
huillaicunata apaccuna  
cashca.  
Chasquica paipac umapi  
shuc yurac patpatami  
chariccuna cashca.

Paicuna chayashcataca mama  
cuchamanta churuhuan uyachishpami  
huillaccuna cashca. Cai churuca pututu  
shutiyucmi cashca.

Chasquicunaca apucmanca,  
tarpunamanta, micunamanta,  
uncuimanta huillaicunatami apaccuna  
cashca.



## Ñaupá huillaccunamanta

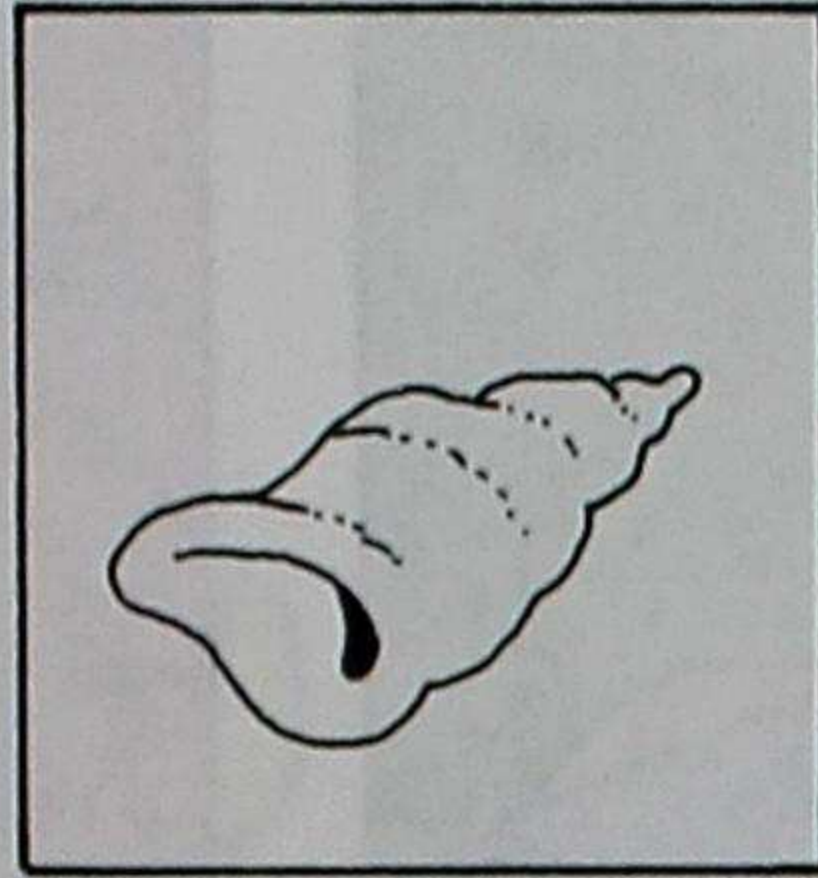

pututu

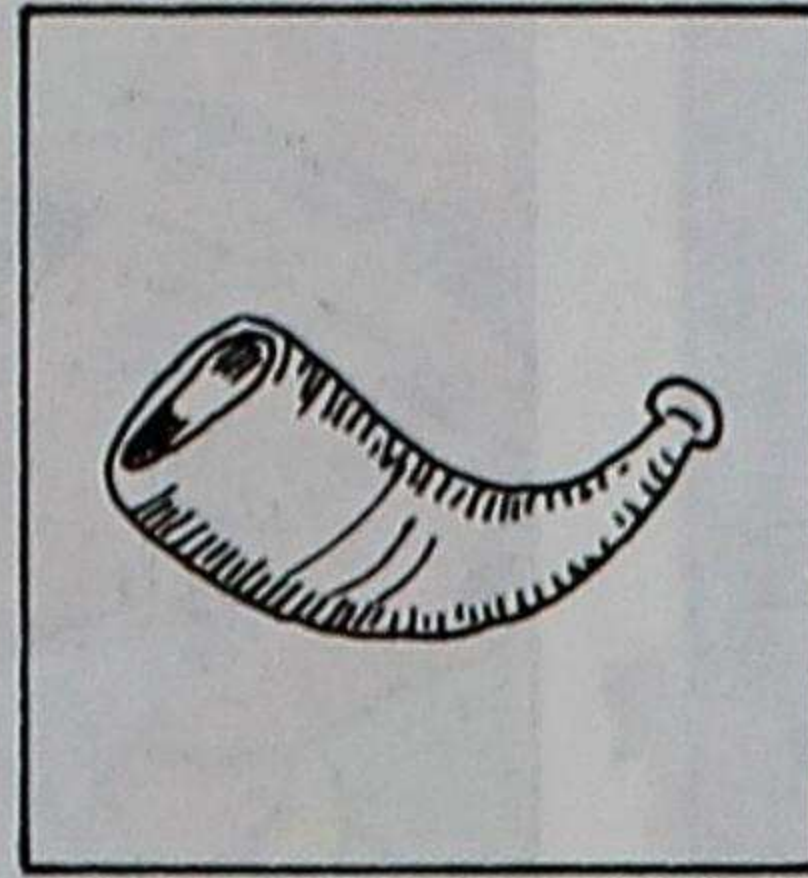

çachu

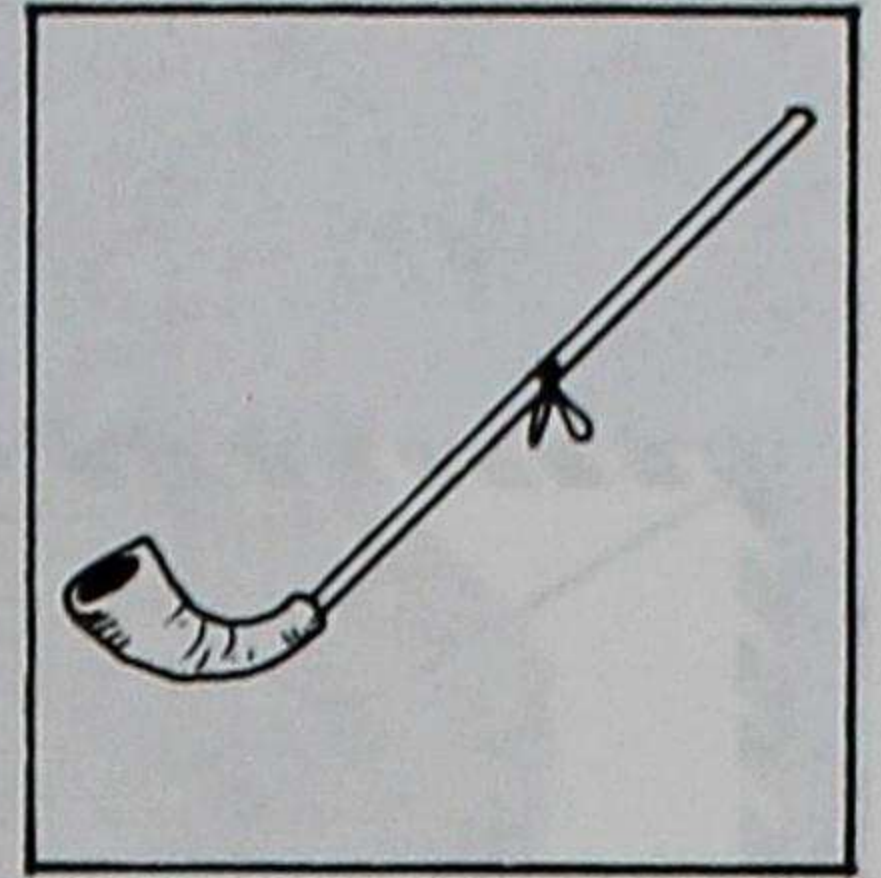

quipa

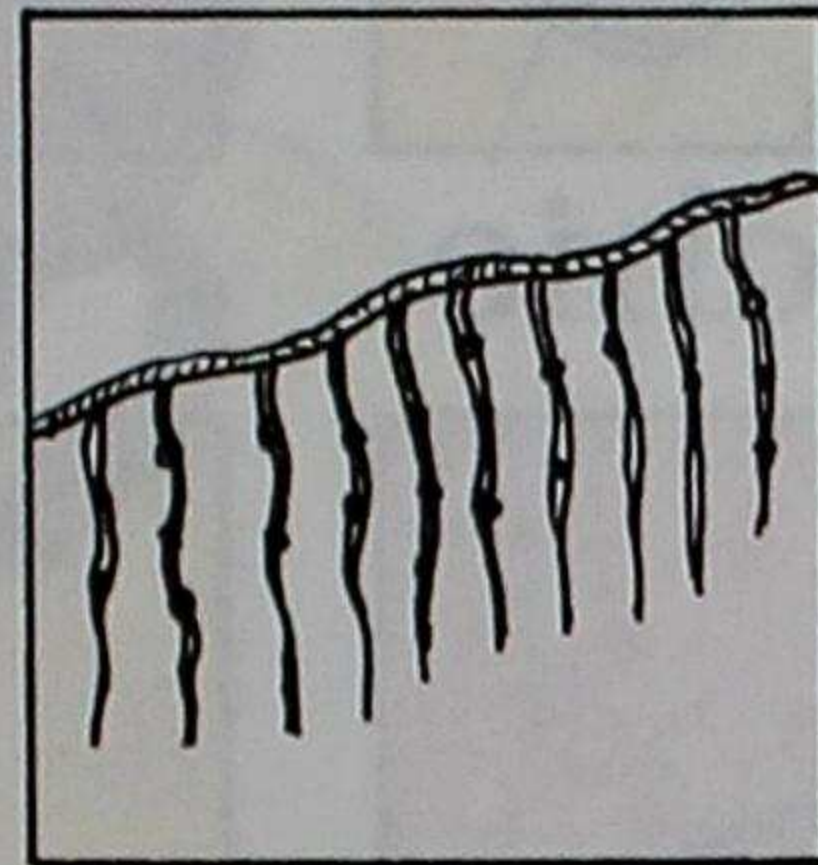

quipu

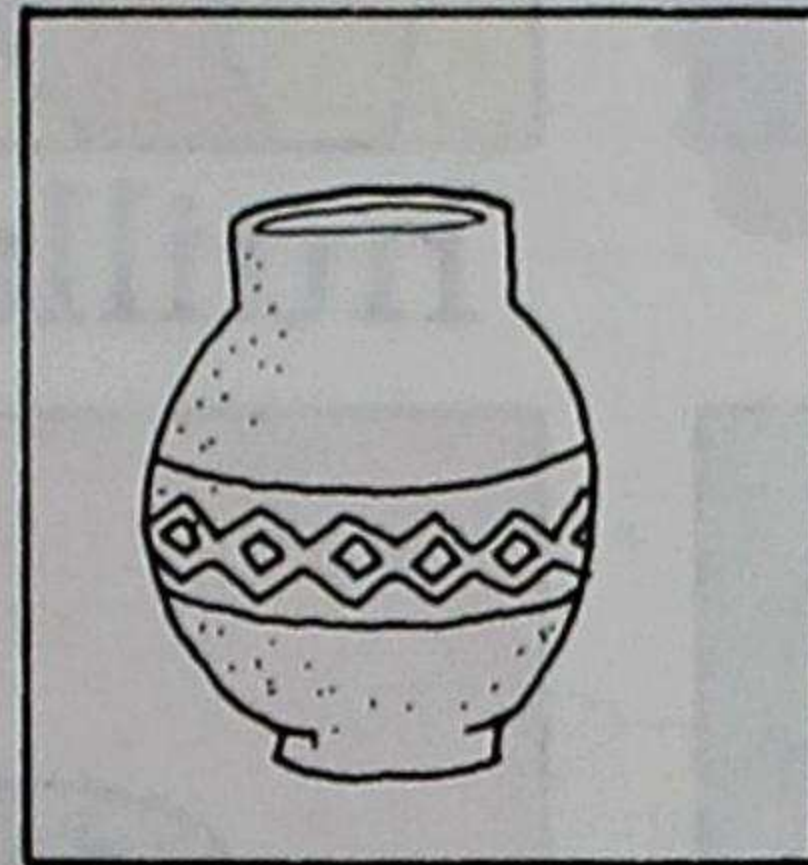

queru

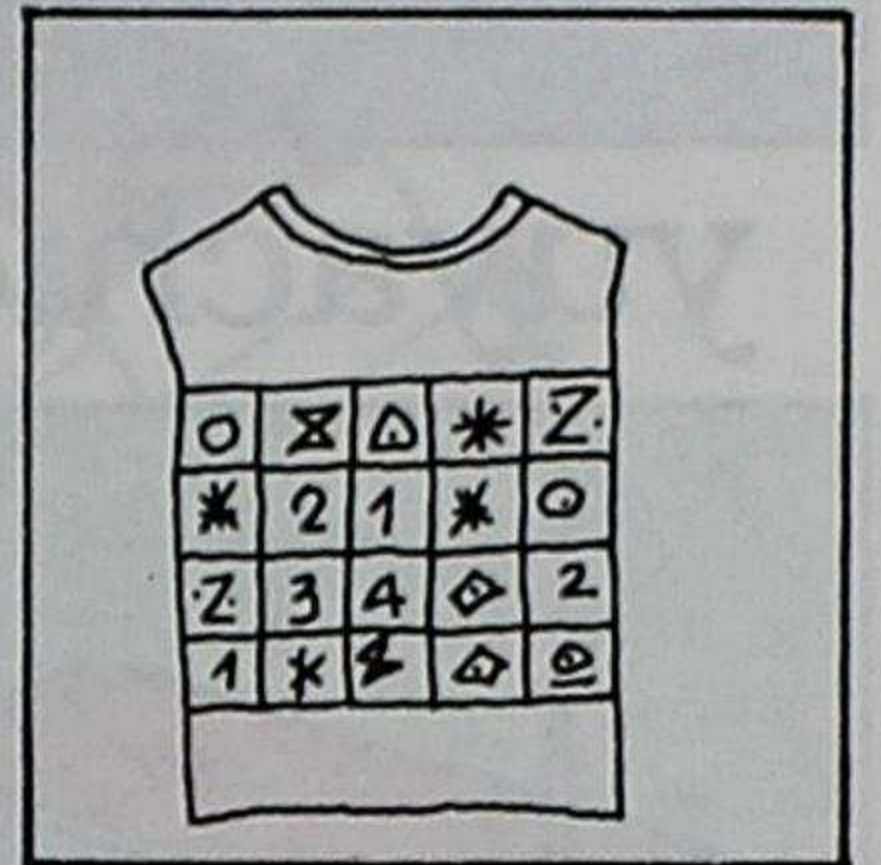

tocapu

## Cunan huillaccunamanta

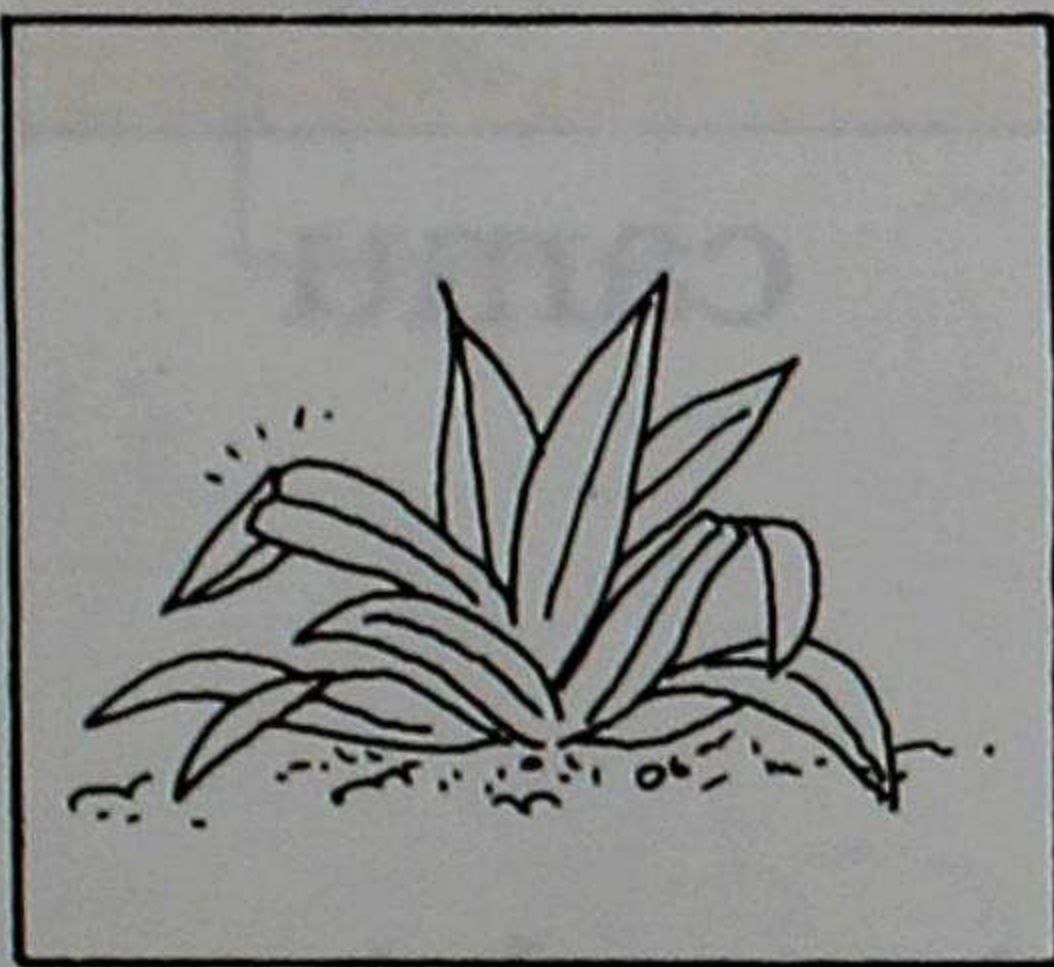

tsahuar  
chillpishca

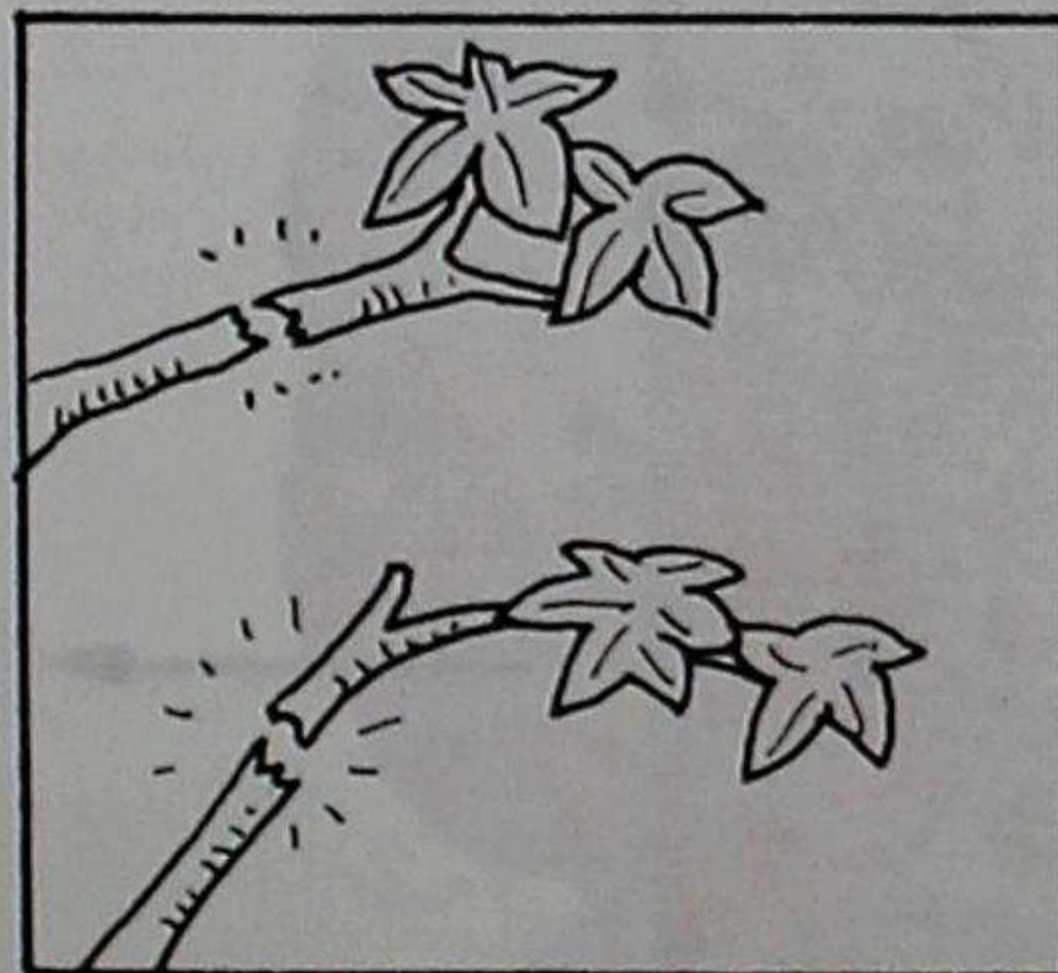

mallqui  
pitishca



caparina



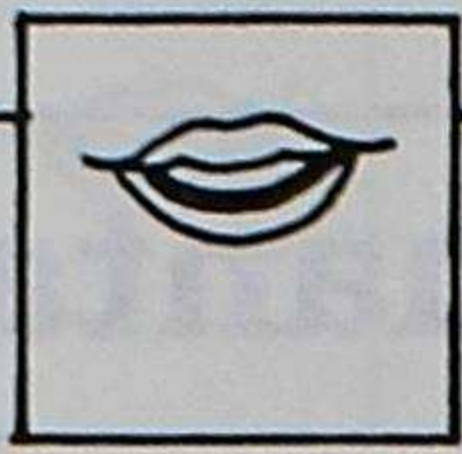

# Mushuc huillaccunamanta

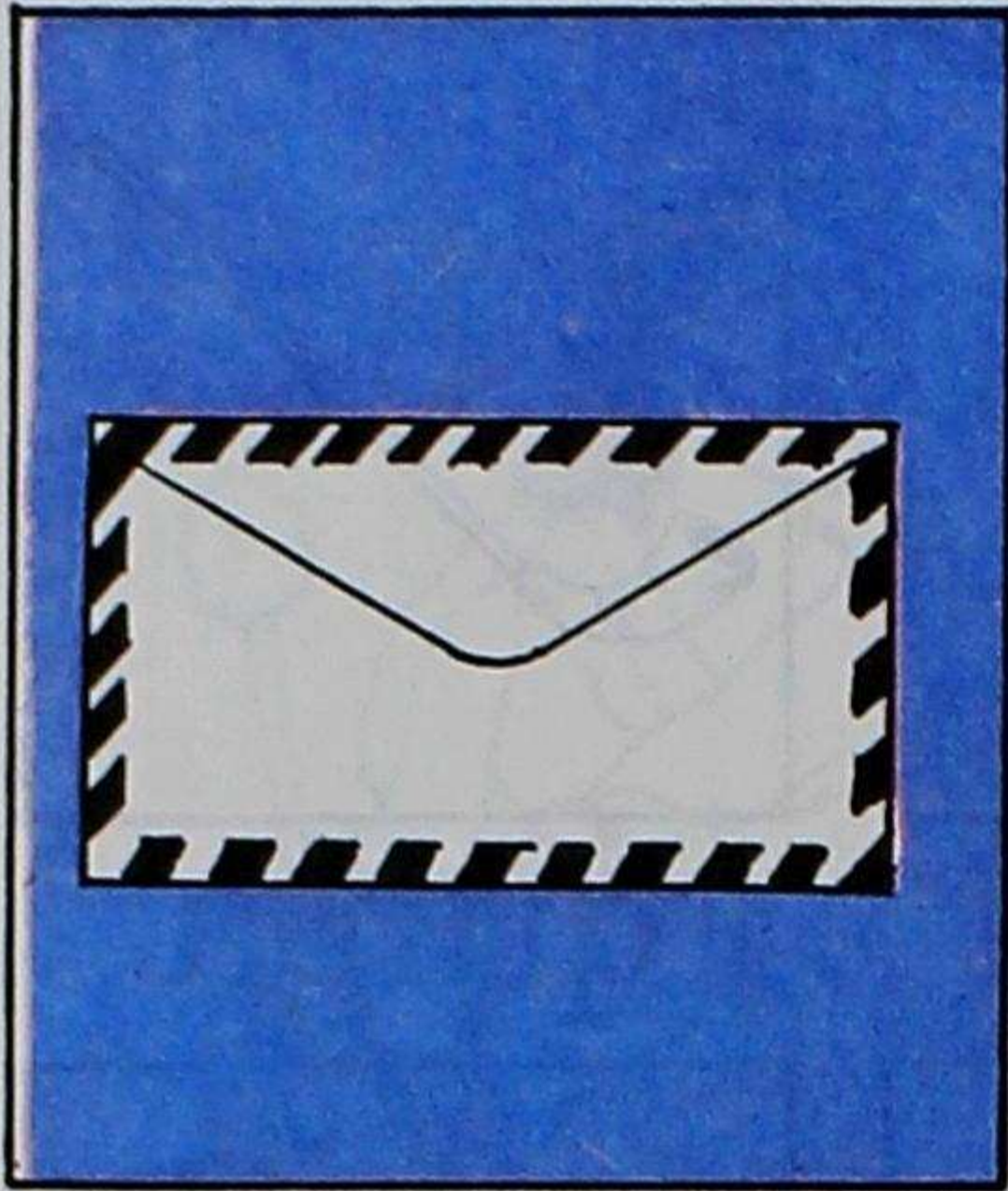

yuyachic

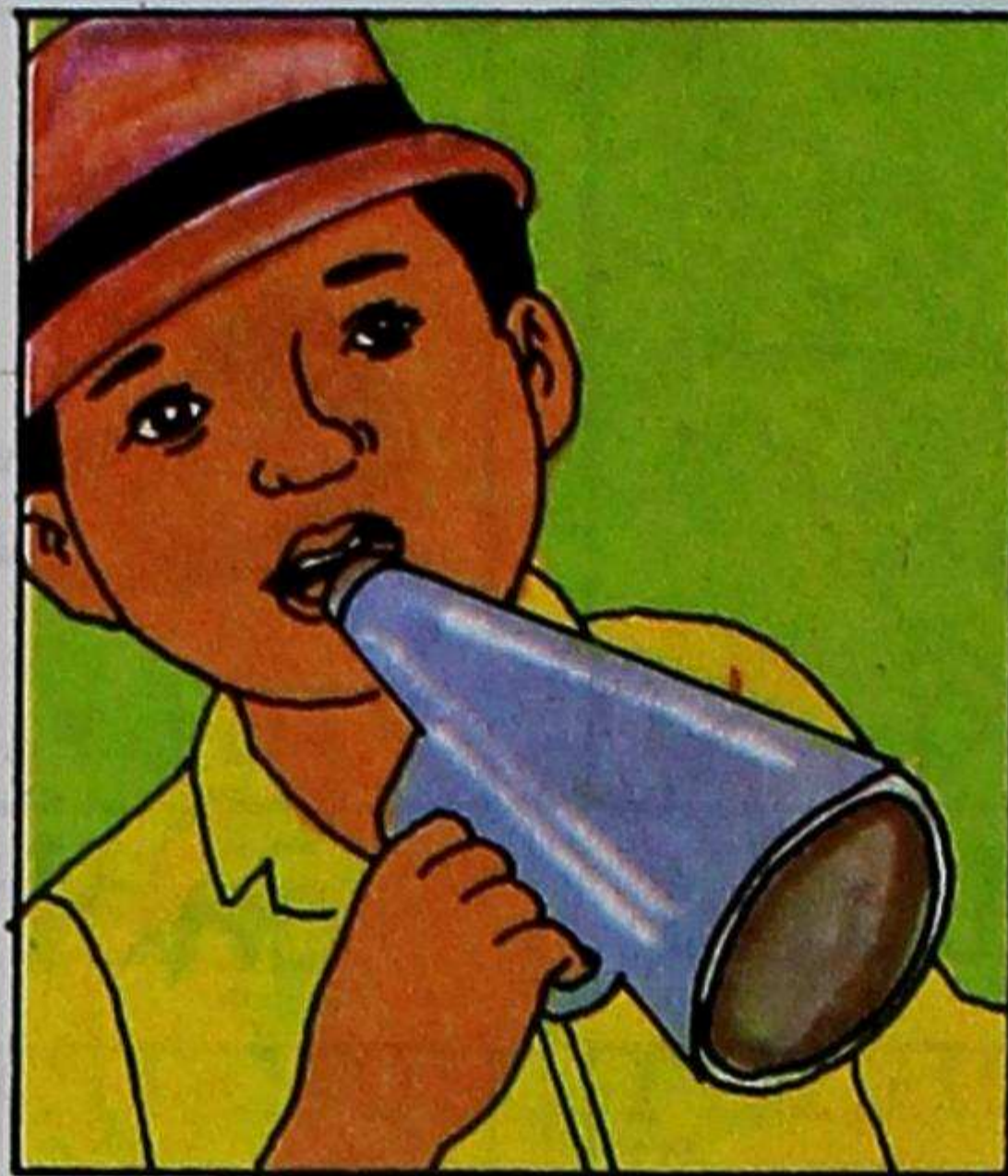

huillachic

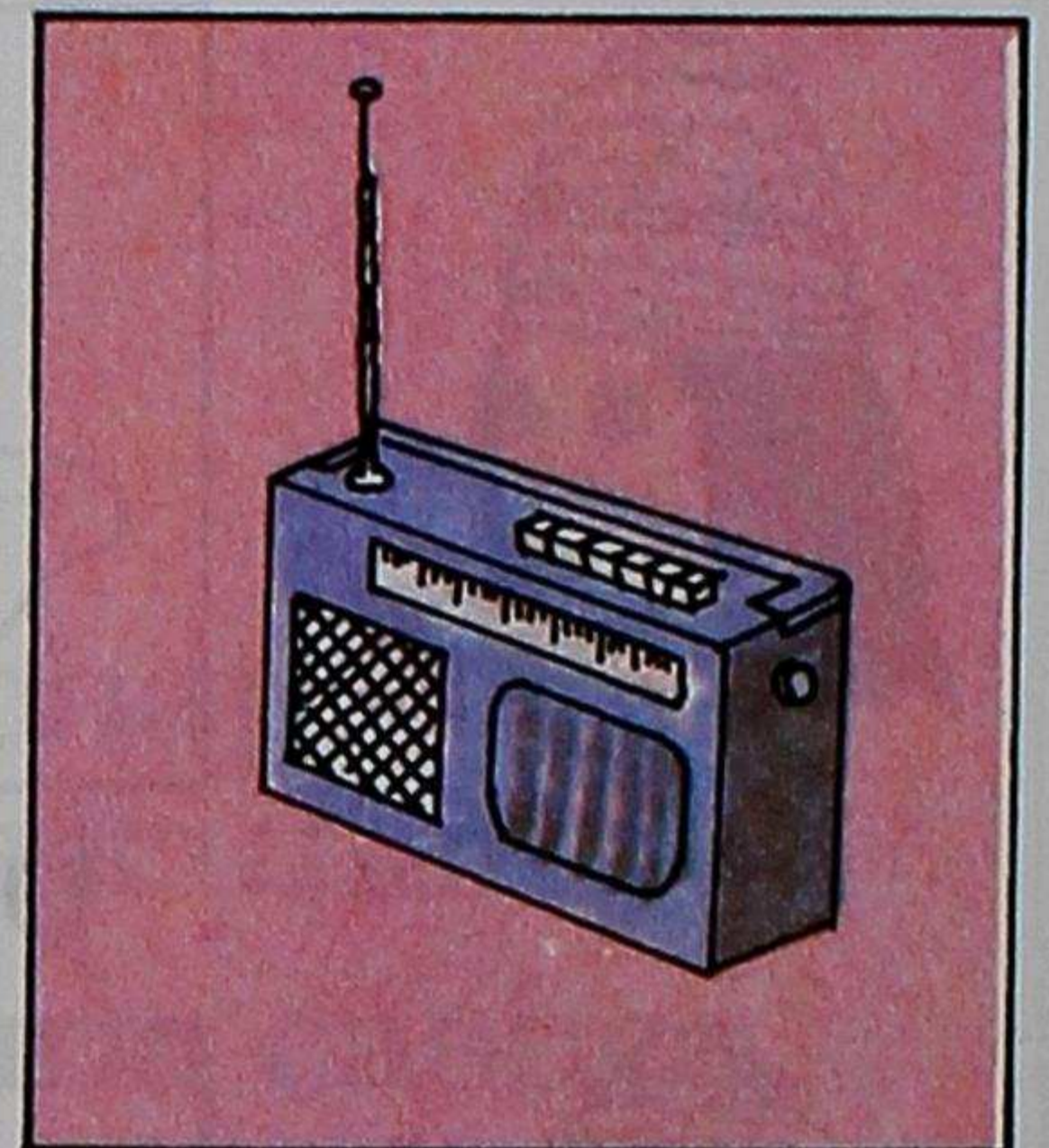

uyachic

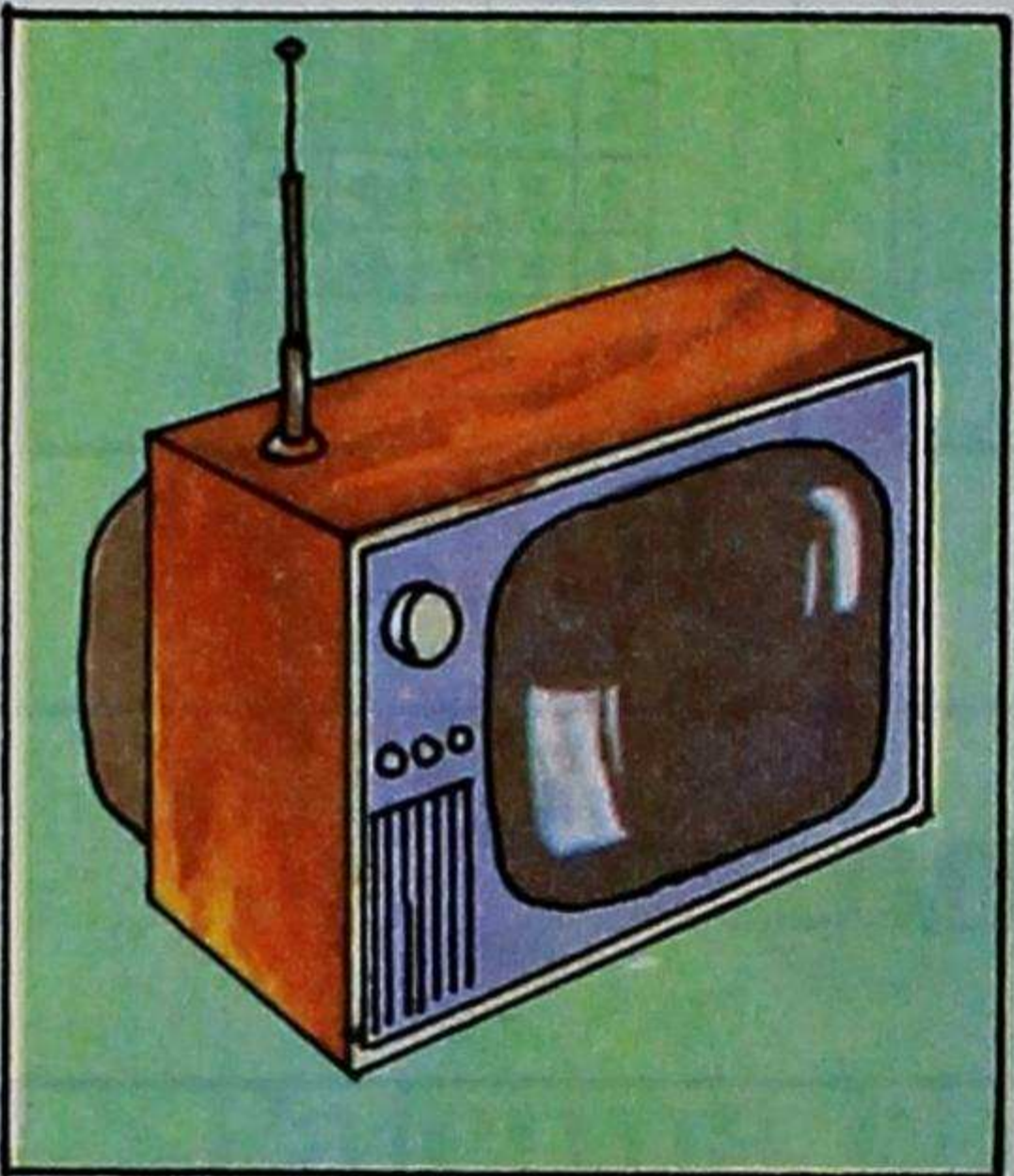

ricuchic

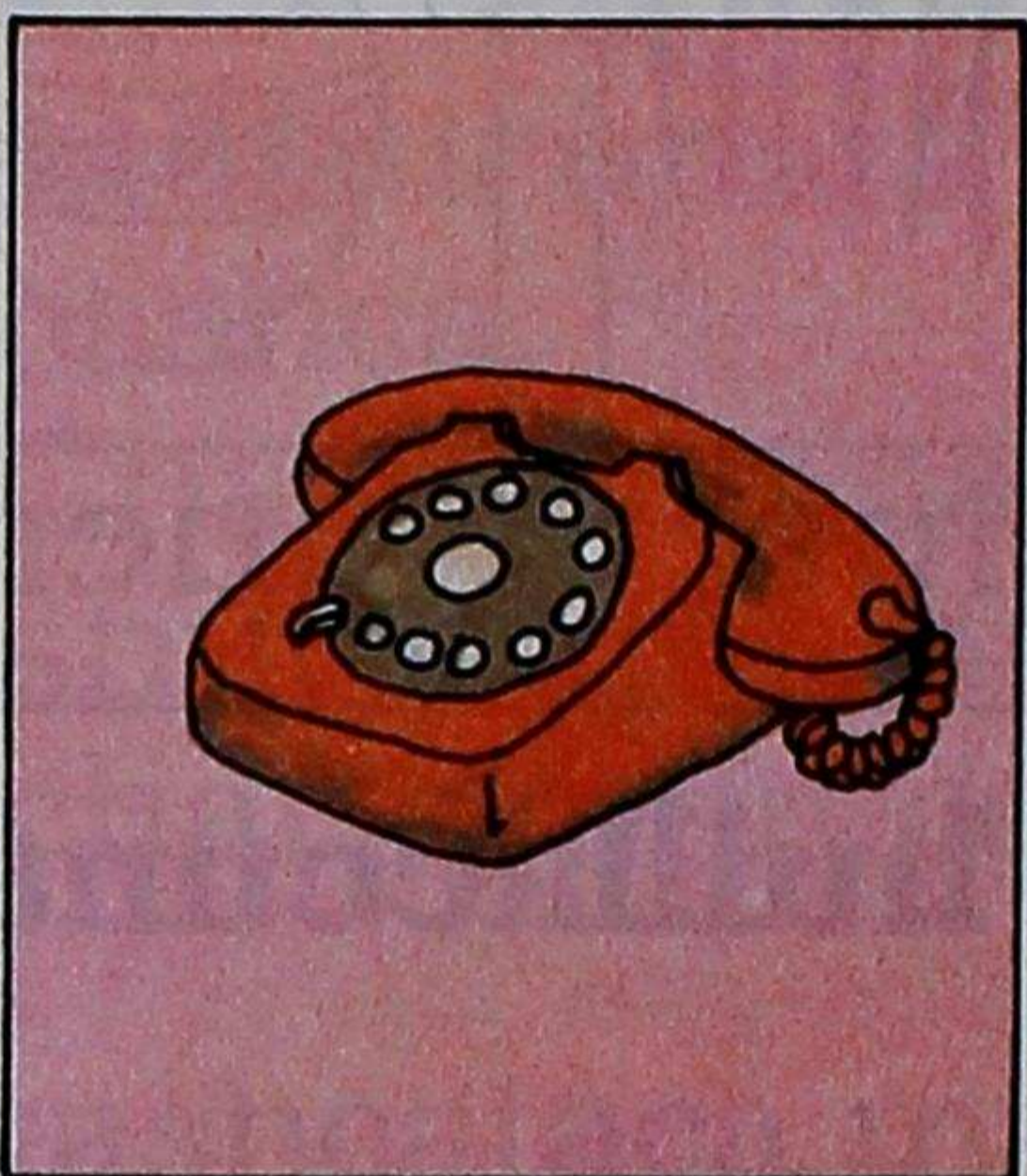

caru huillai

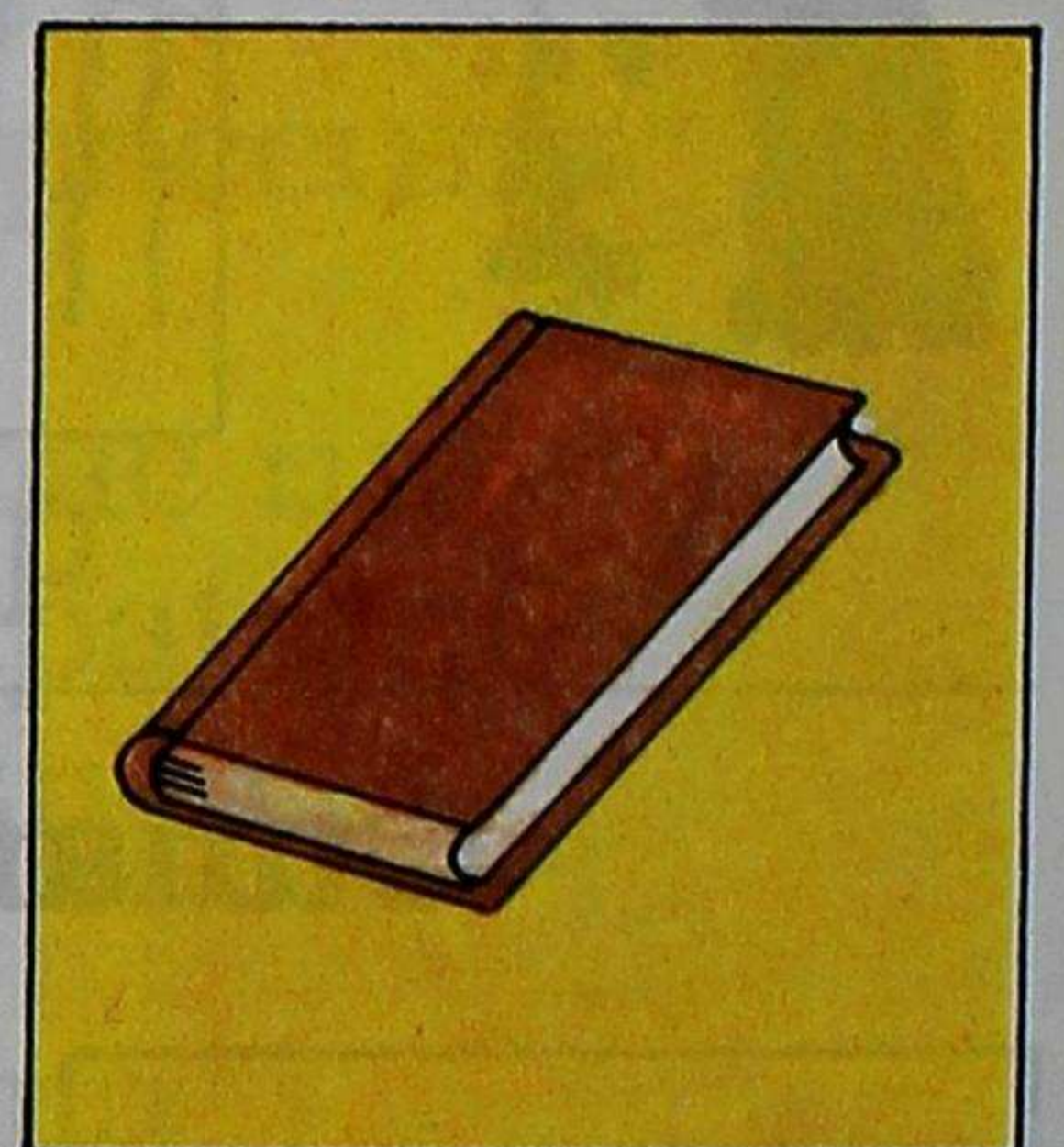

camu



rimachic



# Huillanamanta

uyana

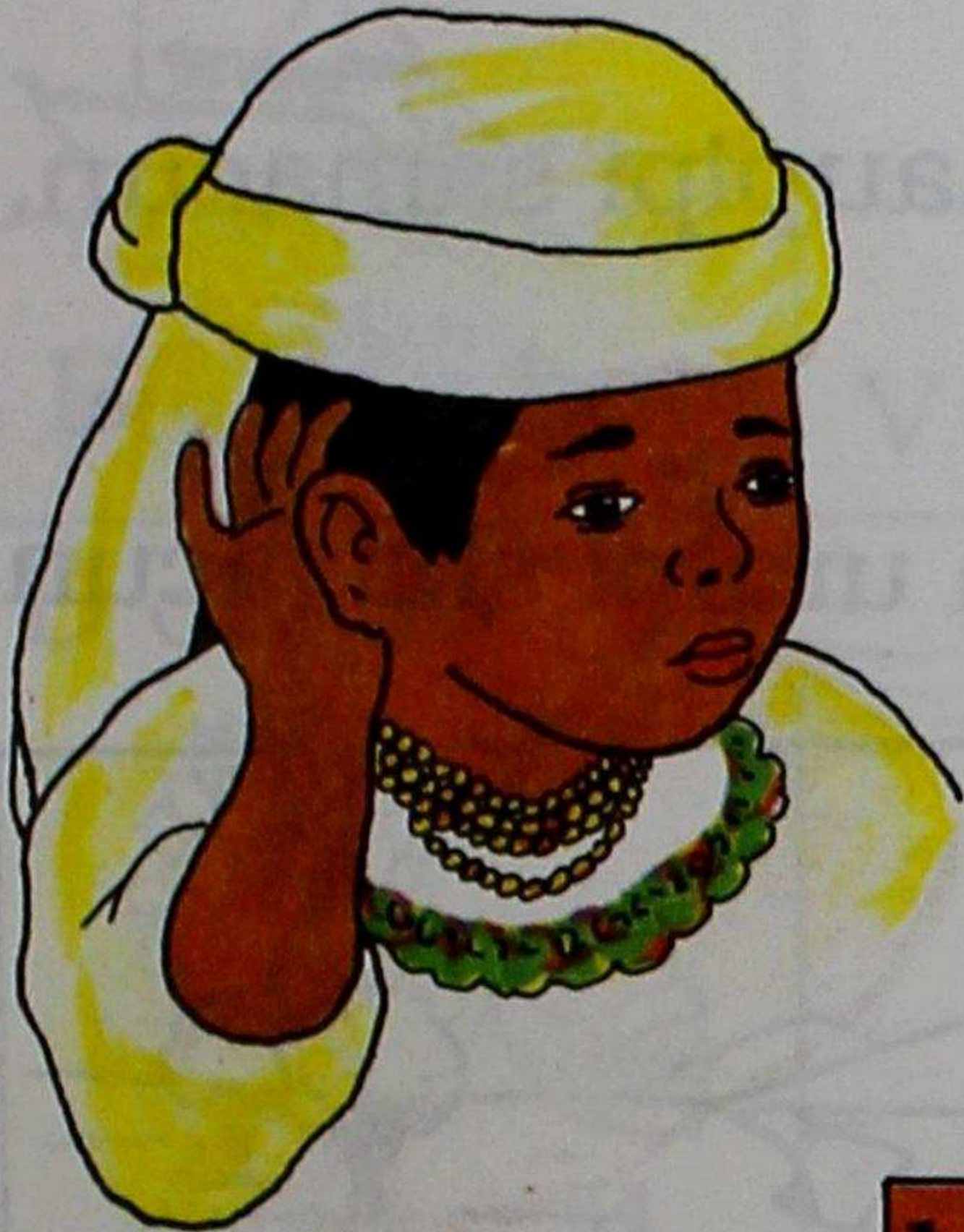

rimana



huillanacui

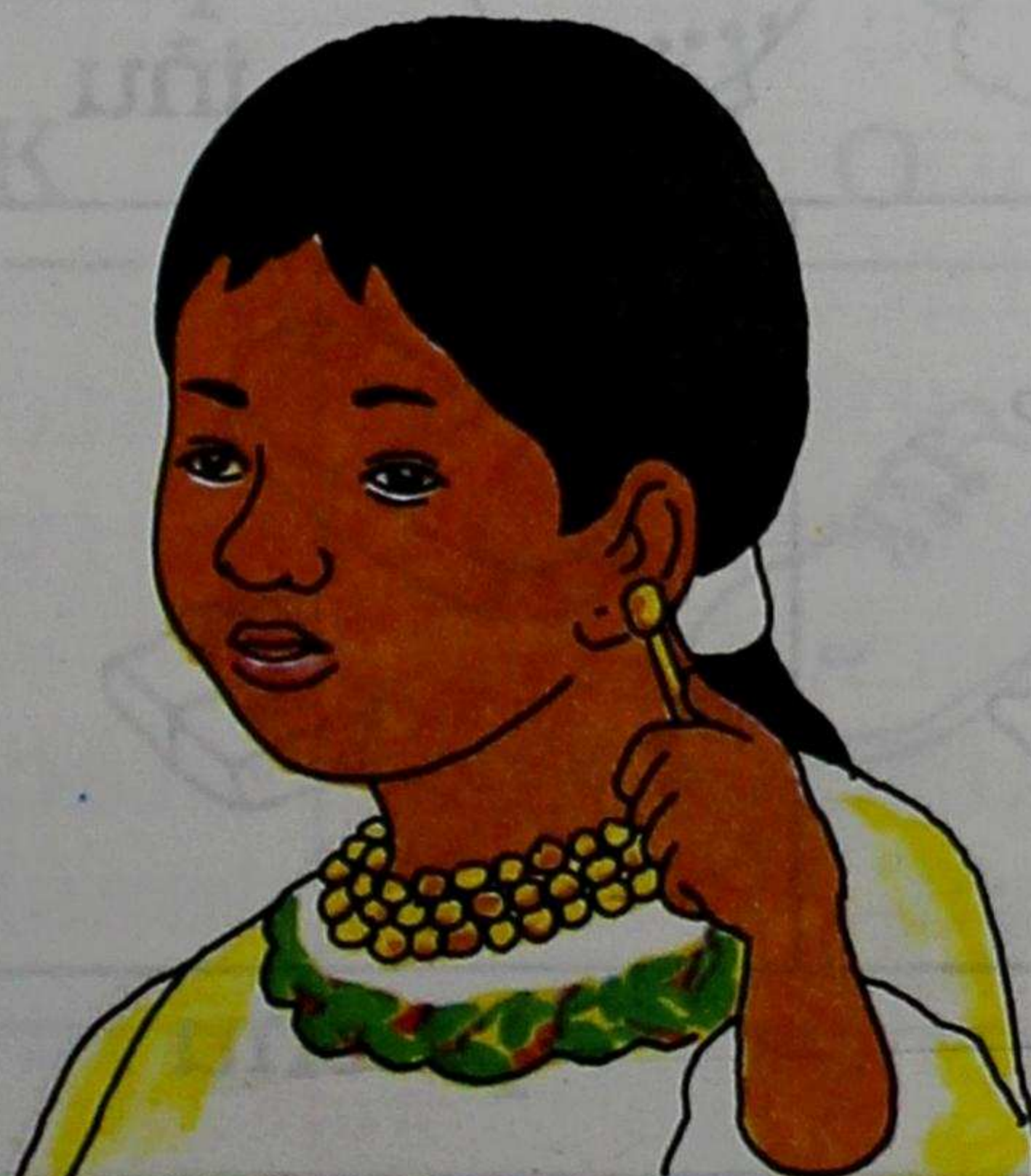
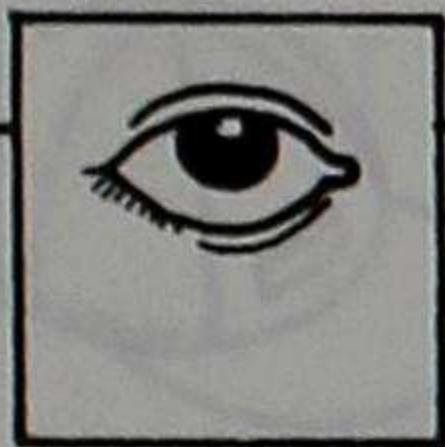

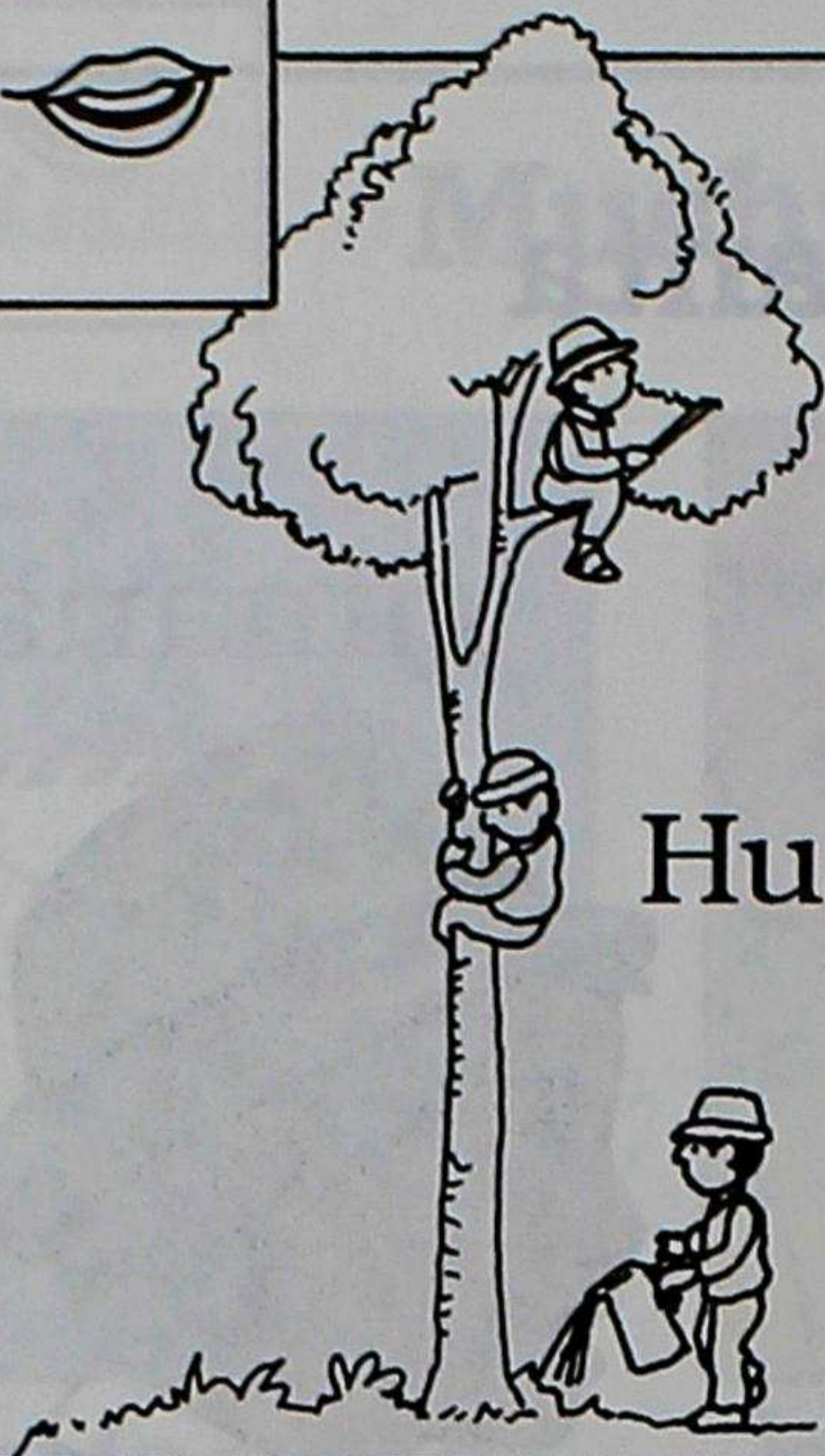
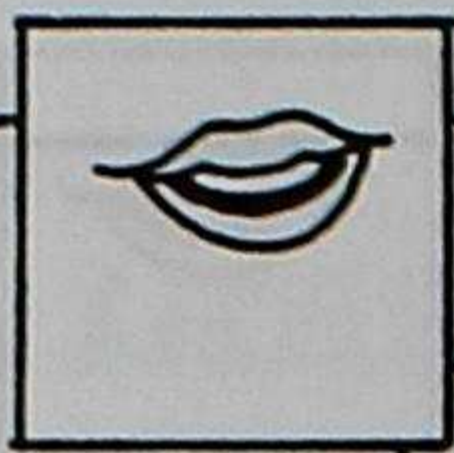

Huahuaca jahuapi tiyacun.

Huahuaca chaupipi samacun.

Huahuaca uraipi shayacun.

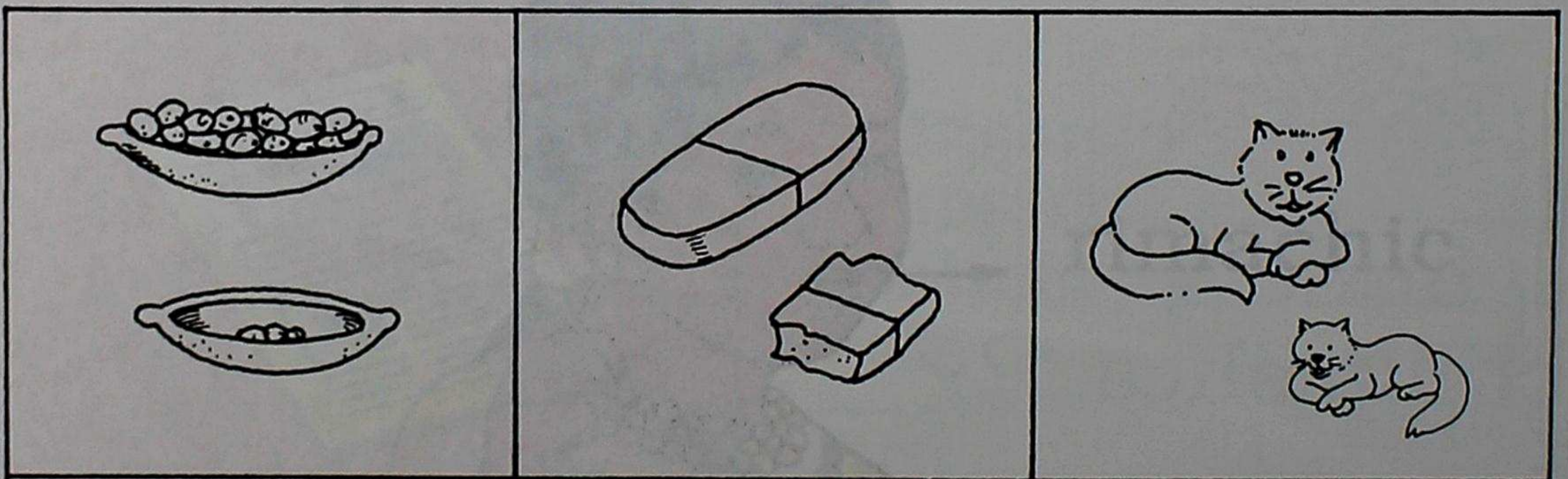
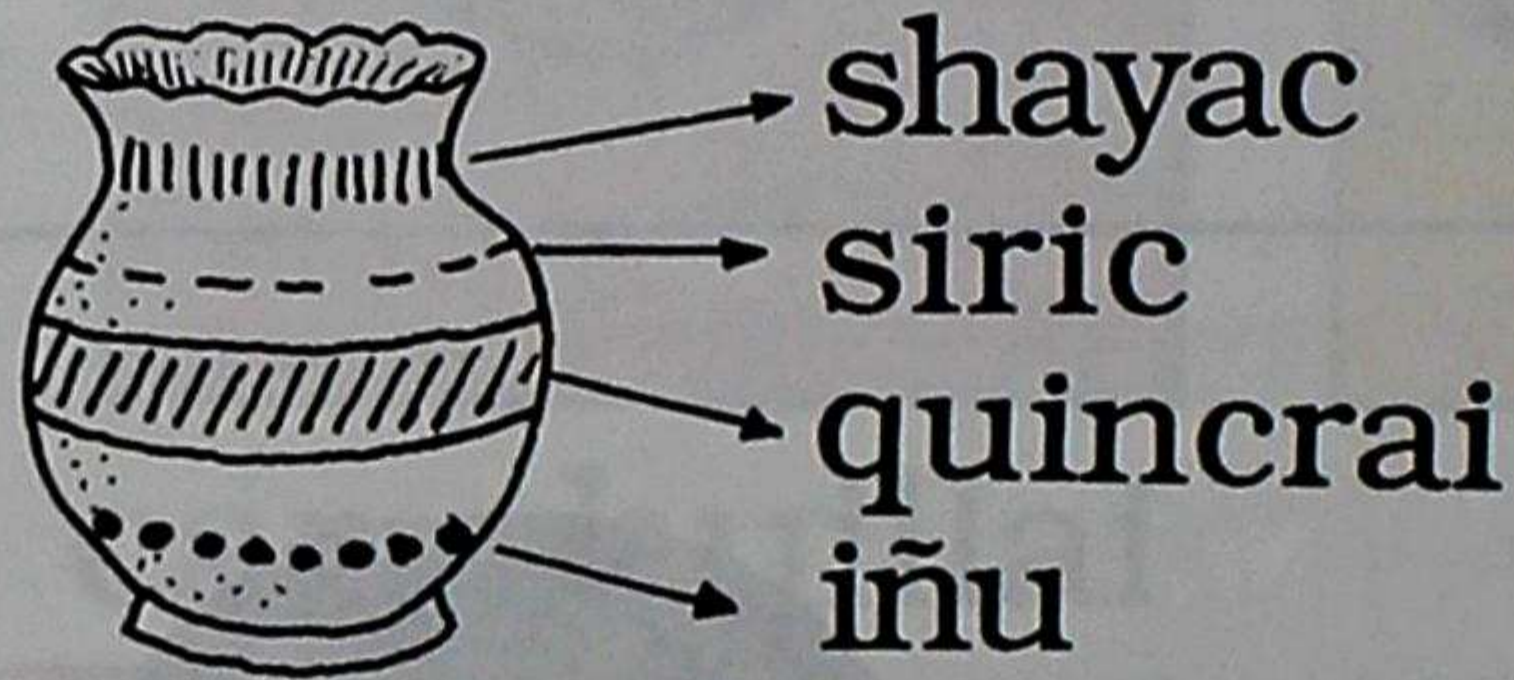
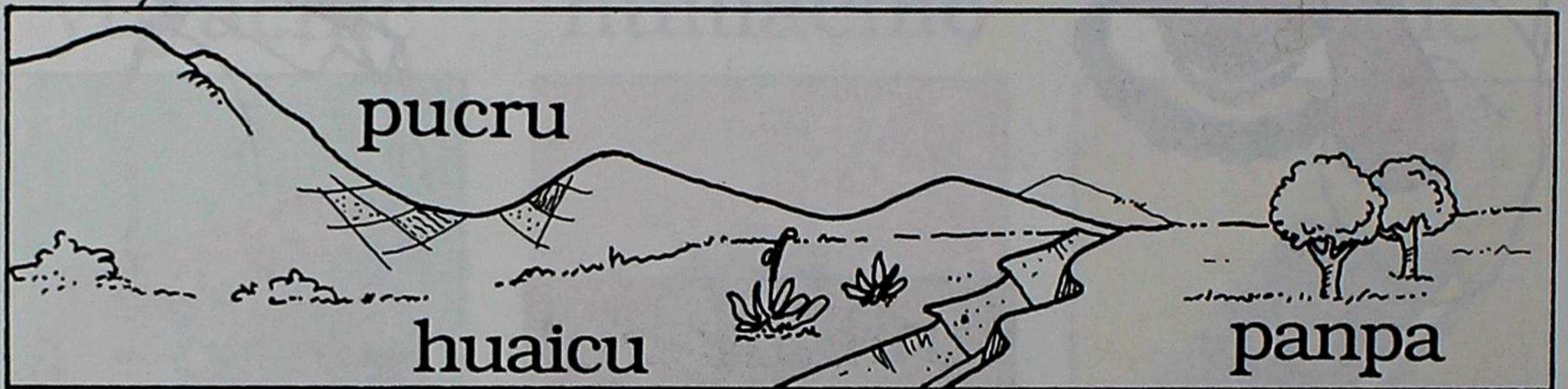





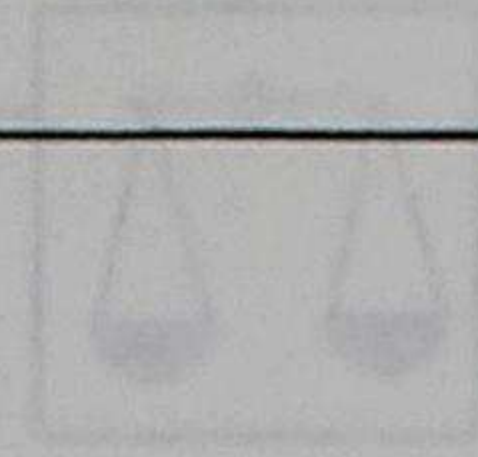
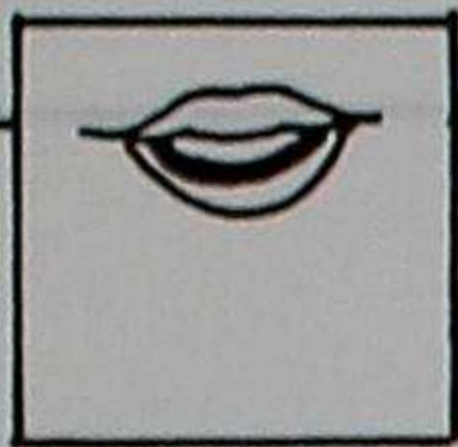

piti

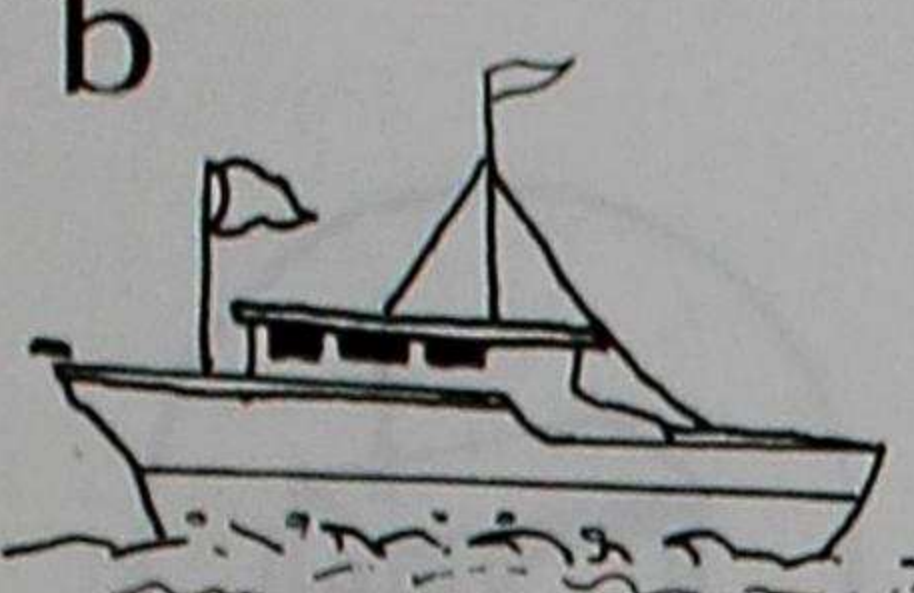
puchu

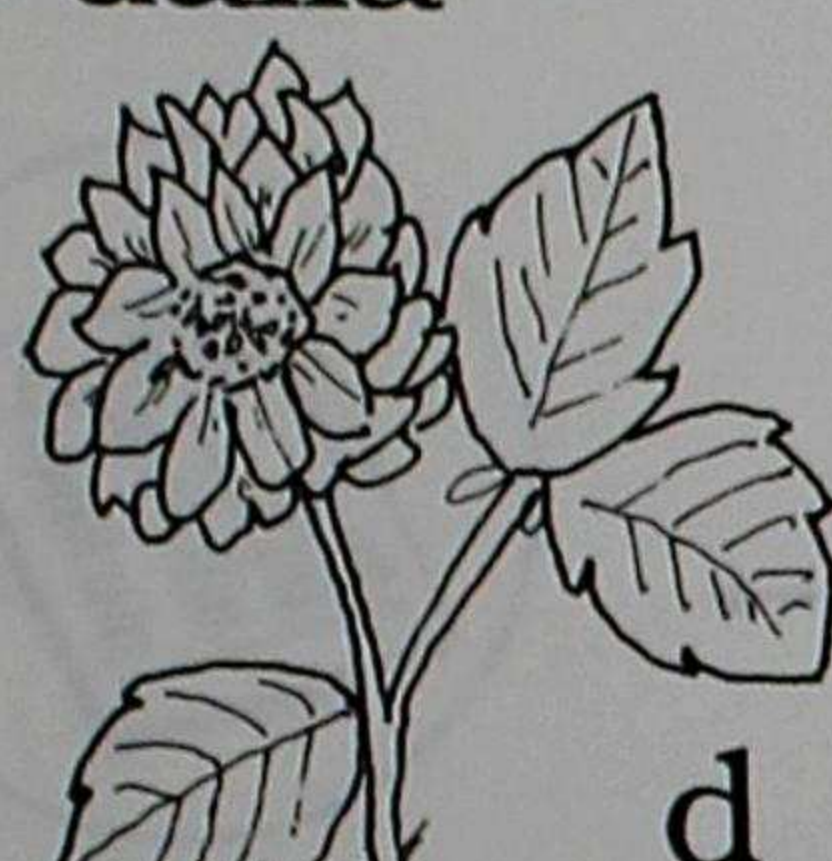
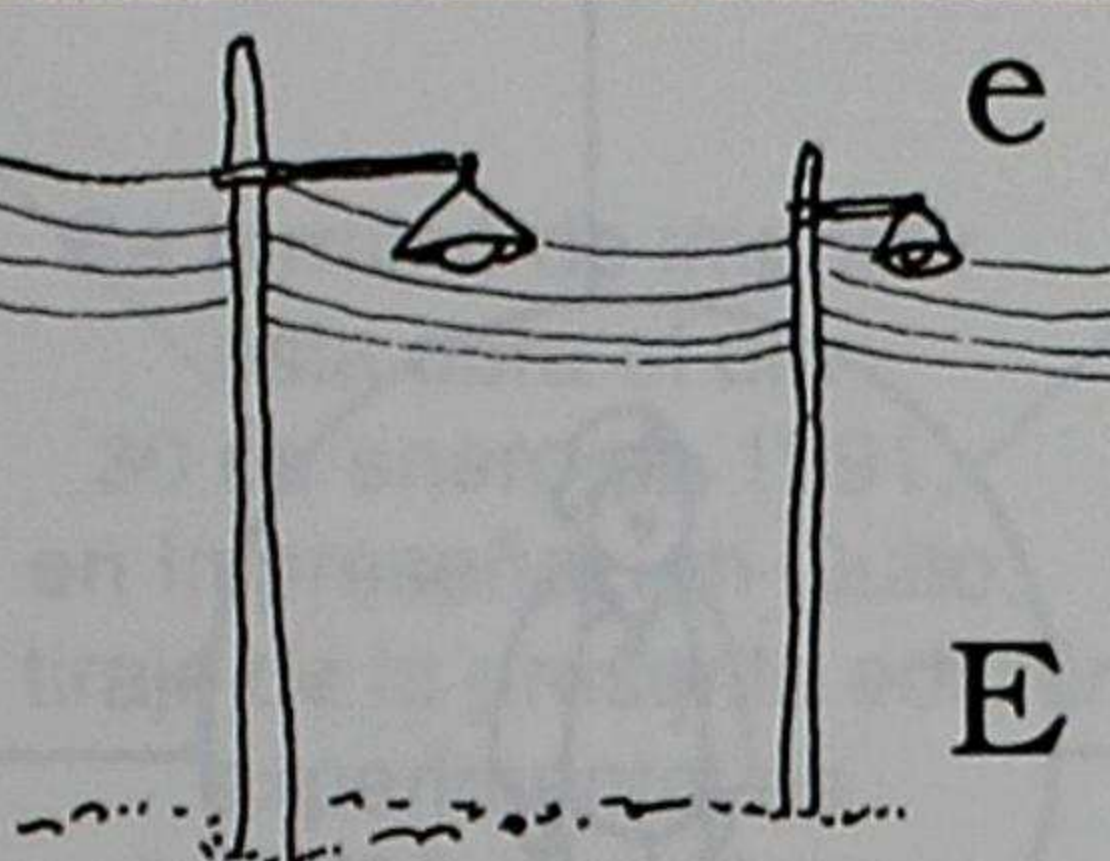
chuzu

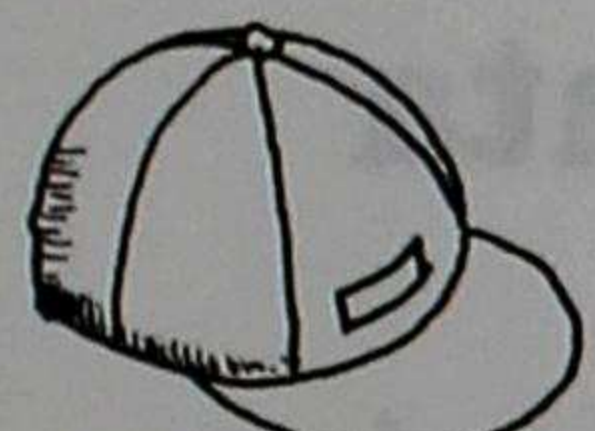
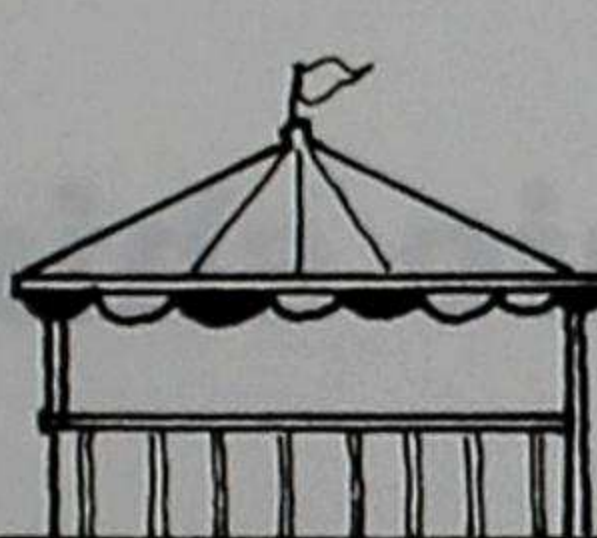

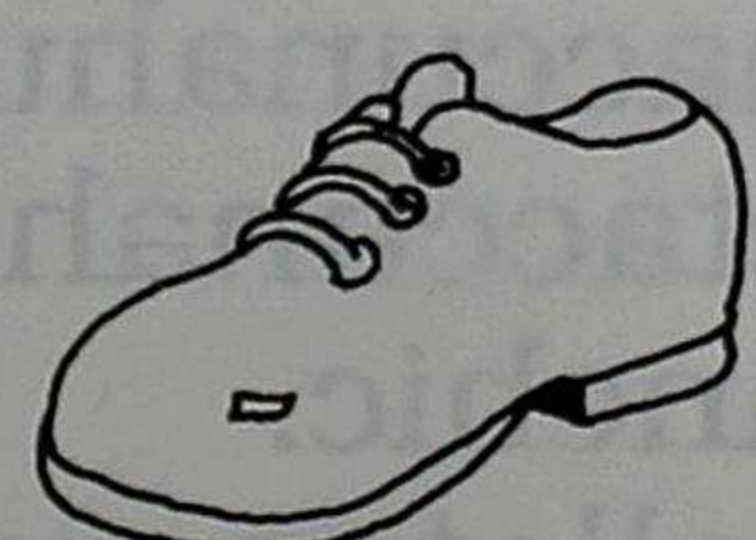
<p><b>b</b></p>  <p><b>B</b>      bote</p>	<p><b>v</b></p>  <p><b>V</b>      vino</p>	<p><b>c</b></p>  <p><b>C</b>      cepo</p>
<p><b>D</b> dalia</p>  <p><b>d</b></p>	<p><b>e</b></p>  <p><b>E</b></p> <p>electricidad</p>	<p><b>f</b></p>  <p><b>F</b>      alfalfa</p>
<p><b>g</b></p>  <p><b>G</b>      gorra</p>	<p><b>k</b></p>  <p><b>K</b>      kiosko</p>	<p><b>o</b></p>  <p><b>O</b>      oso</p>
<p><b>X</b></p>  <p><b>X</b></p>		<p><b>Z</b></p>  <p><b>Z</b>      zapato</p>

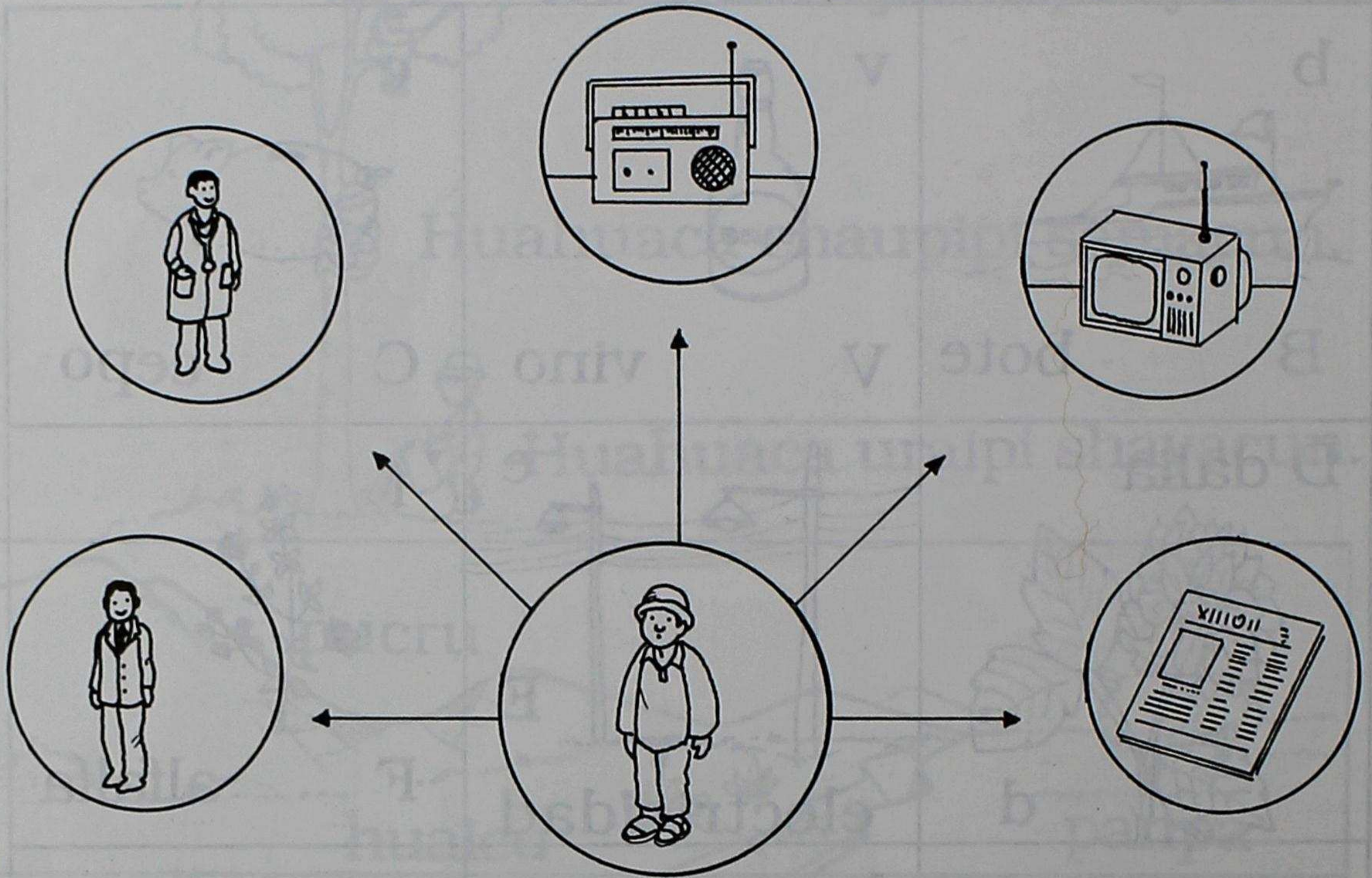
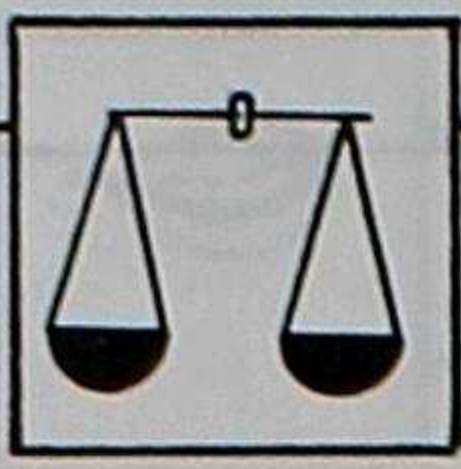

## Ñucanchic shimimanta

Ñucanchic shimitaca tucuicunami yachachun munanchic.

Ñucanchic shimita yachacpillami: pushaccunahuan, janpiccunahuan, shuctaccunahuanpash rimarita ushanchic.

Shinallatac yuyaicunataca: rimachicpi, uyachicpi ricuchicpipash ñucanchic shimipimi huillanchicman.

Se terminó de imprimir  
esta obra el día  
30 de enero de 1991,  
en Impreseñal, en Quito.  
El tiraje de la presente edición  
experimental es  
de 3.500 ejemplares.

Es una producción del Proyecto de Educación Bilingüe Intercultural,  
Montúfar 630 y Espejo, casilla 896-A, teléfono 215 053, Quito, Ecuador.

